

**\*TM 55-1520-240-10**

**TECHNICAL MANUAL  
MAINTENANCE MANUAL  
FOR  
ARMY CH-47D  
HELICOPTER  
(EIC: RCD)**



\*This manual supersedes TM 55-1520-240-10, dated 10 November 1982, including all changes.

DISTRIBUTION STATEMENT A: Approved for public release; distribution unlimited.

**HEADQUARTERS  
DEPARTMENT OF THE ARMY  
30 April 1992**

**WARNING DATA**

**TABLE OF CONTENTS**

**INTRODUCTION**

**DESCRIPTION AND  
OPERATION**

**AVIONICS**

**MISSION EQUIPMENT**

**OPERATING LIMITS  
AND RESTRICTIONS**

**WEIGHT/BALANCE  
AND LOADING**

**PERFORMANCE DATA**

**NORMAL PROCEDURES**

**EMERGENCY  
PROCEDURES**

**REFERENCES**

**ABBREVIATIONS  
AND TERMS**

**CONDITIONAL  
INSPECTIONS**

**ALPHABETICAL INDEX**

# URGENT

TM 55-1520-240-10  
C 19

CHANGE

NO. 19

HEADQUARTERS  
DEPARTMENT OF THE ARMY  
WASHINGTON, D.C., 15 FEBRUARY 2002

OPERATOR'S MANUAL  
FOR  
ARMY MODEL  
CH-47D HELICOPTERS  
(EIC: RCD)

DISTRIBUTION STATEMENT A: Approved for public release; distribution is unlimited.

TM 55-1520-240-10, 30 April 1992 is changed as follows:

1. Remove and insert pages as indicated below. New or changed text material is indicated by a vertical bar in the margin. An illustration change is indicated by a miniature pointing hand.

**Remove pages**

A and B

5-1 through 5-4

**Insert pages**

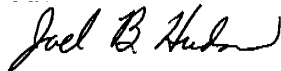
A and B

5-1 through 5-4

2. Retain this sheet in front of the manual for reference purposes.

**By Order of the Secretary of the Army:**

Official:



**JOEL B. HUDSON**  
*Administrative Assistant to the  
Secretary of the Army*

0204207

**ERIC K. SHINSEKI**  
*General, United States Army  
Chief of Staff*

DISTRIBUTION:

To be distributed in accordance with Initial Distribution Number (IDN) 310194, requirements for TM 55-1520-240-10.

# URGENT

TM 55-1520-240-10  
C 18

CHANGE  
NO. 18

HEADQUARTERS  
DEPARTMENT OF THE ARMY  
WASHINGTON, D.C., 15 OCTOBER 2001

OPERATOR'S MANUAL  
FOR  
ARMY MODEL  
CH-47D HELICOPTERS  
(EIC: RCD)

DISTRIBUTION STATEMENT A: Approved for public release; distribution is unlimited.

TM 55-1520-240-10, 30 April 1992 is changed as follows:

1. Remove and insert pages as indicated below. New or changed text material is indicated by a vertical bar in the margin. An illustration change is indicated by a miniature pointing hand.

**Remove pages**

A and B  
4-29 and 4-30  
8-3 and 8-4  
-----  
8-15 and 8-16

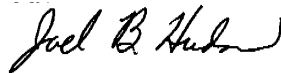
**Insert pages**

A and B  
4-29 and 4-30  
8-3 and 8-4  
8-4.1/(8-4.2 blank)  
8-15 and 8-16

2. Retain this sheet in front of the manual for reference purposes.

By Order of the Secretary of the Army:

Official: .....



**JOEL B. HUDSON**  
Administrative Assistant to the  
Secretary of the Army  
0129101

**ERIC K. SHINSEKI**  
General, United States Army  
Chief of Staff

DISTRIBUTION:

To be distributed in accordance with Initial Distribution Number (IDN) 310194, requirements for TM 55-1520-240-10.

# URGENT

TM 55-1520-240-10  
C 17

CHANGE  
NO. 17

HEADQUARTERS  
DEPARTMENT OF THE ARMY  
WASHINGTON, D.C., 31 JULY 2001

OPERATOR'S MANUAL  
FOR  
ARMY MODEL  
CH-47D HELICOPTERS  
(EIC: RCD)

DISTRIBUTION STATEMENT A: Approved for public release; distribution is unlimited.

TM 55-1520-240-10, 30 April 1992 is changed as follows:

1. Remove and insert pages as indicated below. New or changed text material is indicated by a vertical bar in the margin. An illustration change is indicated by a miniature pointing hand.

**Remove pages**

A and B  
2-1/(2-2 blank)  
8-9 and 8-10  
-----  
8-13 and 8-14  
-----  
9-12.1 and 9-12.2  
9-13 and 9-14

**Insert pages**

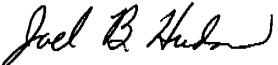
A and B  
2-1/(2-2 blank)  
8-9 and 8-10  
8-10.1/(8-10.2 blank)  
8-13 and 8-14  
8-14.1/(8-14.2 blank)  
9-12.1 and 9-12.2  
9-13 and 9-14

2. Retain this sheet in front of the manual for reference purposes.

By Order of the Secretary of the Army:

**ERIC K. SHINSEKI**  
General, United States Army  
Chief of Staff

Official:

  
**JOEL B. HUDSON**  
Administrative Assistant to the  
Secretary of the Army  
0120406

DISTRIBUTION:

To be distributed in accordance with Initial Distribution Number (IDN) 310194, requirements for TM 55-1520-240-10.



# URGENT

TM 55-1520-240-10  
C16

CHANGE

HEADQUARTERS  
DEPARTMENT OF THE ARMY  
WASHINGTON, D.C., 20 APRIL 2001

NO. 16

OPERATOR'S MANUAL  
FOR  
ARMY MODEL  
CH-47D HELICOPTERS  
(EIC:RCD)

DISTRIBUTION STATEMENT A: Approved for public release; distribution is unlimited,

TM 55-1520-240-10, 30 April 1992, is changed as follows:

1. Remove and insert pages as indicated below. New or changed text material is indicated by a vertical bar in the margin. An illustration change is indicated by a miniature pointing hand.

Remove pages

Insert pages

A and B

A and B

9-17 and 9-18

9-17 and 9-18

2. Retain this sheet in front of the manual for reference purposes.

**By Order of the Secretary of the Army**

Official



JOEL B. HUDSON

*Administrative Assistant to the  
Secretary of the Army*  
0110703

ERIC K. SHINSEKI  
General, United States Army  
Chief of Staff

DISTRIBUTION:

To be distributed in accordance with Initial Distribution Number (IDN) 310194, requirements for TM 55-1520-240-10.

# URGENT

TM 55-1520-240-10  
C 15

CHANGE  
NO. 15

HEADQUARTERS  
DEPARTMENT OF THE ARMY  
WASHINGTON, D.C., 29 DECEMBER 2000

OPERATOR'S MANUAL  
FOR  
ARMY MODEL  
CH-47D HELICOPTERS  
(EIC: RCD)

DISTRIBUTION STATEMENT A: Approved for public release; distribution is unlimited

TM 55-1520-240-10, 30 April 1992 is changed as follows:

1. Remove and insert pages as indicated below. New or changed text material is indicated by a vertical bar in the margin. An illustration change is indicated by a miniature pointing hand.

Remove pages

Insert pages

A and B  
9-17 and 9-18

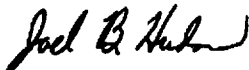
A and B  
9-17 and 9-18

2. Retain this sheet in front of the manual for reference purposes.

By Order of the Secretary of the Army:

ERIC K. SHINSEKI  
General, United States Army  
*Chief of Staff*

OFFICIAL:



JOEL B. HUDSON  
*Administrative Assistant to the  
Secretary of the Army*

0101001

DISTRIBUTION:

To be distributed in accordance with Initial Distribution Number (IDN) 310194, requirements for TM 55-1520-240-10.

# URGENT

TM 55-1520-240-10  
C 14

CHANGE

NO. 14

HEADQUARTERS  
DEPARTMENT OF THE ARMY  
WASHINGTON, D.C., 28 JULY 2000

## OPERATOR'S MANUAL FOR ARMY MODEL CH-47D HELICOPTERS (EIC: RCD)

DISTRIBUTION STATEMENT A: Approved for public release; distribution is unlimited

TM 55-1520-240-10, 30 April 1992 is changed as follows:

1. Remove and insert pages as indicated below. New or changed text material is indicated by a vertical bar in the margin. An illustration change is indicated by a miniature pointing hand.

### Remove pages

A and B  
i through iii/(iv blank)  
2-27 and 2-28  
2-85 and 2-86  
-----  
2-91 and 2-92  
4-39 and 4-40  
-----  
5-17/(5-18 blank)  
6-1 and 6-2  
6-37 and 6-38  
-----  
7-1 and 7-2  
8-3 through 8-6  
-----  
-----  
B-1 through B-4

### Insert pages

A and B  
i and ii  
2-27 and 2-28  
2-85 and 2-86  
2-90.1 and 2-90.2  
2-91 and 2-92  
4-39 and 4-40  
4-41 through 4-45/(4-46 blank)  
5-17/(5-18 blank)  
6-1 and 6-2  
6-37 and 6-38  
6-38.1/(6-38.2 blank)  
7-1 and 7-2  
8-3 through 8-6  
8-6.1/(8-6.2 blank)  
9-23/(9-24 blank)  
B-1 through B-4

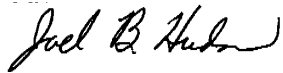
2. Retain this sheet in front of the manual for reference purposes.

TM 55-1520-240-10  
C14

By Order of the Secretary of the Army:

Official:

ERIC K. SHINSEKI  
*General, United States Army*  
*Chief of Staff*



JOEL B. HUDSON  
*Administrative Assistant to the*  
*Secretary of the Army*  
0017907

**DISTRIBUTION:**

To be distributed in accordance with Initial Distribution Number (IDN) 310194, requirements for TM 55-1520-240-10.

CHANGE  
NO. 13

HEADQUARTERS  
DEPARTMENT OF THE ARMY  
WASHINGTON, D.C., 15 MAY 2000

OPERATOR'S MANUAL  
FOR  
ARMY MODEL  
CH-47D HELICOPTERS  
(EIC: RCD)

DISTRIBUTION STATEMENT A: Approved for public release; distribution is unlimited

TM 55-1520-240-10, 30 April 1992 is changed as follows:

1. Remove and insert pages as indicated below. New or changed text material is indicated by a vertical bar in the margin. An illustration change is indicated by a miniature pointing hand.

**Remove pages**

A and B  
i and ii  
-----  
1-1/(1-2 blank)  
2-1/(2-2 blank)  
2-9 and 2-10  
2-10.1/(2-10.2 blank)  
2-11 and 2-12  
2-12.1/(2-12.2 blank)  
2-13 through 2-16  
-----  
2-21 and 2-22  
2-22.1/(2-22.2 blank)  
2-23 through 2-26  
-----  
2-33 and 2-34  
2-53/(2-54 blank)  
2-55/(2-56 blank)  
2-59/(2-60 blank)  
-----  
-----  
-----  
-----  
2-77 through 2-80  
-----  
3-17 and 3-18  
3-17.1 through 3-17.14 blank  
5-1 through 5-6  
-----  
5-7 and 5-8  
7-1 and 7-2  
-----

**Insert pages**

A and B  
i - ii  
iii/(iv blank)  
1-1/(1-2 blank)  
2-1/(2-2 blank)  
2-9 and 2-10  
-----  
2-11 and 2-12  
-----  
2-13 through 2-16  
2-16.1 through 2-16.5/(2-16.2 blank)  
2-21 and 2-22  
-----  
2-23 through 2-26  
2-26.1 through 2-26.5/(2-26.6 blank)  
2-33 and 2-34  
2-53/(2-54 blank)  
2-55/(2-56 blank)  
2-59/(2-60 blank)  
2-60.1/(2-60.2 blank)  
2-60.3/(2-60.4 blank)  
2-60.5/(2-60.6 blank)  
2-76.3/(2-76.4 blank)  
2-77 through 2-80  
3-16.1 through 3-16.14  
(3-17 blank)/3-18  
-----  
5-1 through 5-6  
5-6.1/(5-6.2 blank)  
5-7 and 5-8  
7-1 and 7-2  
7A-1 through 7A-112

**Remove Pages**

8-3 through 8-14  
9-1 and 9-2  
9-5 through 9-8  
-----  
9-9 through 9-12  
-----  
9-15 and 9-16  
9-17 and 9-18  
B-1 through B-4  
Index 1 through Index 8  
Index 8.1/(Index 8.2 blank)  
Index 9 through Index 10  
-----  
Index 11 and Index 12  
Index 12.1/(Index 12.2 blank)  
Index 13 through  
Index 15/(Index 16 blank)  
-----

**Insert Pages**

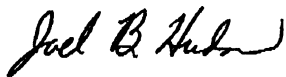
8-3 through 8-14  
9-1 and 9-2  
9-5 through 9-8  
9-8.1 through 9-8.4  
9-9 through 9-12  
9-12.1 and 9-12.2  
9-15 and 9-16  
9-17 and 9-18  
B-1 through B-4  
Index 1 through Index 8  
-----  
Index 9 through Index 10  
Index 10.1/(10.2 blank)  
Index 11 and Index 12  
-----  
Index 13 through Index 16  
Index 17 and Index 18

2. Retain this sheet in front of the manual for reference purposes.

**By Order of the Secretary of the Army:**

Official:

ERIC K. SHINSEKI  
*General, United States Army*  
*Chief of Staff*



JOEL B. HUDSON  
*Administrative Assistant to the*  
*Secretary of the Army*  
0012903

**DISTRIBUTION:**

To be distributed in accordance with Initial Distribution Number (IDN) 310194, requirements for TM 55-1520-240-10.

CHANGE  
NO. 12

HEADQUARTERS  
DEPARTMENT OF THE ARMY  
WASHINGTON, D.C., 15 March 1999

OPERATOR'S MANUAL  
FOR  
ARMY MODEL  
CH-47D HELICOPTERS  
(EIC: RCD)

DISTRIBUTION STATEMENT A: Approved for public release; distribution is unlimited.

TM 55-1520-240-10, 30 April 1992 is changed as follows:

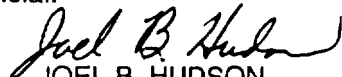
1. Remove and insert pages as indicated below. New or changed text material is indicated by a vertical bar in the margin. An illustration change is indicated by a miniature pointing hand.

Remove pages	Insert pages
-----	A and B
3-1 and 3-2	3-1 and 3-2
3-17 and 3-18	3-17 and 3-18
-----	3-17.1 through 3-17.13/ (3-17.14 blank)
Index 7 and Index 8	Index 7 and Index 8

2. Retain this sheet in front of the manual for reference purposes.

**By Order of the Secretary of the Army:**

Official:

  
JOEL B. HUDSON

Administrative Assistant to the  
Secretary of the Army

051968

DENNIS J. REIMER  
General, United States Army  
Chief of Staff

DISTRIBUTION:

To be distributed in accordance with Initial Distribution Number (IDN) 310194, requirements for  
TM 55-1520-240-10.

CHANGE

NO. 11

HEADQUARTERS  
DEPARTMENT OF THE ARMY  
WASHINGTON, D.C., 16 October 1998

OPERATOR'S MANUAL  
FOR  
ARMY MODEL  
CH-47D HELICOPTERS  
(EIC: RCD)

DISTRIBUTION STATEMENT A: Approved for public release; distribution is unlimited

TM 55-1520-240-10, 30 April 1992 is changed as follows:

1. Remove and insert pages as indicated below. New or changed text material is indicated by a vertical bar in the margin. An illustration change is indicated by a miniature pointing hand.

**Remove pages**

2-5 and 2-6  
2-11 and 2-12  
2-13 and 2-14  
2-65 and 2-66  
-----  
2-69 through 2-72  
2-93 and 2-94  
3-5 and 3-6  
8-3 and 8-4  
9-3 and 9-4  
Index 9 and Index 10

**Insert pages**

2-5 and 2-6  
2-11 and 2-12  
2-13 and 2-14  
2-65 and 2-66  
2-66.1/(2-66.2 blank)  
2-69 through 2-72  
2-93 and 2-94  
3-5 and 3-6  
8-3 and 8-4  
9-3 and 9-4  
Index 9 and Index 10

2. Retain this sheet in front of the manual for reference purposes.

**By Order of the Secretary of the Army:**

Official:

  
JOEL B. HUDSON

Administrative Assistant to the  
Secretary of the Army  
05594

DENNIS J. REIMER  
General, United States Army  
Chief of Staff

DISTRIBUTION:

To be distributed in accordance with Initial Distribution Number (IDN) 310194, requirements for TM 55-1520-240-10.



# URGENT

TM 55-1520-240-10  
C10

CHANGE  
NO. 10

HEADQUARTERS  
DEPARTMENT OF THE ARMY  
WASHINGTON, D.C., 31 August 1998

OPERATOR'S MANUAL  
FOR  
ARMY MODEL  
CH-47D HELICOPTERS  
(EIC:RCD)

DISTRIBUTION STATEMENT A: Approved for public release; distribution is unlimited,

TM 55-1520-240-10, 30 April 1992, is changed as follows:

1. Remove and insert pages as indicated below. New or changed text material is indicated by a vertical bar in the margin. An illustration change is indicated by a miniature pointing hand.

Remove pages

Insert pages

9-17 and 9-18

9-17 and 9-18

2. Retain this sheet in front of the manual for reference purposes.

**By Order of the Secretary of the Army**

Official



JOEL B. HUDSON

*Administrative Assistant to the  
Secretary of the Army*  
04855

DENNIS J. REIMER  
General, United States Army  
Chief of Staff

DISTRIBUTION:

To be distributed in accordance with Initial Distribution Number (IDN) 310194, requirements for TM 55-1520-240-10.

CHANGE

NO. 9

HEADQUARTERS  
DEPARTMENT OF THE ARMY  
WASHINGTON D.C., 27 April 1998

OPERATOR'S MANUAL  
FOR  
ARMY MODEL  
CH-47D HELICOPTERS  
(EIC: RCD)

DISTRIBUTION STATEMENT A: Approved for public release; distribution is unlimited

TM 55-1520-240-10, 30 April 1992, is changed as follows:

1. Remove and insert pages as indicated below. New or changed text material is indicated by a vertical bar in the margin. An illustration change is indicated by a miniature pointing hand.

## Remove pages

2-13 through 2-18  
2-21 and 2-22  
2-37 through 2-40  
2-47 through 2-50  
2-53/(2-54 blank)  
2-59/(2-60 blank)  
2-69 and 2-70  
2-76.1 and 2-76.2  
2-77 through 2-80  
2-91 through 2-94  
3-17 and 3-18  
4-1 and 4-2  
-----  
4-7 and 4-8  
4-29 and 4-30  
4-33 and 4-34  
5-1 and 5-2  
5-15 and 5-16  
5-17/(5-18 blank)  
6-3 and 6-4  
6-15 and 6-16  
6-29 through 6-32  
-----

## Insert pages

2-13 through 2-18  
2-21 and 2-22  
2-37 through 2-40  
2-47 through 2-50  
2-53/(2-54 blank)  
2-59/(2-60 blank)  
2-69 and 2-70  
2-76.1 and 2-76.2  
2-77 through 2-80  
2-91 through 2-94  
3-17 and 3-18  
4-1 and 4-2  
4-2.1 and 4-2.2  
4-7 and 4-8  
4-29 and 4-30  
4-33 and 4-34  
5-1 and 5-2  
5-15 and 5-16  
5-17/(5-18 blank)  
6-3 and 6-4  
6-15 and 6-16  
6-29 through 6-32  
6-32.1/(6-32.2 blank)

Remove pages

7-1 and 7-2  
8-3 and 8-4  
8-7 and 8-8  
8-8.1 and 8-8.2  
8-9 and 8-10  
9-5 and 9-6  
9-13 and 9-14  
9-14.1/(9-14.2 blank)  
9-15 and 9-16  
-----  
9-17 and 9-18  
Index 13 and Index 14

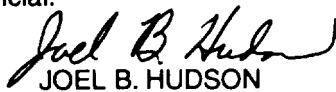
Insert pages

7-1 and 7-2  
8-3 and 8-4  
8-7 and 8-8  
8-8.1 and 8-8.2  
8-9 and 8-10  
9-5 and 9-6  
9-13 and 9-14  
9-14.1/(9-14.2 blank)  
9-15 and 9-16  
9-16.1/(9-16.2 blank)  
9-17 and 9-18  
Index 13 and Index 14

2. Retain this sheet in front of the manual for reference purposes.

By Order of the Secretary of the Army:

Official:



JOEL B. HUDSON

Administrative Assistant to the  
Secretary of the Army

04918

DENNIS J. REIMER  
General, United States Army  
Chief of Staff

DISTRIBUTION:

To be distributed in accordance with Initial Distribution Number (IDN) 310194, requirements for  
TM 55-1520-240-10.

CHANGE  
NO. 8

HEADQUARTERS  
DEPARTMENT OF THE ARMY  
WASHINGTON D.C., 2 February 1998

OPERATOR'S MANUAL  
FOR  
ARMY MODEL  
CH-47D HELICOPTER  
(EIC: RCD)

DISTRIBUTION STATEMENT A: Approved for public release; distribution is unlimited

TM 55-1520-240-10,30 April 1992, is changed as follows:

1. Remove and insert pages as indicated below. New or changed text material is indicated by a vertical bar in the margin. An illustration change is indicated by a miniature pointing hand.

Remove pages

i and ii

3-1 and 3-2

3-33 and 3-34

-----

Index 3 through Index 6

Insert pages

i and ii

3-1 and 3-2

3-33 and 3-34

3-34.1 through 3-34.22

Index 3 through Index 6

2. Retain this sheet in front of the manual for reference purposes.

By Order of the Secretary of the Army:

Official



JOEL B. HUDSON

Administrative Assistant to the  
Secretary of the Army  
04516

DENNIS J. REIMER  
General, United States Army  
Chief of Staff

DISTRIBUTION:

To be distributed in accordance with the Initial Distribution Number (IDN) 310194, requirements for TM 55-1520-240-10.

CHANGE  
NO. 7

HEADQUARTERS  
DEPARTMENT OF THE ARMY  
WASHINGTON, D.C., 25 June 1997

Operator's Manual  
For  
**ARMY MODEL  
CH-47D HELICOPTER  
(EIC:RCD)**

DISTRIBUTION STATEMENT A: Approved for public release; distribution is unlimited

TM 55-1520-240-10, 30 April 1992, is changed as follows:

1. Remove and insert pages as indicated below. New or changed text material is indicated by a vertical bar in the margin. An illustration change is indicated by a miniature pointing hand.

Remove pages  
2-7 through 2-10  
-----

2-33 and 2-34  
-----

2-53/(2-54 blank)  
2-55/(2-56 blank)  
2-59/(2-60 blank)

4-7 and 4-8  
-----

8-5 through 8-8  
-----

8-9 and 8-10

8-13 and 8-14

A-1/(A-2 blank)

B-1 through B-4

Index 7 and Index 8

Index 8.1/(Index 8.2 blank)

Insert pages

2-7 through 2-10

2-10.1/(2-10.2 blank)

2-33 and 2-34

2-34.1/(2-34.2 blank)

2-53/(2-54 blank)

2-55/(2-56 blank)

2-59/(2-60 blank)

4-7 and 4-8

4-8.1 through 4-8.10

8-5 through 8-8

8-8.1 and 8-8.2

8-9 and 8-10

8-13 and 8-14

A-1/(A-2 blank)

B-1 through B-4

Index 7 and Index 8

Index 8.1/(Index 8.2 blank)

2. Retain this sheet in front of manual for reference purposes.

**TM 55-1520-240-10**  
**C7**

**By Order of the Secretary of the Army:**

Official:

JOEL B. HUDSON  
Administrative Assistant to the  
Secretary of the Army  
03578

DENNIS J. REIMER  
General, United States Army  
Chief of Staff

**DISTRIBUTION:**

To be distributed in accordance with DA Form 12-31-E, block no. 0194, requirements for TM 55-1520-240-10.

CHANGE  
NO. 6

HEADQUARTERS  
DEPARTMENT OF THE ARMY  
WASHINGTON, D C., 27 February 1997

OPERATOR'S MANUAL  
FOR  
ARMY MODEL  
CH-47D HELICOPTER  
(EIC:RCD)

DISTRIBUTION STATEMENT A: Approved for public release; distribution is unlimited

TM 55-1520-240-10, 30 April 1992, is changed as follows:

1. Remove and insert pages as indicated below. New or changed text material is indicated by a vertical bar in the margin. An illustration change is indicated by a miniature pointing hand.

Remove pages  
i and ii  
2-9 through 2-12  
-----  
2-53/(2-54 blank)  
2-75 and 2-76  
-----  
3-1 and 3-2  
3-21 through 3-24  
3-29 through 3-32  
-----  
8-7 and 8-8  
Index 7 and Index 8  
-----  
Index 11 and Index12  
-----

Insert pages  
i and ii  
2-9 through 2-12  
2-12.1/(2-12.2 blank)  
2-53/(2-54 blank)  
2-75 and 2-76  
2-76.1 and 2-76.2  
3-1 and 3-2  
3-21 through 3-24  
3-29 through 3-32  
3-37 through 3-81/(3-82 blank)  
8-7 and 8-8  
Index 7 and Index 8  
Index 8.1/(Index 8.2 blank)  
Index 11 and Index12  
Index 12.1/(Index 12.2 blank)

2. Retain this sheet in front of manual for reference purposes.



TM 55-1520-240-10  
C6

**By Order of the Secretary of the Army:**

Official:

JOEL B. HUDSON  
Administrative Assistant to the  
Secretary of the Army  
03114

DENNIS J. REIMER  
General, United States Army  
Chief of Staff

To be distributed in accordance with DA Form 12-31-E, block no. 0194, requirements for TM 55-1520-240-10.

CHANGE  
NO. 5

HEADQUARTERS  
DEPARTMENT OF THE ARMY  
WASHINGTON, D. C., 17 April 1995

OPERATOR'S MANUAL  
FOR  
ARMY MODEL  
CH-47D HELICOPTERS  
(EIC: RCD)

DISTRIBUTION STATEMENT A: Approved for public release; distribution is unlimited

TM 55-1520-240-10,30 April 1992, is changed as follows:

1. Remove and insert pages as indicated below. New or changed text material is indicated by a vertical bar in the margin. An illustration change is indicated by a miniature pointing hand.

Remove pages

8-3 and 8-4  
8-11 and 8-12

Insert pages

8-3 and 8-4  
8-11 and 8-12

2. Retain this sheet in front of manual for reference purposes.

**By Order of the Secretary of the Army:**

Official:

  
JOEL B. HUDSON

Acting Administrative Assistant to the  
Secretary of the Army  
00116

GORDON R. SULLIVAN  
General, United States Army  
Chief of Staff

**DISTRIBUTION:**

To be distributed in accordance with DA Form 12-31-E, block no. 0194, requirements for  
TM 55-1520-240-10.

CHANGE

NO. 4

HEADQUARTERS  
DEPARTMENT OF THE ARMY  
WASHINGTON, D.C. 30 November 1994

OPERATORS MANUAL  
FOR  
ARMY MODEL  
CH-47D HELICOPTERS

DISTRIBUTION STATEMENT A: Approved for public release; distribution is unlimited

TM 55-1520-240-10,30 April 1992, is changed as follows:

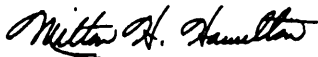
1. Remove and insert pages as indicated below. New or changed text material is indicated by a vertical bar in the margin. An illustration change is indicated by a miniature pointing hand.

Remove <i>pages</i>	Insert pages
a/(b blank)	a/(b blank)
2-1/(2-2 blank)	2-1/(2-2 blank)
2-21 and 2-22	2-21 and 2-22
---	2-22.1/(2-22.2 blank)
5-13 through 5-16	5-13 through 5-16
6-37 and 6-38	6-37 and 6-38
8-19/(8-20 blank)	8-19/(8-20 blank)
9-13 and 9-14	9-13 and 9-14
---	9-14.1/(9-14.2 blank)
9-15 and 9-16	9-15 and 9-16
Index 13 and Index 14	Index 13 and Index 14

2. Retain this sheet in front of manual for reference purposes.

By Order of the Secretary of the Army:

Official:

  
MILTON H. HAMILTON  
Administrative Assistant to the  
Secretary of the Army

07690

GORDON R. SULLIVAN  
General, United States Army  
Chief of Staff

DISTRIBUTION:

To be distributed in accordance with DA Form 12-31-E, block no. 0194, requirements for  
TM 55-1520-240-10.

CHANGE

NO. 3

HEADQUARTERS  
DEPARTMENT OF THE ARMY  
WASHINGTON, D.C., 30 SEPTEMBER 1994

Operators Manual  
for  
ARMY CH-47D HELICOPTER  
(EIC: RCD)

DISTRIBUTION STATEMENT A: Approved for public release; distribution is unlimited.

TM 55-1520-240-10, 30 April 1992, is changed as follows:

1. Remove and insert pages as indicated below. New or changed text material is indicated by a vertical bar in the margin. An illustration change is indicated by a miniature pointing hand.

Remove pages

2-85 and 2-86  
3-5 through 3-8  
-----  
5-1 and 5-2  
5-13 through 5-16  
6-17 through 6-20  
B-1 through B-4  
Index 13 and Index 14

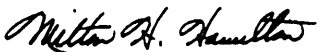
Insert pages

2-85 and 2-86  
3-5 through 3-8  
3-8.1 through 3-8.4  
5-1 and 5-2  
5-13 through 5-16  
6-17 through 6-20  
B-1 through B-4  
Index 13 and Index 14

2. Retain this sheet in front of manual for reference purposes.

By Order of the Secretary of the Army:

Official:

  
MILTON H. HAMILTON  
Administrative Assistant to the  
Secretary of the Army

07584

GORDON R. SULLIVAN  
General, United States Army  
Chief of Staff

DISTRIBUTION:

To be distributed in accordance with DA Form 12-31-E, block no. 0194, requirements for TM 55-1520-240-10.

# URGENT

TM 55-1520-240-10  
C2

CHANGE

NO. 2

HEADQUARTERS  
DEPARTMENT OF THE ARMY  
WASHINGTON, D. C., 1 March 1994

Operator's, Manual  
for  
**ARMY CH-47D HELICOPTER**  
**(EIC: RCD)**

DISTRIBUTION STATEMENT A: Approved for public release; distribution is unlimited

TM 55-1520-240-10, 30 April 1992, is changed as follows:

1. Remove and insert pages as indicated below. New or changed text material is indicated by a vertical bar in the margin. An illustration change is indicated by a miniature pointing hand.

Remove pages

3-7 and 3-8  
5-9 and 5-10  
8-3 through 8-8  
8-11 through 8-14

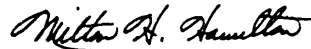
Insert pages

3-7 and 3-8  
5-9 and 5-10  
8-3 through 8-8  
8-11 through 8-14

2. Retain this sheet in front of manual for reference purposes.

By Order of the Secretary of the Army:

Official:



MILTON H. HAMILTON  
*Administrative Assistant to the  
Secretary of the Army*

05818

GORDON R. SULLIVAN  
*General, United States Army  
Chief of Staff*

DISTRIBUTION:

To be distributed in accordance with DA Form 12-31-E, block no. 0194, requirements for TM 55-1520-240-10.

CHANGE  
NO. 1

HEADQUARTERS  
DEPARTMENT OF THE ARMY  
WASHINGTON, D.C., 29 OCTOBER 1993

Operator's Manual  
for  
ARMY CH-47D HELICOPTER  
(EIC: RCD)

DISTRIBUTION STATEMENT A: Approved for public release; distribution is unlimited.

TM 55-1520-240-10, 30 April 1992, has been changed as follows:

1. Remove and insert pages as indicated below. New or changed text material is indicated by a vertical bar in the margin. An illustration change is indicated by a miniature pointing hand.

Remove pages

i and ii  
2-9 and 2-10  
2-67 and 2-68  
3-33 and 3-34  
4-1 through 4-4  
-----  
A-1/(A-2 blank)  
Index 11 through Index 14

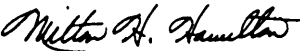
Insert pages

i and ii  
2-9 and 2-10  
2-67 and 2-68  
3-33 and 3-34  
4-1 through 4-4  
4-4.1 and 4-4.2  
A-1/(A-2 blank)  
Index 11 through Index 14

2. Retain this sheet in front of manual for reference purposes.

By Order of the Secretary of the Army:

Official:

  
MILTON H. HAMILTON  
Administrative Assistant to the  
Secretary of the Army

05611

GORDON R. SULLIVAN  
General, United States Army  
Chief of Staff

DISTRIBUTION:

To be distributed in accordance with DA Form 12-31-E, block no. 0194, requirements for TM 55-1520-240-10.

**WARNING PAGE**

Personnel performing operations, procedures, and practices which are included or implied in this technical manual shall observe the following warnings. Disregard of these warnings and precautionary information can cause serious injury or death.

**WARNINGS, CAUTIONS, NOTES**

Warnings, cautions, and notes are used in this manual to emphasize important and critical instructions, and are used for the following conditions:

**WARNING**

**An operating procedure, practice, etc., which, if not correctly followed, could result in personnel injury or loss of life.**

**CAUTION**

**An operating procedure, practice, etc., which, if not strictly observed, could result in damage to or destruction of equipment.**

**NOTE**

An operating procedure, condition, etc., which is essential to highlight.

**STARTING ENGINES**

Coordinate all cockpit actions with ground observer. Insure that wheels are chocked (if applicable), rotor and blast areas are clear, and fire guard is posted.

**GROUND OPERATION**

Engines will be started and operated only by authorized personnel.

**ROTOR BLADES**

Beware of moving rotor blades, particularly the blades of the forward rotor system.

**HIGH VOLTAGE**

All ground handling personnel must be informed of high voltage hazards when making external cargo hook-ups.

**FIRE EXTINGUISHER**

Exposure to high concentrations of fire extinguishing agents or decomposition products should be avoided. The liquid should not contact the skin. It may cause frostbite or low temperature burns.

**ARMAMENT**

Loaded weapons or weapons being loaded or unloaded, shall be pointed in a direction which offers the least exposure to personnel or property in the event of accidental firing. Personnel shall remain clear of the hazardous area of all loaded weapons.

**VERTIGO**

Turn the anti-collision lights off during flight through clouds. This will eliminate light reflections from the clouds, which could cause vertigo.

**CARBON MONOXIDE**

When smoke, suspected carbon monoxide fumes, or symptoms of anoxia exist, the crew should immediately ventilate the aircraft.

**HANDLING FUEL AND OIL**

Turbine fuels and lubricating oils contain additives that are poisonous and readily absorbed through the skin. Do not allow them to remain on skin longer than necessary.

**ELECTROMAGNETIC INTERFERENCE (EMI)**

No electrical/electronic devices of any sort, other than those described in this manual or appropriate airworthiness release and approved by USAATCOM, are to be operated by crewmembers or passengers during operation of this helicopter.

**RADIOACTIVE MATERIALS**

Instrument dials on CH-47 series aircraft contain radioactive materials. If an instrument is broken or becomes unsealed, avoid personal contact with the item. Use forceps or gloves made of rubber or polyethylene to pick up contaminated material. Place the material and the gloves in a plastic bag, seal the bag, and dispose of it as radioactive waste in accordance with AR 385-11 and TM 3-261. (Refer to TB 43-0108.)

**NOISE LEVELS**

Sound pressure levels in this aircraft during some operating conditions exceed the Surgeon General's hearing conservation criteria, as defined in TB MED 251. Hearing protection devices, such as the aviator helmet or ear plugs are required to be worn by all personnel in and around the aircraft during its operation.

**HAZARDOUS CARGO**

Items of cargo possessing dangerous physical properties, such as explosives, acids, flammables, etc., must be handled with extreme caution and in accordance with established regulations. Ref TM 38-250.

## LIST OF EFFECTIVE PAGES

Insert latest changed pages; dispose of superseded pages in accordance with regulations.

NOTE: On a changed page, the portion of the text affected by the latest change is indicated by a vertical line, or other change symbol, in the outer margin of the page. Changes to illustrations are indicated by miniature pointing hands. Changes to wiring diagrams are indicated by shaded areas.

Dates of issue for original and changed pages are:

Original	30 April 1992	Change 11	16 October 1998
Change 1	29 October 1993	Change 12	15 March 1999
Change 2	1 March 1994	Change 13	15 May 2000
Change 3	30 September 1994	Change 14	28 July 2000
Change 4	30 November 1994	Change 15	29 December 2000
Change 5	17 April 1995	Change 16	20 April 2001
Change 6	27 February 1997	Change 17	31 July 2001
Change 7	25 June 1997	Change 18	15 October 2001
Change 8	2 February 1998	Change 19	15 February 2002
Change 9	27 April 1998		
Change 10	31 August 1998		
Page	*Change	Page	*Change
No.	No.	No.	No.
Title . . . . .	0	2-35 through 2-37 . . . . .	0
a/b blank . . . . .	4	2-38 through 2-40 . . . . .	9
A and B . . . . .	19	2-41 through 2-47 . . . . .	0
i and ii . . . . .	14	2-48 and 2-49 . . . . .	9
iii/iv blank deleted . . . . .	14	2-50 through 2-52 . . . . .	0
1-1/1-2 blank . . . . .	13	2-53/2-54 blank . . . . .	13
2-1/2-2 blank . . . . .	17	2-55/2-56 blank . . . . .	13
2-3/2-4 blank . . . . .	0	2-57/2-58 blank . . . . .	0
2-5 . . . . .	11	2-59/2-60 blank . . . . .	13
2-6 . . . . .	0	2-60.1 - 2-60.6 blank . . . . .	13
2-7 . . . . .	7	2-61 through 2-64 . . . . .	0
2-8 . . . . .	0	2-65 and 2-66 . . . . .	11
2-9 and 2-10 . . . . .	13	2-66.1/2-66.2 blank . . . . .	11
2-10.1/2-10.2 blank del. . . . .	13	2-67 . . . . .	0
2-11 and 2-12 . . . . .	13	2-68 . . . . .	1
2-12.1/2-12.2 blank del. . . . .	13	2-69 . . . . .	0
2-13 through 2-16 . . . . .	13	2-70 and 2-71 . . . . .	11
2-16.1 through 2-16.4 . . . . .	13	2-72 through 2-74 . . . . .	0
2-16.5/2-16.6 blank . . . . .	13	2-75 and 2-76 . . . . .	6
2-17 and 2-18 . . . . .	9	2-76.1 . . . . .	9
2-19 and 2-20 . . . . .	0	2-76.2 . . . . .	6
2-21 and 2-22 . . . . .	13	2-76.3/2-76.4 blank . . . . .	13
2-22.1/2-22.2 blank del. . . . .	13	2-77 through 2-79 . . . . .	13
2-23 through 2-26 . . . . .	13	2-80 . . . . .	9
2-26.1 - 2-26.6 blank . . . . .	13	2-81 through 2-85 . . . . .	0
2-27 . . . . .	14	2-86 . . . . .	14
2-28 through 2-32 . . . . .	0	2-87 through 2-90 . . . . .	0
2-33 and 2-34 . . . . .	13	2-90.1 and 2-90.2 . . . . .	14
2-34.1/2-34.2 blank . . . . .	7	2-91 . . . . .	14

\*Zero in this column indicates an original page.



TM 5501520-240-10

Page No.	*Change No.	Page No.	*Change No.
2-92 and 2-93	0	6-30	0
2-94	11	6-31 and 6-32	9
2-95 and 2-96	0	6-32.1/6-32.2 blank	9
3-1	8	6-33 through 6-37	0
3-2	12	6-38	14
3-3 and 3-4	0	6-38.1/6-38.2 blank	14
3-5	3	6-39 through 6-46	0
3-6	11	7-1	13
3-7	3	7-2	14
3-8.1 through 3-8.4	3	7-3 through 7-114	0
3-9 through 3-16	0	7-115/7-116 blank	0
3-16.1 - 3-16.14	13	7A-1 - 7A-112	13
3-17 blank/3-18	13	8-1 and 8-2	0
3-17.1-3-17.14 blank del	13	8-3	14
3-19 and 3-20	0	8-4	18
3-21 through 3-23	6	8-4.1/8-4.2 blank	18
3-24 through 3-28	0	8-5 - 8-6.1/8-6.2 blank	14
3-29 through 3-31	6	8-7 and 8-8	13
3-32 and 3-33	0	8-9	17
3-34	8	8-10	13
3-34.1 through 3-34.22	8	8-10.1/8-10.2 blank	17
3-35 and 3-36	0	8-11 through 8-13	13
3-37 through 3-82 blank	6	8-14	17
4-1 through 4-2.	9	8-14.1/8-14.2 blank	17
4-3 through 4-4.2	1	8-15	18
4-5 and 4-6	0	8-16 through 8-18	0
4-7 and 4-8	9	8-19/8-20 blank	4
4-8.1 through 4-8.10	7	9-1 and 9-2	13
4-9 through 4-28	0	9-3	11
4-29	18	9-4	0
4-30 through 4-32	0	9-5 through 9-8.4	13
4-33	9	9-9	13
4-34 through 4-39	0	9-10	0
4-40 through 4-44	14	9-11 through 9-12.1	13
4-45/4-46 blank	14	9-12.2	17
5-1	0	9-13	17
5-2 and 5-3	19	9-14	9
5-4 through 5-6	13	9-14.1/9-14.2 blank	9
5-6.1/5-6.2 blank	13	9-15	9
5-7	13	9-16	13
5-8	0	9-16.1/9-16.2 blank	9
5-9	2	9-17	16
5-10 through 5-13	0	9-18 through 9-22	0
5-14	4	9-23/9-24 blank	14
5-15	9	A-1/A-2 blank	7
5-16	0	B-1	7
5-17/5-18 blank	14	B-2 through B-4	14
6-1	0	C-1 through C-4 blank	0
6-2	14	Index 1 - Index 8	13
6-3	0	Index 8.1 - 8.2 blank del.	13
6-4	9	Index 9 - Index 10	13
6-5 through 6-17	0	Index 10.1/10.2 blank	13
6-18 and 6-19	3	Index 11 and Index 12	13
6-20 through 6-28	0	Index 12.1/12.2 blank del.	13
6-29	9	Index 13 - Index 18	13

\*Zero in this column indicates an original page.

**OPERATOR'S MANUAL  
for  
ARMY CH-47D HELICOPTER**

**REPORTING OF ERRORS AND RECOMMENDING IMPROVEMENTS**

You can help improve this manual. If you find any mistakes or if you know of a way to improve the procedures, please let us know. Mail your letter, DA Form 2028 (Recommended changes to Publications and Blank Forms), or DA Form 2028-2 located in back of this manual direct to: Commander, U.S. Army Aviation and Missile Command, ATTN: AMSAM-MMC-LS-LP, Redstone Arsenal, AL 35898-5230. A reply will be furnished to you. You may also send in your comments electronically to our e-mail address: ls-lp@redstone.army.mil or by fax 256-842-6546/DSN 788-6546. Instruction for sending an electronic 2028 may be found at the back of this manual immediately preceding the hard copy 2028.

**TABLE OF CONTENTS**

		<b>Page</b>
CHAPTER 1	INTRODUCTION .....	1-1
CHAPTER 2	AIRCRAFT AND SYSTEMS DESCRIPTION AND OPERATION .....	2-1
SECTION I	HELICOPTER .....	2-1
SECTION II	EMERGENCY EQUIPMENT .....	2-17
SECTION III	ENGINES AND RELATED SYSTEMS .....	2-21
SECTION IV	FUEL SYSTEM .....	2-27
SECTION V	FLIGHT CONTROLS .....	2-33
SECTION VI	HYDRAULIC SYSTEMS .....	2-38
SECTION VII	POWER TRAIN SYSTEM .....	2-41
SECTION VIII	ROTOR SYSTEM .....	2-45
SECTION IX	UTILITY SYSTEMS .....	2-46
	HEATING, VENTILATION, COOLING, AND ENVIRONMENTAL	
SECTION X	CONTROL SYSTEMS .....	2-50
SECTION XI	ELECTRICAL POWER SUPPLY AND DISTRIBUTION SYSTEMS .....	2-52
SECTION XII	AUXILIARY POWER UNIT .....	2-62
SECTION XIII	LIGHTING (NVG) .....	2-65
SECTION XIV	FLIGHT INSTRUMENTS .....	2-72
SECTION XV	SERVICING, PARKING, AND MOORING .....	2-80
CHAPTER 3	AVIONICS .....	3-1
SECTION I	GENERAL .....	3-1
SECTION II	COMMUNICATIONS .....	3-3
SECTION III	NAVIGATION EQUIPMENT .....	3-18
SECTION IV	TRANSPONDERS .....	3-34
CHAPTER 4	MISSION EQUIPMENT .....	4-1
SECTION I	MISSION AVIONICS .....	4-1
SECTION II	ARMAMENT .....	4-9
SECTION III	CARGO HANDLING SYSTEMS .....	4-18
SECTION IV	EXTENDED RANGE FUEL SYSTEM (ERFS) AND ERFS II .....	4-40
CHAPTER 5	OPERATING LIMITS AND RESTRICTIONS .....	5-1
SECTION I	GENERAL .....	5-1
SECTION II	SYSTEM LIMITS .....	5-2
SECTION III	POWER LIMITS .....	5-7

	<b>Page</b>
SECTION IV	LOADING LIMITS . . . . . 5-8
SECTION V	AIRPEED LIMITS . . . . . 5-9
SECTION VI	MANEUVERING LIMITS . . . . . 5-13
SECTION VII	ENVIRONMENTAL RESTRICTIONS . . . . . 5-14
SECTION VIII	WATER OPERATION LIMITATIONS . . . . . 5-16
SECTION IX	ADDITIONAL LIMITATIONS . . . . . 5-17
CHAPTER 6	WEIGHT/BALANCE AND LOADING . . . . . 6-1
SECTION I	GENERAL . . . . . 6-1
SECTION II	WEIGHT AND BALANCE . . . . . 6-3
SECTION III	FUEL/OIL . . . . . 6-4
SECTION IV	PERSONNEL . . . . . 6-6
SECTION V	MISSION EQUIPMENT . . . . . 6-16
SECTION VI	CARGO LOADING . . . . . 6-18
SECTION VII	LOADING LIMITS . . . . . 6-45
CHAPTER 7	<b>712</b> PERFORMANCE DATA . . . . . 7-1
SECTION I	INTRODUCTION . . . . . 7-1
SECTION II	EMERGENCY TORQUE AVAILABLE . . . . . 7-4
SECTION III	MAXIMUM TORQUE AVAILABLE . . . . . 7-6
SECTION IV	CONTINUOUS TORQUE AVAILABLE . . . . . 7-10
SECTION V	HOVER . . . . . 7-12
SECTION VI	TAKEOFF . . . . . 7-16
SECTION VII	CRUISE . . . . . 7-18
SECTION VIII	DRAG . . . . . 7-104
SECTION IX	CLIMB-DESCENT . . . . . 7-106
SECTION X	FUEL FLOW . . . . . 7-110
SECTION XI	AIRPEED CALIBRATION . . . . . 7-114
CHAPTER 7A	<b>714A</b> PERFORMANCE DATA . . . . . 7A-1
SECTION I	INTRODUCTION . . . . . 7A-1
SECTION II	CONTINGENCY TORQUE AVAILABLE . . . . . 7A-4
SECTION III	MAXIMUM TORQUE AVAILABLE . . . . . 7A-6
SECTION IV	CONTINUOUS TORQUE AVAILABLE . . . . . 7A-8.2
SECTION V	HOVER . . . . . 7A-10
SECTION VI	TAKEOFF . . . . . 7A-14
SECTION VII	CRUISE . . . . . 7A-16
SECTION VIII	DRAG . . . . . 7A-102
SECTION IX	CLIMB-DESCENT . . . . . 7A-104
SECTION X	FUEL FLOW . . . . . 7A-108
SECTION XI	AIRPEED CALIBRATION . . . . . 7A-110.2
CHAPTER 8	NORMAL PROCEDURES . . . . . 8-1
SECTION I	MISSION PLANNING . . . . . 8-1
SECTION II	OPERATING PROCEDURES AND MANEUVERS . . . . . 8-3
SECTION III	FLIGHT CHARACTERISTICS . . . . . 8-15
SECTION IV	ADVERSE ENVIRONMENTAL CONDITIONS . . . . . 8-16
CHAPTER 9	EMERGENCY PROCEDURES . . . . . 9-1
SECTION I	HELICOPTER SYSTEMS . . . . . 9-1
SECTION II	MISSION EQUIPMENT . . . . . 9-22
APPENDIX A	REFERENCES . . . . . A-1
APPENDIX B	GLOSSARY . . . . . B-1
APPENDIX C	CONDITIONAL INSPECTIONS . . . . . C-1
ALPHABETICAL INDEX	Index-1

# CHAPTER 1

## INTRODUCTION

### 1-1. General.

These instructions are for use by the operator. They apply to CH-47D helicopters.

### 1-2. Helicopter Description.

This manual contains the complete operating instructions and procedures for the CH-47D helicopters. It is powered by two T55-L-712 or T55-GA-714A engines. The primary mission of the helicopter is troop and cargo transport. The observance of limitations, performance, and weight and balance data provided is mandatory. Your flying experience is recognized, therefore, basic flight principles are not included. It is required that THIS MANUAL BE CARRIED IN THE HELICOPTER AT ALL TIMES.

### 1-3. Introductory Material.

The following paragraphs describe certain sections of this manual, referenced forms, manuals, and Army Regulations. Also included is the procedure to follow to report errors or to recommend changes.

### 1-4. Appendix A, References.

Appendix A is a listing of official publications cited within the manual applicable to and available to flight crews.

### 1-5. Appendix B, Abbreviation.

Appendix B is a list of the abbreviations used in this manual.

### 1-6. Appendix C, Conditional Inspections.

Appendix C is a listing of conditions which require a DA Form 2408-13 entry.

### 1-7. Index.

The index lists in alphabetical order, every titled paragraph, figure, and table contained in this manual.

### 1-8. Army Aviation Safety Program.

Reports necessary to comply with the Army Aviation Safety Program are prescribed in AR 385-40.

### 1-9. Destruction of Army Material to Prevent Enemy Use.

For information concerning destruction of Army material to prevent enemy use, refer to TM 750-2441-5.

### 1-10. Forms and Records.

Army aviators flight record and aircraft maintenance records which are to be used by crewmembers are prescribed in DA PAM 738-751 and TM 55-1500-342-23.

### 1-11. Change Symbol Explanation.

Changes, except as noted below, to the text and tables, including new material on added pages, are indicated by a vertical line. The vertical line is in the outer margin and

extends close to the entire area of the material affected with the following exception: pages with emergency markings, which consist of black diagonal lines around three edges, may have the vertical line or change symbol placed along the inner margins. Symbols show current changes only. A miniature pointing hand symbol is used to denote a change to an illustration. However, a vertical line in the outer margin, rather than miniature pointing hands, is used when there have been extensive changes made to an illustration. Change symbols are not used to indicate changes in the following:

- a. Introductory material.
- b. Indexes and tabular data where the change cannot be identified.
- c. Blank space resulting from the deletion of text, an illustration, or a table.
- d. Correction of minor inaccuracies, such as spelling, punctuation, relocation of material, etc., unless such correction changes the meaning of instructive information and procedures.

### 1-12. Aircraft Designation System.

The designation system prescribed by AR 70-50 is used in aircraft designations as follows:

Example CH-47D

- C - Mission symbol (cargo)
- H - Basic mission and type symbol (Helicopter)
- 47 - Design number
- D - Series symbol

#### 1-12.1. Series and Effectivity Codes.

Designator symbols listed below are used to show limited effectivity of airframe information material in conjunction with text content, paragraph titles, and illustrations. Designators may be used to indicate proper effectivity, unless the material applies to all models and configuration within the manual. Designator symbols precede procedural steps in Chapters 5, 8 and 9. If the material applies to all series and configurations, no designator symbol will be used.

DESIGNATOR SYMBOL	APPLICATION
712	CH-47D aircraft equipped with T55-L-712 engines.
714A	CH-47D aircraft equipped with T55-GA-714A engines.

### 1-13. Use of "Shall, Should, and May".

Within this technical manual, the word "shall" is used to indicate a mandatory requirement. The word "should" is used to indicate a nonmandatory but preferred method of accomplishment. The word "may" is used to indicate an acceptable method of accomplishment.

## CHAPTER 2 AIRCRAFT AND SYSTEMS DESCRIPTION AND OPERATION

### SECTION I HELICOPTER

#### 2-1. General.

The CH-47D (fig. 2-1 through 2-3) is a twin-turbine engine, tandem rotor helicopter designed for transportation of cargo, troops, and weapons during day, night, visual, and instrument conditions. (Unless otherwise noted, numbers refer to fig. 2-1.) The helicopter is powered by two T55-L-712 or T55-GA-714A shaft-turbine engines (18) on the aft fuselage. The engines simultaneously drive two tandem three-bladed counterrotating rotors (13 and 19) through engine transmissions (25), a combining transmission (16), drive shafting (14), and reduction transmissions (12 and 23). The forward transmission is on the forward pylon above the cockpit (1). The aft transmission, the combining transmission, and drive shafting are in the aft cabin section and aft pylon sections (3 and 4). Drive shafting from the combining transmission to the forward transmission is housed in a tunnel along top of the fuselage. When the rotors are stationary, a gas-turbine auxiliary power unit (22) drives a generator and hydraulic pump to furnish hydraulic and electrical power. Fuel is carried in pods on each side of the fuselage. The helicopter is equipped with four non-retractable landing gear. An entrance door (15) is at the forward right side of the cargo compartment (2). At the rear of the cargo compartment is a hydraulically powered loading ramp (26). The pilot's seat (9) and controls are at the right side of the cockpit; the copilot's seat (40) and controls are on the left side. See figure 2-4 for typical cockpit and controls.

#### 2-2. Gross Weight.

The maximum gross weight of the CH-47D is **50,000** pounds. Chapters 5 and 6 provides additional weight information.

#### 2-3. Landing Gear System.

The landing gear system consists of four non-retractable landing gears mounted on the fuselage pods. The forward landing gears are a fixed-cantilever type and have twin wheels. The aft landing gears are of the single-wheel, full-swivel (360°) type which can be power centered and locked in trailed position. In addition, the aft right landing gear can be steered from the cockpit by using the steering control knob on the console. Each landing gear has an individual air-oil shock strut and is equipped with tube-type tires.

#### 2-4. Landing Gear Proximity Switches.

a. Two proximity switches are installed, one on each aft landing gear. Each switch is activated when its associated shock strut is compressed during touchdown. The switches improve ground handling by reducing pitch axis gain of the AFCS, by cancelling the longitudinal control position transducer (CPT), therefore longitudinal stick input, to the differential airspeed hold (DASH) actuators, and by driving both longitudinal cyclic trim (LCT) actuators to the ground position. In addition to the above functions, the switch on the right aft landing gear, when activated, disables the flare dispenser to prevent accidental flare release, lockouts the OMEGA navigation system, and enables the hold function of mode 4 transponder codes.

b. On helicopters equipped with GROUND CONTACT indicating lights, activation of the proximity switches when the associated shock strut is compressed will cause the associated GROUND CONTACT indicating light on the MAINTENANCE PANEL to illuminate.

#### CAUTION

**Should either or both GROUND CONTACT indicating lights remain illuminated after lift-off to hover, the indicated system(s) DASH will not function properly in forward flight. If both GROUND CONTACT indicating lights remain illuminated after lift-off, the AUTO function of both cyclic trim systems will be inoperative and both LCT actuators will remain in the GND position.**

c. Aft landing gear proximity switches are not activated in a water landing. As a result, DASH actuators will respond to longitudinal stick motion, producing an apparent increase in control sensitivity. Cyclic motion of  $\pm 3/4$  inch from neutral, if held, will drive DASH actuators hard-over. If longitudinal cyclic movement is required for taxiing, set the AFCS SYSTEM SEL switch to OFF.

#### 2-5. Steering and Swivel Lock System.

The steering and swivel lock system consists of the power steering control box with the STEERING CONTROL panel on the center console, utility system pressure control module, power steering actuator, power steering module, swivel lock module, and the PWR STEER master caution capsule. The STEERING CONTROL panel consists of a three position SWIVEL switch and a steering control knob. The SWIVEL switch controls operation of power steering and swivel locks.

1. Forward cabin section
2. Cabin fuselage section
3. Aft cabin section
4. Pylon section
5. Pitot tubes
6. Radar warning antenna
7. Transponder antenna
8. Center console
9. Pilot seat
10. Glide slope antenna
11. Spoilers
12. Forward transmission
13. Forward rotor
14. Drive shaft
15. Cabin door
16. Combining transmission
17. Engine and combining transmission oil cooler and duct
18. Engine and screen
19. Aft rotor
20. Aft rotor drive shaft
21. Radar warning antenna
22. Auxiliary power unit
23. Aft transmission
24. Hydraulic power units and tanks
25. Engine transmission
26. Ramp
27. Strakes
28. Jettisonable cabin window (typical 6 places)
29. Aft cargo hook
30. Jettisonable cabin bubble window (typical 2 places)
31. Left aft auxiliary fuel tank
32. Utility hatch. Center cargo hook
33. Left main fuel tank
34. Left electrical compartment
35. Forward cargo hook
36. External power receptacle
37. No. 1 flight control hydraulic system ground test connections
38. Cabin escape hatch
39. Jettisonable door
40. Copilot seat
41. AFCS ports

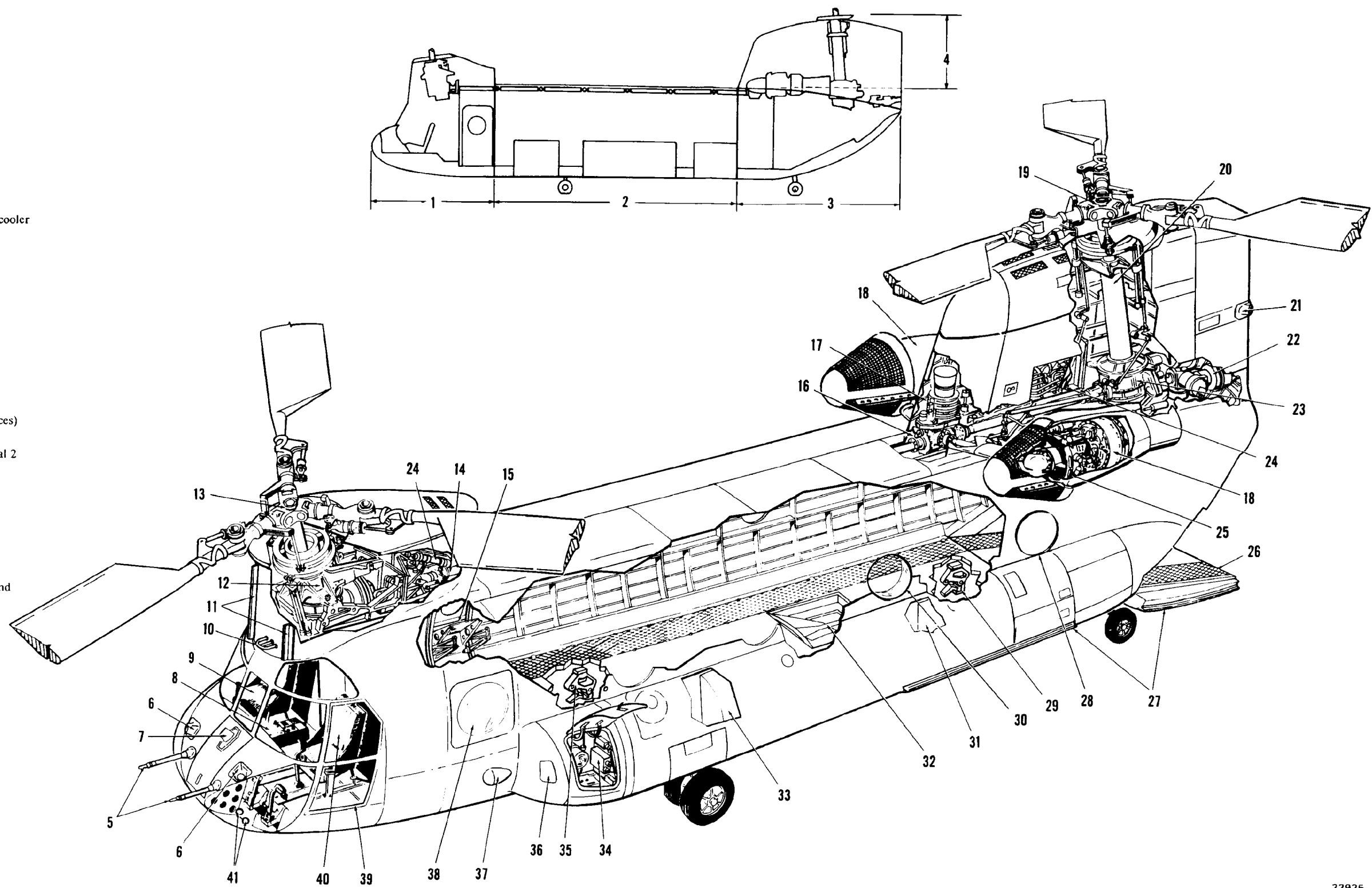
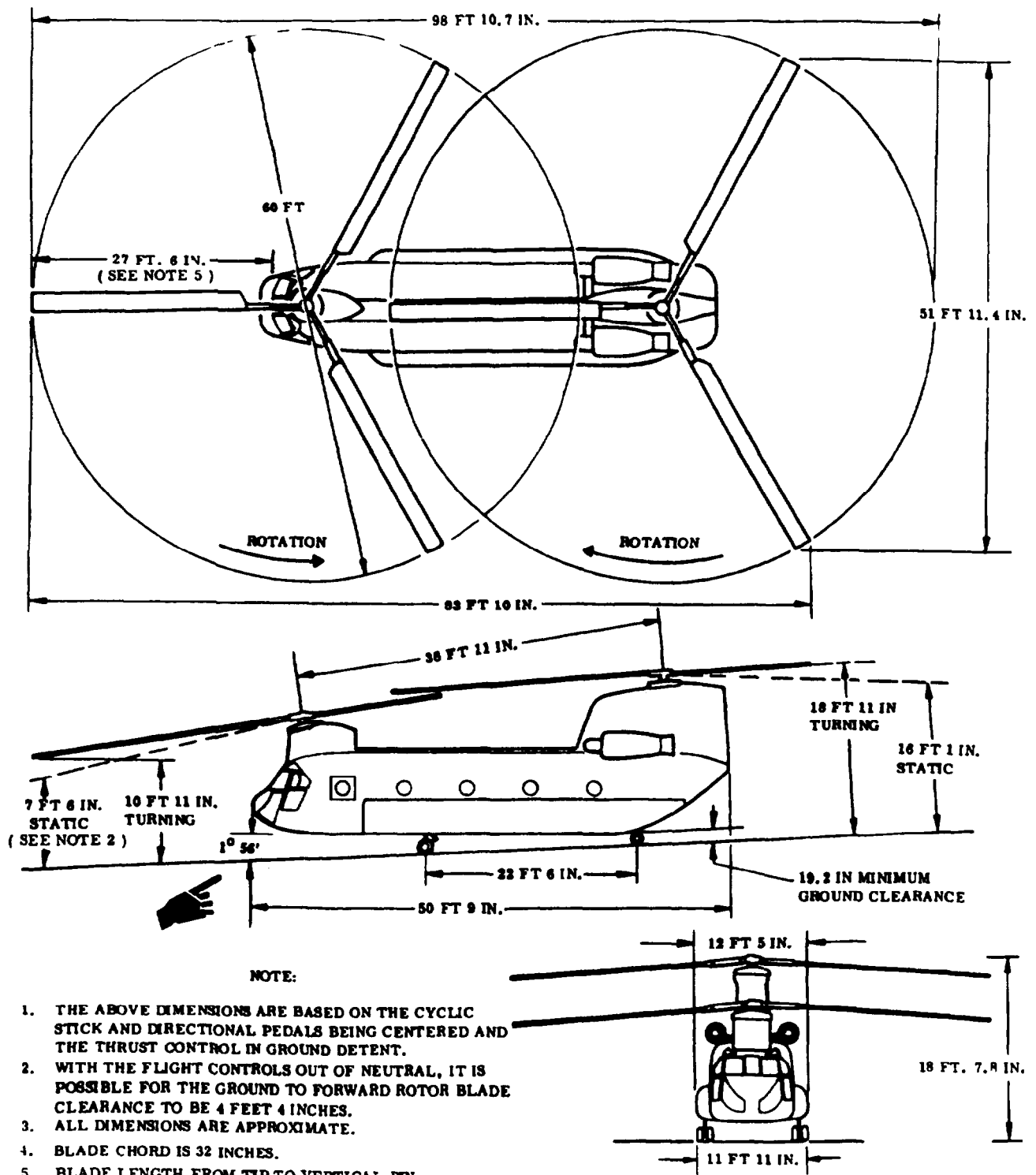
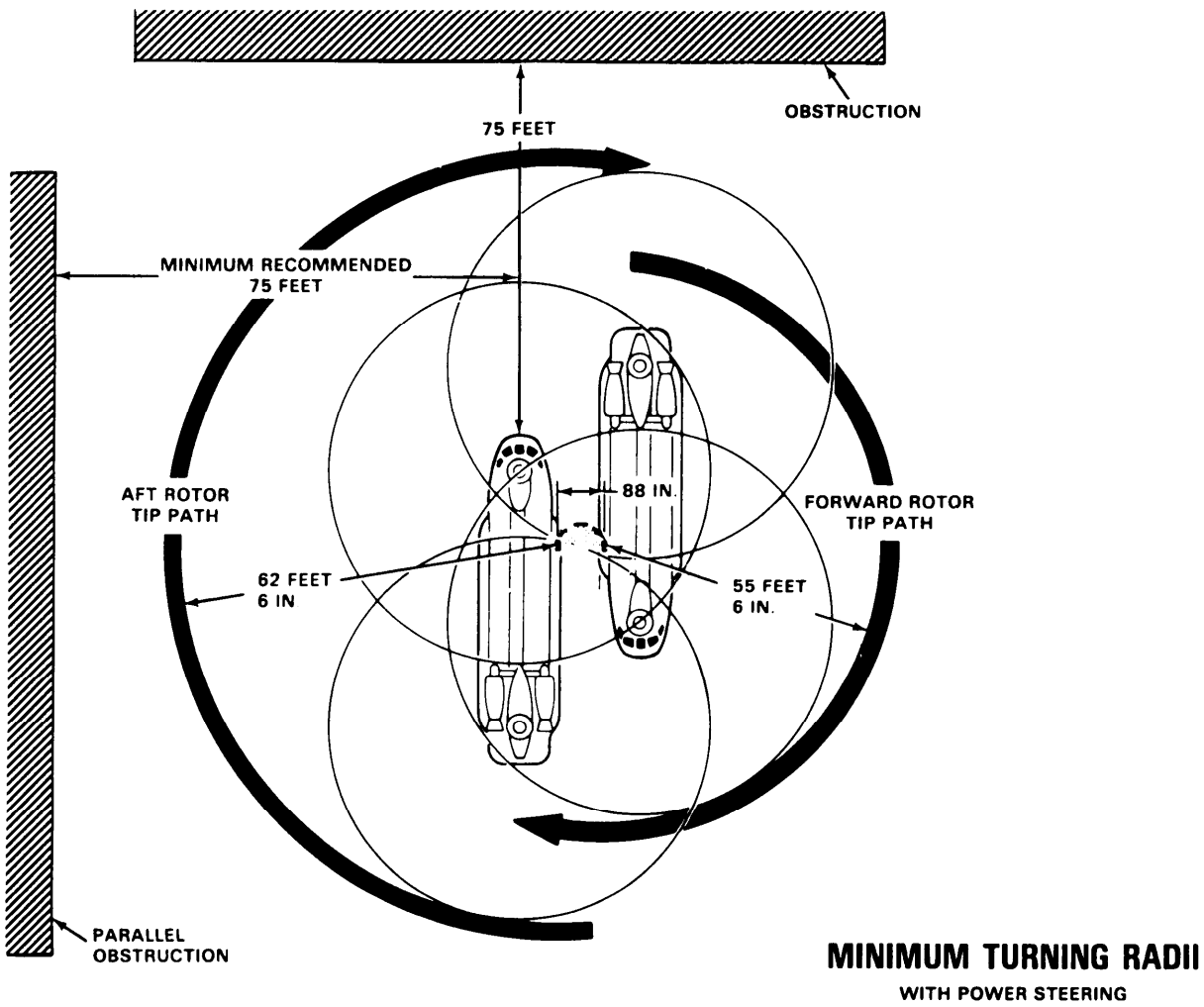


Figure 2-1. General Arrangement



A50279

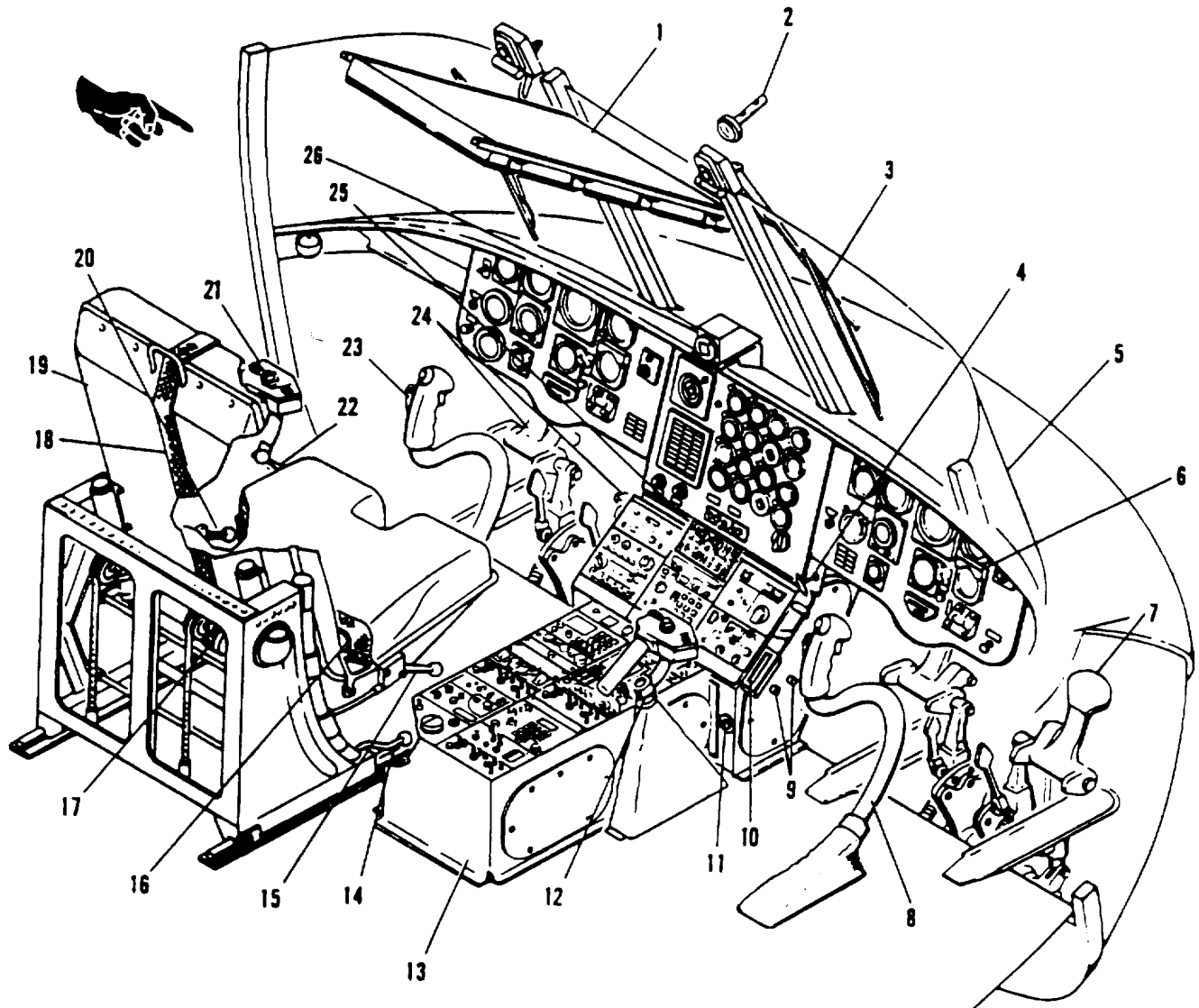
Figure 2-2. Principal Dimensions Diagram



22924

Figure 2-3. Turning Radii





- |  |   |   |
|--|---|---|
| 1. Overhead switch panel                     | 10. Longitudinal stick position indicator | 19. Seat  |
| 2. Free air temperature gauge                | 11. Ignition lock switch                  | 20. Rotational adjustment lever                 |
| 3. Windshield wiper                          | 12. Pilot THRUST CONT (control) lever     | 21. Copilot THRUST CONT (control) lever         |
| 4. Parking brake handle                      | 13. Center console                        | 22. Inertia reel lock                           |
| 5. Windshield                                | 14. Horizontal seat adjustment lever      | 23. Copilot cyclic stick                        |
| 6. Instrument panel                          | 15. Vertical seat adjustment lever        | 24. Copilot wheel brakes and directional pedals |
| 7. Pilot wheel brakes and directional pedals | 16. Safety belt                           | 25. Converter control unit (See note)           |
| 8. Pilot cyclic stick                        | 17. Inertia reel                          | 26. Magnetic compass                            |
| 9. Topping stop studs                        | 18. Shoulder harness                      |   |

**NOTE**

(ON HELICOPTERS MODIFIED BY ANVIS HUD MWO 1-1520-240-50-56)

Figure 2-4. Cockpit and Controls

The switch positions are arranged so the power steering system cannot be energized and used with swivel locks engaged. The aft right landing gear is hydraulically steerable and electrically controlled by the steering control knob.

The PWR STEER caution capsule on the master caution panel indicates that power steering circuits have failed or the aft right wheel has exceeded turning limits. These limits are set at 58° for a left turn and 82° for a right turn. If turning limits are exceeded, an out-of-phase switch on the landing gear automatically closes the power steering solenoid valve, lights the caution capsule, and removes electrical power from the control box. To reenergize the power steering system, the landing gear must be returned within operating limits and the SWIVEL switch must be recycled.

Hydraulic power to operate the power steering actuator and the swivel locks is supplied by the utility hydraulic system through the utility system pressure control module and a separate power steering and swivel lock module. Electrical power to control the steering and swivel locks system is supplied by the No. 1 DC bus through the BRAKE STEER circuit breaker on the No. 1 PDP.

**2-6. STEERING CONTROL Panel.** The STEERING CONTROL panel (fig. 2-5) is on the aft end of the console. It contains the SWIVEL switch, the steering control knob, a fail-safe module and relay, and a servoamplifier. The fail-safe module monitors the steering electrical circuits. A malfunction which could cause a steering hardover will be detected by the fail-safe module and relay which disables the system and turns on the PWR STEER caution light.

a. *SWIVEL switch.* A three-position switch labeled STEER, UNLOCK, and LOCK. Setting the switch to STEER applies DC power to the circuits in the power steering control box and arms the power steering actuator. Rotating the steering control knob will activate the power steering actuator and the aft right wheel will

swivel. Setting the SWIVEL switch to UNLOCK deenergizes the power steering circuits in the control box and the power steering actuator. It maintains the swivel locks in the disengaged position and both aft wheels are free to swivel. Setting the SWIVEL switch to LOCK energizes the swivel lock and centering cam control valve. Utility system pressure is directed to the lock port of the swivel lock cylinder and centering cam. The aft wheels will rotate to neutral trail position and the swivel lock will engage when helicopter weight is lifted from the rear wheels. AFCS heading hold is disabled at STEER and UNLOCK.

b. *Steering control knob.* The steering control knob has index marks around the knob to indicate degrees of knob rotation LEFT and RIGHT in increments of 30°. These index marks do not represent wheel turn angle; they are reference marks only. The knob is spring-loaded to zero turn angle. Power steering is accomplished by rotating the knob a given amount in the desired direction. When the knob is rotated, a servo valve on the power steering actuator regulates hydraulic pressure to extend or retract the actuator. A feedback variable resistor, also on the power steering actuator, stops actuator travel when the selected turn radius is reached.

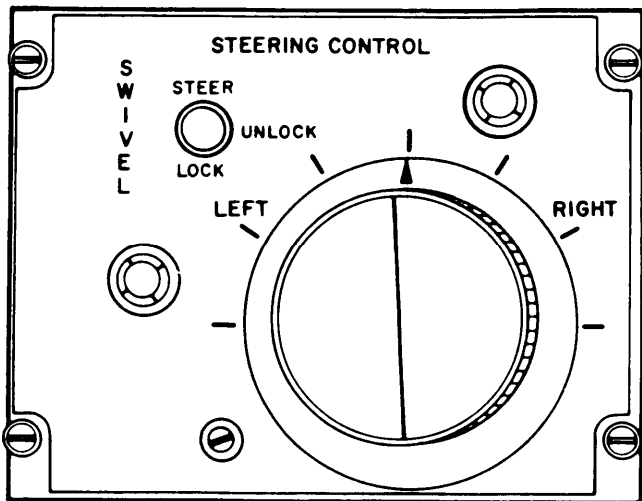
**2-7. Brake System.**

The four wheels of the forward landing gear, and two wheels of the aft landing gear, are equipped with self-adjusting disk brakes. Both forward and aft brakes can be applied and brake pressure maintained by depressing the pedals. Hydraulic pressure is supplied by the utility hydraulic system.

**2-8. Brake Pedals.** When either the pilot's or copilot's brake pedals are pressed, pressure from the master brake cylinders goes to a transfer valve in the brake lines. This allows independent braking by either pilot. From these transfer valves, pressure is directed through a parking brake valve to the forward and aft wheel brakes.

**2-9. Parking Brake Handle.** A parking brake handle (4, fig. 2-4) is at the bottom left corner of the pilot's section of the instrument panel. The brake handle is mechanically connected to the parking brake valve. The parking brake valve is electrically connected to the PARK BRAKE ON caution capsule on the master caution panel. When the brake pedals are pressed and the parking brake handle is pulled OUT, pressure is trapped and maintained on forward and aft wheel brakes. At the same time, electrical power from the DC essential bus through the LIGHTING CAUTION PNL circuit breaker, lights the PARK BRAKE ON caution capsule.

The parking brakes must be released by applying pressure to the brake pedals. This action automatically opens the parking brake valve, retracts the parking brake handle, and extinguishes the PARK BRAKE ON caution capsule.



D145-30-10

Figure 2-5. Steering Control Panel

## 2-10. Brakes and Steering Isolation Switch.

The brakes and steering isolation switch is on the HYD control panel on the overhead switch panel (fig. 2-12). It is labeled BRK STEER, ON, and OFF. The switch isolates the brakes and steering hydraulic subsystems from the rest of the utility hydraulic system in the event of a leak in the subsystem. The normal position of the switch is ON. The switch is guarded to ON. Setting the switch to OFF, closes the power steering and brakes valve on the utility system pressure control module, isolating the brakes and steering subsystem. With the switch at OFF, limited brake applications are available due to an emergency brake accumulator in the brake subsystem. Power to operate the isolation valve is from the No. 1 DC bus through the HYDRAULICS BRAISE STEER circuit breaker on the No. 1 PDP.

## 2-11. Instrument and Control Panels.

### NOTE

The NVG overhead switch panels are shown. Description of control panels and operating procedures reflect NVG configuration only.

Figures 2-6 and 2-7 show center and canted consoles. **712** Figures 2-8 through 2-12 show the copilot instrument panel, center instrument panel, pilot instrument panel, and the NVG overhead switch panel. **714A** Figures 2-12.1 through 2-12.6 show the copilot instrument panel, center instrument panel, pilot instrument panel, and the NVG overhead switch panel.

## 2-12. Personnel/Cargo Doors.

Entry can be made through either the main cabin door or the cargo door and ramp.

## 2-13. Main Cabin Door.

The main cabin entrance (15, fig. 2-1) door is on the right side of the cargo compartment. The door is divided into two sections: the upper section containing a jettisonable panel and the lower section forming the entrance step. When opened, the upper section slides upward on overhead rails and the lower section swings downward. When closed, the two sections mate to form the complete door. Handles are provided on both the outside and inside of the door for accessibility. Refer to Chapter 5 for the allowable airspeed imposed on the helicopter while operating with the cabin entrance door sections in various positions.

## 2-14. Cargo Door and Ramp.

Chapter 6 provides a detail description and operation of the cargo door and ramp.

## 2-15. Pilot and Copilot Sliding Windows.

The upper section of each jettisonable door (39, fig. 2-1) in the cockpit contains a sliding window. The window slides fore and aft and is locked and unlocked by a handle at the forward end of the jettisonable door. The handle is moved forward to lock the window and aft to unlock the window,

## 2-16. Seats.

The pilot's and copilot's seats (9 and 40, fig. 2-1) are on tracks to permit forward-and-aft, vertical, and reclining position adjustments. Bungee cords in each seat exert an upward force on the seat when it is down or tilted.

**2-17. Seat Fore-and-Aft Lever.** A fore-and-aft control lever (14, fig. 2-4) for horizontal seat adjustment is on the right side of each seat support carriage. When the lever is pulled UP, the seat is unlocked and can be moved along the tracks on the cockpit floor. When the lever is released, the seat is locked in position horizontally. The total range of horizontal movement is 4 inches in 1 inch increments.

**2-18. Seat Vertical Lever.** Vertical seat adjustment (15, fig. 2-4) is controlled by a lever on the right side of each seat. When this lever is pulled UP, the seat is unlocked and can be moved vertically along a track through a range of 5 inches. The range is divided into 1/2 inch increments. When the lever is released, the seat is locked in position vertically.

**2-19. Seat Rotation Lever.** A control lever (20, fig. 2-4) for adjusting the seat reclining position is on the left side of each seat. When this lever is pulled UP, the seat is unlocked and can be rotated through a 15° tilt range divided into four equal increments. The seat, in effect, is pivoted up and down around a horizontal axis. When the lever is released, the seat is locked in the selected tilt position.

**2-20. Armored Seats.** Both the pilot and copilot seats are equipped with a combination of fixed and adjustable ceramic armor panels (fig. 2-13). Fixed panels are installed under the back and bottom seat cushions and on the outboard side of each seat. A shoulder panel (if installed) is mounted on the outboard side of each seat. The shoulder panel is hinged from the seat back so it can be moved aside for ease of exit from the helicopter. The panel is secured in its normal position by a latch and an exerciser cord.

## 2-21. Shoulder Harness Inertia Reel Lock Lever.

A two-position shoulder harness inertia reel lock lever is on the left side of each seat (22, fig. 2-4). The lever positions are LOCKED (forward) and UNLOCKED (aft). The lock may be moved freely from one position to the other. When the lock lever is in UNLOCKED position, the reel harness cable is released to allow freedom of movement. However, the reel will automatically lock if a horizontal impact force of 2 to 3 g is encountered. When the reel is locked in this manner, it stays locked until the lock lever is moved forward to LOCKED and then returned to UNLOCKED. When the lever is at LOCKED, the reel is manually locked so the pilot is restrained from bending forward. When a crash landing or ditching is anticipated and time permits, manual locking of the shoulder harness inertia reel provides added safety beyond the automatic feature of the inertia reel. Depending on the pilot's seat adjustment, it may not be possible to reach all switches with the inertia reel locked. Each pilot should check and adjust the shoulder harness in locked position to determine whether all switches can be reached.

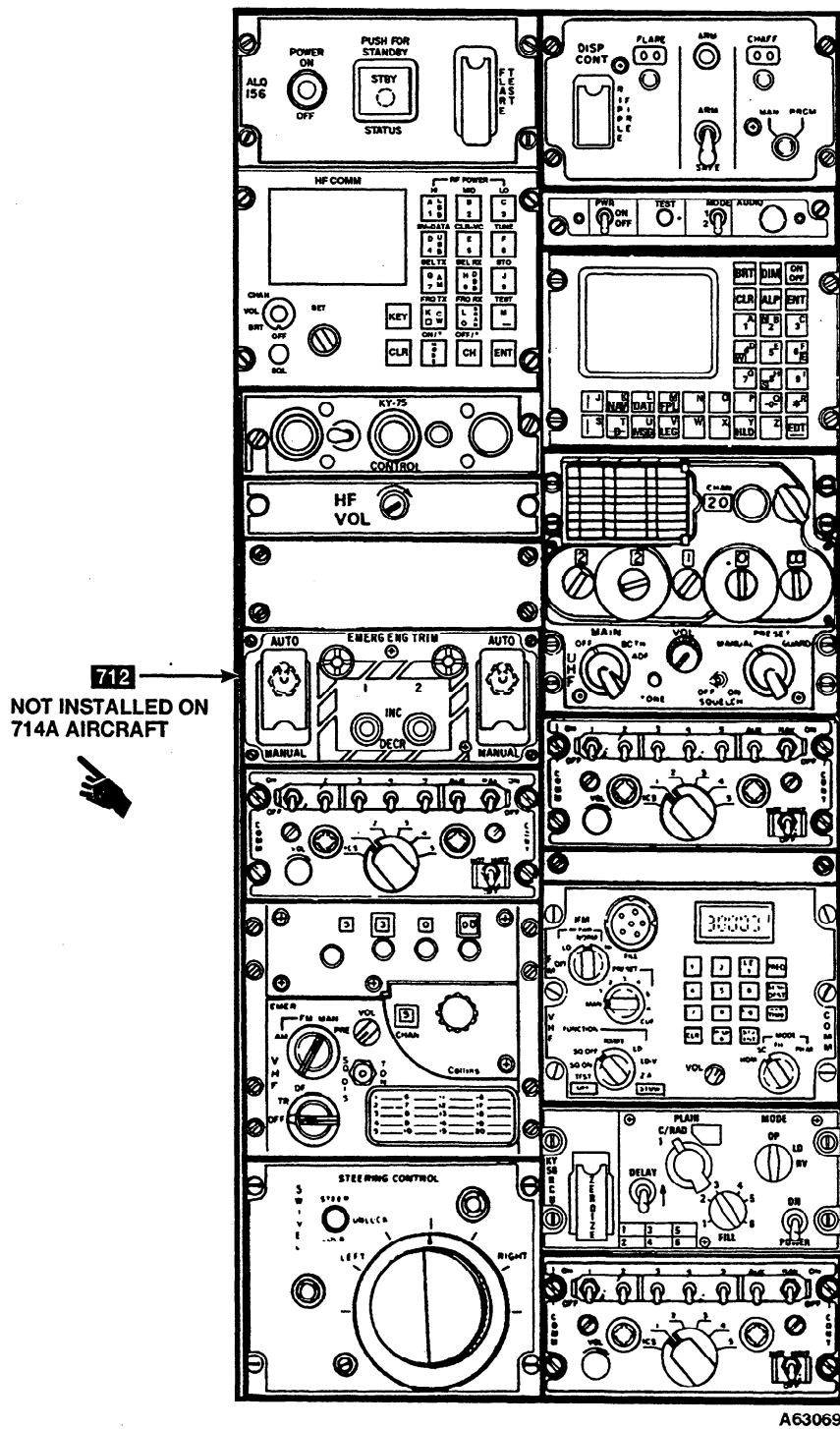


Figure 2-6. Center Console (Typical)

**2-21. Shoulder Harness Inertia Reel Lock Lever.** A two-position shoulder harness inertia reel lock lever is on the left side of each seat (22, fig. 2-4). The lever positions are LOCKED (forward) and UNLOCKED (aft). The lock may be moved freely from one position to the other. When the lock lever is in UNLOCKED position, the reel harness cable is released to allow freedom of movement. However, the reel will automatically lock if a horizontal impact force of 2 to 3 g is encountered. When the reel is locked in this manner, it stays locked until the lock lever is moved forward to LOCKED and then returned to UNLOCKED. When the lever is at LOCKED, the reel is manually locked so the pilot is restrained from bending forward. When a crash landing or ditching is anticipated and time permits, manual locking of the shoulder harness inertia reel provides added safety beyond the automatic feature of the inertia reel.

Depending on the pilot's seat adjustment, it may not be possible to reach all switches with the inertia reel locked. Each pilot should check and adjust the shoulder harness in locked position to determine whether all switches can be reached.

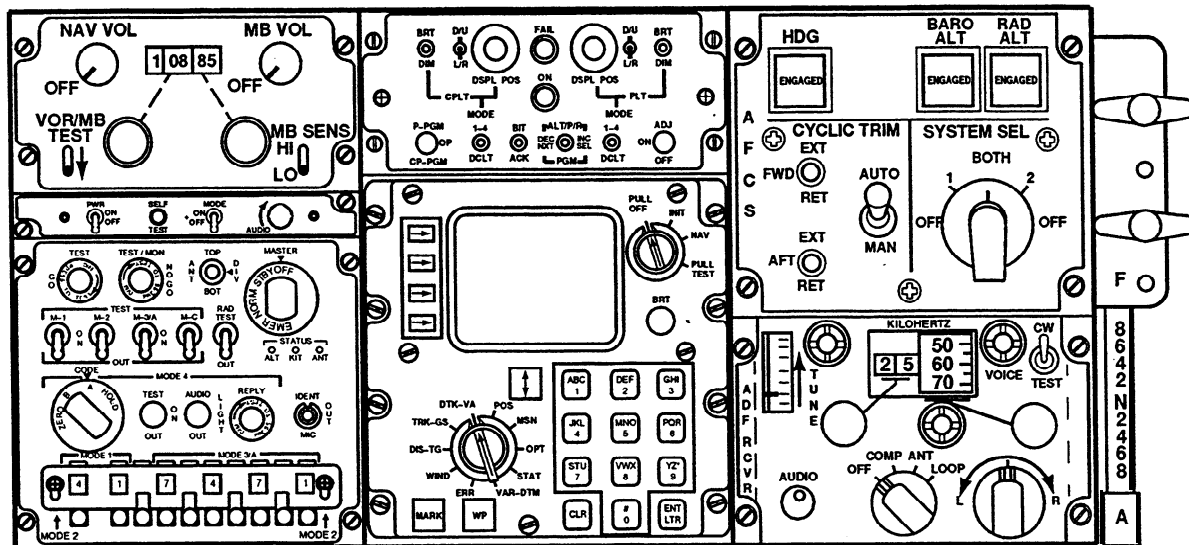
#### **2-22. Self-Tuning Dynamic Absorbers.**

The helicopter is equipped with three self-tuning dynamic absorbers. One absorber is in the nose compartment and the other two absorbers are under each pilot's seat below the cockpit floor. All three absorbers serve to maintain a minimum vibration level through the normal operating rotor RPM range of the helicopter. The self-tuning feature of the dynamic absorber functions as follows: each dynamic absorber consists of a tuning mass

**2-22. Self-Tuning Dynamic Absorbers.**

The helicopter is equipped with three self-tuning dynamic absorbers. One absorber is in the nose compartment and the other two absorbers are under each pilot's seat below the cockpit floor. All three absorbers serve to maintain a minimum vibration level through the normal operating rotor RPM range of the helicopter. The self-tuning feature of the dynamic absorber functions as follows: each dynamic absorber consists of a tuning mass 'suspended by springs, and electronic measuring circuit, accelerometers, counterweights, an electrical actuator and a self-test box. The accelerometers sense and compare the vibration phases of

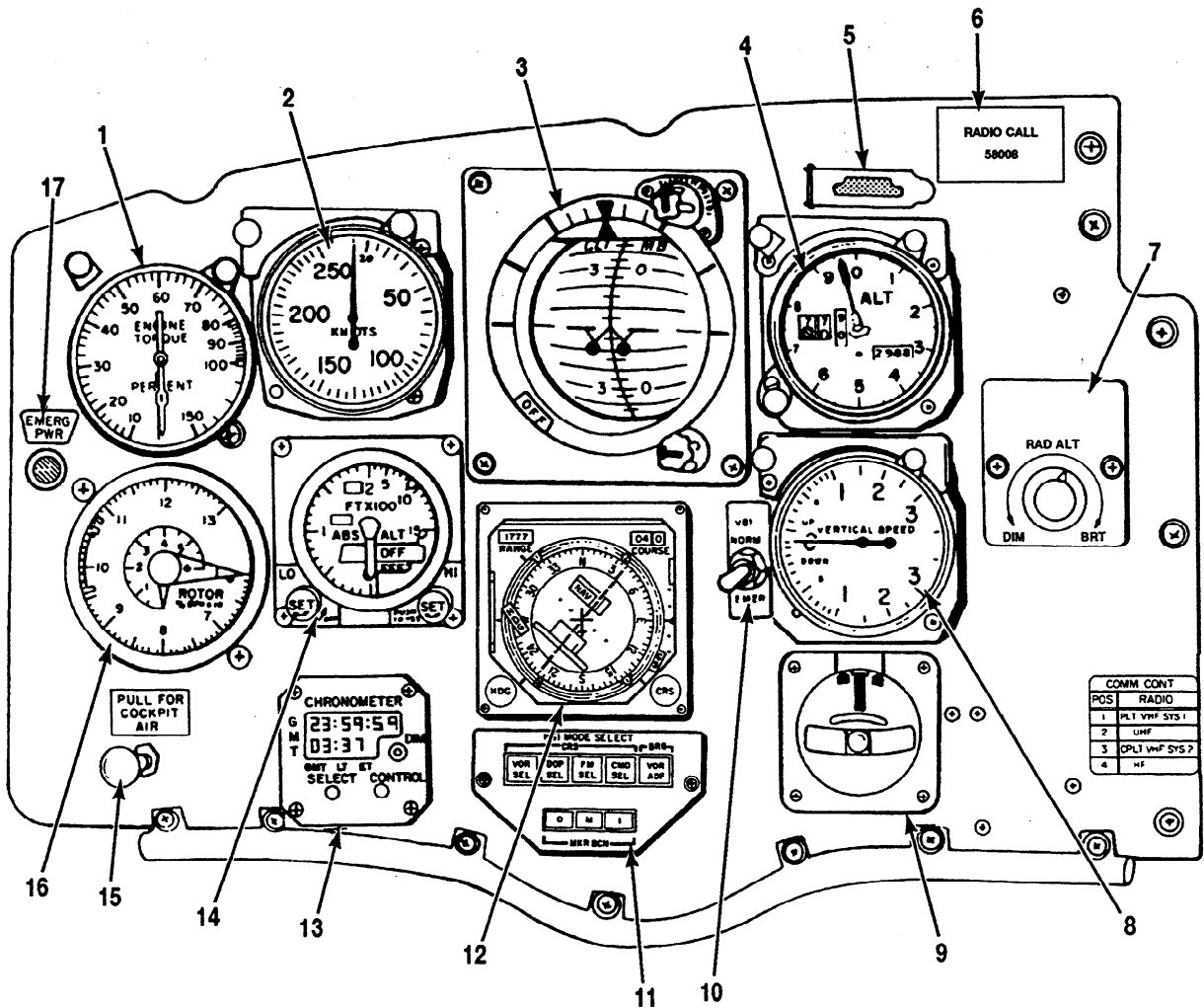
the helicopter and the spring-mounted mass. When the measured vibration phases differ from a built-in phase relationship required to assure proper tune, the electronic circuit extends or retracts the electrical actuator to reposition the counterweights which, in turn, increases or decreases the resonant frequency of the spring-mounted mass. The dynamic absorbers are constantly being adjusted (tuned) to minimize helicopter vibration. A self-test box is in the heater compartment to provide maintenance personnel with an integral testing capability for the self-tuning feature of the dynamic absorbers. Power is supplied by the No. 2 AC bus through the VIB ABSORB-LH, CTR, and RH circuit breakers on the No. 2 PDP.



NOTE:  
 (ON HELICOPTERS MODIFIED BY ANVIS HUD  
 MWO 1-1520-240-50-56)

A64351

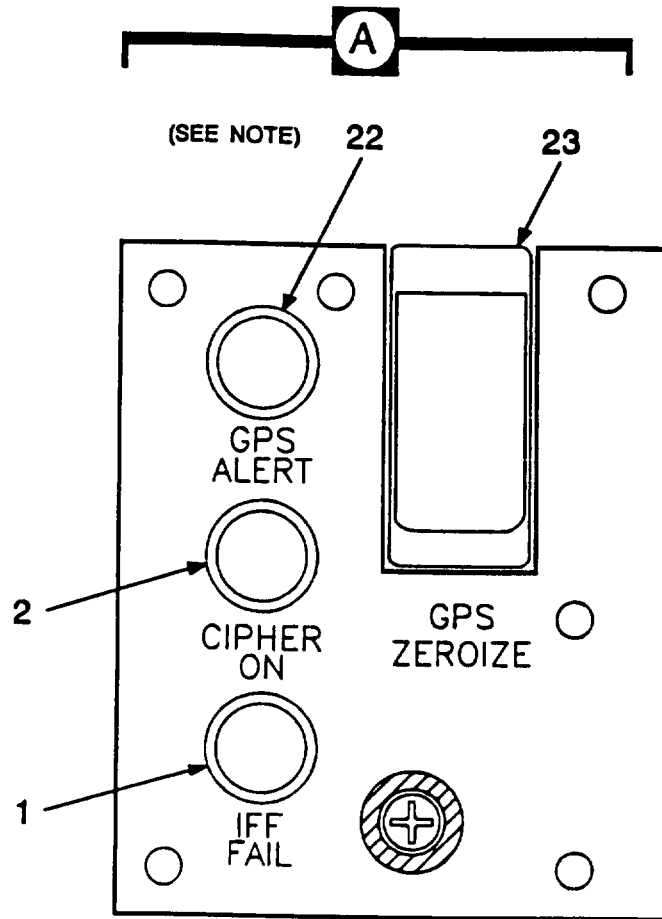
Figure 2-7 Canted Console (Typical)



A9024

- |   |  |
|---|--|
| <ul style="list-style-type: none"> <li>1. Torquemeter</li> <li>2. Airspeed indicator</li> <li>3. Attitude indicator</li> <li>4. Altimeter</li> <li>5. Master caution light with NVG filter</li> <li>6. RADIO CALL plate</li> <li>7. RAD ALT display dimmer switch</li> <li>8. Vertical speed indicator (VSI)</li> <li>9. Turn and slip indicator</li> </ul> | <ul style="list-style-type: none"> <li>10. VGI (vertical gyro indicator) switch</li> <li>11. HSI MODE SELECT panel</li> <li>12. Horizontal situation indicator (HSI)</li> <li>13. CHRONOMETER</li> <li>14. Radar Altimeter</li> <li>15. Cockpit air knob</li> <li>16. Rotor Tachometer</li> <li>17. EMERG PWR (emergency power) indicator light</li> </ul> |
|---|--|

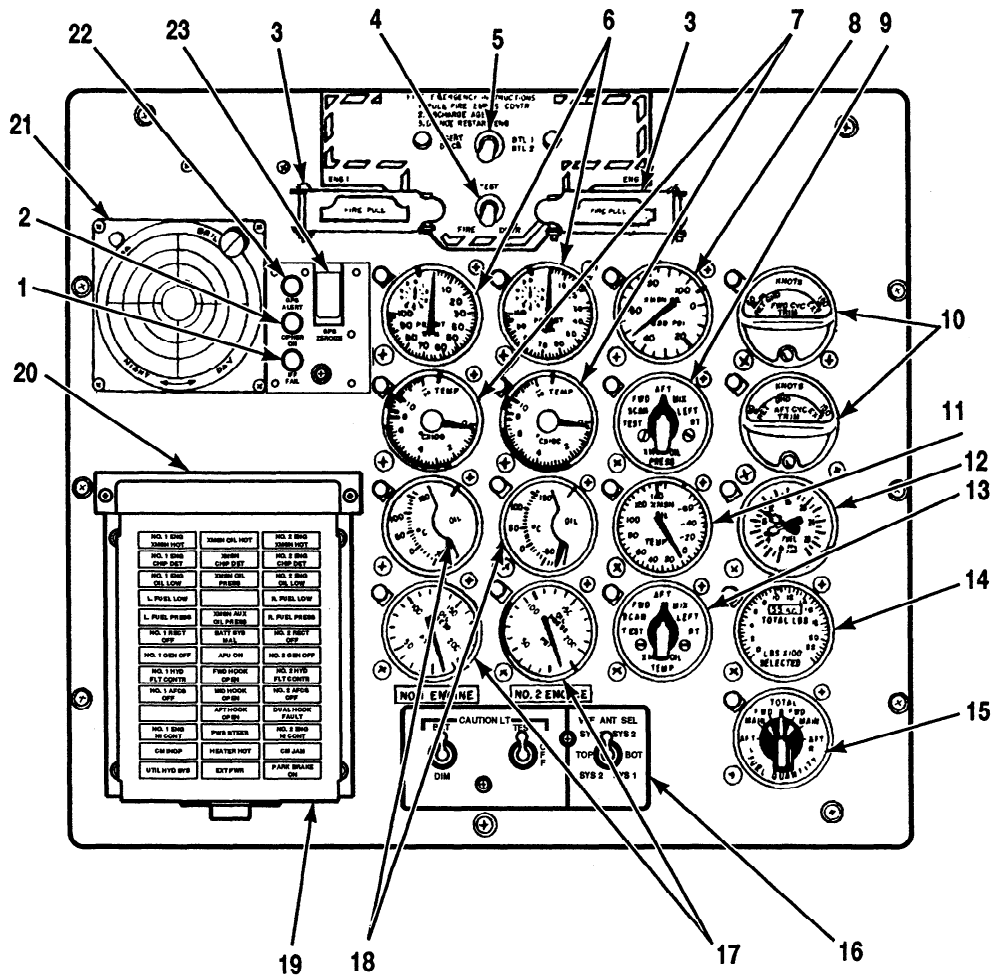
Figure 2-8. Copilot Instrument Panel (Typical) 712



<b>NOTE</b>
AN/ASN-149(V) GPS INSTALLED

Figure 2-9. Center Instrument Panel (Typical)/ (Sheet 2 of 2)

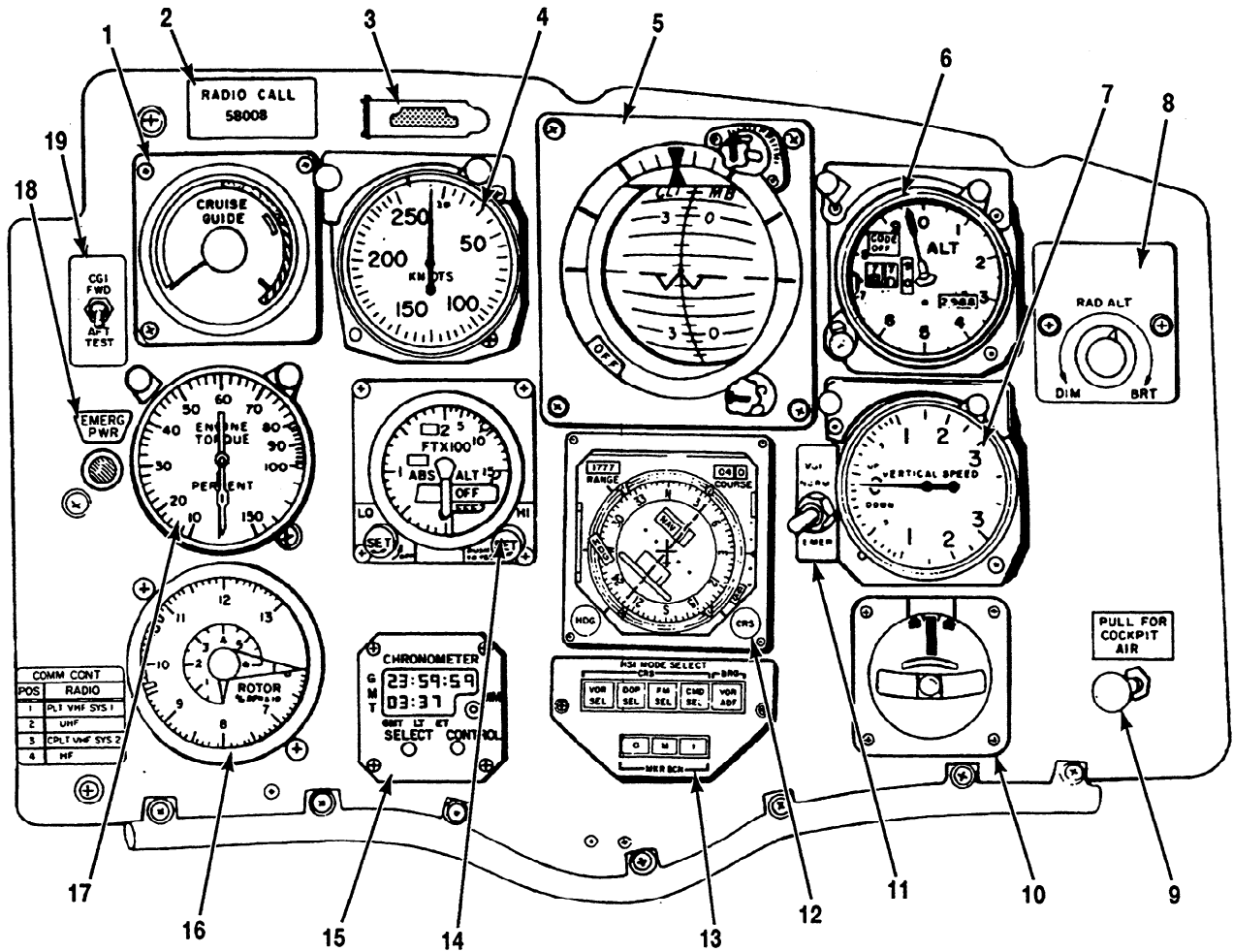




A64346

- |  |   |
|--|---|
| <ul style="list-style-type: none"> <li>1. IFF indicator light</li> <li>2. TSEC KY-58 indicator light</li> <li>3. FIRE PULL handles with NVG filters</li> <li>4. FIRE DETR test switch</li> <li>5. AGENT DISCH switch</li> <li>6. Gas producer tachometer</li> <li>7. Power turbine inlet temperature (PTIT) indicators</li> <li>8. Transmission oil pressure indicator</li> <li>9. XMSN OIL PRESS selector switch</li> <li>10. Longitudinal cyclic trim (LCT) indicators</li> <li>11. Transmission oil temperature indicator</li> <li>12. Fuel flow indicator</li> </ul> | <ul style="list-style-type: none"> <li>13. XMSN OIL TEMP selector switch</li> <li>14. Fuel quantity indicator</li> <li>15. FUEL QUANTITY selector switch</li> <li>16. CAUTION LT and VHF ANT SEL panel</li> <li>17. Engine oil pressure indicators</li> <li>18. Engine oil temperature indicators</li> <li>19. Master caution panel</li> <li>20. Master caution panel NVG filter</li> <li>21. Missile alert display</li> <li>22. GPS ALERT indicator light</li> <li>23. GPS ZEROIZE switch</li> </ul> |
|--|---|

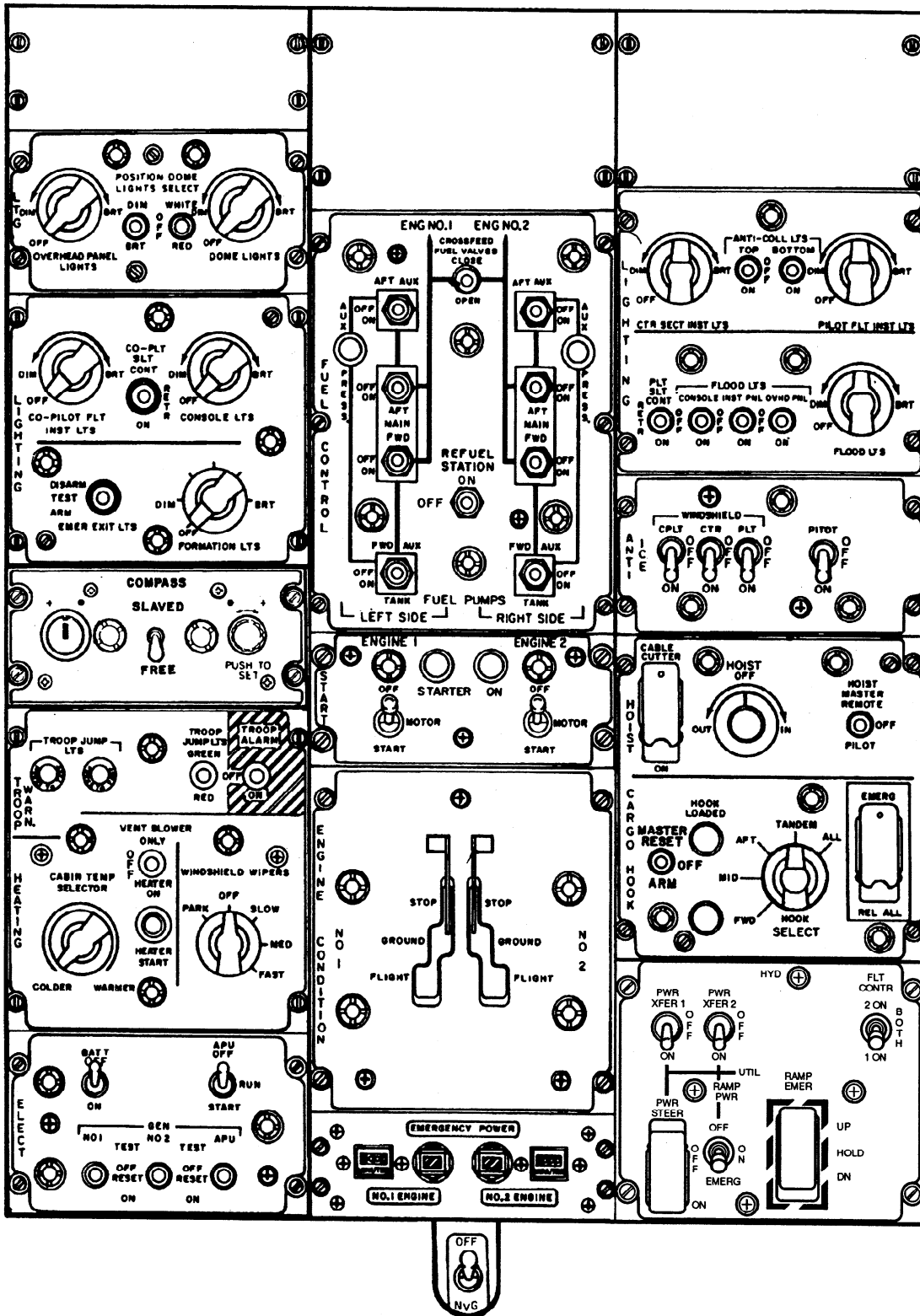
Figure 2-9. Center Instrument Panel (Typical) 712



A9023

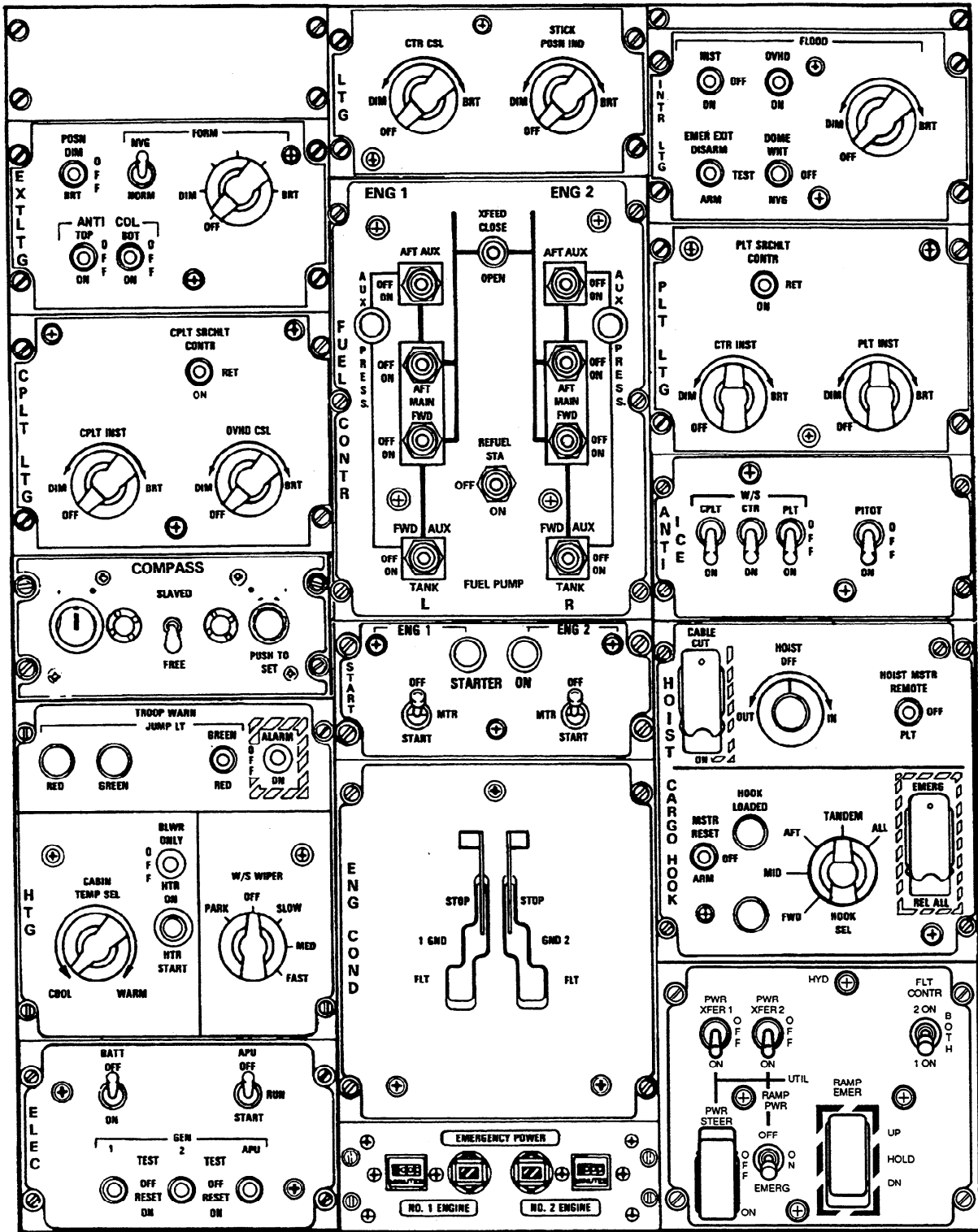
- |   |   |
|---|---|
| <ol style="list-style-type: none"> <li>1. CRUISE GUIDE indicator</li> <li>2. RADIO CALL plate</li> <li>3. Master caution light with NVG filter</li> <li>4. Airspeed indicator</li> <li>5. Attitude indicator</li> <li>6. AIMS altimeter</li> <li>7. Vertical speed indicator (VSI)</li> <li>8. RAD ALT display dimmer switch</li> <li>9. Cockpit air knob</li> <li>10. Turn and slip indicator</li> </ol> | <ol style="list-style-type: none"> <li>11. VGI (vertical gyro indicator) switch</li> <li>12. Horizontal situation indicator (HSI)</li> <li>13. HSI MODE SELECT panel</li> <li>14. Radar altimeter</li> <li>15. CHRONOMETER</li> <li>16. Rotor tachometer</li> <li>17. Torquemeter</li> <li>18. EMERG PWR (emergency power) indicator light</li> <li>19. CGI (cruise guide indicator) test switch</li> </ol> |
|---|---|

Figure 2-10. Pilot Instrument Panel (Typical) **712**



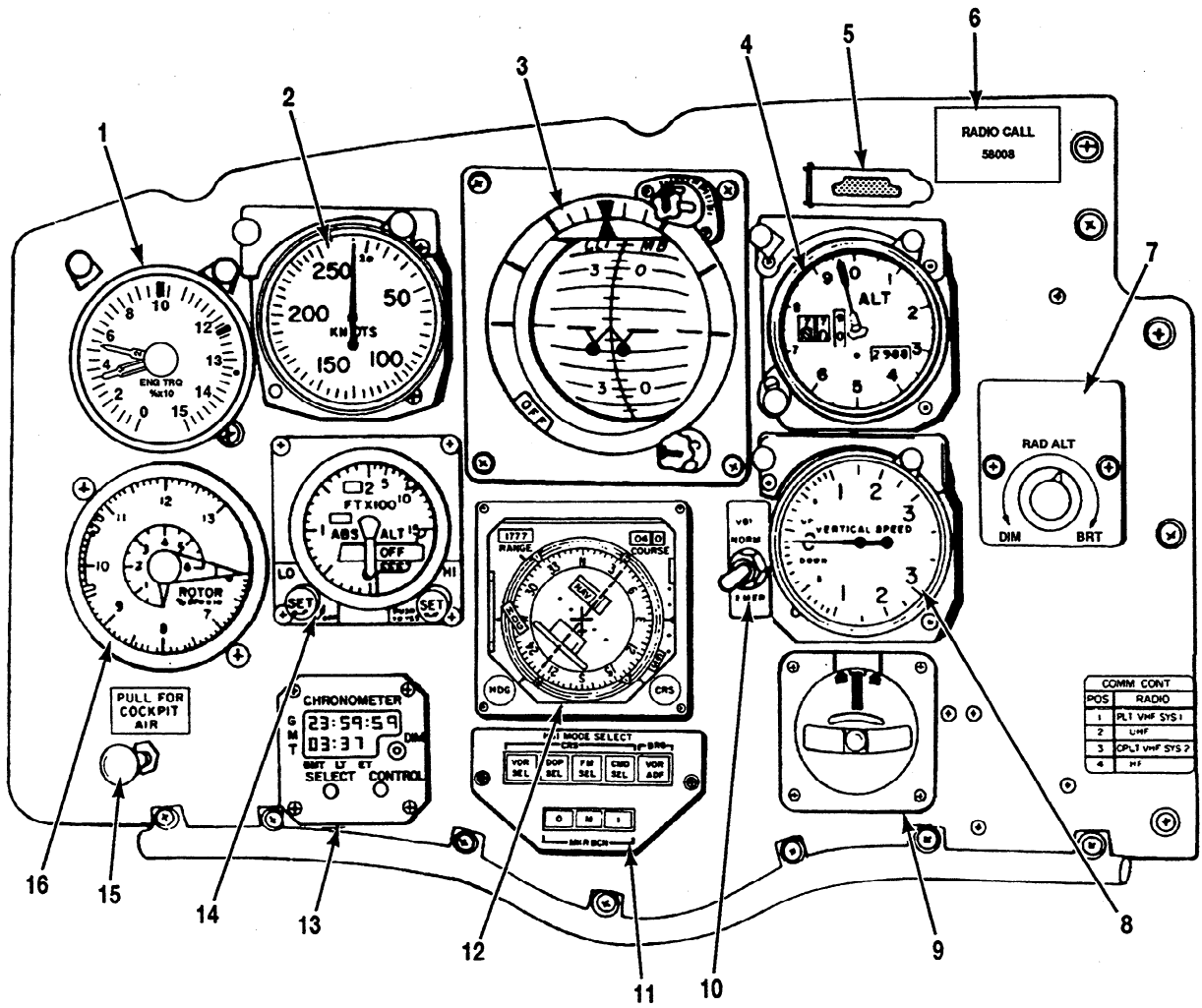
A38955

Figure 2-11. Overhead Switch Panel (Typical) (Interim NVG) **712**



A38953

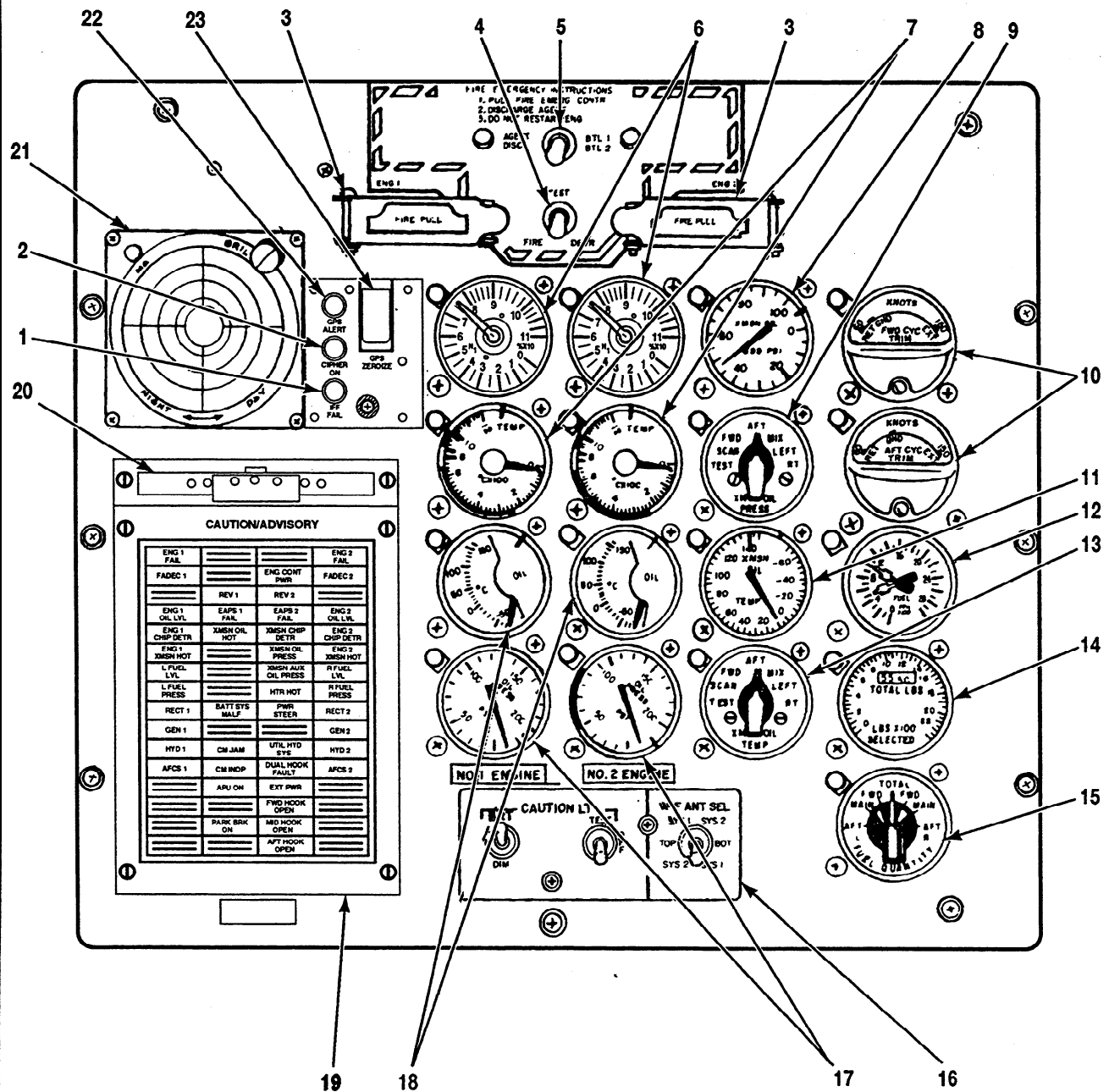
Figure 2-12. Overhead Switch Panel (NVG) 712



A60870

- 1. Torquemeter
- 2. Airspeed indicator
- 3. Attitude indicator
- 4. Altimeter
- 5. Master caution light with NVG filter
- 6. RADIO CALL plate
- 7. RAD ALT display dimmer switch
- 8. Vertical speed indicator (VSI)
- 9. Turn and slip indicator
- 10. VGI (vertical gyro indicator) switch
- 11. HSI MODE SELECT panel
- 12. Horizontal situation indicator
- 13. CHRONOMETER
- 14. Radar altimeter
- 15. Cockpit air knob
- 16. Rotor tachometer

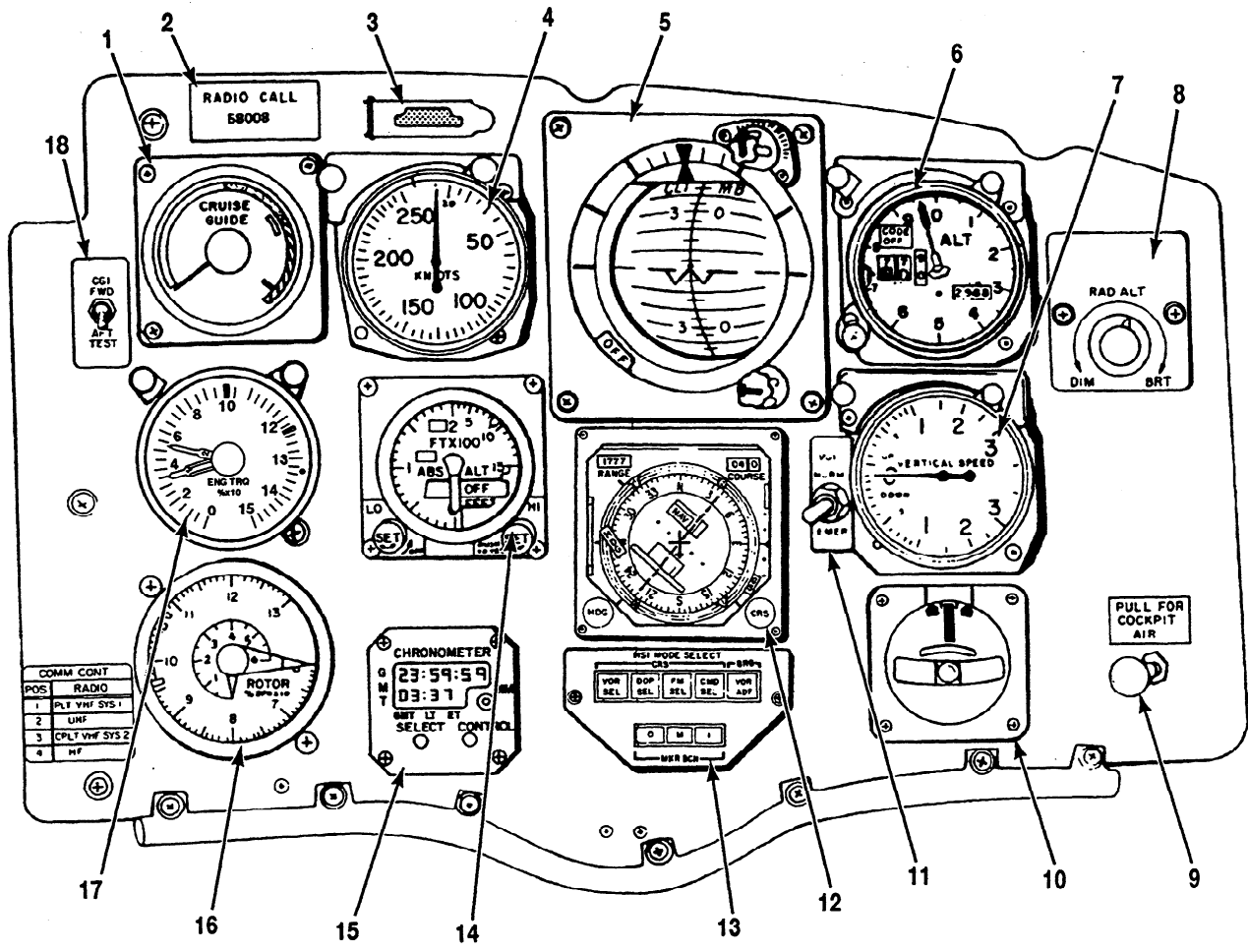
Figure 2-12.1. Copilot Instrument Panel 714A



- |  |  |
|--|--|
| 1. IFF indicator light                               | 13. XMSN OIL TEMP selector switch      |
| 2. TSEC KY-58 indicator light                        | 14. Fuel quantity indicator            |
| 3. FIRE PULL handles with NVG filters                | 15. FUEL QUANTITY selector switch      |
| 4. FIRE DETR test switch                             | 16. CAUTION LT and VHF ANT SEL panel   |
| 5. AGENT DISCH switch                                | 17. Engine oil pressure indicators     |
| 6. Gas producer tachometer                           | 18. Engine oil temperature indicators  |
| 7. Power turbine inlet temperature (PTIT) indicators | 19. CAUTION/ADVISORY panel             |
| 8. Transmission oil pressure indicator               | 20. Master caution advisory NVG filter |
| 9. XMSN OIL PRESS selector switch                    | 21. Missile alert display              |
| 10. Longitudinal cyclic trim (LCT) indicators        | 22. GPS ALERT indicator light          |
| 11. Transmission oil temperature indicator           | 23. GPS ZEROIZE switch                 |
| 12. Fuel flow indicator                              |  |

A64395

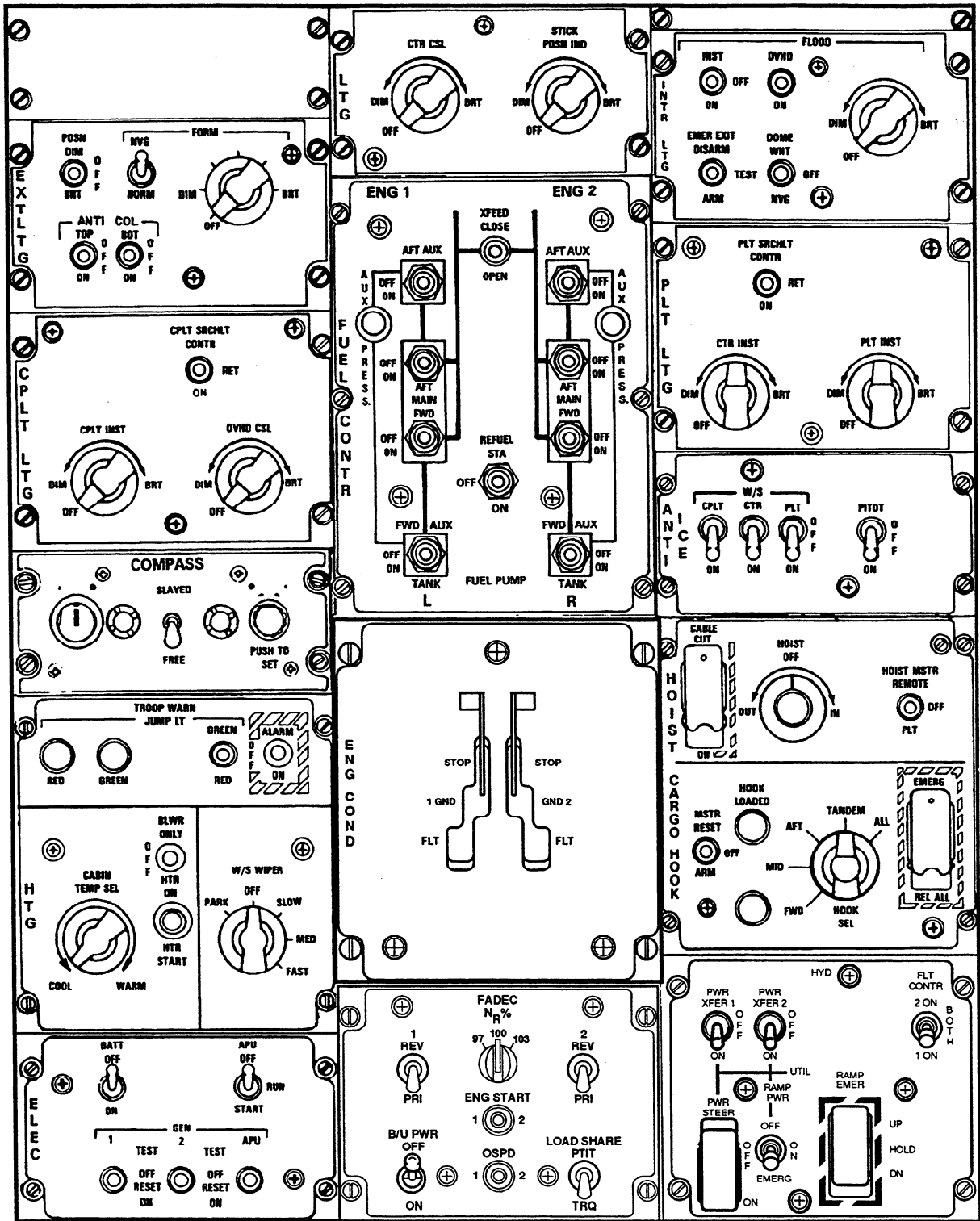
Figure 2-12.2. Center Instrument Panel 714A



A60869

- |   |  |
|---|--|
| <ul style="list-style-type: none"> <li>1. CRUISE GUIDE indicator</li> <li>2. RADIO CALL plate</li> <li>3. Master caution light with NVG filter</li> <li>4. Airspeed indicator</li> <li>5. Attitude indicator</li> <li>6. AIMS altimeter</li> <li>7. Vertical speed indicator (VSI)</li> <li>8. RAD ALT display dimmer switch</li> <li>9. Cockpit air knob</li> <li>10. Turn and slip indicator</li> </ul> | <ul style="list-style-type: none"> <li>11. VGI (vertical gyro indicator) switch</li> <li>12. Horizontal situation indicator (HSI)</li> <li>13. HSI MODE SELECT panel</li> <li>14. Radar altimeter</li> <li>15. CHRONOMETER</li> <li>16. Rotor tachometer</li> <li>17. Torquemeter</li> <li>18. CGI (cruise guide indicator) test switch</li> </ul> |
|---|--|

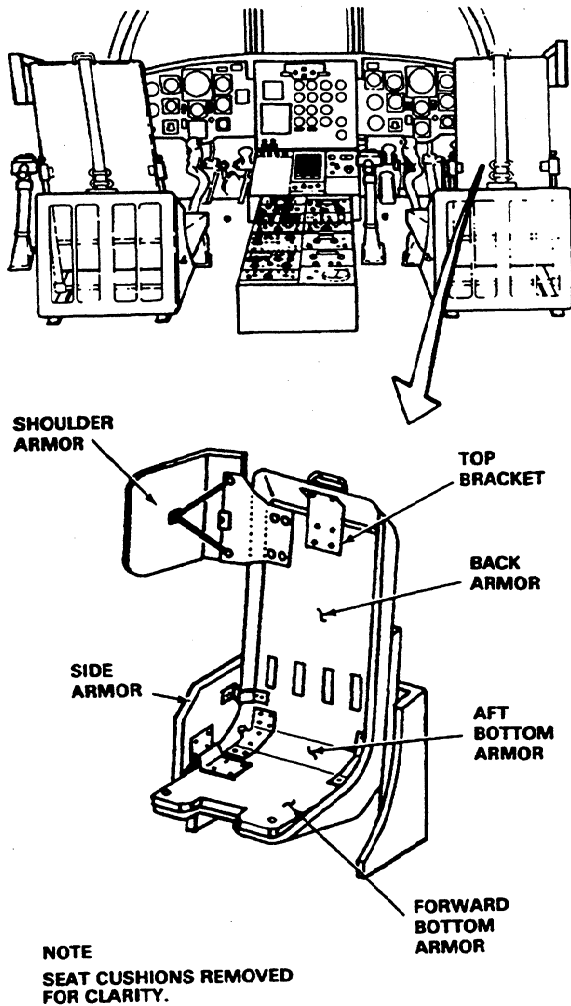
Figure 2-12.3. Pilot Instrument Panel **714A**



A60882

Figure 2-12.4. Overhead Switch Panel 714A





6919

Figure 2-13. Armored Seats

## SECTION II EMERGENCY EQUIPMENT

## 2-23. Emergency Procedures.

Refer to Chapter 9 for all emergency procedures.

## 2-24. Engine Compartment Fire Extinguisher System.

The engine compartment fire extinguisher system (fig. 2-14) enables the pilot or copilot to extinguish a fire in either engine compartment only. It is not designed to extinguish internal engine fires. The system consists of two FIRE PULL handles, an AGENT DISCH (agent discharge) switch, a FIRE DETR (fire detector) switch on the center instrument panel, and two extinguisher agent containers on the overhead structure at stations 482 and 502. The containers are partially filled with monobromotrifluoromethane (CBrF<sub>3</sub> or CF<sub>3</sub>BR) and pressurized with nitrogen (table 2-1 provides the range of engine fire extinguisher pressures.) The agent in one or both of the containers can be discharged into either engine compartment. Selection of the compartment is made by pulling the appropriate FIRE PULL handle. In figure 2-14 the ENG 1 FIRE PULL handle has been pulled. Selection of the container is made by placing the AGENT DISCH switch in the appropriate position. In figure 2-14, BTL 1 has been selected.

## 2-25. FIRE PULL Handles.

**WARNING**

Before flying the aircraft ensure that each FIRE PULL handle NVG filter holder can be rotated from the closed to the open position without causing the FIRE PULL handle to be pulled. Improper handling of the NVG filter holder may cause the FIRE PULL handle to be pulled unintentionally, thus fuel to the affected engine will be shut off and the engine will shut down. Do not use sudden or excessive force when rotating the FIRE PULL handle NVG filter holder from the closed to the open position.

Two control handles for the engine fire extinguisher system (fig. 2-14) are labeled FIRE PULL-FUEL SHUTOFF on the top center section of the center instrument panel. Each handle has a cover for the NVG filter, two warning lights, and the necessary control switches that close the engine fuel shutoff valve and arm the fire extinguisher system circuits. Power is supplied for each FIRE PULL handle from the respective No. 1 and No. 2 DC essential buses through the respective ENGINE NO. 1 and NO. 2 FUEL SHUTOFF circuit breakers on the No. 1 and No. 2 PDP. Power is supplied for each pair of warning lights from the corresponding No. 1 or No. 2 AC bus through the ENGINE NO. 1 and NO. 2 FIRE DET circuit breakers on the No. 1 and No. 2 PDP.

Table 2-1. Engine Compartment Fire Extinguisher Pressures

AMBIENT TEMPERATURE (C)	MINIMUM INDICATION (PSI)	MAXIMUM INDICATION (PSI)
-54°	271	344
-51°	275	350
-40°	292	370
-29°	320	400
-18°	355	437
-7°	396	486
4°	449	540
15°	518	618
27°	593	702
38°	691	784
52°	785	902

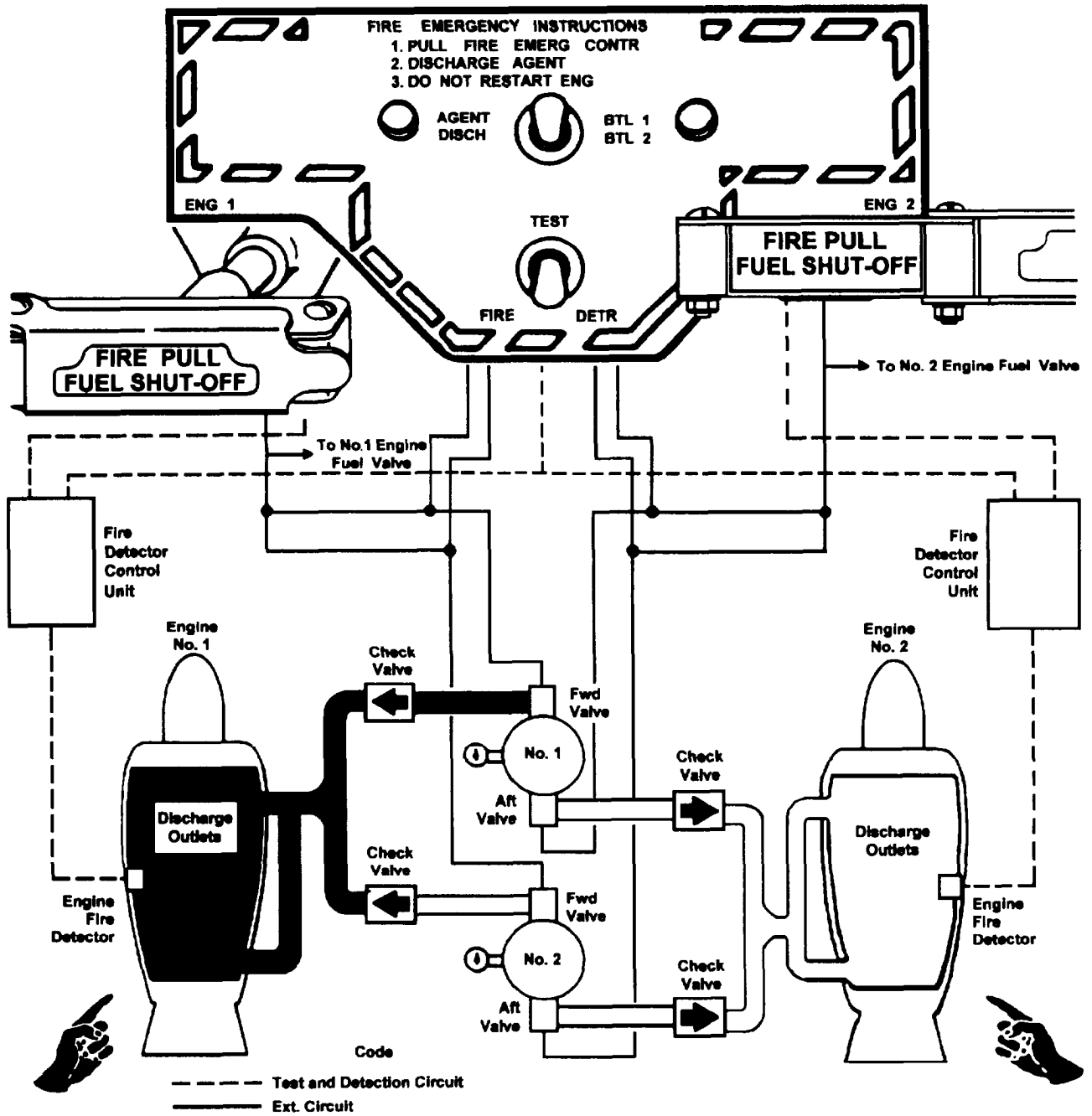


Figure 2-14. Engine Compartment Fire Detect/on and Extinguishing System (Typical)

**WARNING**

If the FIRE PULL handle warning lights are covered by the NVG filters during daylight operation, illumination of the fire warning lights may not be apparent in the event of an engine fire. Do not operate the aircraft with the NVG filters covering or obscuring the fire warning lights unless night vision goggles are being used.

The NVG filter is attached to one end the FIRE PULL handle by a hinged fitting. The other end of the filter holder forms a tab by which the filter holder and filter may be rotated about the hinged fitting. For NVG operations, the filter holder is rotated to a closed position over the front of the FIRE PULL handle cover. In this position, the fire warning light is NVG compatible. For normal operations, the filter holder is rotated from the closed position to the fully open position. In this position, the FIRE PULL handle warning lights will be red.

**CAUTION**

If there is a fire in both engine compartments, do not pull both FIRE PULL handles simultaneously. Extinguish fire in one compartment only as described below. Leave the FIRE PULL handle out after fire has been extinguished. Proceed in a like manner to extinguish fire in the other engine compartment.

When an engine compartment fire occurs on either side, the respective pair of warning lights comes on. The appropriate FIRE PULL handle is pulled, that engine fuel shutoff valve closes and the AGENT DISCH switch is armed.

Selection and discharge of either fire bottle is accomplished by placing the AGENT DISCH switch to BTL 1 or BTL 2. After depletion of the charge in the initially selected bottle, the remaining bottle can be discharged to the same engine compartment by selecting the opposite position on the AGENT DISCH switch. The other FIRE PULL handle performs the same function for its respective engine compartment.

**2-26. AGENT DISCH Switch.**

A three-position AGENT DISCH (discharge) switch is above the FIRE PULL handles on the center instrument panel (fig. 2-14). The lever-lock momentary switch positions are BTL 1, neutral, and BTL 2. When BTL 1 is selected, the agent is discharged from the No. 1 bottle into the selected engine compartment. When BTL 2 is selected, the agent is discharged from the No. 2 bottle into the selected engine compartment. Only two fire extinguisher agent bottles are provided. If the agent from both bottles is used in combating a fire in one engine compartment, agent will not be available should

a fire occur in the other engine compartment. Power is supplied from the corresponding No. 1 or No. 2 DC essential bus through the ENGINE NO. 1 and NO. 2 FIRE EXT circuit breakers on the No. 1 and No. 2 PDP.

**2-27. FIRE DETR Switch.**

A two-position FIRE DETR (detector) switch is below the AGENT DISCH switch on the top center section of the center instrument panel (fig. 2-14). It is labeled FIRE DETR and TEST. The toggle switch is spring-loaded to FIRE DETR which monitors the engine fire detection system. When the switch is placed to TEST, it checks the operation of the engine fire detection system by closing relays in both controls units and the warning lights in both FIRE PULL handles illuminate. Power to operate the test circuit is supplied by the DC essential bus through the LIGHTING CAUTION PNL circuit breaker on the No. 1 PDP.

**2-28. Hand Fire Extinguishers.****WARNING**

Avoid prolonged exposure (5 minutes or more) to high concentrations of fire extinguishing agent and its decomposition products because of irritation to the eyes and nose. Adequate respiratory and eye relief from excessive exposure should be sought as soon as the primary fire emergency permits. Use of oxygen for personnel is recommended.

Three portable 6.3 pound capacity hand fire extinguishers are provided in the helicopter. One is in the cockpit, on the floor to the right of the pilot's seat. Two hand fire extinguishers are in the cabin section. One on the forward bulkhead and one in the left rear, just forward of the ramp.

**2-29. Emergency Troop Alarm and Jump Lights.**

Two emergency troop alarm and jump light boxes are in the cargo compartment. The forward box is on the bulkhead above the avionics equipment shelves and the aft box is on the left side of the fuselage above the ramp at sta. 575. Each box has an electric bell in the center with a red light fixture on one side and a green light fixture on the other side. The TROOP WARN panel on the overhead switch console is used to operate the emergency troop alarm and jump lights.

The emergency troop alarm and jump lights have several functions. They can be used to notify passengers and crew with predetermined signals in time of emergency. The jump lights can be used to notify flight engineer during airborne delivery operations and to alert the troop commander during paratroop drop missions. Refer to Chapter 9 for standard use of the troop alarm.

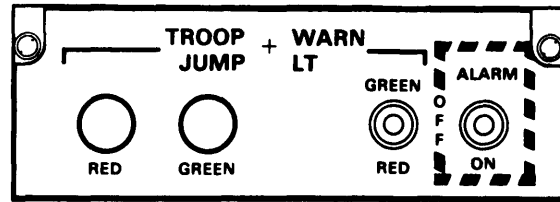
**2-30. TROOP WARN Panel.** The TROOP WARN (warning) panel is located on the overhead switch panel

(fig. 2-15). It has two troop jump lights labeled RED and GREEN. Also, two switches labeled JUMP LT and ALARM. Power to operate and control the emergency troop alarm and jump lights is supplied by the DC essential bus through the TROOP ALARM BELL and TROOP ALARM JUMP LT circuit breakers on the No. 2 PDP.

a. *Troop jump lights.* The troop jump lights provides the pilots a visual indication of the troop jump light selected. One light is provided for each color selected and comes on when the respective light is selected. The brightness of the lights is controlled by the PLT INST rotary control switch on the PLT LTG panel of the overhead switch panel.

b. *JUMP LT switch.* The three-position JUMP LT switch is labeled GREEN, OFF, and RED. When the switch is set to GREEN, the green lights on the emergency troop and jump light box, at both stations, and the troop jump lights on the overhead switch panel come on. When the switch is set to RED, the red lights come on. OFF position turns off both sets of lights.

c. *ALARM switch.* The two-position ALARM switch is labeled OFF and ON. Moving the ALARM switch to ON rings the bell continuously at both stations until the switch is moved to OFF.



A9026

Figure 2-15. Troop Warning Panel (Typical)

**2-31. First Aid Kits.**

Seven aeronautic first aid kits are installed in the helicopter. One kit is in the passageway between the cockpit and cabin. The other six kits are in the cabin fuselage section, three on each side.

**2-32. Emergency Entrances and Exits.**

Refer to Chapter 9 for information on emergency entrances and exits.

**2-33. Emergency Escape Axe.**

An emergency escape axe is provided. It is located on the right side of the cargo compartment slightly forward of station 200.

## SECTION III ENGINES AND RELATED SYSTEMS

### 2-34. Engines.

The CH-47D is powered by either two T55-L-712 or two T55-GA-714A engines. The engines are housed in separate nacelles mounted externally on each side of the aft pylon. The engines have the capability to produce emergency power on pilot demand. See Performance Charts in Chapter 7 **712** or Chapter 7A **714A**.

**2-35. General.** Each engine has a gas producer section and a power turbine section. The gas producer supplies hot gases to drive the power turbine. It also mechanically drives the engine accessory gearbox. The power turbine shaft extends coaxially through the gas producer rotor and rotates independently of it. The gas producer section and the power turbine section are connected by only the hot gases which pass from one section to the other.

During engine starting, air enters the engine inlet and is compressed as it passes through seven axial stages and one centrifugal stage of the compressor rotor. The compressed air passes through a diffuser. Some of the air enters the combustion chamber where it is mixed with start fuel.

The mixture is ignited by four igniter plugs. Some of the air is directed to the fuel nozzles. After the engine is started, it continues to operate on metered fuel supplied to the fuel nozzles.

Hot expanding gases leave the combustion chamber and drive a two-stage gas producer turbine. Energy from the combustion gases also drives the two-stage power turbine, which drives the power turbine shaft to the engine transmission. The engine lubrication system has an integral oil tank which is inside the air inlet housing and is serviced with approximately 12 quarts. (Refer to table 2-3.)

### 2-36. Engine Inlet Screens.

An engine inlet screen which minimizes foreign object damage (FOD) is installed on each engine. The reduction in engine power available with screens installed is negligible. The engine inlet screens have bypass panels. These two panels are on the aft end of each screen. Refer to Chapter 5 for information on use of bypass panels. Helicopters with engine air particle separator (EAPS) installed, refer to TM 55-1520-240-10 EAPS SUPPLEMENT.

### 2-37. Engine Anti-Icing.

The engine air inlet fairing and engine drive shaft fairing receive anti-icing protection from the thermal radiation produced by the oil tank in the engine inlet housing. The hot oil in the oil cavity of the inlet housing warms the air as it passes into the engine inlet.

### 2-38. Engine Power Control System. **712**

Each engine is controlled by a separate power control system which includes cockpit controls and an engine fuel control unit. Each system provides automatic control of engine gas producer rotor speed and power turbine speed in

response to any setting of the engine controls selected by the pilot. Engine gas producer rotor speed (N1) and power turbine speed (N2) are controlled by the fuel control unit, which varies the amount of fuel delivered to the engine fuel nozzles. During normal operation, the fuel control unit automatically controls fuel flow metering during power changes, thus protecting the engine from overspeed and overtemp. Fuel flow is automatically monitored to compensate for changes in outside air temperature and compressor discharge pressure.

### 2-39. Engine Fuel Control Units. **712**

Each engine fuel control unit contains a single element fuel pump, a gas producer speed governor, a power turbine speed governor, an acceleration-deceleration control, a fuel flow limiter, a fuel control fuel shutoff valve, and a main metering valve. A gas producer (N1) lever and a power turbine (N2) lever are mounted on the fuel control unit.

Output power of the power turbine (a function of the speed and torque) is restricted by limiting the maximum fuel flow to the gas producer. Maximum gas producer rotor speed is set by the ENG COND (engine condition) levers in the cockpit. The ENG COND levers electromechanically position the gas producer lever, which controls the fuel control fuel shutoff valve and the operating level of the gas producer. During flight, the ENG COND levers are left at FLT and the output shaft speed is regulated by the power turbine speed (N2) governor.

The power turbine lever is electromechanically positioned by the ENGINE BEEP TRIM switches, thrust control and EMERG ENG TRIM (emergency engine trim) **712** switches. Output shaft torques are limited by the fuel flow limiter, which limits the maximum fuel flow. The position of the main metering valve is determined by the gas producer speed governor, power turbine speed governor, the acceleration-deceleration control, or the fuel flow limiter, depending on engine requirements at that time. The governor or the control unit demanding the least fuel flow overrides the other in regulating the metering valve.

### 2-40. Speed Governing.

The power turbine speed governor senses the speed of the power turbine and regulates the amount of fuel which is supplied to the gas producer. This slows down or speeds up the gas producer rotor so that power turbine and rotor system speed remains nearly constant as loads vary.

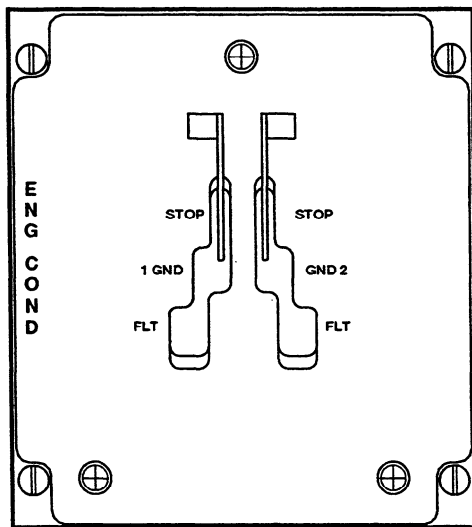
At minimum rotor blade pitch, the amount of power required is at minimum. As pitch is increased, power turbine speed (N2) starts to decrease since more power is required from the engine to maintain a constant rotor speed. The power turbine speed governor senses the decrease of N2 RPM and increases the flow of fuel to the gas producer. Decreasing pitch causes N2 to increase. The power turbine governor senses the increase and reduces the flow of fuel to the gas producer, thus decreasing the engine output power.

The power turbine speed governor allows the power turbine output speed to decrease (droop) approximately 10 percent when the power loading varies from minimum to full load. This is minimized by a droop eliminator linked to the thrust control rod. The droop eliminator automatically changes the power turbine lever to compensate for droop as pitch is increased or decreased. Another type of droop, which is only transient, occurs as a result of the time required for the engine to respond to changing loads due to system lag.

**2-41. ENG COND Levers 712.**

Two ENG COND (engine condition) levers, one for each engine, are on the ENG COND panel (fig. 2-16) of the overhead switch panel. Each lever has three positions labeled STOP, GND, and FLT. They are used to select appropriate fuel flow rates for GND, FLT, and STOP (engine shutdown). Power is supplied by the DC essential buses through the ENGINE NO. 1 and NO. 2 COND CONT circuit breakers on the No. 1 and No. 2 PDP

Each ENG COND lever is spring-loaded outboard and is inhibited by lock gates. They allow the pilot to proportionally control acceleration of the gas producer from STOP to FLT. Two engine control caution capsules are on the master caution panel (fig. 2-51). They are labeled NO. 1 ENG N1 CONT and NO. 2 ENG N1 CONT. The capsules normally illuminate when the ENG COND levers or the N1 actuators are at an intermediate position between STOP, GND, or FLT. They extinguish when the ENG COND lever and N1 actuator positions agree. However, they remain illuminated if a component of the system (actuator, control box, or condition panel) has failed in other than a detent position. Power is supplied by the DC essential bus through the LIGHTING CAUTION PNL circuit breaker on the No. 1 PDP.



91000-A6010

**Figure 2-16. Engine Condition Panel 712**

**CAUTION**

**When the ENG COND lever is placed to GND during start sequence, the N1 actuator could inadvertently go beyond the ground position. The respective ENG N1 COND caution capsule will illuminate. However, ignition will still occur if the start switch is moved to START, thus resulting in a possible engine runaway.**

**CAUTION**

**When adjusting controls or switches on the overhead switch panel, make sure gloves or sleeves do not catch and inadvertently move the ENG COND levers.**

The ENG COND lever must be at GND before the engine will start. When an ENG COND lever is advanced from STOP to GND, power is then supplied to the electromechanical actuator which establishes an appropriate fuel flow rate at ground idle. The speed of the gas producer with the lever at GND should be 60 to 63 percent N1. When an ENG COND lever is moved to FLT, the engine is operating within the N2 governing range, unless the engine is "topped out" at which time it goes back to N1 governing. The N2 governor then takes control to maintain selected rotor RPM (RRPM) in response to the engine beep trim switches and collective pitch changes. When an ENG COND lever is moved to STOP, the gas producer lever closes the fuel control fuel shutoff valve which stops fuel flow to the gas producer.

Each electrical system is completely separate and a failure in one system will not affect the other. A built-in mechanical brake holds the actuator at its last selected position if loss of electrical power occurs. ENG COND lever friction is provided to reduce the possibility of overtorquing the engine transmissions by resisting movement of the ENG COND levers. The ENG COND lever friction brake cannot be adjusted by the pilot and a force of 4 to 5 pounds is needed to move them.

**2-42. Normal Engine Beep Trim Switches.**

**712** On 712 engine installations engine beep trim switches are active at all times during normal operation.

Two momentary switches are on the auxiliary switch bracket of each THRUST CONT lever and are labeled ENGINE BEEP TRIM (fig. 2-26). Both switches have an RPM INCREASE, RPM DECREASE, and a neutral position. **712** One switch is labeled NO. 1 & 2 which is normally used to select desired RRPM. The second switch is labeled NO. 1 which will only affect the No. 1 engine and is used to match engine loads which are indicated by the dual torquemeters.

**712** Power to operate the beep trim system is supplied by the DC and AC buses. DC power to operate a trim motor in

the No. 1 or No. 2 AC buses through the ENGINE NO. 1 or NO. 2 TRIM & TIMER circuit breakers on the No. 1 or No. 2 PDP to be transformed and rectified to DC voltage. This DC power operates the power turbine actuator on the engine fuel control.

**NOTE**

No two engines provide matched performance with regard to torque, RPM, PTIT, or fuel flow. With torque matched, all other parameters may not be matched.





the power turbine control box, which unbalances a control circuit, is supplied by the corresponding No. 1 or No. 2 DC buses through the ENGINE NO. 1 or NO. 2 TRIM circuit breakers on the No. 1 or No. 2 PDP. The unbalanced control circuit causes the AC power from the No. 1 or No. 2 AC buses through the ENGINE NO. 1 or NO. 2 TRIM & TIMER circuit breakers on the No. 1 or No. 2 PDP to be transformed and rectified to DC voltage. This DC power operates the power turbine actuator on the engine fuel control.

#### NOTE

No two engines provide matched performance with regard to torque, RPM, PTIT, or fuel flow. With torque matched all other parameters may not be matched.

**712** Holding the NO. 1 & 2 switch forward (RPM INCREASE) will increase the RRPM. Holding the switch aft (RPM DECREASE) will decrease the RRPM. When the switch is released, it returns to the center or neutral position. The switch electrically controls both power turbines by movement of the N2 actuator through each engine power turbine control box.

The procedure for matching engine load requires that NO. 1 & 2 engine beep switch be used in conjunction with NO. 1 engine beep switch. When NO. 1 engine beep switch is moved forward (RPM INCREASE), the torque of No. 1 engine increases. At the same time RRPM increases, even though No. 2 engine torque decreases slightly. Moving NO. 1 & 2 engine beep trim switch aft (RPM DECREASE) causes both engine torques to decrease and reduce RRPM. If torques are still not matched, this procedure is continued until torques are matched and desired RRPM is attained. The opposite action occurs when NO. 1 engine beep switch is moved aft.

The engine beep trim switches should not be used during power changes initiated by thrust lever movement because RRPM droop should only be momentary. The engine beep trim system adjusts engine RPM only if the respective ENG COND lever is at FLT. At, STOP or GND, it is possible to move the power turbine lever by moving the engine beep trim switches to RPM DECREASE or RPM INCREASE, but in either case, engine RPM will not be affected because the engine is not operating in the N2 governing range.

#### 2-43. EMERG ENG TRIM Panel **712**

The EMERG ENG TRIM (emergency engine) panel is located on the center console (fig. 2-17). The panel consists of two guarded normal engine trim system disable switches and two momentary emergency engine trim switches.

a. *Normal Engine Trim System Disable Switches.* The guarded switches permit the pilot to disable either or both normal beep trim systems. This prevents unwanted signals from the normal beep trim system to interfere with the operation of the emergency engine trim system. Each switch is labeled AUTO and MANUAL. When either switch is at MANUAL, the respective normal beep trim system is disabled (115-volt AC from the AC bus to the engine power turbine control box is interrupted). When the switch is at

AUTO (cover down), the normal beep trim system is functional (115-volt AC from the AC bus is reconnected to the associated engine power turbine control box). Refer to Chapter 9 for emergency engine trim operation.

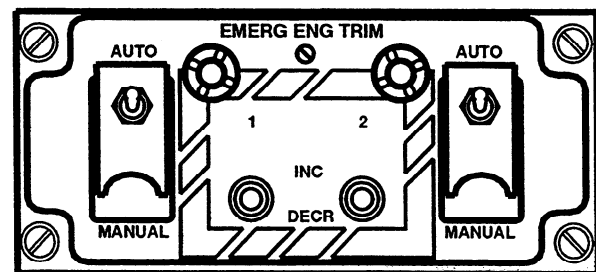
#### CAUTION

**Engine response is much faster when RRPM is controlled with emergency engine beep trim system. It is possible to beep the rotor speed below safe operating speed and low enough to disconnect the generators from the buses. The generators are disconnected at 85% to 82% RRPM after a 3 to 7 second time delay.**

b. *Emergency Engine Trim Switches.* Each momentary switch is used to change the power turbine speed of its respective engine if the power turbine control box (normal beep trim system) malfunctions.

When the normal trim system fails, the droop eliminator also fails to function. Both switches have an INC, DECR, and a spring-loaded center position. When one of the switches is held at INC, power from the essential DC bus goes directly to the respective power turbine actuator and increases the lever setting and the power turbine speed. When the switch is held at DECR, the lever setting is decreased, and the power turbine speed is decreased.

The emergency engine trim switches are to be used when the normal beep trim system is disabled. If one of the switches is used while the respective power turbine control box is functioning normally, the power turbine actuator setting will temporarily change but will return to its original setting when the switch is released. Power to operate the emergency engine beep trim switches and actuators is supplied by the essential DC bus through the NO. 1 and NO. 2 EMERG ENG TRIM circuit breakers on the No. 1 and No. 2 PDP.



A61206

Figure 2-17. Emergency Engine Trim Panel **712**

**2-44. Emergency Power System. 712**

**CAUTION**

To prevent damage, monitor the torque and the PTIT indicators when operating with emergency power. Failure to observe these indicators could result in serious damage to the drive train and engines.

An emergency power system is included with T55-L-712 engines. With the emergency power system, increased power is available on pilot demand and is actuated by raising the thrust control into the emergency power range. Refer to Chapter 5 for limitations on its use.

When fuel flow increases to the point where PTIT is 890° to 910°C, the EMERG PWR lights will illuminate on the copilot and pilot instrument console (17, fig. 2-8 and 18, fig 2-10) If temperature is maintained in this range for more than 5 seconds, the associated indicator will apply 28-volt DC from the ENGINE NO. 1 and /or NO. 2 START & TEMP circuit breaker to the EMERGENCY POWER panel. With 28-volt DC applied to the panel, the applicable emergency power timer will start, and the indicator will display a black-and-white flag. When thrust is reduced below the emergency power level, the emergency power light will extinguish and the timer will stop. However, the emergency power indicator will continue to display the black-and-white flag. The flag can be reset on the ground only.

**WARNING**

Before flight, be sure the two topping stops are in their stowed position on the right side of the console. If the stops are not stowed, be sure the stops are not installed on the fuel controls before you start the engine. Failure to check may result in inability to achieve emergency power in an emergency.

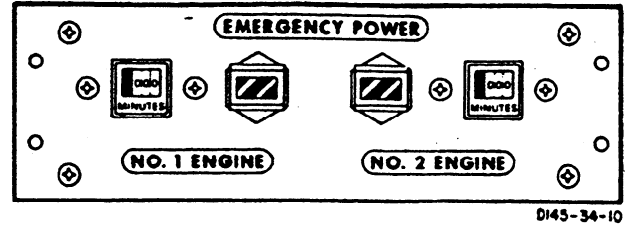
Topping stops are stowed on each helicopter. The stops are installed on the N1 control of each engine for maintenance engine topping checks. The stops provide an established fuel flow when topping. When not in use, the stops are stowed on the right side of the center console aft of the pedals.

**2-45. EMERGENCY POWER Panel. 712**

The EMERGENCY POWER panel is located on the overhead switch panel (fig. 2-18). It consists of an emergency power indicator and a digital timer for each engine. They are labeled NO. 1 and NO. 2 ENGINE. The timer counts the minutes that emergency power is in use.

**2-46. Oil Supply System.**

The oil supply system is an integral part of the engine. The oil tank is part of the air inlet housing and the filler neck is on the top of the housing. An oil level indicator is on the left side of the engine inlet housing. Refer to table 2-3 for the



*Figure 2-18. Emergency Power Panel 712*

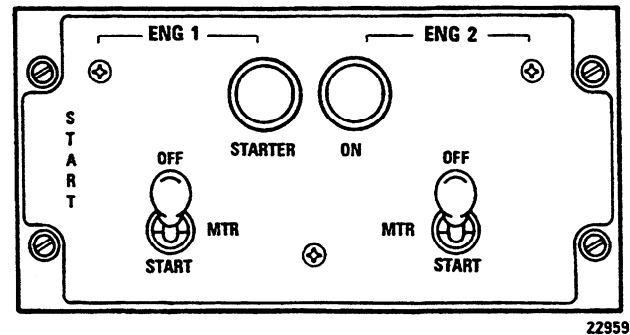
tank capacity. If the oil level decreases to about 2 quarts usable, the corresponding ENG OIL LOW caution capsule will illuminate.

**2-47. Engine Start System. 712**

The engine start system includes the hydraulic starters on each engine, the engine start valves and the solenoid-operated pilot valves on the utility system pressure control modules, the START switch, and the start fuel solenoids and ignition exciters on the engines.

When the start switch is moved to MTR, the respective engine STARTER ON indicator light illuminates and the start valve opens (fig. 2-19). The start valve applies utility system pressure from the APU to the engine starter; rotating the engine starter and compressor. At 15 percent N1, the ENG COND lever is moved to GND. The start switch is immediately moved to START, energizing the ignition exciter. Start fuel is sprayed into the combustor and combustion begins. Before PTIT reaches 200°C, the START switch is manually released to MTR. At MTR, the start fuel valve is closed and the ignition exciter is deenergized.

The engine then accelerates to ground idle speed. At 50 percent N1, the START switch is manually moved to the locked OFF position. At OFF, the pilot valve closes, closing the start valve and deenergizing the STARTER ON indicator light. A relay in each engine start circuit is energized when either START switch is at MTR or START. The relay, when energized, disables the start circuit of the opposite engine, thus preventing simultaneous dual engine starts. Power is supplied by the No. 1 and No. 2 DC essential buses through the ENGINE NO. 1 and NO. 2 START & TEMP and IGN circuit breakers on the No. 1 and No. 2 PDP.



*Figure 2-19. Engine Start Panel 712*

**2-48. START Panel.** 712 The START panel is located on the overhead switch panel (fig. 2-19). It consists of the ENG 1 and ENG 2 STARTER ON indicator lights and two start switches.

a. *Start Switches.* The switches are labeled OFF, MTR, and START. They are locked in OFF, detented in MTR and spring-loaded from START to MTR. At MTR, the engine is rotated by the starter, but ignition and start fuel circuits are deenergized. At START, the engine is rotated with start fuel and the ignition circuits are energized. MTR is selected during starting, in case of engine fire or to clear the combustion chamber.

b. *STARTER ON Indicator Lights.* The STARTER ON indicator lights will illuminate when the associated START switch is moved to MTR or START. The light alerts the pilots when the START switch is inadvertently left at MTR. Power is supplied by the No. 1 and No. 2 DC essential buses through the ENGINE NO. 1 and NO. 2 START & TEMP circuit breakers on the No. 1 and No. 2 PDP.

### 2-49. Ignition Lock Switch.

An ignition system lock switch (11, fig. 2-4) is installed on the right side of the console forward of the thrust lever. The key-operated switch prevents unauthorized use of the helicopter. When the switch is off, the circuits of the ignition exciters and the start fuel solenoids of both engines are open. Therefore, the engines cannot be started. Be sure both START switches are OFF before turning the ignition lock switch ON or OFF.

### 2-50. Engine Instruments and Cautions.

The engine instruments are the gas producer tachometer, the dual torquemeter, power turbine inlet temperature (PTIT), fuel flow, oil pressure and oil temperature indicators. The caution capsules are the NO. 1 and NO. 2 ENGINE OIL LOW and the NO. 1 and NO. 2 ENG CHIP DET.

**2-51. Gas Producer Tachometer.** Two gas producer tachometers (NI), one for each engine, are on the center instrument panel, above the PTIT indicators. Each tachometer displays gas producer turbine speed in percent of NI. Each tachometer operates from power supplied by a gas producer tachometer generator on the accessory gear box section of each engine. 712 The outer scale of the tachometer is calibrated from 0 to 100 in increments of two. The smaller, vernier scale is calibrated from 0 to 10, in increments of one. 714A The tachometer is calibrated from 0 to 110.

**2-52. Torquemeter.** One torquemeter is on the copilot instrument panel and the other on the pilot instrument panel (1, fig. 2-8 and 17, fig. 2-10). Each torquemeter has two pointers, one for each engine, labeled 1 and 2. Each torquemeter has a range of 0 to 150 percent. The system consists of a power output shaft, torquemeter head assembly, power supply unit, 714A ratio detector power supply unit (RDPS), and a torquemeter junction box. Power to operate the torquemeters is provided by No. 1 and No. 2 AC buses through the ENGINE NO. 1 and NO. 2 TORQUE circuit breakers on the No. 1 and No. 2 PDP. Power for the

power supply unit 714A and RDPS is provided by the No. 1 and No. 2 DC buses through the DC ENGINE NO. 1 and NO. 2 TORQUE circuit breakers on the No. 1 and No. 2 PDP.

### 2-53. Power Turbine Inlet Temperature Indicators.

Two power turbine inlet temperature (PTIT) indicators, one for each engine, are on the center instrument panel (7, fig. 2-9). Each indicator is calibrated from 0° to 1,200°C. The temperatures registered on the PTIT indicator are transmitted by chromel-alumel thermocouples. The thermocouples sense gas temperature at the power turbine inlet and transmit an average gas temperature reading to the PTIT indicator in the cockpit. 712 When power turbine inlet temperature increases to the emergency power range, the EMERG PWR indicator light will illuminate and DC power is supplied to the EMERGENCY POWER panel. 714A When power turbine inlet temperature increases to the contingency power range, the ENG CONT PWR master caution advisory panel capsule will illuminate.

**2-54. Engine Oil Pressure Indicator.** An engine oil pressure indicator on the center instrument panel is provided for each engine (17, fig. 2-9). Each indicator relates pressure sensed at No. 2 bearing by an oil pressure transmitter mounted near the engine. Each engine oil pressure indicator displays a pressure range from 0 to 200 psi. Power to operate the engine oil pressure circuit is supplied by the AC instrument buses through the ENGINE NO. 1 and NO. 2 OIL PRESS circuit breakers on the No. 1 and No. 2 PDP.

**2-55. Engine Oil Temperature Indicator.** TWO engine oil temperature indicators are on the center instrument panel (18, fig. 2-9). Each engine oil temperature indicator is calibrated from -70° to +150°C. A temperature probe within the lubrication lines of the engine, before the fuel-oil cooler, is the point at which the temperature is sensed. Power to operate the resistance-type oil temperature circuit is supplied by No. 1 and No. 2 DC buses through the ENGINE NO. 1 and NO. 2 OIL TEMP circuit breakers on the No. 1 and No. 2 PDP.

**2-56. Engine Caution Capsules.** 712 The following items are in reference to Fig. 2-51:

a. NO. 1 (2) ENGINE OIL LOW. This is illuminated when approximately 2 quarts of usable oil is remaining in the engine oil tank.

b. NO. 1 (2) ENG CHIP DET. This is illuminated if a detector is bridged by metal particles which may indicate impending engine or engine transmission failure.

c. NO. 1 (2) ENG N1 CONT. This is illuminated when the ECL is not in the STOP, GROUND or FLIGHT detent or when the ECL position does not agree with the N1 actuator position.

**2-56.1. Engine CAUTION/ADVISORY Capsules.** 714A The following items are in reference to Fig. 2-51.1:

a. ENG 1 (2) FAIL. Active when the engine failure logic in the DECU detects a failed engine condition. The engine failure logic is active when N1 is greater than 60% and the

ECL position is greater than 50°. The engine failure logic in each DECU is used to recognize any of following:

- (1) Power turbine shaft failure. N2 is greater than RRPM by more than 3 percent.
- (2) N1 underspeed. N1 speed drops below 48 percent.
- (3) Engine flameout.
- (4) Over temperature start abort (Primary mode only).
- (5) During normal shutdown as the N1 goes below 48 percent the ENG 1 (2) FAIL caution is illuminated for 12 seconds, this is a BIT self system check.
  - b. FADEC 1 (2). Active if Primary FADEC system hard fails.
  - c. REV 1 (2). Active if Reversionary FADEC system hard fails.
  - d. ENG 1 (2) OIL LVL. Active when approximately 2 quarts of usable oil is remaining in the engine oil tank.
  - e. ENG. 1 (2) CHIP DETR. Active if a detector is bridged by metal particles which may indicate impending engine or engine transmission failure.
  - f. ENG CONT PWR. Active when power turbine inlet temperature is in the contingency power range.

**2-57. Engine Chip Detectors.** The engine accessory section oil sump and engine transmission chip detector is electrically connected to the corresponding NO. 1 or NO. 2 ENG CHIP DET caution capsule on the master caution panel (fig 2-51). If a detector is bridged by metal particles which may indicate impending engine or engine transmission failure, the corresponding NO. 1 or 2 ENG CHIP DET caution capsule will illuminate. Also, the associated ENGINE CHIP DETECTOR or TRANSMISSION CHIP DETECTOR magnetic indicator on the MAINTENANCE PANEL (fig. 2-34) will latch. Refer to Chapter 9 for emergency procedures.

### 2-58. Engine Chip Detector Fuzz Burn-Off.

Helicopters equipped with the chip detector fuzz bum-off system in the engine are identified by a module labeled PWR MDL CHIP BURN-OFF located below the MAINTENANCE PANEL. The chip detector fuzz bum-off system employs an automatically operated fuzz burn-off electrical circuit with the ability to eliminate nuisance chip lights caused by minute ferrous metallic fuzz or ferrous metallic particles on the engine accessory gear box (AGB) chip detectors. The response time of the fuzz bum-off circuit is more rapid than that of the helicopter warning system; thus a successful fuzz bum-off will be accomplished before any caution capsule on the master caution panel illuminates. Should the particle or particles not bum-off, the NO. 1 or NO. 2 .ENG CHIP DET caution capsule will illuminate. Also, the corresponding ENGINE CHIP DETECTOR or TRANSMISSION CHIP DETECTOR magnetic indicator on the MAINTENANCE PANEL will latch. Power for the PWR MDL CHIP BURN-OFF is supplied by the No. 1 DC bus through the HYDRAULICS MAINT PNL circuit breaker on the No. 1 PDP.

### 2-59. Engine Interstage Air Bleed.

#### NOTE

Bleed band oscillations at low torque settings (approximately 30% torque per engine), indicated by fluctuating engine RPM and torque, can occur and are not cause for engine rejection.

To aid compressor rotor acceleration and prevent compressor stall, an interstage air bleed system is provided on each engine. A series of vent holes through the compressor housing at the sixth stage vane area allows pressurized air to bleed from the compressor area. This enables the compressor rotor to quickly attain a preselected RPM. The pneumatic interstage air bleed actuator controls operation of the air bleed by tightening or loosening a metal band over the vent holes. Should the bleed band malfunction and remain open, there would be a noticeable loss in power. **712** The interstage air bleed system operates automatically when the ENG COND levers or the engine beep trim switches are used to govern RPM. **714A** The interstage air bleed system operates automatically through the FADEC system.

### 2-60. Engine Drain Valves.

Pressure-operated engine drain valves are in the bottom of each engine combustion housing. The valves automatically drain unburned fuel from the combustion chamber following an aborted start or whenever the engine is shut down. One valve is at the forward end of the combustion chamber and the other is at the aft end to ensure complete drainage.

**2-60.1. FADEC Description.** **714A** Each engine is controlled by its own Full Authority Digital Electronic Control system (FADEC) which provides the following features:

- a. Automatic start scheduling.
- b. 1 and 2 engine load sharing.
- c. Power turbine speed governing.
- d. Transient load anticipation (using rotor speed and collective pitch rates).
- e. Transient torque smoothing (using N2 rates)
- f. Contingency power capability to meet aircraft demands.
- g. Acceleration and deceleration control.
- h. Engine temperature limiting throughout the operating range.
  - i. Surge avoidance.
  - j. Compressor bleed band scheduling.
  - k. Fuel flow limiting.
  - l. Engine fail detection.
  - m. Power assurance test.
  - n. Engine history/fault recording.
  - o. Engine-to-engine communication (via data bus).
  - p. Automatic switchover to reversionary backup in the event of a FADEC primary system failure.

The FADEC provides automatic engine start, simultaneously sequencing ignition, start fuel, and stabilized operation at idle. A data link between 1 and 2 engine FADEC systems transmits signals to achieve load sharing. It also provides control of N1 speed and NR (N2) output shaft speed to maintain the rotor system at a near constant RRPM throughout all flight power demand conditions. FADEC provides smooth acceleration and overtemperature protection when ECLs (both together) are moved from GROUND to FLIGHT. Overtemperature protection is provided (through the DECU temperature limiting function) by control system thermocouple interface at the power turbine inlet. The control system compares PTIT temperature signals with reference limits to calculate and provide appropriate N1 acceleration. During starts, an absolute 816°C limit is set and if exceeded an engine out indication and shutdown will occur. If compressor performance deteriorates for any reason, surge detection automatically allows recovery from compressor instability while protecting the engine from damage due to overtemperature..

The FADEC system consists of:

q. The Digital Electronic Control Unit (DECU) includes a primary mode and a reversionary section for backup (fig 2-19.3).

r. The Hydromechanical Metering Assembly (HMA), includes Hydromechanical Fuel Metering Unit (HMU) and fuel pump unit for all fuel metering to support both primary and reversionary fuel metering, a self-contained alternator for powering the FADEC electronics, primary and reversionary compressor bleed air control, and redundant speed sensing.

s. ENG COND panel (fig. 2-19.1).

t. FADEC control panel (fig. 2-19.2).

u. RPM INC/DEC (Beep) switch on THRUST CONT Lever.

(1) On 714A engine installations, engine beep switches are only active when in reversionary mode.

(2) Each switch is labeled NO. 1 or 2 which is used to adjust RRPM when in reversionary mode.

(3) Operation of the beep switches on the 714A in the reversionary mode are the same as for the 712 except that each switch operates respective engine independently. If only one engine is in reversionary mode, the RRPM will not change, as it is governed by the engine in primary mode.

## 2-60.2. Reversionary System. **714A**

### NOTE

Aircrew should be alert to the possibility of abrupt NR and engine power changes when operating the FADEC in single or dual engine REV mode (s).

The reversionary (backup mode) automatically takes control of the engine if the primary mode fails or if selected by the operator via the FADEC panel, REV switch.

When an engine is operating in reversionary mode, FADEC provides engine and rotor control through an N1 speed governor, beep control, and a thrust pitch compensator.

When both engines are in reversionary mode, RRPM will require more pilot attention since proportional rotor speed governor will not hold speed as accurately as the primary systems. With large collective changes, the rotor speed can change up to  $\pm 3$  percent from a nominal setting.

If a fault is detected and to ensure positive engagement of the reversionary mode, set the FADEC control REV/PRI switch for the affected engine to REV

The reversionary system provides the following control functions:

a. Automatic start sequencing including over temperature protection, but not start abort.

b. Pilot controlled start fuel enrichment/derichment, if required, through ECL modulation.

c. Ground idle set at **50 to 59 percent** with ECL at GND.

d. RRPM droop compensation based on thrust lever position.

e. Beep capability becomes active for load match to other engine.

f. Full contingency power capability.

g. Over temperature protection throughout operation.

h. Engine shutdown in response to ECL being placed at STOP.

i. Tracking of the primary mode during normal primary mode operation allowing a smooth switchover when selected.

If in reversionary mode for any reason (training) and there is a reversionary failure, the FADEC will not automatically switch back to the primary mode. The pilot must manually select PRI mode.

### CAUTION

**If both the primary and reversionary system fail, the engine remains at the fuel flow being used at the time of the failure. When a failed fixed fuel flow condition exists, the ECL and the beep trim switch for the affected engine is inoperative, therefore there is no proportional control through the ECL except under some conditions STOP. Engine shutdown may be accomplished by moving the ECL from its present position to STOP Under these conditions, the ENG 1 (2) FAIL and FADEC 1 (2) cautions are illuminated.**

When taking off with one engine in reversionary mode the procedure is, before lift-off, the engine still in PRI mode is used to set the correct rotor speed via the FADEC NR% switch. The operator then uses the beep switch of the engine in reversionary mode to match engine torque.

**2-60.3. ENG COND Panel. 714A**

**CAUTION**

**When adjusting controls or switches on the overhead switch panel, make sure gloves or sleeves do not catch and inadvertently move the ENG COND levers**

The ENG COND panel is located in the overhead switch panel (fig. 2-19.1).

NO. 1 and NO. 2 Levers. The ENG COND Levers (ECL) provide the pilot with proportional acceleration and deceleration authority. The levers are spring-loaded outboard creating a gated motion when advanced from the STOP to 1 / 2 GND and to FLT positions. ENG COND lever friction is provided to reduce the possibility of over-torquing transmissions by resisting rapid movement of the levers.

**2-60.4. FADEC Panel. 714A** The FADEC panel is located in the overhead switch panel (fig. 2-19.2). It comprises of the following:

a. *NR% Switch.* The NR% switch controls a rheostat which allows the operator to select any RRPM between 97% and 103%. There are detents at 97%, 100% and 103%. With the ECL(s) in FLT, NR will be maintained at the selected speed. 100% is the normal position.

b. *PRI/REV Switches.* The primary mode is the normal mode of operation. The REV (reversionary) mode is selectable as a backup mode or is automatically selected if the primary system has a hard fault failure. A hard fault failure is defined as one in which normal primary system performance might be jeopardized. Other failures are classified as soft failures when the system is fault tolerant and can continue fully operational with the fault signal present.

c. *B/U PWR Switch.* The Back-Up Power switch when ON connects the aircraft battery relay and essential relay.

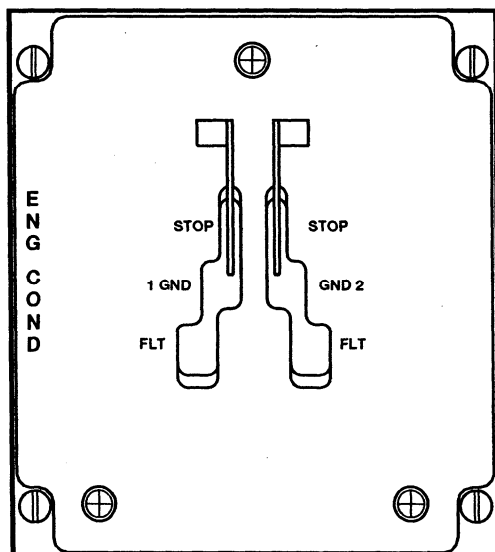
This provides the FADEC system with back up electrical power in the event of a HMU integral alternator failure thus preventing loss of the PRI mode. Placing the B/U PWR switch to OFF will reduce operating time on the FADEC circuitry. The B/U PWR switch should always be ON during engine operation.

d. *OSPD 1, 2 Switch.* The Over Speed test switch is a three position switch used to test the FADEC overspeed system. In the event of a NR over-speed of 114.8. percent, FADEC reduces fuel flow to a ground idle condition. The system remains activated until the over-speed condition no longer exists, and will re-activate as soon as an overspeed re-occurs. The system contains provisions to inhibit overspeed trip command if the other engine has experienced a overspeed trip condition. To prevent inadvertent operation during flight, this test is locked out if NR is greater than 81.3 percent. When performing an overspeed test with the engine running and the RRPM 79.0 ±1% and the function is locked out above 81.3 percent, pressing the test switch to 1 or 2, lowers the overspeed trip threshold to 79 ±1% NR. At this time the system senses an overspeed and reduces the fuel flow.

e. *LOAD SHARE, PTIT/TRQ Switch.* The primary FADEC system provides pilot selectable engine torque or PTIT matching to govern the engines. Torque matching is normally the preferred option. The selected parameter is constantly compared between the two engines until the RRPM stabilizes at a datum figure. The PTIT option may be used when one engine is running hot. N1 matching is engaged automatically if the selected matching mode fails.

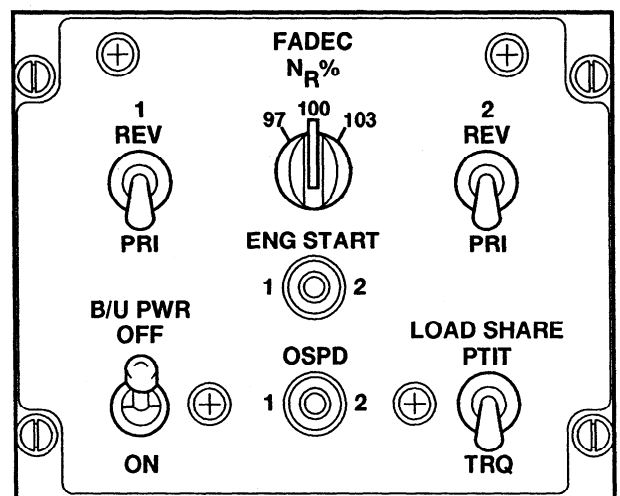
f. *ENG START Switch.* It is a three position switch, spring loaded to the center position, labeled 1 and 2. It is used to commence the start sequence on the respective engine.

**2-60.5. DECU Unit. 714A** The two airframe mounted DECU's, one for each engine, contain the primary and



A60881

Figure 2-19.1. Engine Condition Panel 714A



A60879

Figure 2-19.2. FADEC Panel 714A

reversionary mode electronics. The DECU's are located on the left and right side of the aft cabin at station 400 (fig. 2-19.3).

**2-60.6. BIT. 714A** The DECU contains a two-digit BIT display. When active, the display indicates the operating status of the FADEC system and power assurance test results. A complete list of the FADEC BIT fault codes are located at Table 2-1.1. The fault monitoring carried out by the DECU consists of:

- a. Power up tests.
- b. Fault tests designed to discover dormant faults.
- c. A set of repeated monitoring tests to detect faults occurring during normal operation.

Fault information for the previous or current engine cycle can be seen on the DECU BIT display. The last engine cycle is reset on the first occurrence of start mode and not on engine shutdown. During engine shutdown (when a ECL is at STOP or N1 is less than 10 percent) faults are not stored. Fault indications are stored in the DECU and are retained throughout the life of the control unit. However, fault information prior to the previous cycle can only be accessed with specialized test equipment. During engine start the DECU BIT displays 88 for a satisfactory test or if the test fails, a fault code. Faults are classified as either "HARD" or "SOFT". In primary mode a Hard fault will cause the FADEC to transfer to Reversionary, while in Reversionary a Hard fault will cause the FADEC to "fail fixed" to a constant power condition. If a hard fault occurs in Primary after a hard fault exists in reversionary then the primary will fail fixed. In the event of a soft fault the FADEC will remain in the mode it was in prior to the fault but there may be some degradation or redundancy. All soft faults are less severe than a Hard fault since the FADEC will not switch modes due to a soft fault.

The activation of the BIT display is dependent upon the position of the ECL as follows:

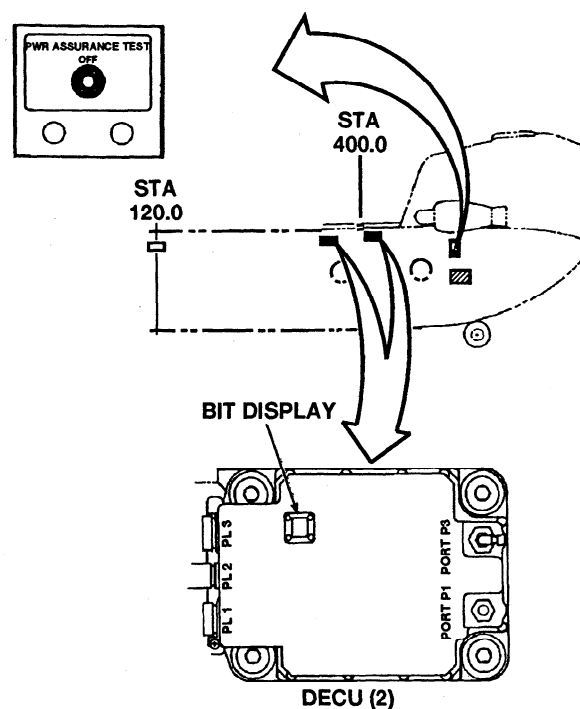
- a. With the ECL at STOP, the fault information for the last engine cycle and current faults are displayed.
- b. When the ECL is positioned at GROUND IDLE only current faults are displayed.
- c. When the ECL is positioned at FLIGHT the display will be turned off except as required for power assurance test

### 2-60.7. Starting in Primary Mode. 714A

#### CAUTION

**The (P3) compressor pressure signal line going to the DECU contains a manually operated moisture drain valve. This valve should not be drained while the engine is running.**

In primary mode, engine start is initiated with the ECL in the GND position. Select and hold the respective ENG START switch and allow the engine to accelerate to 10



A73381

Figure 2-19.3. DECU Panel 714A

percent N1 then release the ENG START switch. The automatic start sequence has been energized and FADEC will complete the start. When an engine start is energized, FADEC turns on the engine start solenoid to introduce fuel flow and energize the engine igniters. Successful engine ignition is immediately indicated to FADEC by an increase of PTIT or compressor speed (N1). Engine temperature is monitored throughout the sequence and will result in a fuel flow reduction if the temperature exceeds  $650^{\circ}\text{C}$  with a full cutback to minimum flow limit at  $760^{\circ}\text{C}$ . The starter motor and igniter are automatically turned off when N1 speed exceeds 48 percent. Ground idle is 50 to 59 percent and is corrected for temperature. The engine is allowed to take 45 seconds to stabilize at ground idle.

**2-60.8. Engine Start Abort. 714A** PTIT above  $816^{\circ}\text{C}$  will cause immediate fuel shutoff to below minimum fuel flow. The ECL must be retarded to STOP to achieve total fuel shutoff. A start abort results in the ENG 1 (2) FAIL warning to be illuminated until the abort is reset by moving the ECL to STOP

**2-60.9. Starting in Reversionary Mode. 714A** The initial start sequence in reversionary mode is the same as in primary mode except, when N1 reaches 8 percent, the control system turns on the engine start fuel solenoid to provide an initial altitude biased fuel flow and activates the igniters and latches the starter motor. The pilot can modulate fuel flow to the engine with ECL to start the engine at a desired acceleration rate. Temperature and temperature rate limiters are the same as in primary mode except that the over temperature start abort facility is not provided.



Alternate Reversionary Starting. For most conditions, a start is successfully completed with the ECL held at the GND position. However, if the engine fails to start due to either a rich or lean hung start condition, the pilot may use the ECL to increase or decrease the start flow as required to complete a successful start. If the engine fails to start using the normal starting procedure, proceed as follows:

a. Reversionary Rich Hung Start. A rich hung start is characterized by N1 holding at about 40 percent and PTIT climbing above 600°C. If a rich hung start is experienced:

- (1) Set the affected engine ECL to STOP.
- (2) Allow PTIT to decay to 260°C or below (motor engine as required).
- (3) Check N1 0 percent.
- (4) Advance ECL half the distance between STOP and GND (15°).
- (5) Motor engine using ENG START switch until 10% N1 and then release switch.

(6) After engine ignition (PTIT rising), slowly advance ECL to GND. Check that N1 is stabilized at ground idle.

b. Reversionary Lean Hung Start. A lean hung start is characterized by N1 hanging at approximately 30 percent and PTIT remaining below 500°C. If a lean hung start is experienced:

- (1) Slowly advance the hung engine ECL to achieve acceleration (maximum of one-third travel from GND to FLT).

(2) Retard the ECL to GROUND as ground idle speed is approached. Check that N1 is stabilized at ground idle,

**2-60.10. Starting Cycle, Aborting . and Motoring.**

**714A** A starting cycle can be aborted at any time by moving the ECL to STOP. If a motoring is required:

- a. Set the ECL to STOP.
- b. ENG START switch to 1 (2).
- c. Hold ENG START switch until PTIT decreases below 260°C.

**2-60.11. Power Assurance Test Switch. 714A** The primary FADEC will perform a BIT whenever the PWR ASSURANCE TEST switch has been placed to the desired engine position. The switch is located below the maintenance panel at station 524. The switch is labeled 1/OFF/2 and spring loaded to OFF. The results of the test are displayed in the DECU BIT window.

**2-60.12. Engine Wash System. 714A** The helicopter is equipped with an engine wash system for each engine. Air and water connections are externally mounted inboard of each engine work platform. A series of spray nozzles are installed at the engine inlet and air lines are routed to the bleed band actuator.

Table 2-1.1. FADEC Bit Fault Code List 714A

FAULT CODE	FAULT DESCRIPTION
10	Microprocessor hard fault
11	Non-volatile random access memory (RAM) check sum hard fault
12	Non-volatile RAM engine history data soft fault
13	Non-volatile RAM fault data soft fault
14	Non-volatile RAM accumulated fault data soft fault
15	Non-volatile RAM write test soft fault
16	Non-volatile RAM storage incomplete
17	Non-volatile RAM history data inconsistent
18	Minor cycle not competed hard or soft fault
1B	Engine monitoring system cycle not completed soft fault
1C	Analog-to-digital conversion not completed hard fault or soft fault
1E	RAM failure hard fault
1F	Opcode error hard fault
A1	Q sensor soft fault
A2	N2 set potentiometer soft fault
A3	Primary and reversionary collective pitch angle linear variable displacement transformer (LVDT) soft fault
A4	NR sensor soft fault
A5	Primary and reversionary ENG COND lever resolver soft fault
A6	Airframe emergency 28V DC supply soft fault
A7	Airframe +28V DC supply soft fault
B2	Primary or reversionary N1B sensor soft fault
B3	Primary or reversionary N2B sensor soft fault
B4	Primary or reversionary T4.5 sensor soft fault
B5	Primary or reversionary collective pitch angle LVDT soft fault
B6	Primary or reversionary ENG COND lever resolver soft fault
B7	Primary or reversionary power level angle potentiometer soft fault
B9	Primary or reversionary cold junction compensation for temperature signal soft fault
BA	Reversionary +28V soft fault
BB	Reversionary T4.5 calibration soft fault
BC	Primary or reversionary 400Hz resolver reference soft fault
C1	Communication line soft fault on T4.5 (0) signal
C2	Communication line hard or soft fault on P1 (0) signal
C3	Communication line hard or soft fault on T1 (0) signal
C4	Communication line soft fault on Q (0) signal
C5	Communication line soft fault on N2 SET (0) signal
C6	Communication line soft fault on collective pitch angle (0) signal

FAULT CODE	FAULT DESCRIPTION
C7	Communication line soft fault on NR (0) signal
C8	Communication link soft fault
C9	Communication line soft fault on N1B (0) signal
CF	Loss of load share signals hard fault
D0	Overspeed drive soft fault
D1	P3 transducer soft fault
D2	P1 transducer soft fault
D3	28V "OR" diodes soft fault
D4	+10V reference hard fault
D5	±15V hard fault
D6	+12V reversionary or ±12V overspeed soft fault
D7	+5V hard fault
D8	Primary and reversionary cold junction compensation for temperature signal soft fault
D9	+24V regulator soft fault
DA	+5V reversionary soft fault
DB	Reversionary system soft fault or idle check soft fault
DC	T4.5 calibration soft fault
DD	Over-speed check soft fault
DE	Primary and reversionary 400Hz resolver reference soft fault
DF	Watchdog timer test hard fault
E1*	Primary and reversionary T4.5 sensor soft fault
E2*	T1 sensor soft fault
E3*	N2A sensor soft fault
E4*	Primary and reversionary N2B sensor hard fault
E5*	N2A/N2B difference soft fault
F1	N1A sensor soft fault
F2	Primary and reversionary N1B sensor hard fault
F3	N1A/N1B difference soft fault
F4	MV potentiometer hard or soft fault
F5	Fuel flow stepcount difference hard fault
F6	Primary and reversionary power level angle potentiometer soft fault
F7	Bleed valve solenoid hard fault
F8	Primary/Reversionary solenoid hard fault
F9	Alternator voltage soft fault
FA*	Start fuel solenoid soft fault
FB	Reversionary step count soft fault

\*Denotes engine related faults.

## SECTION IV FUEL SYSTEM

### 2-61. Fuel Supply System.

The fuel supply system furnishes fuel to the two engines, the heater, and the APU. Two separate systems, connected by crossfeed and a pressure refueling lines are installed. Provisions are available within the cargo compartment for connecting Extended Range Fuel System (ERFS) and ERFS II to the two fuel systems.

Each fuel system consists of three fuel tanks contained in a pod on each side of the fuselage. The tanks are identified as forward auxiliary, main, and aft auxiliary tanks. During normal operation, with all boost pumps operating, fuel is pumped from the auxiliary tanks into the main tanks, then from the main tanks to the engine. A simplified fuel flow diagram is engraved on the FUEL CONTR (control) panel on the overhead switch panel (fig. 2-20).

When the fuel is consumed in an auxiliary tank, the fuel pump is automatically shut off and a check valve closes to prevent fuel from being pumped back into that tank. Should a fuel pump fail in an auxiliary tank, the fuel in that tank is not usable. However, should both boost pumps fail in a main tank, fuel will be drawn from the main tank as long as the helicopter is **below 6,000 feet** pressure altitude (PA).

Fuel is delivered to the APU from the left main tank and to the heater from the right main tank. Fuel system switches and the auxiliary tank low pressure indicating lights are on the FUEL CONTR panel, the fuel line pressure caution capsules are on the master caution panel, and the fuel flow meter is on the center instrument panel. The single point pressure refueling panel and nozzle adapter are on the right side above the forward landing gear. Refer to Section XV for fuel tank capacities, fuel grades, and fuel system servicing procedures.

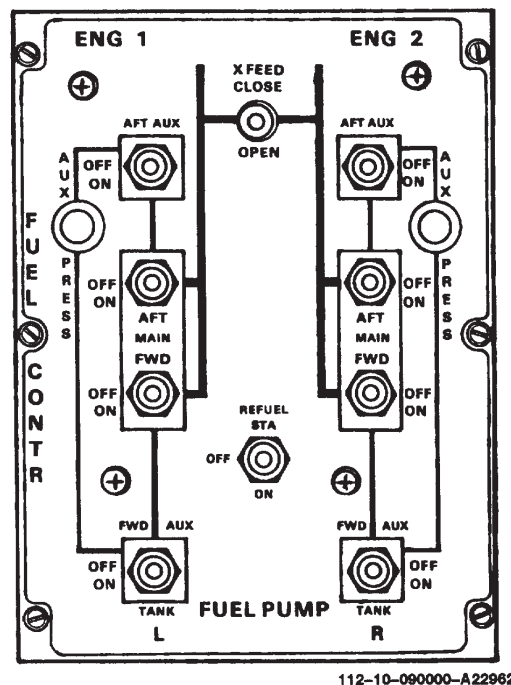
### 2-62. Fuel Tanks.

The fuel tanks are crashworthy self-sealing tanks with breakaway fittings. The main fuel lines are constructed of self-sealing material. Penetration of the tank wall or a fuel line by a projectile exposes the sealant to the fuel, activates the sealant, and close the hole.

Breakaway self-sealing fittings are installed where the main fuel lines connect to the fuel tank and adjacent structure. Under high impact loads, the fittings shear or break at predetermined locations, seal themselves, retain the fuel, keeping fuel loss and post-crash fire hazard to a minimum. Electrical cables having lanyard-release type connectors are installed where the cables attach to adjacent structure. The connectors automatically release if the fuel tank breaks away from the pod.

Each main tank contains two fuel boost pumps, three fuel

quantity probes, a jet pump for evacuating the pressure refueling system, a dual pressure refueling shutoff valve, a dual fuel level control valve, and a gravity filler port. Each auxiliary tank contains a fuel pump with automatic shutoff feature, a quantity probe, a dual pressure refueling shutoff valve, and a fuel level control valve.



112-10-09000-A22962

Figure 2-20. Fuel Control Panel

A rollover vent system is installed in each tank. This system prevents fuel spillage from the vents should the helicopter roll over following a crash landing. The vent system within the tanks have a condensate drain at the aft end, however, aircraft maneuvering should never force fuel into the vents. Sump drains are also installed on the bottom forward end of each tank.

### 2-63. Controls and Indicators.

The fuel controls are the FUEL PUMP switches, XFEED fuel valve switch, the engine fuel valve, and the manual defueling valve. Indicators include the crossfeed fuel and engine fuel valve warning lights, the FUEL QUANTITY indicator and caution capsules, FUEL flow indicator, AUX PRESS indicating lights, and FUEL PRESS caution capsules. Refer to para. 2-70 for a description of the pressure refueling system controls and indicators.

**2-64. FUEL CONTR Panel.** The FUEL CONTR panel (fig. 2-20) consists of eight two-position fuel boost pump switches, two PRESS-TO-TEST AUX PRESS indicating lights, a two-position XFEED switch, and a two-position REFUEL STA switch.

a. *FUEL PUMP Switches.* Each switch controls a single-speed electrically driven fuel boost pump. Labeled next to each switch is the name of the pump which it operates. Each switch has an ON and OFF position. When one of these switches is at ON, power from the No. 1 or No. 2 DC bus closes the respective pump relay connecting power from the No. 1 or No. 2 AC bus to energize the pump. When switch is at OFF, the relay circuits open and power from the No. 1 and No. 2 AC bus is de-energized thus shutting off the pump. Power is supplied for these relay circuits by the No. 1 and No. 2 DC bus through the LH and RH FUEL PUMP CONT - AUX AFT, MAIN AFT, MAIN FWD, and AUX FWD circuit breakers on the No. 1 and No. 2 PDP. Power is supplied to the pumps circuits by the No. 1 and No. 2 AC bus through the LH and RH FUEL PUMPS - MAIN FWD, MAIN AFT, AUX FWD, and AUX AFT circuit breakers on the No. 1 and No. 2 PDP.

b. *AUX PRESS Indicating Lights.* Each light is electrically connected to the forward and aft auxiliary tank pressure switches. When this indicating light illuminates, it indicates that the fuel pressure in-either the forward or aft auxiliary fuel line is below  $10 \pm 1$  psi. The auxiliary tank fuel boost pump switches must be at ON to provide electrical power to the indicating light. The light intensity can be adjusted by turning the light housing. Power is supplied to operate the indicating light by the No. 1 and No. 2 DC bus through the LH or RH FUEL PUMP CONT AUX FWD & AUX AFT circuit breakers on the No. 1 and No. 2 PDP.

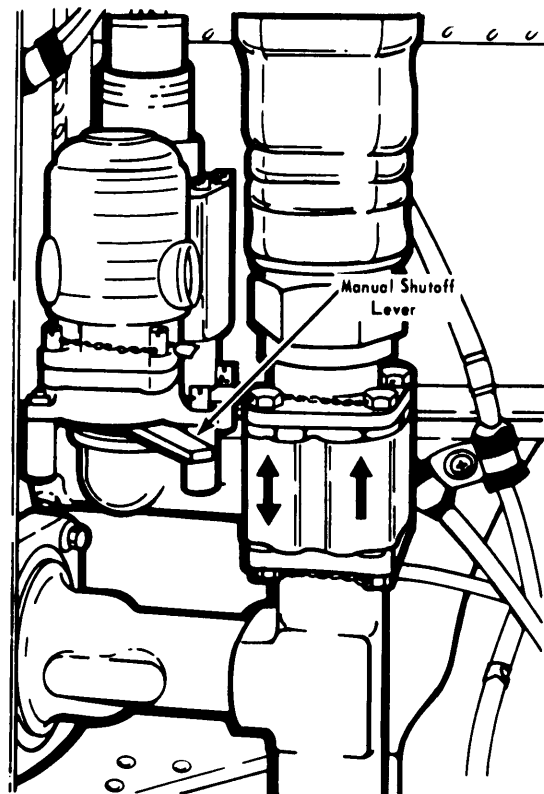
c. *XFEED Switch.* The switch electrically operates two fuel valves in the crossfeed line. The switch has an OPEN and CLOSE position. When the switch is at OPEN, power from the No. 1 DC bus opens the fuel valves through the XFEED CONT circuit breaker on No. 1 PDP. When the switch is at CLOSE, electrical power closes the valves.

**2-65. Fuel Valves.** There are two engine and two crossfeed fuel valves.

a. *Engine Fuel Valves.* One engine fuel valve (fig. 2-21) is in the fuel supply line to each engine. The valve is electrically operated by the FIRE PULL handles and manually by a lever on the valve. They are located at sta. 498 and labeled FUEL VALVE # 1 ENGINE and FUEL VALVE # 2 ENGINE.

b. *Crossfeed Fuel Valves.* The crossfeed fuel valves connects the No. 1 and No. 2 engine fuel lines. When the valve is opened, both engine fuel feed lines are interconnected and fuel can be supplied from both fuel tanks to feed either engine or from either tank to feed both engines. Fuel cannot be transferred between tanks. The valves are electrically operated by the XFEED switch on the FUEL CONTR panel or manually by a lever on the valve. They are labeled FUEL VALVE CROSS FEED and located at station 504.

c. *FUEL VALVE WARNING LIGHT.* There are two PRESS-TO-TEST FUEL VALVE WARNING LIGHT next to each FUEL VALVE CROSS FEED



D145-41-10

**Figure 2-21. Engine Fuel Valves, Sta. 498**

and two PRESS-TO-TEST FUEL VALVE WARNING LIGHT next to FUEL VALVE # 1 ENGINE and # 2 ENGINE (fig. 2-22). They indicate the operating condition of the individual valve and associated circuitry. Power is supplied to operate the crossfeed FUEL VALVE WARNING LIGHT by the No. 1 DC bus through the XFEED CONT circuit breaker on the No. 1 PDP. Power is supplied to operate the engine FUEL VALVE WARNING LIGHT by the DC essential bus through the ENGINE NO. 1 and NO. 2 FUEL SHUT-OFF circuit breakers on the No. 1 and No. 2 PDP.

The following description on when the light will illuminate is for the XFEED switch. The same result applies to the engine fuel valves with the FIRE PULL handles.

(1) Each time the XFEED switch is moved from CLOSE to OPEN or OPEN to CLOSE. After this operation, the light should extinguish, indicating the crossfeed valve is synchronized with the switch position.

(2) When a short circuit occurs, causing a signal to be applied opposite to the valve position. However, the valve will remain at the position last selected by the XFEED switch.

(3) When the crossfeed valve protection relay fails. The crossfeed valve will remain at the last selected position and the valve can be operated electrically or manually, as required.

**2-66. Manual Defueling Valve.** A manual defueling valve is in the aft cargo compartment next to FUEL VALVE # 2 ENGINE. The valve should only be used

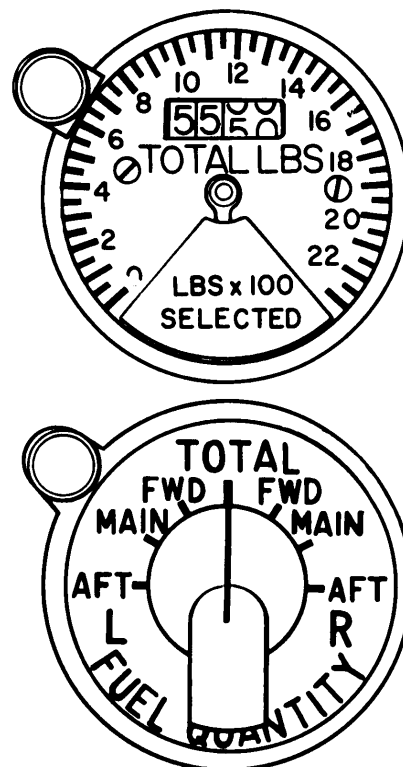
by maintenance personnel to defuel the helicopter or adjust fuel load.

**2-67. Fuel Quantity indicator and Selector**

**Switch.** An indicator calibrated to measure fuel quantity in pounds and a seven position selector switch (fig. 2-23) is on the center instrument panel. Power is supplied to the indicator through the FUEL QUANTITY selector switch by the No. 1 AC bus through the FUEL QTY circuit breaker on the No. 1 PDP.

a. *FUEL QUANTITY Indicator.* The indicator provides two types of display. One display is in digital form and the other is a pointer. The digital readout continuously indicates the total amount of fuel remaining in all the fuel tanks. The pointer remains hidden until one of the tank positions on the FUEL QUANTITY selector switch is selected. Then, the pointer will indicate fuel remaining in that tank. The fuel quantity indicator is electrically connected to 10 capacitance-type measuring units in the tanks.

b. *Fuel Quantity Selector Switch.* The fuel quantity selector switch has seven positions labeled TOTAL, L (left) and R (right) FWD, MAIN, and AFT. Selecting any position other than TOTAL causes the indicator pointer to display the fuel remaining in that tank. The digital readout is not affected during individual tank readings.



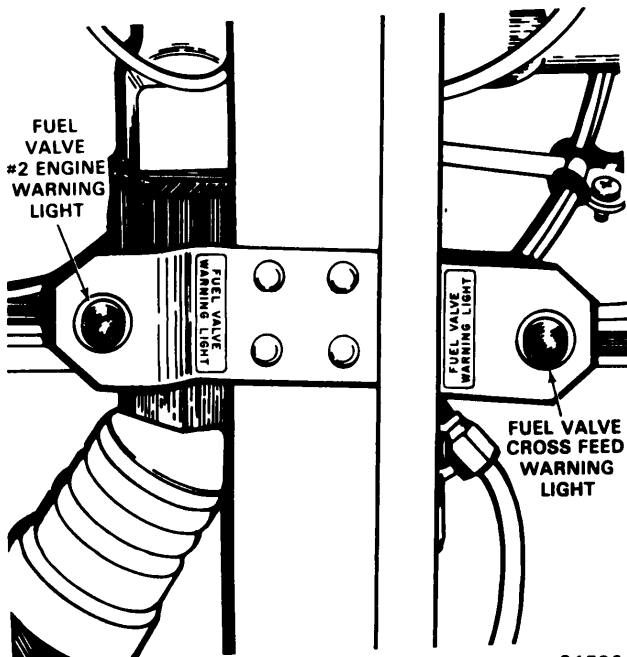
14619

**Figure 2-23. Fuel Quantity Indicator and Selector Switch**

**2-68. Fuel System Cautions.** Four caution capsules are dedicated to the fuel system.

a. *L and R FUEL LOW.* Two fuel quantity caution capsules, one for each main tank, are on the master

caution panel (fig. 2-51) of the center instrument console. Each light is electrically connected to a thermistor sensor on a measuring unit in the respective main tank. These lights are labeled L FUEL LOW and R FUEL LOW. When there is 20 percent of fuel remaining in the main tank, the caution capsule for that main tank illuminates (20 percent of fuel is equal to 320 to 420 pounds.) Power for these capsules is supplied by the DC essential bus through the LIGHTING CAUTION PNL circuit breaker on the No. 1 PDP.



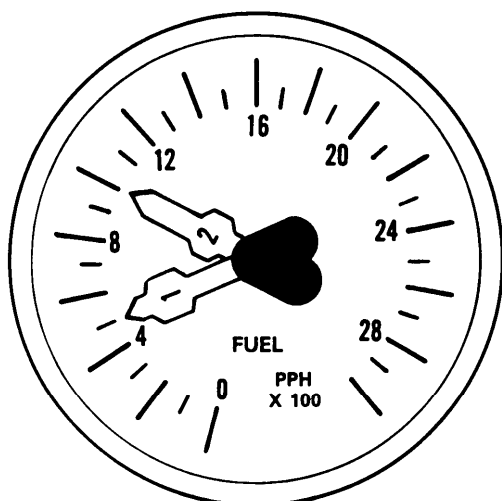
21596

**Figure 2-22. Fuel Valve Warning Light, Sta. 500**

b. *L and R FUEL PRESS.* Two caution capsules labeled L FUEL PRESS and R FUEL PRESS are on the master caution panel. Each caution capsule is electrically connected to a fuel pressure switch between the main tank and the engine fuel valves. When one of these capsules illuminates, it indicates that fuel pressure in the respective fuel line is below 10 ± 1 psi. Fuel pressure is measured after the fuel boost pumps and not at the engine driven pump. When a fuel pressure caution illuminates, it does not represent a possible engine flameout, unless flight is being conducted above 6,000 feet PA. Power for these capsules is supplied by the DC essential bus through the LIGHTING CAUTION PNL circuit breaker on No. 1 PDP.

**2-69. FUEL Flow Indicators.**

A dual fuel-flow indicator (fig. 2-24), on the center instrument panel, indicates fuel flow to each engine in pounds per hours. The indicator dial is graduated from 0 to 3000 pounds per hour in 100 pound increments. The signal to drive the indicator is derived from a fuel



23320

Figure 2-24. Fuel Flow Indicator

flow transmitter in the fuel line of each engine at the quick disconnect shelf. Power to operate the No. 1 indicator is from the No. 1 AC bus through the ENGINE NO. 1 FUEL FLOW circuit breaker on the No. 1 PDP. Power to operate the No. 2 indicator is from the No. 2 AC bus through the ENGINE NO. 2 FUEL FLOW circuit breaker on the No. 2 PDP.

### 2-70. Pressure Refueling System.

The pressure refueling system permits rapid refueling of all fuel tanks simultaneously or selective refueling of any tank or combination of tanks. Maximum fueling rate is **300** gallons per minute at **55** psi. The system control panel and refueling nozzle receptacle are on the right side of the helicopter above the forward right landing gear (fig. 2-25).

In addition to the control panel and refueling receptacle, the system consists of a dual fuel level control valve, a dual fuel shutoff valve in each tank, a jet pump in each main tank, and pressure refueling manifold.

a. *Dual Fuel Level Control Valves and Dual Fuel Shutoff Valves.* The dual fuel level control valves control the operation of the dual fuel shutoff valves. When fuel in a tank rises to the full level during pressure refueling, the floats in the control valve close and apply a signal to the shutoff valve, closing it. The floats can also be closed electrically to stop fuel flow into a tank at some intermediate level. The floats are controlled by the FUEL CELL SHUTOFF VALVE TEST switches on the refueling control panel.

b. *Jet Pumps.* The jet pump installed in each main tank evacuates the refueling manifold and discharges the displaced fuel into the main tank. The jet pump is activated when the forward boost pump in each main tank is first turned ON following pressure refueling.

c. *Pressure Refueling Manifold.* The pressure refueling manifold connects all tanks to the pressure refueling receptacle. It does not include projectile resistant features because the fuel is evacuated before flight by the jet pumps.

Electrical power is applied to the system only when the REFUEL STA switch on the cockpit FUEL CONTR panel is placed to ON. Power to operate the pressure refueling system is supplied by the DC switched battery bus through the REFUEL circuit breaker on the No. 1 PDP.

### 2-71. Controls and Indicators.

Except for the REFUEL STA switch on the cockpit FUEL CONTR panel, all pressure refueling system controls and indicators are on the pressure refueling station panel (fig. 2-25).

**2-72. PWR Control Switch.** The PWR (power) control switch is labeled ON and OFF. When placed to ON, electrical power is applied to the pressure refueling system and to the refueling station quantity indicator provided the REFUEL STA switch on the cockpit FUEL CONTR panel is at ON. Also, the PWR ON light will illuminate, the fuel quantity indicator will register the quantity of fuel in the tanks, and the REFUEL VALVE POSN lights will illuminate momentarily. When placed to OFF, electrical power is removed,

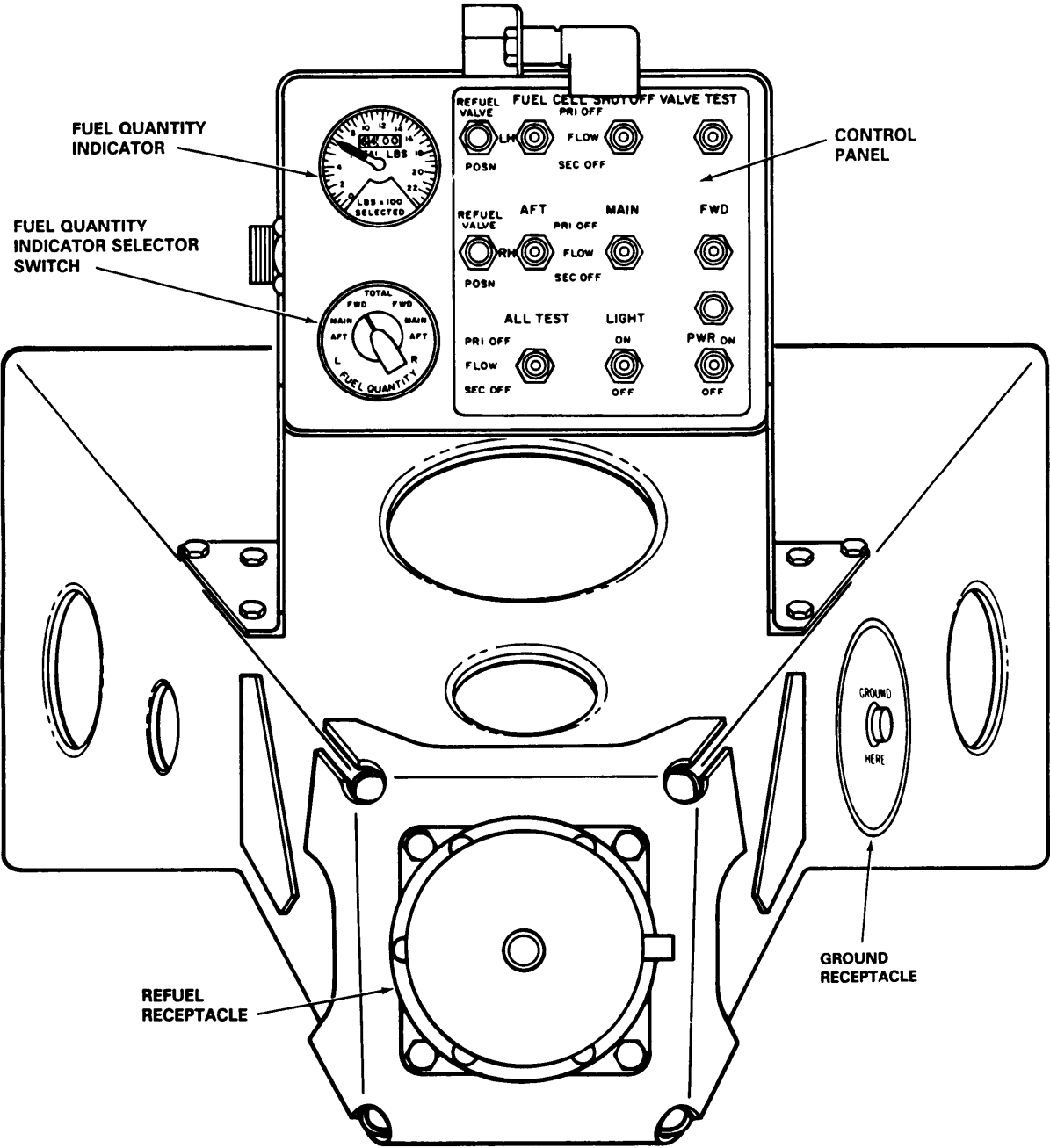
**2-73. REFUEL STA Switch.** The REFUEL STA switch is on the cockpit FUEL CONTR panel (fig. 2-20) when placed to ON, applies electrical power from the DC switched battery bus to the PWR ON switch on the refueling station panel. Setting the switch to OFF after pressure refueling, closes the refuel valves and discontinues electrical power to the refueling panel. When pressure refueling, be sure the switch is at ON at all times. If the switch is at OFF, the aft auxiliary tanks will not fill, the remaining four tanks will fill to maximum, the refuel station quantity indicator is inoperative, and there is no precheck capability.

### 2-74. Fuel Quantity Indicator and Selector

**Switch.** The pressure refueling station fuel quantity indicator and selector switch (fig. 2-25) are identical to those in the cockpit. The indicator at the refueling station indicates fuel quantity only when the REFUEL STA switch on the cockpit FUEL CONTR panel (fig. 2-20) is at ON and the PWR switch on the refueling station panel (fig. 2-25) is at PWR ON. Electrical power to drive the indicator is AC from a solid-state inverter in the cabin at sta 220. The inverter, in turn, is powered by the DC switched battery bus through the FUEL REFUEL circuit breaker on the No. 1 PDP.

### 2-75. FUEL CELL SHUTOFF VALVE TEST

**Switches.** Seven three-position FUEL CELL SHUTOFF VALVE TEST switches are on the refueling control panel (fig. 2-25). The switches are used to test the automatic shutoff features in each tank and to stop refueling when the desired fuel level is attained in each or all tanks. Six of the seven switches are connected to fuel level control valves in a specific tank. The seventh switch, labeled ALL TEST, is electrically connected to the fuel level control valves in all six tanks. Setting any of the six switches to PRI OFF or SEC OFF raises the corresponding primary or secondary float in the fuel level control valve. This action simulates a high fuel



23321

Figure 2-25. Pressure Refueling Station

level and causes the fuel shutoff valve in that tank to close. Setting the ALL TEST switch to PRI OFF or SEC OFF raises the corresponding float in all six tanks and shuts off the fuel flow into all tanks simultaneously.

**2-76. REFUEL VALVE POSN Indicating Lights.** The two amber PRESS-TO-TEST REFUEL VALVE POSN (position) lights (fig. 2-25) indicate the status of the two refueling valves in the pressure refueling system. The valves are normally closed and prevent fuel feedback into the aft auxiliary tanks when the aft tank pumps are operating. While pressure refueling, the valves are

opened and allow fuel flow from the refueling system into the aft tank,

The valves are controlled by the refueling station PWR ON switch. When the switch is ON, the valves are opened and the indicating lights will illuminate momentarily indicating valve transitioned from close to open. Conversely, when the switch is OFF, the valves are closed and the indicating lights will illuminate momentarily indicating valve transitioned from open to close. A continuously illuminated light, with the switch at OFF, indicates the associated valve is opened and the fuel in that tank will not be available.



**SECTION V FLIGHT CONTROLS**

**2-77. Flight Control System.**

The helicopter is controlled by changing the pitch of the blades either collectively or cyclically. Pitch changes are made by the pilot's movement of the flight controls which include a THRUST CONT (control) lever, a cyclic control stick, and directional pedals. The pilot's controls are interconnected with the copilot's controls.

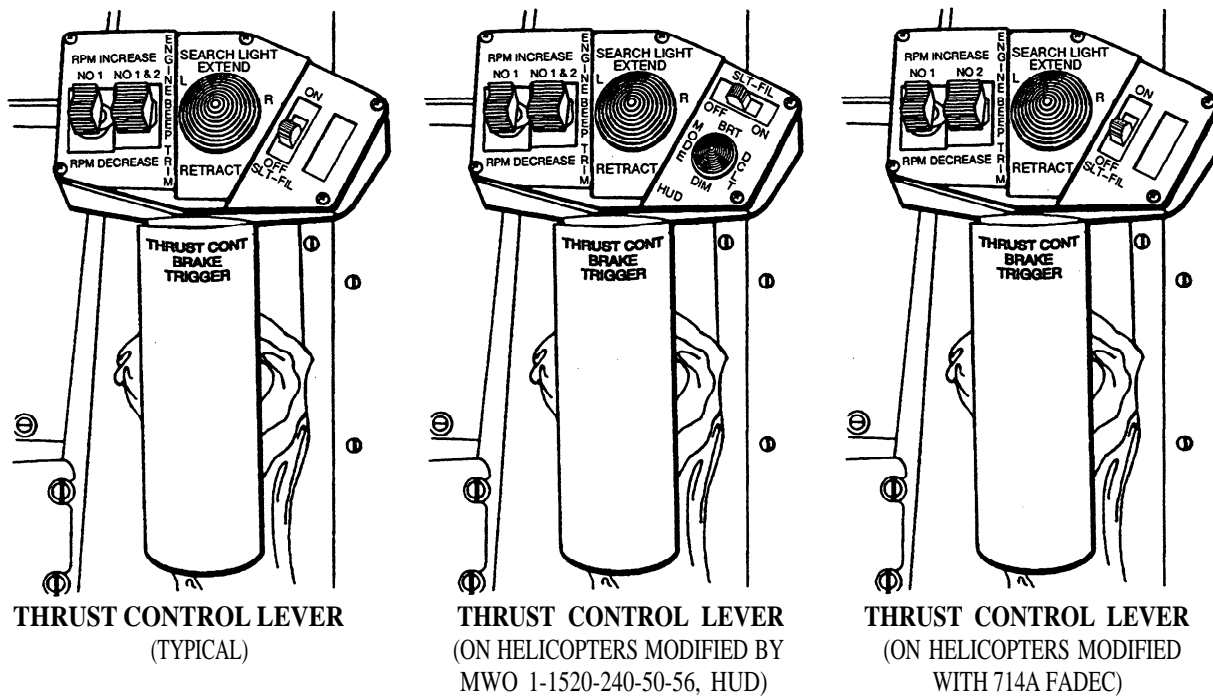
Flight control movements are transmitted through a system of bellcranks, push-pull tubes, and actuators to a mixing unit just aft of the cockpit, next to the forward transmission. The control movements are mixed to give the correct lateral cyclic and collective pitch motions to the rotors through dual hydraulic actuators. These dual boost actuators are under each swashplate. Each set of dual boost actuators is normally powered by both flight control hydraulic systems.

The helicopter is vertically controlled with the THRUST CONT lever through application of equal pitch to all blades. Directional control is obtained with the directional pedals

by imparting equal but opposite lateral cyclic pitch to the blades. Lateral control is obtained by application of equal lateral cyclic pitch to the blades with the cyclic control stick. The helicopter is controlled longitudinally with the cyclic stick through application of differential collective pitch.

In addition, the helicopter has an advanced flight control system (AFCS). AFCS provides the following features:

- a. Rate damping in all axes and sideslip stability.
- b. Pitch and roll attitude hold and heading hold.
- c. Airspeed hold.
- d. Improved control response in pitch, roll, and yaw.
- e. Barometric and radar altitude hold.
- f. Automatic coupled turns.
- g. Longitudinal cyclic trim scheduling.



A73382

*Figure 2-26. Thrust Control Lever*

**2-78. THRUST CONT Lever.**

Either THRUST CONT lever **712** (fig. 2-26) or **714A** [fig. 2-26) is used to apply equal pitch simultaneously to both rotors, thus controlling ascent and descent of the helicopter. Raising the THRUST CONT lever increases pitch. Lowering the THRUST CONT lever decreases pitch.

An integrated lower control actuator (ILCA) is installed between the THRUST CONT lever and the mixing unit. This actuator assists the pilot in moving the THRUST CONT lever. A cockpit control driver actuator (CCDA) is also installed in the thrust control system. This actuator responds to signals from the AFCS and increases or decreases collective pitch on the blades to maintain a constant altitude. In addition, a balance spring is installed that counteracts the downward imbalance of the THRUST CONT level.

**NOTE**

If the THRUST CONT lever CCDA fails, the THRUST CONT lever will slip when a force between 7 and 23 pounds is applied.

A BRAKE TRIGGER switch under each THRUST CONT grip controls the magnetic brake of the CCDA in the flight control closet. Pressing the switch applies electrical power to release the magnetic brake in the THRUST CONT lever CCDA. The THRUST CONT lever can then be freely moved.

When barometric or radar altitude hold has been selected, pressing the trigger will disengage altitude hold. When the switch is released, power is applied through the simplex clutch to the THRUST CONT lever CCDA and the AFCS will hold the altitude. Power is supplied to operate the THRUST CONT lever magnetic brake from the DC essential bus through the THRUST BRAKE circuit breaker on the No. 1 PDP

The **712** THRUST CONT lever is also electrically linked to the power turbine actuator through the droop eliminator system. An upward movement of the THRUST CONT lever electrically increases the power turbine governor speed setting to compensate for inherent engine droop and maintain engine speed as rotor loads are increased. A downward movement of the THRUST CONT lever electrically decreases the power turbine governor speed setting.

The **714A** 714A system includes both thrust lever position compensation and thrust lever rate compensation.

A detent capsule establishes a ground operation detent to reduce droop stop pounding. A viscous damper in the thrust control system improves control feel. Mounted on each THRUST CONT lever is an auxiliary switch bracket containing a SEARCH LIGHT control switch, a SLT-FIL (search light filament) switch, two ENGINE BEEP TRIM switches, and a HUD control switch.

**2-79. Cyclic Stick**

Each cyclic stick (fig. 2-27) is used for lateral and longitudinal control of the helicopter. Moving the cyclic stick to the right tilts both rotor disks equally to the right and causes the helicopter to roll to the right in flight. Moving the cyclic stick to the left causes the opposite movement. When moving the cyclic stick forward, the pitch of the fwd rotor blades is decreased collectively while the pitch of the aft rotor blades is increased collectively, thus causing a nose-down helicopter attitude in flight. Moving the cyclic stick aft causes the opposite movement resulting in a nose-up attitude.

Two ILCA's, one for lateral control and one for longitudinal control, are installed to assist the pilot in moving the cyclic stick. In addition to these actuators, viscous dampers are installed. One damper is for longitudinal control and one for lateral control to improve control feel.

Located on the pilot and copilot cyclic stick grips are a CENTERING DEVICE RELEASE switch, an AFCS trim switch, a CARGO HOOK RELEASE switch, interphone-transmitter TRIGGER switch, and a FLARE DISP (dispenser) control switch.

**2-80. CENTERING DEVICE RELEASE Switch.** The CENTERING DEVICE RELEASE switch (fig. 2-27) is used to simultaneously release the force feel trim magnetic brakes for the lateral, longitudinal, and directional flight controls. In addition, it disengages bank angle hold, heading hold, and heading select functions when AFCS is operating. Power is supplied to operate the magnetic brakes from the DC switched battery bus through the CONT CENTER circuit breaker on the No. 1 PDP.

A centering spring and a magnetic brake for each control provide a sense of force feel to hold the control in a trim position. However, the pilot can override the force manually while maneuvering the helicopter. When the switch is pressed, electrical power is applied to release the magnetic brakes. Each centering spring assumes a new trim position where the control forces are nulled. Releasing the switch removes electrical power and applies the magnetic brakes. The centering springs are retained in their new positions.

**2-81. AFCS Trim Switch.****NOTE**

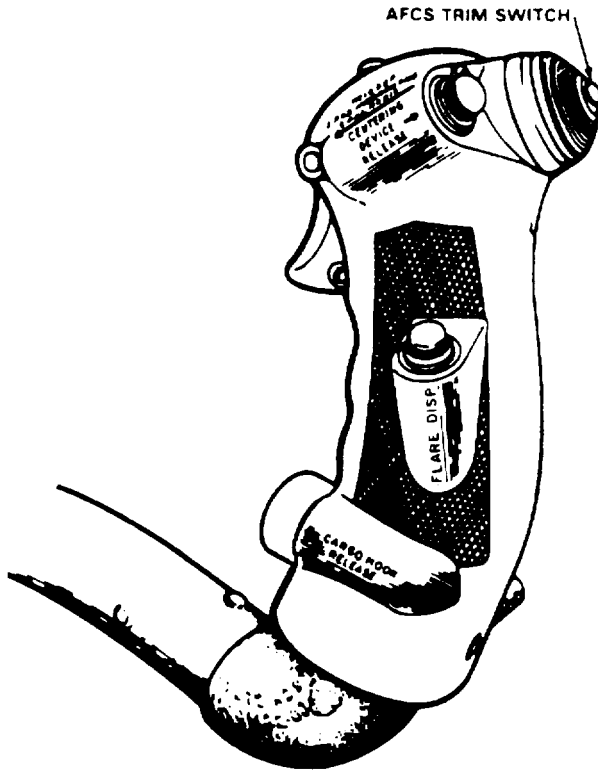
If the longitudinal CCDA fails, it can be recognized by loss of pitch trim or failure of the centering device to release. A centering spring in the pitch axis allows these forces to be over-come.

The AFCS trim switch (fig. 2-27) is used to make small changes in pitch (airspeed) and roll attitude while the AFCS is operating. The switch is spring-loaded to center off position. Moving the switch forward or aft from center off position commands an increase (forward) or decrease (aft) in airspeed by driving a trim motor in the longitudinal CCDA.

Moving the switch left or right commands the roll ILCA to bank the helicopter in the selected direction without moving the stick. Power is supplied to drive the pitch trim motor from the No. 1 AC bus through the CLTV DRIVER ACTR circuit breaker on the No. 1 PDP.

**2-82. Directional Pedals.**

The directional pedals (7 and 24, fig. 2-24) are used for directional control of the helicopter during flight and while taxiing with the forward gear off the ground.



**Figure 2-27. Cyclic Stick Grip**

When the right pedal is displaced forward, the forward rotor disk tilts to the right and the aft rotor disk tilts to the left. The opposite action occurs when the left pedal is displaced forward. An ILCA is installed to assist the pilot in moving the pedals.

The pedals are adjusted individually fore and aft by pressing a lever mounted on the pedal support and moving the pedal to a new position before repositioning the lever. Insure that both pedals are adjusted equally (left and right pedals in same respective hole position) and pedal adjustment lockpins are engaged. A balance spring is installed to stop pedal creep. A viscous damper is installed to reduce control sensitivity.

### 2-83. Advanced Flight Control System (AFCS).

a. The Advanced Flight Control System (AFCS) stabilizes the helicopter about all axes and enhances control response. It automatically maintains desired airspeed, altitude, bank angle, and heading. An automatic turn feature, coupled to the pilot or copilot HSI (horizontal situation indicator) is also included in the AFCS.

b. Built In Test Equipment (BITE) is installed in each AFCS computer. This equipment is intended for ground troubleshooting purposes only. An interlock circuit through the engine condition control box prevents BITE use anytime either ECL is out of STOP.

c. Power is supplied to the HDG ENGAGED, BARO ALT and RAD ALT ENGAGED lights from the DC essential bus through the CAUTION PNL circuit breaker on the No. 1 PDP. The No. 1 AFCS receives AC and DC power from the No. 1 AC and DC buses respectively through the AFCS NO. 1 circuit breakers on the No. 1 PDP. The No. 2 AFCS receives AC and DC power from the No. 2 AC and DC buses respectively through the AFCS NO. 2 circuit breakers on the No. 2 PDP.

d. The AFCS consists of the following components:

- (1) A cockpit control panel.
- (2) Two AFCS computers in the avionics compartment.
- (3) Three ILCA's in the flight controls closet.
- (4) A differential airspeed hold (DASH) actuator in the flight controls closet.
- (5) Two longitudinal cyclic trim (LCT) actuators are installed, one in the forward upper controls, the other in the aft upper controls.
- (6) Roll and yaw magnetic brakes, a longitudinal CCDA, and a thrust CCDA are all located in the flight controls closet.
- (7) Three control position transducers.

e. Attitude changes sensed by the attitude gyros, a yaw rate gyro in each AFCS computer, and the directional gyro are processed by the AFCS computers and applied to the ILCA's. The ILCA's extend or retract and move the upper flight controls. This control input is

not apparent to the pilot because AFCS control inputs do not move the cockpit controls. The pitch, roll, and yaw axis all operate in fundamentally the same manner. Should a hardover occur, the pilot can easily override AFCS.

f. Pitch attitude stability, airspeed hold, and a positive stick gradient from hover to Vmax are provided through the DASH actuator. The DASH actuator extends or retracts to maintain airspeed for a given stick position.

### 2-84. Bank Angle Hold.

Bank angle trim without cyclic stick movement is provided through left or right positioning of the cyclic stick AFCS trim switch. Bank angle hold is disengaged anytime a CENTERING DEVICE RELEASE switch is pressed, a cyclic stick is moved laterally, or the HDG switch is ENGAGED. Bank angle hold cannot be reengaged until the roll rate is **less than 1.5°** per second.

### 2-85. Heading Hold.

The directional gyro provides an input to each AFCS which signals the yaw ILCA to maintain heading within **5 degrees**. Heading hold is disengaged if the swivel switch is set to STEER or UNLOCK, a CENTERING DEVICE RELEASE switch is pressed, or the directional pedals are moved. Also, heading hold will be disengaged at airspeed **above 40** knots anytime lateral trim is used, the stick is moved laterally, or the HDG switch is ENGAGED. Heading hold will not resume until yaw rate is **less than 1.5°** per second at an airspeed **above 40** knots with a bank angle of **less than 1.5°**.

### 2-86. Airspeed Hold.

The airspeed hold feature provides a constant airspeed and pitch attitude relative to cyclic stick position at airspeeds **above 40** knots. Airspeed and pitch can be set with the AFCS trim switch on the cyclic stick or by displacing the cyclic stick until the desired airspeed is achieved then pressing the CENTERING DEVICE RELEASE switch. Refer to Chapter 8 AFCS Off Flight Characteristics.

### 2-87. Altitude Hold.

Two methods of altitude hold can be selected. They are radar altitude hold or barometric altitude hold.

a. *Radar Altitude Hold.* Radar altitude hold will maintain a more precise altitude in hover or over water flight than barometric altitude hold. Maximum altitude for the use of radar altitude hold is **1,500** feet AGL.

An error signal, caused by radar altitude deviations, is derived from the pilot radar altimeter receiver-transmitter and is processed by the No. 1 AFCS computer. The processed error signal is applied to the collective CCDA which drives the THRUST CONT levers in the direction necessary to null the error signal.

b. *Barometric Altitude Hold.* Barometric altitude hold is used in forward flight over terrain. It uses error signals produced within the No. 1 AFCS computer.

These error signals are in response to static pressure changes and are proportional to altitude changes. The signal is processed by the AFCS computer and applied to the collective CCDA which drives the THRUST CONT levers in the direction necessary to null the error signal.

**2-88. Heading Select,**

Heading select is engaged when the HDG switch on the AFCS panel (fig. 2-28) is pressed and the ENGAGED light illuminates. The heading bug on the selected HSI is the referenced heading. Rotating the HDG knob of the HSI to set the bug at a new referenced heading produces an error signal which is processed by the AFCS computers and applied to the roll ILCA. The roll ILCA then moves to produce a standard rate turn up to a **maximum bank angle of 2°** until the selected heading is captured. Heading select can only be selected at airspeeds **above 40** knots. Heading select is disengaged anytime a CENTERING DEVICE RELEASE switch is pressed, the HDG switch on the AFCS panel is disengaged, or when the opposite CMD SEL switch on the HSI MODE SELECT panel is pressed. .

**2-89. Longitudinal Cyclic Trim System.**

Longitudinal cyclic trim (LCT) control is part of AFCS. LCT reduces fuselage nose down attitude as forward airspeed is increased, thus reducing fuselage drag. The system also reduces rotor blade flapping which results in lower stresses on the rotor shafts. The LCT actuators are installed under the swashplates. Signals are transmitted to these actuators either automatically by AFCS or manually by CYCLIC TRIM switches on the AFCS panel. Landing gear proximity switches drive the actuators to GND (ground) operating position on ground contact.

**2-90. Controls and Indicators.**

**2-91. AFCS Control Panel.** The AFCS control panel (fig. 2-28) is on the canted console. It consists of the heading and altitude select, SYSTEM SEL (select), and CYCLIC TRIM sections.

a. *Heading and Altitude Select Switches.* The legend on these switches will dim when the PLT INST rotary control switch is placed out of the OFF detent.

(1) HDG Switch. The HDG (heading) switch is used in conjunction with the CMD SEL switch on either HSI MODE SELECT panel and the heading bug on either HSI to select coupled turns. The switch can be used only when airspeed is **above 40** knots. When the switch is pressed and either CMD SEL switch is pressed, the helicopter will automatically turn to and capture the heading bug on the selected HSI. In addition, the ENGAGED legend will illuminate. The switch is disengaged by pressing it again.

Heading intercept will be at a standard rate of **3°** per second up to a bank angle limit of **20°** at **133** knots. The helicopter must be trimmed before engaging the mode and cyclic stick control inputs should be avoided except for longitudinal AFCS trim inputs to adjust airspeed.

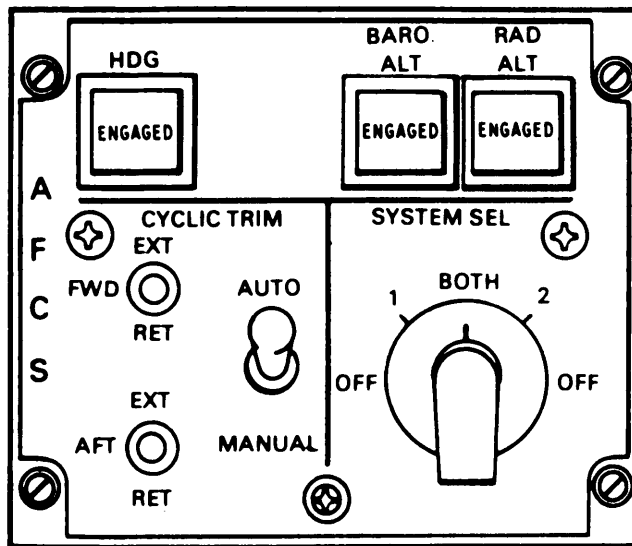


Figure 2-28. Advanced Flight Control System Panel

Heading select is disengaged if either CENTERING DEVICE RELEASE switch is pressed.

(2) BARO ALT and RAD ALT Switches. The BARO ALT and RAD ALT are used to select altitude hold mode. An interlock prevents both switches from being engaged at the same time. When pressed, the ENGAGED legend will illuminate. RAD ALT hold is used **below 1,500** feet AGL. BARO ALT hold is used in forward flight to maintain a constant cruise altitude or may be used in HOGE.

b. *SYSTEM SEL Switch.* The SYSTEM SEL switch is a five position rotary switch labeled OFF, 1, BOTH, 2, OFF. Normally, the switch is at BOTH. In this position, both AFCS are operating at **one-half** gain. If one system should fail, the good system is selected and that system operates at **3/4** gain. At OFF, both systems are inoperative except for CYCLIC TRIM.

c. *CYCLIC TRIM Switches.* The AUTO and MANUAL switch selects the mode of cyclic trim operation. The FWD and AFT switches are used to extend or retract the appropriate cyclic trim actuator.

(1) AUTO and MANUAL switch. A two-position switch which is normally placed in AUTO.

(a) AUTO Mode. In this mode, No. 1 AFCS controls the forward actuator and the No. 2 AFCS controls the aft actuator.

(b) MANUAL Mode. In this mode, the actuators can be controlled with separate FWD and AFT actuator control switches, using the airspeed indicator and the CYCLIC TRIM indicators.

(2) FWD and AFT switches. Three-position switches that can be placed in the EXT (extend) or RET (retract) position. These switches are spring-loaded to the center off position. If the cyclic trim actuators fail to

extend or retract as indicated on the CYCLIC TRIM indicators, MANUAL mode can be selected.

## 2-92. Cyclic Trim Indicators.

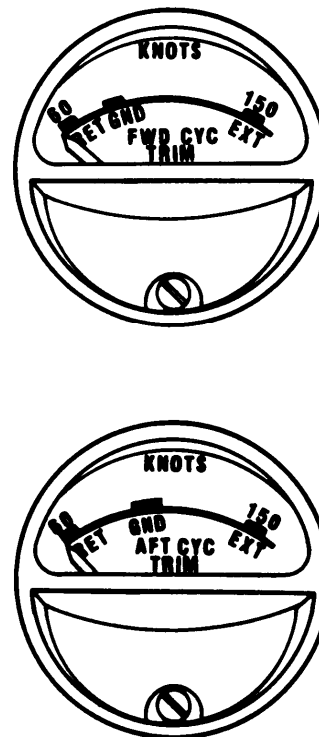
### **WARNING**

If the longitudinal cyclic trim actuators fail at the full retract position or are manually selected to the full retract position, do not exceed the airspeed limitations shown in fig. 5-6.

The FWD and AFT CYC (cyclic) TRIM indicators (fig. 2-29) are on the center instrument panel. The indicators are labeled 60 RET, GND, 150 EXT. The indicators display position of the forward and aft LCT actuators relative to airspeed. During ground operations, the pointer will be at GND to indicate activation of the landing gear proximity switches.

**2-93. AFCS OFF Caution.** Two AFCS OFF caution capsules are on the master caution panel (fig. 2-51). They are labeled NO. 1 AFCS OFF and NO. 2 AFCS OFF. These cautions will illuminate when the associated AFCS is manually shutoff or has failed or the associated DASH is in a low rate condition. Refer to Chapter 8 AFCS Off Flight Characteristics.

**2-94. Command Select Switch.** The CMD SEL switch is on the pilot and copilot HSI MODE SELECT panels (Chapter 3). The switches are used to select the HSI which will provide the referenced heading when the HDG switch is engaged. Only one CMD SEL switch may be selected at a time. If the other CMD SEL switch is selected during heading select operations, the HDG switch on the AFCS panel will disengage and heading select will be disabled until the HDG switch is again pressed. When selected, the SEL legend on the switch illuminates.



*Figure 2-29. Forward and Aft Cyclic Trim Indicators*

## SECTION VI HYDRAULIC SYSTEMS

### 2-95. Hydraulic Power Supply System.

The hydraulic power supply system consists of three separate systems. They are the No. 1 flight control system, No. 2 flight control system, and a utility system. Each system includes a variable delivery pump and a reservoir cooler. In addition, each flight control system has a power control module, and the utility system has a pressure control module. Each flight control system is connected to the utility system by a power transfer unit (PTU). All systems are serviced by a common fill module and are pressurized to prevent pump cavitation.

### 2-96. Flight Control Systems.

The No. 1 and No. 2 flight control systems are identical. They are parallel in operation, hydraulically separated, and electrically integrated. The flight control systems operate at approximately **3,000** psi, which is reduced to **1,500** psi for ILCA operation. They power four dual upper boost actuators (**3,000** psi) and four dual ILCAs (**1,500** psi). Each flight control system powers one piston of each actuator.

No. 1 flight control system is pressurized by a pump on the forward transmission. No. 2 system is pressurized by a pump on the aft transmission. The power control modules consist of pressure-operated valves, accumulators, and pressure-line and return-line filters. No. 1 system power control module is in the forward pylon. No. 2 system power control module is in the aft pylon. The accumulators dampen low frequency pressure surges and provide stored hydraulic power for peak loads.

The PTU in each system allows ground checkout of the flight control systems with the rotors stopped. Each PTU consists of a pump driven by a hydraulic motor which is pressurized by the utility hydraulic system. The PTU's are controlled by the PWR XFER 1 and 2 switches on the HYD panel in the overhead switch panel.

**2-97. FLT CONTR Switch.** The FLT CONTR (flight control) switch is located on the HYD panel in the overhead switch panel (fig. 2-30). It is a three-position center locked switch labeled 2 ON, BOTH, and 1 ON. This switch can be used to turn off one of the flight control systems, provided the other one is operating. Turning off one of the flight control hydraulic systems disables the corresponding AFCS and causes the remaining AFCS to make full corrections. In addition the respective AFCS OFF and HYD FLT CONTR caution capsules will illuminate. The FLT CONTR switch shall be set to BOTH during all flight conditions.

A1 BOTH. both solenoid valves are deenergized open and both flight control systems are pressurized. When the FLT CONTR switch is set to 1 ON, the two-way solenoid valve on No. 2 power control module is energized closed. This causes No. 2 pressure-operated valve to close, depressurizing No. 2 system. When the FLT CONTR switch is moved to 2 ON, the two-way solenoid valve on No. 2 power control module is deenergized open, and No. 2 system is pressurized. Simultaneously, No. 1 solenoid valve closes and No. 1 system is turned off.

### 2-98. Utility Hydraulic System.

The utility hydraulic system supplies hydraulic power to the wheel brakes, power steering actuator, swivel locks, centering cams, ramp actuating cylinders, hydraulic cargo door motor, actuator for the center cargo hook, cargo/rescue winch control valve, two engine starters, PTU's, and APU start circuit. When the APU is running, the utility hydraulic system is pressurized by an APU driven pump. When the APU is not running and the rotors are turning, the utility hydraulic system is pressurized by an aft transmission driven pump.

The utility hydraulic system incorporates a pressure control module which isolates utility subsystems from each other. When a failure occurs in one utility hydraulic subsystem, the remaining subsystems continue to operate normally if the BRK STEER and RAMP PWR switches in the cockpit are set to OFF.

The APU starting subsystem of the utility hydraulic system includes three accumulators which accelerate the APU to start, maintain reservoir pressure throughout the start cycle, and control operation of the APU motor pump. The APU starting subsystem also includes a two-stage hand pump for charging the APU start accumulators. The APU accumulator is normally recharged by the APU motor-pump after the APU is started. An additional accumulator in the brake system provides for limited brake operation in the event of utility hydraulic system failure. The steering system also

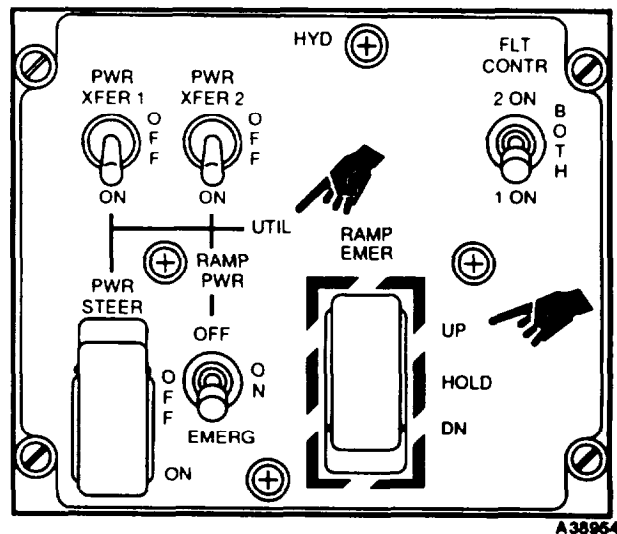


Figure 2-30. Hydraulics Control Panel

has an accumulator to keep the swivel locks engaged when the BRK STEER switch is OFF.

Normal operating pressure range for the utility hydraulic system is **2500 to 3500** psi. During APU operation pressure is increased to **approximately 3350** psi for engine starting. (See table 2-3 for flight control and utility hydraulic system capacities and fig. 2-54 for accumulator precharge pressures.)

**2-99. PWR XFER Switches.** The two-position PWR XFER (power transfer) 1 and 2 switches are located on the UTIL (utility) hydraulic portion of the HYD control panel (fig. 2-30). Each switch is labeled ON and OFF. If either switch is ON, 28-volt DC opens the normally closed solenoid valve in the corresponding PTU and opens a valve in the pressure control module. This allows utility hydraulic system pressure to operate the hydraulic motor pump on that PTU, pressurizing the flight control hydraulic system. Consequently, the flight controls can be operated on the ground for maintenance and checks without the rotors turning.

When both switches are ON, No. 1 and No. 2 flight control hydraulic systems will be pressurized. Both hydraulic motor pumps of the PTU's supply pressure for flight control operation. When the switches are OFF, the solenoid valves are closed and the flight controls cannot be operated unless the rotors are turning. Power for these switches is supplied by the No. 2 DC bus through the HYDRAULICS PWR XFER circuit breaker on the No. 2 PDP.

#### 2-100. RAMP PWR Switch.

##### **WARNING**

**When the RAMP PWR switch is at OFF, be sure the RAMP CONTROL valve is not moved from STOP. Operating the valve from STOP to UP or DN may cause the ramp to free fall.**

The RAMP PWR switch is on the lower right side of the UTIL hydraulic portion of the HYD control panel (fig. 2-30). The switch has three positions labeled ON, OFF, and EMERG. At ON, the ramp isolation valve in the utility system pressure control module is open, allowing system pressure for normal ramp operation. At OFF, the ramp isolation valve is closed, isolating the ramp system from the remaining utility systems. This prevents loss of utility system fluid if the ramp system fails. At EMERG electrical power is supplied to the RAMP EMER switch, allowing the ramp and cargo door to be opened and closed from the cockpit. Power to operate the RAMP PWR switch and ramp isolation valve is supplied by the No. 1 DC bus through the HYDRAULICS UTIL SYS CONT circuit breaker on the No. 1 PDP.

**2-101. BRK STEER Isolation Switch.** The BRK STEER isolation switch is on the HYD control panel (fig. 2-30). It is a guarded two-position switch labeled ON and OFF. At ON, the brake and steering isolation valve in the utility system pressure control module is open, allowing

system pressure for normal brake and steering operation. At OFF, the brake and steering isolation valve is closed, isolating the brake and steering subsystems from the remaining utility systems. ON is the normal flight position. OFF is used when there has been a hydraulic failure in the brake or steering system. Setting the switch OFF in this case prevents loss of system fluid. This allows the remaining utility subsystems to continue to function normally. The brake system contains an accumulator which allows limited system operation in a hydraulic failure. The swivel lock system also has a small accumulator which keeps the swivel locks locked with the system isolated. Power to operate the BRK STEER switch and valve is supplied through the HYDRAULICS BRK STEER circuit breaker on the No. 1 PDP.

#### 2-101.1. RAMP EMER Control Switch.

##### **WARNING**

**The RAMP EMER control switch is intended for emergency use only during smoke and fume elimination procedures. Inadvertent operation of the cargo ramp and cargo door from the cockpit may result in injury to personnel or damage to equipment.**

The momentary, guarded, three-position RAMP EMER (ramp emergency) control switch is located on the UTIL hydraulic portion of the HYD control panel (fig. 2-30). This switch allows the pilot, in an emergency condition, to raise or lower the ramp to a partially open, fully open, or fully closed position. The switch is labeled UP, HOLD, and DN (down), and is spring loaded to the center (HOLD) position. The switch is active only when the RAMP PWR switch is set to EMERG. For up operation, the ramp will move only while the momentary switch is held in the UP position, and will stop as soon as the switch is released. For down operation, the switch has a minimum 5 second function which allows the pilot to lower the ramp for 5 seconds by momentarily moving the switch to DN and immediately releasing it. The downward ramp movement will stop 5 seconds after the switch is selected to the DN position (5 second timer circuit). If the ramp and cargo door (ramp tongue) are in the fully closed position, a single momentary selection of the DN position will provide sufficient time for the cargo door to be fully retracted into the ramp. The ramp can be further lowered in 5 second intervals, by momentarily reselecting the DN position when the ramp stops. The downward motion of the ramp may be stopped at any time by momentarily setting the RAMP EMER switch to the UP position. The ramp can also be lowered continuously (for more than 5 seconds) by holding the switch in the DN position until the desired ramp level is achieved.

At the UP or DN position, 28-volt DC activates the respective up or down solenoid on the ramp control



valve. The ramp control valve handle moves to the selected position, and the ramp repositions as selected. At HOLD, electrical power is removed from both the up and down solenoids. The ramp control valve handle moves to the STOP position and the ramp remains locked in position. Power for the switch is supplied by the No. 1 DC essential bus through the RAMP PWR switch and the RAMP EMER CONT circuit breaker on the No. 1 PDP.

**2-102. Hydraulic System Service Module.** A service module, on the right side of the cargo compartment above the ramp, provides for filling the two flight control hydraulic systems and the utility hydraulic system. It consists of a filler assembly, a two-stage hand pump, and a selector valve for selection of any of the three hydraulic systems for tilling.

**2-103. Utility System Hand Pump.** A two-stage hand pump, on the right side of the cargo compartment above the ramp, is used to pressurize the APU start accumulators for APU starting. Also, in conjunction with the EMERG UTIL PRESS controllable check valve, it may be used to operate the ramp and door.

**2-104. EMERG UTIL PRESS Controllable Check Valve.** The EMERG UTIL PRESS controllable check valve is located above the hand pump. It allows APU start accumulator pressure to be used for operation of the ramp or any other subsystem (brakes, swivel locks, etc.). When the APU motor pump or utility pump is not operating, it is not necessary to use the hand pump unless the accumulator is discharged.

When the accumulator is discharged, the EMERG UTIL PRESS controllable check valve in conjunction with the

hand pump may be used to operate the ramp and hatch. The NORMAL position of the check valve is used when the system is pressurized by the APU or by the utility hydraulic pump. When the engines and the APU are not operating, the controllable check valve is set to OPEN, the ramp control handle is set to UP or DN, and the hand pump is operated. When ramp movement is completed, the ramp control handle is set to STOP and the controllable check valve is set to NORMAL. This valve may also be used in flight, in the event of utility pump or system failure to provide accumulator pressure to the subsystems.

**2-105. Hydraulic Pressure Cautions.** Three hydraulic pressure caution capsules, one for each flight control system and one for the utility hydraulic pressure system, are on the master caution panel (fig. 2-51). They are labeled NO. 1 HYD FLT CONTR, NO. 2 HYD FLT CONTR, and UTIL HYD SYS. Each capsule is electrically connected to a pressure switch in the corresponding control module. Whenever hydraulic pressure drops **below 1,800** psi in one of the flight control systems or the utility system, that system caution illuminates. The caution capsule extinguishes as increasing pressure **approaches 2,300** psi. Caution capsule operation is independent of hydraulic pressure indicator operation. Power for these capsules is supplied by the DC essential bus through the CAUTION PNL circuit breaker on NO. 1 PDP.

**2-106. Hydraulic Pressure Indicators.** Three HYDRAULICS PRESSURE indicators (fig. 2-34), one for each hydraulic system, are on the MAINTENANCE PANEL. Refer to Section IX Utility Systems.

## SECTION VII POWER TRAIN SYSTEM

### 2-107. General.

Engine power is supplied to the rotors through a mechanical transmission system (fig. 2-1). This system consists of a forward, a combining (mix), an aft, two engine transmissions, and drive shafting. An overrunning sprag clutch is installed in each engine transmission. The clutch provides a positive drive connection to transmit power and permits freewheeling of both rotors when in an actual autorotation or during a simulated power failure. Because of the freewheeling feature, no drag will be placed on the rotors if an engine (or engines) fails.

Power from the engine transmissions is transmitted through separate drive shafts to the combining (mix) transmission. The combining (mix) transmission combines the power of the engines and transmits it at reduced shaft speed to the forward and aft transmissions. Further speed reduction occurs within the rotor transmission.

Two AC generators, the No. 2 flight control hydraulic pump, and the utility system pump are mounted on and driven by the aft transmission. The No. 1 flight control hydraulic pump is mounted on and driven by the forward transmission.

### 2-108. Transmission Lubrication Systems.

The forward, aft, and combining (mix) transmissions have independent main and auxiliary lubrication systems which operate concurrently. Each transmission has a filter with an impending bypass indicator. If the differential pressure across the filter exceeds **15 to 18** psi, the bypass indicator will extend to indicate a partially clogged filter. When the differential pressure reaches **25 to 30** psi, lubrication oil will bypass the filter. Refer to table 2-3 for transmission oil system capacities, oil specifications, and servicing procedures.

**2-109. Forward Transmission.** The forward transmission lubrication system supplies lubricating oil to the gears and bearings in the forward transmission. Main system oil flows from the sump, through the main oil pump, oil filter, cooler, and a jet protection screen to jets from which the oil is discharged to the various gears and bearings. Auxiliary system oil flows from the auxiliary sump through the auxiliary oil pump, and the auxiliary system filter to separate auxiliary oil jets. An oil cooler mounted on the aft end of the transmission around the input pinion cools main system oil. Air is forced through the cooler by a transmission-driven fan.

**2-110. Aft Transmission.** The aft transmission lubrication system supplies lubricating oil to the various gears and bearings in the aft transmission and to the aft rotor shaft bearing. In addition, the main lubrication system circulates cooling oil through the two AC generators on the aft transmission. Transmission oil flows

from the sump through the main lube pump, main filter, cooler, and the jet protection screen to jets where the oil is sprayed onto the various gears and bearings. In addition, after the oil leaves the jet protection screen, alternate paths route some of the lubricating oil to the aft shaft bearing and cooling oil to the generators. Auxiliary system oil flows from the auxiliary sump through the auxiliary pump and filter to the various gears and bearings. Separate oil jets are utilized for each oil system. The auxiliary system does not lubricate the aft shaft bearing or the generators. An oil cooler mounted on the aft end of the transmission cools main system oil. Cooling air is drawn through the cooler by a transmission-driven fan.

**2-111. Combining and Engine Transmission Lubrication Systems.** The combining (mix) transmission contains the oil reservoirs to supply lubrication oil to the various gears and bearings in the combining (mix) transmission, No. 1 engine transmission, and the No. 2 engine transmission. Two lubricating pumps with four elements each are within the combining (mix) transmission: left pump assembly and right pump assembly. The left pump assembly provides main lubrication to the combining (mix) transmission and the No. 1 engine transmission. The right pump assembly provides auxiliary lubrication to the combining (mix) transmission and lubricates the No. 2 engine transmission. Each pump assembly contains two pumping elements and two scavenge elements.

Combining transmission main lubrication oil flows from the combining (mix) transmission oil reservoir through the left pump assembly, filter, cooler, jet protection screen, and to the jets which spray the oil onto the various gears and bearings. One of the scavenge elements of the left pump assembly returns the oil from the combining (mix) transmission sump to the combining (mix) transmission oil reservoir. The auxiliary lubrication oil flows from the combining (mix) transmission auxiliary oil reservoir to the right pump assembly, auxiliary lubrication filter, and to the jets which spray the oil on to the various gears and bearings. One of the scavenge elements of the right pump assembly returns the oil from the combining (mix) transmission sump to the combining (mix) transmission oil reservoir. The right pump assembly does not route oil through a cooler.

No. 1 engine transmission oil flows from the No. 1 engine transmission oil reservoir on the combining (mix) transmission through the left pump assembly, filter, cooler, jet protection screen, and to the jets which spray the oil onto the various gears and bearings. One of the scavenge elements of the left pump assembly returns the oil from the No. 1 engine transmission sump through a debris indicating screen and back to the No. 1 engine transmission oil reservoir. No. 2 engine transmission oil flows from the No. 2 engine transmission oil reservoir

on the combining (mix) transmission through the right pump assembly, filter, cooler, jet protection screen, and to the jets which spray the oil onto the various gears and bearings. One of the scavenge elements of the right pump assembly returns the oil from the No. 2 engine transmission sump through a debris indicating screen and back to the No. 2 engine transmission oil reservoir. Engine transmissions do not have auxiliary lubrication systems.

All No. 1 and No. 2 engine transmission lubrication system components are on the combining (mix) transmission except the jet protection screens and jets. Separate oil jets are utilized for each transmission lubrication oil system. The individual oil coolers for the combining (mix) and both engine transmissions are mounted on the combining (mix) transmission and utilize a common transmission driven fan for cooling air.

**2-112. Transmission Main Oil Pressure Indicator.**

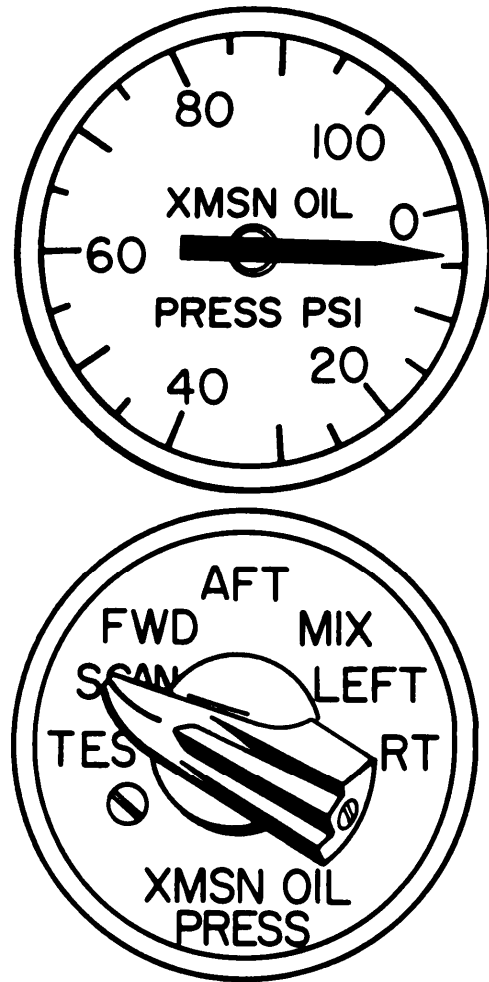
A transmission main oil pressure indicator is located on the center instrument panel (fig. 2-31). It indicates either the lowest main oil pressure in any one of the transmissions or only the oil pressure in the transmission selected by the pilot. The indicator is electrically connected to each transmission. In addition, each transmission and the aft rotor shaft bearing has a separate low pressure switch. These switches are connected to the XMSN OIL PRESS caution capsule on the master caution panel and the TRANSMISSION MAIN OIL PRESS indicating lights on the MAINTENANCE PANEL (fig. 2-34). Power to operate the indicator is supplied by the No. 1 AC bus through the XMSN OIL PRESS circuit breaker on the No. 1 PDP.

**2-113. Transmission Main Oil Pressure Selector**

**Switch.** A transmission oil pressure selector switch is located on the center instrument panel (fig. 2-31). The switch positions are labeled TEST, SCAN, FWD, AFT, MIX, LEFT, and RT. When the switch is set to TEST, the pointer on the transmission pressure indicator will drop to zero or below. When the switch is set to SCAN, the lowest main oil pressure among all the transmission will be indicated. The remaining positions are used to select a particular transmission oil pressure indication. When selecting a particular switch position, be sure the switch is in detent. If the switch is not in detent, the pressure gage will indicate zero.

**2-114. Transmission Main Oil Temperature Indicator.**

A transmission oil temperature indicator is located on the center instrument panel (fig. 2-32). It reads from  $-70^{\circ}$  to  $+150^{\circ}\text{C}$ . It indicates the highest oil temperature among all the transmissions or only the oil temperature of the selected transmission. A temperature probe is located in the forward and aft transmission sumps and in each compartment of a three-compartment oil tank for the combining (mix) transmission and in each engine transmission. The temperature probes in the three tank compartments measure oil temperature in the tank and may not immediately indicate a transmission problem. Loss of oil or low oil pressure may not be accompanied by a high oil temperature indication.



NOTE:  
REFER TO CHAPTER 5 FOR INSTRUMENT MARKINGS.

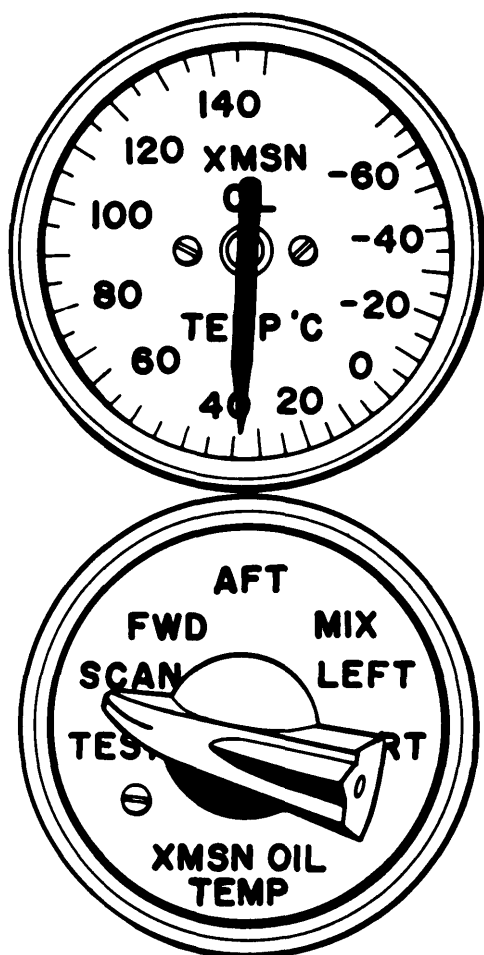
D145-81-10

**Figure 2-31. Transmission Main Oil Pressure Indicator and Selector Switch**

Each temperature probe incorporates a high oil temperature switch which is independent of the temperature indicator and is triggered at  $140^{\circ}\text{C}$ , lighting the XMSN OIL HOT caution capsule on the master caution panel and to the TRANSMISSION OVERTEMP magnetic indicators on the MAINTENANCE PANEL. Power to operate the indicator is supplied by the No. 1 AC bus through the XMSN OIL TEMP circuit breaker on the No. 1 PDP.

**2-115. Transmission Main Oil Temperature Selector**

**Switch.** A transmission oil temperature selector switch is on the center instrument panel below the transmission oil temperature indicator (fig. 2-32). The switch positions are labeled TEST, SCAN, FWD, AFT, MIX, LEFT, and RT. When the switch is set to TEST, the pointer on the transmission oil temperature indicator deflects full scale toward low temperature. When the switch is set to SCAN, the highest oil temperature among all transmissions is indicated. The remaining positions are used for selecting a particular transmission



NOTE: REFER TO CHAPTER 5 FOR INSTRUMENT MARKING.  
D145-82-10

**Figure 2-32. Transmission Main Oil Temperature Switch and Indicator**

oil temperature indication. When selecting a particular switch position, be sure the switch is in detent. If the switch is not in detent, the oil temperature indicator will indicate  $-70^{\circ}\text{C}$ .

**2-116. Transmission Oil Cautions.** Five transmission oil caution capsules are on the master caution panel. The capsules are labeled XMSN OIL HOT, XMSN OIL PRESS, XMSN AUX OIL PRESS, and NO. 1 AND NO. 2 ENG XMSN HOT. These cautions, in conjunction with the transmission oil pressure and temperature indicators on the center instrument panel and the TRANSMISSION OVERTEMP magnetic indicators, MAIN OIL PRESS, and AUX OIL PRESS indicating lights on the MAINTENANCE PANEL, alert the crew to impending transmission lubrication problems. The cautions operate independently of the pressure and temperature indicators on the center instrument panel.

a. *XMSN OIL HOT Caution.* It illuminates when the main oil temperature in the sump of the forward, aft, and reservoir of the combining (mix) or either engine transmission **exceeds**  $140^{\circ}\text{C}$ . The hot transmission is identified by the oil temperature selector switch

and indicator and the TRANSMISSION OVERTEMP magnetic indicators on the MAINTENANCE PANEL.

b. *XMSN OIL PRESS Caution.* It illuminates when main oil pressure drops **below 20** psi in any transmission or aft rotor shaft pressure drops **below 10** psi. The low-pressure system is identified by the transmission oil pressure selector switch and indicator on the center instrument panel and the TRANSMISSION MAIN OIL PRESS indicating lights on the MAINTENANCE PANEL. If the XMSN OIL PRESS caution capsule illuminates and the affected transmission cannot be determined using the selector switch, the condition may be caused by loss of aft rotor shaft oil pressure. Low oil pressure at the aft rotor shaft is indicated by the illumination of the TRANSMISSION AFT SHAFT MAIN OIL PRESS indicating light on the MAINTENANCE PANEL.

c. *XMSN AUX OIL PRESS Caution.* It is activated by individual aux oil switches and illuminates when auxiliary oil pressure drops **below 20** psi in the fwd or aft transmission and **10** psi in the combining (mix) transmission. The transmission with the low pressure is identified by a lit TRANSMISSION AUX OIL PRESS indicating light on the MAINTENANCE PANEL.

d. *NO. 1 or NO. 2 ENG XMSN HOT Caution.* They illuminate if oil temperature in either engine transmission **exceeds** about  $190^{\circ}\text{C}$ . The capsules are activated by a thermostich in each engine transmission. The thermostich monitors oil temperature in the transmission, not in the reservoir. It is part of a chip detector and temperature assembly in each engine transmission.

**2-117. Transmission Chip Detectors.** Chip detectors are installed in all transmission and aft rotor shaft thrust bearing lubrication systems. All transmission chip detectors, except those in the engine transmission, are connected to the XMSN CHIP DET caution capsule on the master caution panel. Engine transmission chip detectors are connected to the corresponding NO. 1 or NO. 2 ENG CHIP DET caution capsules.

All transmissions and the aft rotor shaft chip detectors are also connected to the TRANSMISSION CHIP DETECTOR magnetic indicators on the MAINTENANCE PANEL. When a chip detector is bridged by ferrous particles, the XMSN CHIP DET, or the NO. 1 and/or NO. 2 ENG CHIP DET caution capsule illuminates. At the same time, the corresponding TRANSMISSION CHIP DETECTOR indicator on the MAINTENANCE PANEL will trip and change from an all-black indication to a black-and-white indication, identifying the transmission.

**2-118. Transmission Chip Detectors Fuzz Burn-Off.** Helicopters equipped with the chip detector fuzz bum-off system in the forward, combining (mix), aft, No. 1 and No. 2 engine transmission, and aft rotor shaft thrust bearing are identified by a module labeled PWR MDL CHIP BURN-OFF located below the MAINTENANCE PANEL. The chip detector fuzz burn-off system employs an automatically operated fuzz bum-off electrical circuit with the ability to eliminate nuisance

**TM 55-1520-240-10**

chip lights caused by minute ferrous metallic fuzz or ferrous metallic particles on the transmission chip detectors. The response time of the fuzz bum-off circuit is more rapid than that of the helicopter warning system; thus a successful fuzz burn-off will be accomplished before any caution capsule on the master caution panel illuminates. Should the particle or particles not burn off,

the XMSN CHIP DET caution will illuminate. Also, the corresponding TRANSMISSION CHIP DETECTOR or ENGINE CHIP DETECTOR magnetic indicator on the MAINTENANCE PANEL will latch. Power for the PWR MDL CHIP BURN-OFF is supplied by the No. 1 DC bus through the HYDRAULICS MAINT PNL circuit breaker on the No. 1 PDP.

## SECTION VIII ROTOR SYSTEM

### 2-119. General.

Lift is produced by a rotor system consisting of two fully articulated counter-rotating rotors. Each rotor has three fiberglass blades. The forward rotor is driven by the forward transmission through a rotor drive shaft. The aft rotor is driven by the aft transmission through a vertical drive shaft.

The rotor head consists of a hub connected to three pitch-varying shafts by three horizontal hinge pins. These pins permit blade flapping. Stops on the top and the bottom of the hub limit the blade flapping motion. The aft rotor head is equipped with centrifugal droop stops which provide increased blade flapping angle for ground and flight operation.

Covers may be installed on the centrifugal droop stop operating mechanism. The covers prevent ice accumulation on the mechanism and ensure proper droop stop operation following flight in icing conditions. For information on use of the droop stop covers, refer to Chapter 8, Section IV.

Mounted coaxially over the pitch-varying shafts are pitch-varying housings to which the blades are attached by vertical hinge pins. These pins permit blade leading and lagging. Each pitch-varying shaft is connected to the pitch-varying housing by a laminated tie bar assembly. The high tensile strength and low torsional stiffness of the tie bar retains the blade against centrifugal force and allows blade pitch changes about the pitch axis.

Blade pitch changes are accomplished by three pitch-varying links connected from the rotating ring of the swashplate to the pitch-varying housing on each rotor blade. Cyclic pitch changes are accomplished by tilting the swashplate. Collective pitch changes are accomplished by vertical movement of the swashplate. Combined collective and cyclic pitch changes result from combined control inputs by the pilot.

A direct-action shock absorber is attached to the blade and to the pitch-varying housing. When the inboard end

of the shock absorber is disconnected, the blade can be folded in either direction about the vertical hinge pin.

### 2-120. Rotor Blades.

a. Each rotor blade consists of a D-shaped fiberglass spar assembly and a Nomex fairing assembly bonded to the spar. The blade chord is **32** inches.

b. A titanium nose cap is bonded to the leading edge of the spar. A nickel erosion cap is bonded to the blade along the outer **54** inches of leading edge. This cap protects the part of the blade most vulnerable to erosion.

c. The fairing assembly is bonded to the trailing edge of the spar. These fairings are constructed of a Nomex honeycomb core covered with a fiberglass skin. Wire mesh screens are embedded in the fiberglass skin at the tip and the trim tab. The wire mesh screens provide an electrical path to the rotor hub from the metal trim tab and tip for lightning protection. Also, to provide lightning protection, each blade has two lightning protection cables and two straps. The cables and straps complete the path from the wire mesh to the rotor head.

d. Balance and tracking weights are installed in the tip of spar and fairing assembly. The tracking weights are removable and are used for blade track and balance.

### 2-121. Rotor Tachometers.

Two rotor tachometers (16, fig. 2-8 and fig. 2-10), one mounted on the pilot instrument panel, the other mounted on the copilot instrument, indicate percent of rotor revolutions per minute (RRPM). A small needle on the tachometer indicates percent RPM from **0** to **60**. The large needle indicates percent RPM from **60** to **130**. The RRPM sense signal is supplied by the AC generators. Generator No. 1 supplies the copilot indicator and generator No. 2 supplies the pilot indicator. Power to operate the indicators is supplied by the DC essential bus through the ROTOR TACH circuit breaker on the No. 1 and No. 2 PDP.

## SECTION IX UTILITY SYSTEMS

## 2-122. Anti-icing Systems.

Anti-icing is provided for the pitot tubes, AFCS yaw ports, and windshields.

## 2-123. ANTI ICE Panel.

The ANTI ICE panel is located on the overhead switch panel (fig. 2-33). It has three two-position W/S (windshield) switches labeled CPLT, CTR, and PLT. The switches positions are OFF and ON. In addition, a two-position PITOT heat switch is in this panel. The switch positions are OFF and ON.

Power for the pilot and center windshields is from the No. 2 AC bus through the WSHLD ANTI ICE HEAT PILOT and CTR circuit breakers. Power for the copilot windshield is from the No. 1 AC bus through the WSHLD COPLT HEAT circuit breaker on the No. 1 PDP. Anti-ice control for the pilot and center windshield is from the 28-volt No. 2 DC bus through the WSHLD ANTI ICE CONT CTR and PILOT circuit breakers on the No. 2 PDP. Anti-ice control for the copilot windshield is from the 28-volt No. 1 DC bus through the WSHLD COPLT CONT circuit breaker on the No. 1 PDP. Power to operate the heater elements in the pitot tubes and yaw ports is supplied by the No. 2 AC bus through the PITOT HEAT and YAW PORT HEAT circuit breakers on the No. 2 PDP.

a. *W/S Switches.* The pilot and copilot windshields are anti-iced and defogged electrically. The center windshield is defogged but not anti-iced. The laminated windshield panels are heated electrically by current which passes through a transparent conductive coating embedded between the layers.

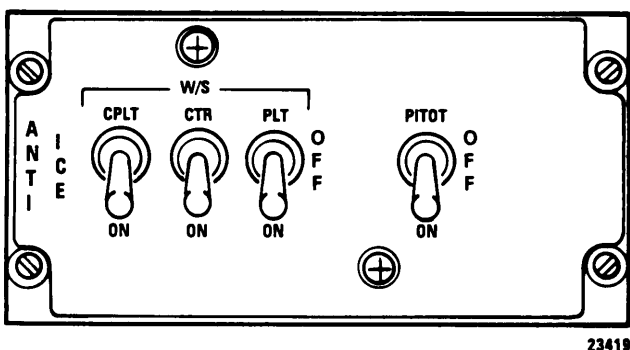


Figure 2-33. Anti Ice Panel

**CAUTION**

**If windshield bubbling or delamination occurs around the sensor element, immediately place switch to OFF for that windshield.**

When any switch is moved to ON, current flows to the associated temperature controller and then to the windshield. As the temperature of the windshield rises to a preset value (**about 44°C**), as sensed by the sensor element, the electrical current to the windshield is interrupted by the temperature control relay. Once the windshield has cooled sufficiently, electrical current is reapplied. This causes a cycling effect which maintains windshield temperature within operating limits.

Operating temperature is reached in **less than 1** minute after the switch is placed to ON. When the switch is placed to OFF, the anti-icing system is deenergized.

b. *PITOT Heat Switch.* Heating elements prevent ice accumulation in the pitot tubes and the yaw ports. When the PITOT switch is placed to ON, power to the heater elements in the pitot tubes and yaw ports is applied. When the switch is placed to OFF, the heating elements are deenergized.

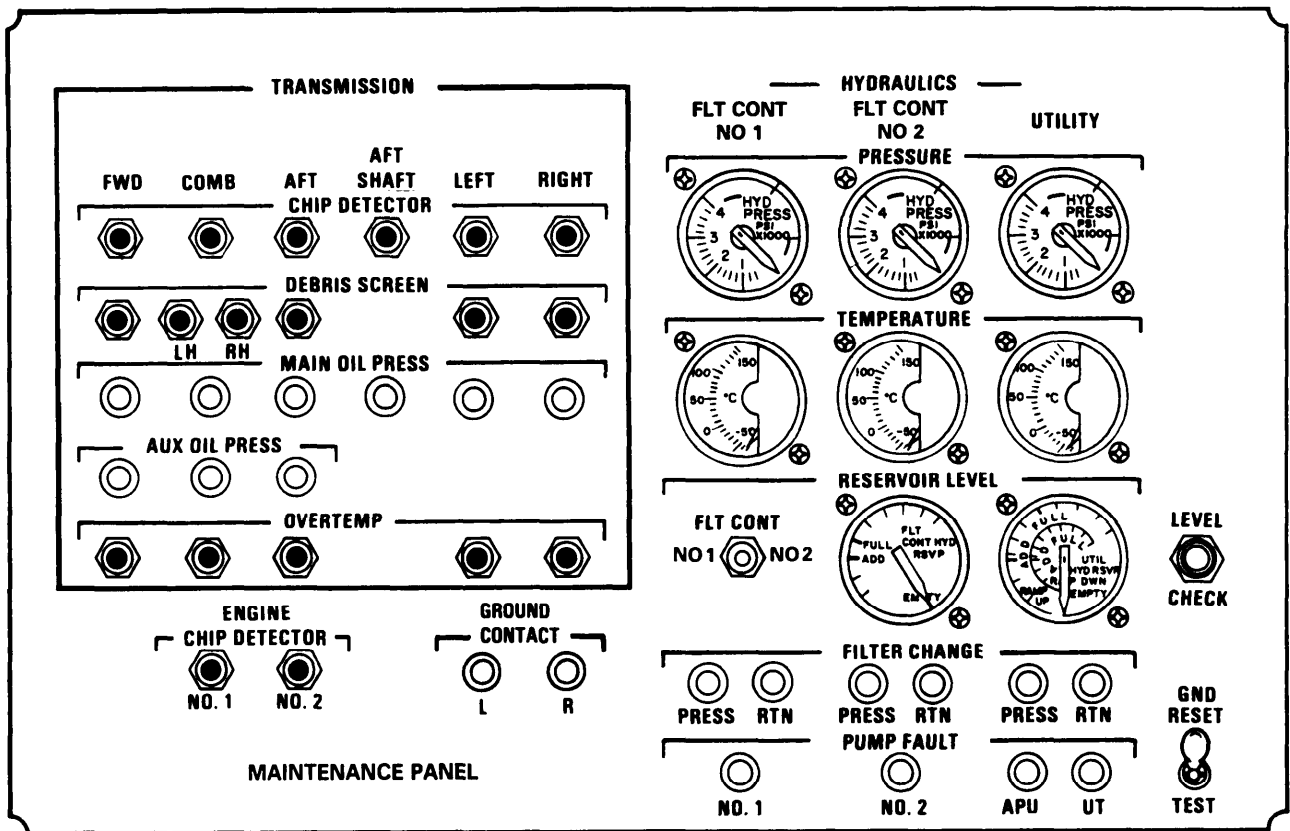
## 2-124. MAINTENANCE PANEL.

The MAINTENANCE PANEL is on the right side of the cabin above the ramp (fig. 2-34). The panel is provided to assist in the identification of system malfunction or condition that may require servicing or other maintenance. The panel is divided into four sections. They are labeled TRANSMISSION, HYDRAULICS, ENGINE, and GROUND CONTACT.

**2-125. TRANSMISSION Section.** This section monitors the FWD, COMB, AFT, AFT SHAFT, LEFT, and RIGHT transmissions. It consists of six CHIP DETECTOR magnetic indicators, six DEBRIS SCREEN magnetic indicators, six MAIN OIL PRESS indicating PRESS-TO-TEST lights, three AUX OIL PRESS indicating PRESS-TO-TEST lights, and five OVERTEMP magnetic indicators. Power to operate the indicators is supplied by the No. 1 DC bus through the HYDRAULICS MAINT PNL circuit breaker on the No. 1 PDP.

a. *CHIP DETECTOR Magnetic Indicators.* When the corresponding CHIP DETECTOR is bridged by ferrous particles, the associated chip detector indicator changes from all-black to black-and-white. In addition, the XMSN CHIP DET or ENG CHIP DET caution capsule illuminates on the master caution panel.

b. *DEBRIS SCREEN Magnetic Indicators.* There is one indicator each for the FWD transmission, AFT transmission, and LEFT and RIGHT engine transmissions. There are two indicators for the COMB transmission. One indicator for the left sump and one indicator for the right sump.



NOTE:  
REFER TO CHAPTER 5 FOR INSTRUMENT LIMIT MARKINGS.

12501

Figure 2-34. Maintenance Panel

**NOTE**

There is no cockpit indication of a latched DEBRIS SCREEN magnetic indicator. If a DEBRIS SCREEN magnetic indicator latches, the flight engineer shall advise the pilot immediately.

The indicators are electrically connected to screens in the sumps of each transmission. If the screen mesh is bridged with conductive particles, the indicating circuit closes and trips the corresponding DEBRIS SCREEN magnetic indicator on the MAINTENANCE PANEL.

c. *MAIN OIL PRESS Indicating Lights.* If main oil pressure drops **below 20** psi in any transmission or 10 psi in the aft shaft bearing, the corresponding indicating light will illuminate. In addition, the XMSN OIL PRESS caution will illuminate on the master caution panel.

d. *AUX OIL PRESS Indicating Lights.* If auxiliary oil pressure drops **below 20** psi in the FWD or AFT transmission or **10** psi in the COMB transmission, the corresponding indicating light will illuminate. In addition, the XMSN AUX OIL PRESS caution will illuminate on the master caution panel.

e. *OVERTEMP Magnetic Indicators.* Each OVERTEMP magnetic indicator is electrically connected to a temperature probe in the reservoir of each transmission. If oil temperature in the transmission reservoir, **exceeds 140°C**, a switch closes. When the switch closes, the

XMSN OIL HOT caution illuminates on the master caution panel and trips the corresponding OVERTEMP magnetic indicator on the MAINTENANCE PANEL, thus identifying the hot transmission.

**2-126. HYDRAULICS Section.** This section monitors the FLT CONT NO 1, FLT CONT NO 2, and UTILITY hydraulic systems. It consists of three PRESSURE indicators, three fluid TEMPERATURE indicators, two RESERVOIR LEVEL indicators, six FILTER CHANGE indicating PRESS-TO-TEST lights, and four PUMP FAULT indicating PRESS-TO-TEST lights. Power to operate the indicators is supplied by the No. 2 DC bus through the HYDRAULICS MAINT PNL LTS circuit breaker on the No. 2 PDP.

a. *PRESSURE Indicators.* The FLT CONT NO 1 and NO 2 PRESSURE indicators are electrically connected to a corresponding pressure transmitter on the respective power control module. The UTILITY PRESSURE indicator is electrically connected to a pressure transmitter on the pressure control module. Indicator operation is independent of caution capsule operation. Power to operate the indicators is supplied by the No. 2 DC bus through the HYDRAULICS PRESS IND circuit breaker on the No. 2 PDP.

b. *TEMPERATURE Indicators.* The indicators are below the PRESSURE indicators. They indicate the temperature of the hydraulic fluid at the outlet of the corresponding reservoir-cooler. Power to operate the



indicators is supplied by the No. 2 DC bus through the HYDRAULICS FLUID TEMP circuit breaker on the No. 2 PDP.

c. RESERVOIR LEVEL Indicators. The left indicator is dedicated to the No. 1 and No. 2 flight control hydraulics system. In addition, a two-position FLT CONT switch labeled NO 1 and NO 2 is used to select the system of which the fluid level is to be indicated. The reservoir should be serviced to the FULL mark before flight. The right indicator is dedicated to the utility hydraulic system. When the pushbutton LEVEL CHECK switch is pressed, the fluid level in each reservoir-cooler will be indicated by the appropriate indicator.

d. FILTER CHANGE indicating Lights. The indicating lights are arranged in three sets of two for each hydraulic system. Each set of indicating lights are labeled PRESS and RTN. The PRESS indicating light in each set monitors the pressure line filter in each system. The RTN indicating light monitors the return line filter in each system. When the pressure drop across a filter **exceeds 75** psi, indicating impending filter bypass, the corresponding filter-change indicating light will illuminate. Power to operate the filter change indicating lights is supplied by the No. 2 DC bus through the HYDRAULICS MAINT PNL LTS circuit breaker on the No. 2 PDP.

e. PUMP FAULT Indicating Lights. The indicating lights are labeled NO. 1, NO. 2, APU, and UT. They are connected to sensors in the case drain line of each pump. If the flow rate from the case drain of a pump increases to the point which causes an increased pressure drop across the sensor, the sensor turns on the corresponding PUMP FAULT light (a high flow rate from the case drain of a pump may indicate impending pump failure). Power to operate the lights is supplied by the No. 1 DC bus through the HYDRAULICS MAINT PNL circuit breaker on the No. 1 PDP.

**2-127. ENGINE CHIP DETECTOR Section.** This section consists of two magnetic indicators labeled NO. 1 and NO. 2. When the corresponding ENGINE CHIP DETECTOR is bridged by ferrous particles, the associated chip detector indicator changes from all-black to black-and-white. In addition, the ENG CHIP DET caution will illuminate on the master caution panel.

**2-128. GROUND CONTACT Section.**

**CAUTION**

**Should either or both GROUND CONTACT indicating lights remain illuminated after lift-off to hover, the indicated system(s) DASH will not function properly in forward flight. If both GROUND CONTACT indicating lights remain illuminated after lift-off, the AUTO function of both cyclic trims system will be inoperative.**

This section consists of two indicating lights labeled L and R. When the landing gear proximity switch is activated, the appropriate GROUND CONTACT indicating light will illuminate.

**2-129. GND Switch.**

**NOTE**

While in flight, the flight engineer shall alert the pilot when placing the GND switch on the MAINTENANCE PANEL to TEST. Placing the switch to TEST will cause the NO. 1 and NO. 2 ENG CHIP DET, XMSN OIL HOT, and XMSN CHIP DET cautions to illuminate.

The GND switch allows the flight engineer to perform a BITE (Built In Test Equipment) test on the circuitry of the MAINTENANCE PANEL. The switch is springloaded and locked at center-off position. At TEST, a black and white display appears on all magnetic BITE indicators. At RESET, all magnetic BITE revert to an all-black indication. Power is supplied to the switch by the No. 1 DC bus through the HYDRAULICS MAINT PNL circuit breaker No. 1 PDP.

**2-130. Windshield Wipers.**

**CAUTION**

**To prevent windshield damage, do not operate windshield wipers when windshields are dry.**

Two electrically driven windshield wipers 3, fig. 2-4) are installed, one on each pilot windshield. One motor operates both wipers through two flexible shafts and two windshield wipers converters. The windshield wiper motor is controlled by the W/S (windshield) WIPER switch located on the overhead switch panel. Power is supplied by the No 2 DC bus through the WSHLD WIPER circuit breaker on the No. 2 PDP.

The W/S WIPER switch has five positions labeled OFF, SLOW, MED, FAST, and PARK. Wiper speed can be adjusted as desired, by rotating the switch from OFF. At OFF the wipers will stop immediately at any position on the arc of travel. At PARK, the wipers stop and reposition against the inside windshield frame.

**2-131. Map and Data Case.**

The map and data case is in the passageway. It holds manuals, maps, and other data.

**2-132. Cockpit Rearview Mirror.**

A rearview mirror is installed on the right center windshield support to enable the pilot to observe the cargo compartment

**2-133. Spare Lamp Stowage Box.**

The spare lamp stowage box is in the cockpit on top of the No. 1 PDP. Spare lamps are provided for the instrument post lights.

instrument light shields, dome lights, cabin and ramp lights, and nacelle work lights.

#### **2-134. Cockpit Utility Receptacles.**

Two 28-volt DC utility receptacles are in the cockpit, one on No. 1 PDP and one on No. 2 PDP. Each receptacle is labeled UTIL RCPT 28V DC. Power to operate the copilot receptacle is supplied by the No. 1 DC bus through the UTILITY COPLT circuit breaker on the No. 1 PDP. Power to operate the pilot receptacle is supplied by the No. 2 DC bus through the UTILITY RCPT PILOT circuit breaker on the No. 2 PDP.

#### **2-135. AC Cabin Utility Receptacles.**

A 115 volt, single-phase 400 Hz AC utility receptacle and a 200 volt 3-phase 400 Hz AC utility receptacle are on each side of the cabin at sta 320. The receptacles are accessible after the acoustical access cover and the receptacle dust cap are removed. Power to operate the 115 volt receptacles is supplied by the No. 1 and No. 2 AC buses through the LH and RH UTIL RCPT circuit breakers on No. 1 and No. 2 PDP. Power to operate the 200 volt receptacles is supplied by the No. 1 and No. 2 AC buses through the LH and RH CABIN AC RCPT 3-phase circuit breakers on No. 1 and No. 2 PDP.

#### **2-136. DC Cabin Utility Receptacles.**

Four 28-volt DC utility receptacles with three outlets are on the sidewalls of the cargo compartment. Power to operate the left cabin utility receptacles is supplied by the No. 1 DC bus through the UTILITY LH FWD and LH AFT circuit breakers on the No. 1 PDP. Power to operate the right cabin utility receptacles is supplied by the No. 2 DC bus through the UTILITY RCPT RH AFT and RH FWD circuit breakers on the No. 2 PDP.

#### **2-137. Ash Trays.**

Three ash trays are installed in the cockpit, one for each pilot and one for the troop commander.

#### **2-136. Compass Correction Card Holder.**

The magnetic compass correction card holder is attached to the left side of the magnetic compass. The card contains the necessary deviation values which are applied to the indicated reading.

#### **2-139. Pilot Assist Straps.**

Two assist straps are attached to the center window frame of the cockpit structure to provide the pilots with a hand hold while getting into the seats. The assist strap can be positioned flat against the structure after use.

**SECTION X HEATING, VENTILATION, COOLING, AND ENVIRONMENTAL CONTROL SYSTEMS**

**2-140. Heating and Ventilating System.**

A 200,000 btu/hr capacity internal combustion heating system is provided. It consists of a heater unit, a fuel control unit, an ignition assembly, a blower, control relays, and air pressure and temperature control circuits. Ducting carries heated air or ventilating air to the cockpit and the cabin. The heater consumes approximately 15 pounds of fuel per hour from the right main fuel tank.

The heater and blower are mounted vertically on the right side of the helicopter, immediately aft of the forward cabin section bulkhead. Air for the system is provided by the blower which draws air from an inlet on the forward upper side of the fuselage. If sufficient air is not available for proper heater operation, an automatic differential pressure switch in the heater circuit will stop the heater.

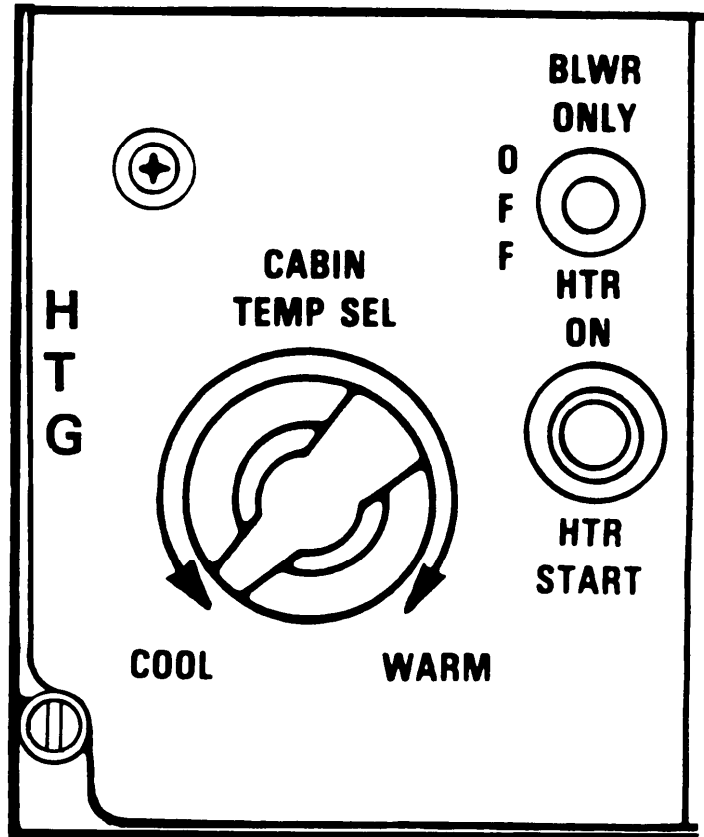
Both ventilating and combustion air enters the heater inlet. The heating air passes over the heated metal walls of the combustion chamber and is directed to a network of ducting. The air entering the combustion chamber is combined with atomized fuel and, after combustion that heats the metal walls, the exhaust is discharged through an outlet on the forward upper side of the fuselage. Power to operate the blower is supplied by the No. 2 AC bus through the CABIN HEATER BLOWER circuit breaker on the No. 2 PDP. Power to the rest of the system is supplied by the No. 2 DC bus through the CABIN HEATER CONT circuit breaker on the No. 2 PDP.

**2-141. HTG Panel.**

The HTG (heating) panel (fig. 2-35) is located on the overhead switch panel (fig. 2-12). It consist of a rheostat-type CABIN TEMP SEL rotary switch, a three-position heater function switch, and a spring-loaded pushbutton HTR START switch.

a. *CABIN TEMP SEL Rotary Switch.* The CABIN TEMP SEL rotary switch is labeled COOL and WARM. This switch operates in conjunction with the temperature controller relay in the heater circuit and with a cabin thermostat. One set of contacts on the temperature controller relay closes to complete a circuit to the fuel control solenoid valve. This allows fuel to be delivered to the heater.

The second set of contacts on the temperature controller relay closes to complete the circuit to the heater windings in the cabin thermostat. The heater windings heat a column of mercury in the thermostat, causing it to rise. When the mercury column reaches a 34°C contact, the temperature control relay is shunted, causing its contacts to open and interrupt the circuit to the fuel control solenoid valve. This stops heater operation by shutting off the fuel supply to the heater.



24173

**Figure 2-35. HTG Panel**

The circuit to the thermostat heater winding is also interrupted, allowing the winding to cool and the mercury column to contract, thus reenergizing the temperature controller relay. This creates a cycling effect, the rate of which can be varied by increasing or decreasing the resistance between the temperature selector and the thermostat heating winding. Resistance is varied by turning the CABIN TEMP SEL rotary switch. This increase or decrease in resistance directly varies the time the heater is allowed to operate before being automatically cycled.

b. *Heater Function Switch.* The heater function switch is labeled BLWR ONLY, OFF, and HTR ON. The switch selects the desired feature of the heating and ventilating system. When the switch is set to BLWR ONLY, the blower forces unheated air into both the cockpit and cabin. Further movement of the heater controls is not required. Selecting HTR ON energizes the various units of the heater once the HTR START

switch is pressed. The heating and ventilating system is shut down when the switch is set to OFF.

*c. HTR START Switch.* When HTR ON is selected on the heater function switch and the HTR START switch is pressed, the heater control circuits are energized. The blower starts and purges the heater combustion chamber of any unburned fuel, while the remainder of the circuit remains inactive because of a **10 to 15** second time-delay relay. After the time-delay relay is energized, the ignition assembly is powered and the master fuel solenoid valve opens, allowing fuel to flow to the heater fuel control unit to complete the start.

#### **2-142. Cockpit Air Knob.**

Two cockpit air knobs (15, fig. 2-8 and 9, fig. 2-10) are on the lower outboard corner of both the pilot and the copilot instrument panels. The knobs are labeled PULL FOR COCKPIT AIR. Each knob controls a valve on the heater ducting which regulates the airflow to the cockpit.

#### **2-143. Air Control Handles.**

Two air control handles are mounted through a placard on the right side of the canted console. The placard is labeled AIR CONTROL PULL FOR ON with each handle labeled COCKPIT DEFOG OR DEFROST and CABIN AIR. By pulling the DEFOG OR DEFROST handle, heater or ventilating air is directed to the cockpit nose enclosure ducting. The airflow is directed to the transparent portion of the jettisonable doors and nose enclosure providing defrosting as well as additional

forward cockpit section heating. When the CABIN AIR handle is pulled, heated or ventilating air flows through the ducting to the cabin.

#### **2-144. Cabin Heat Controls.**

Fourteen manually adjustable outlets are provided in the cabin for the comfort of the passengers.

#### **2-145. Heater Caution.**

##### **NOTE**

Since the HEATER HOT caution will not extinguish until the temperature in the combustion chamber is **below 177°C**, it may take several attempts at restarting the heater before the HEATER HOT caution extinguishes.

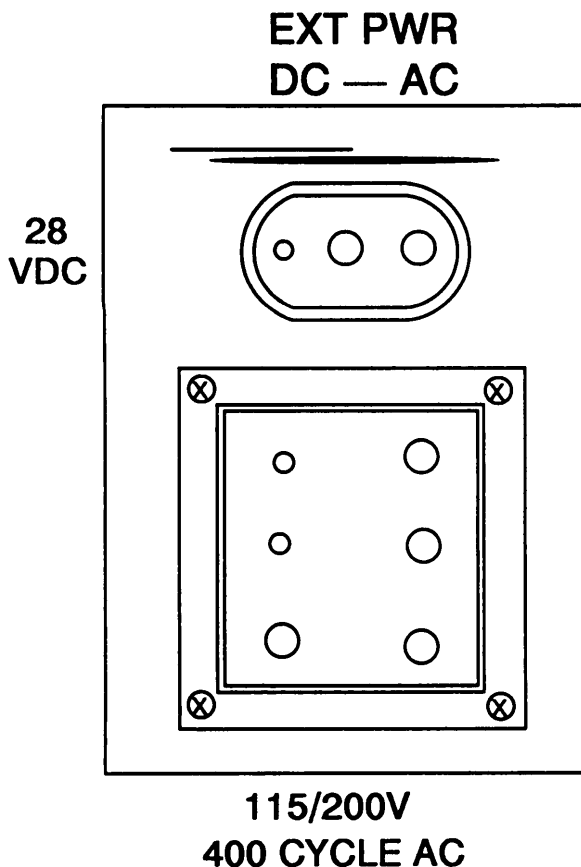
A heater caution capsule labeled HEATER HOT is on the master caution panel (fig. 2-51). This caution indicates failure of the automatic temperature control circuit. If air temperature in the heater **rises to 177°C**, an overheat switch deenergizes the automatic temperature controller relay, shuts off the heating system, except the blower, and activates the HEATER HOT caution. The heating system will not operate until the blower has lowered the heater temperature to normal and the HTR START switch is pressed. Even though the temperature in the combustion chamber has lowered, the HEATER HOT caution will not extinguish until the HTR START switch is pressed.

**SECTION XI ELECTRICAL POWER SUPPLY AND DISTRIBUTION SYSTEMS**

**2-146. Electrical Power Supply System.**

Alternating current (AC) is the primary source of power to operate the electrical and electronic equipment. Three AC generators, two driven by the aft transmission and one driven by the APU, produce 115/200-volt 3-phase 400-Hz power. The system develops 28-volt DC through two transformer rectifiers (RECT) one each in the forward section of the left and right fuselage pods. DC is also supplied by a 24-volt nickel-cadmium battery.

Both 115/200-volt 3-phase AC and 28-volt DC can be supplied by operating the APU or by connecting an AC external power source to the external power receptacles (fig. 2-36). If the APU is running or AC external power is connected, DC power is supplied by the helicopter transformer rectifiers (RECT). If only DC external power is supplied, AC power is not available on the helicopter. Circuits are protected by circuit breakers (fig. 2-37). The electrical load is divided between the two AC generators (fig. 2-38). Should one generator fail, the other will automatically take over the entire load. When the APU is running, its single generator powers the entire load.



**Figure 2-36. External Power Receptacles**

**2-147. AC System.**

The AC system supplies 115/200-volt three-phase 400-Hz power from No. 1 AC generator to No. 1 three-phase AC bus and from No. 2 AC generator to the No. 2 three-phase AC bus (fig. 2-38). The AC equipment is powered by these buses. Some of the equipment is operated by 115-volt single-phase AC and some equipment by 26-volt AC power supplied through the transformers.

The AC system is protected from overvoltage, undervoltage, and underfrequency conditions by generator control units. The generators will be disconnected from the AC buses any time the RRPM **drops below 82 to 85 percent for more than 3 to 7 seconds**. The AC power distribution system has four power sources, a contactor control circuit, an AC power transfer circuit, and two AC buses.

The No. 1 and No. 2 generator power sources are two main generators driven directly by the aft transmission. The APU generator is driven directly by the APU. The external power source is an AC power supply connected to the helicopter.

No. 1 and No. 2 generators feed their respective buses. If No. 1 or No. 2 generator fails (or are shut down), the failed generator is isolated from its bus and the operating generator feeds both buses. When No. 1 or No. 2 or both generators are operating, APU generator and external power are blocked from the AC buses.

When the APU generator is operating and the main generators are shut down (or rotors turning **below about 84%**) or switched off, the APU generator feeds both buses. When the APU generator is operating, external power is blocked from the AC buses. When external power is applied to the helicopter (GEN APU, GEN 1, and GEN 2 are OFF), the external power source feeds both buses.

The generator control unit (GCU) also provides generator feeder fault protection. If a fault occurs between the feeder and the airframe, the GCU will disable the generators. This prevents structural damage to the airframe when a ground fault occurs.

The permanent magnet generator (PMG) section within the generator is used to power the main contractors (relays) in the distribution system. A pickoff coil within the PMG provides an RPM signal for the rotor tachometer indicators. This tachometer signal is available whenever the rotors are turning.

**2-148. Generator Control Switches.** The generator control switches are located on the ELEC panel of the overhead switch panel (fig. 2-39). The three switches are labeled GEN 1, GEN 2, and GEN APU. The switch positions are TEST, OFF RESET, and ON.

When the switches are ON, the respective main relay operates, which energizes and connects the generator to

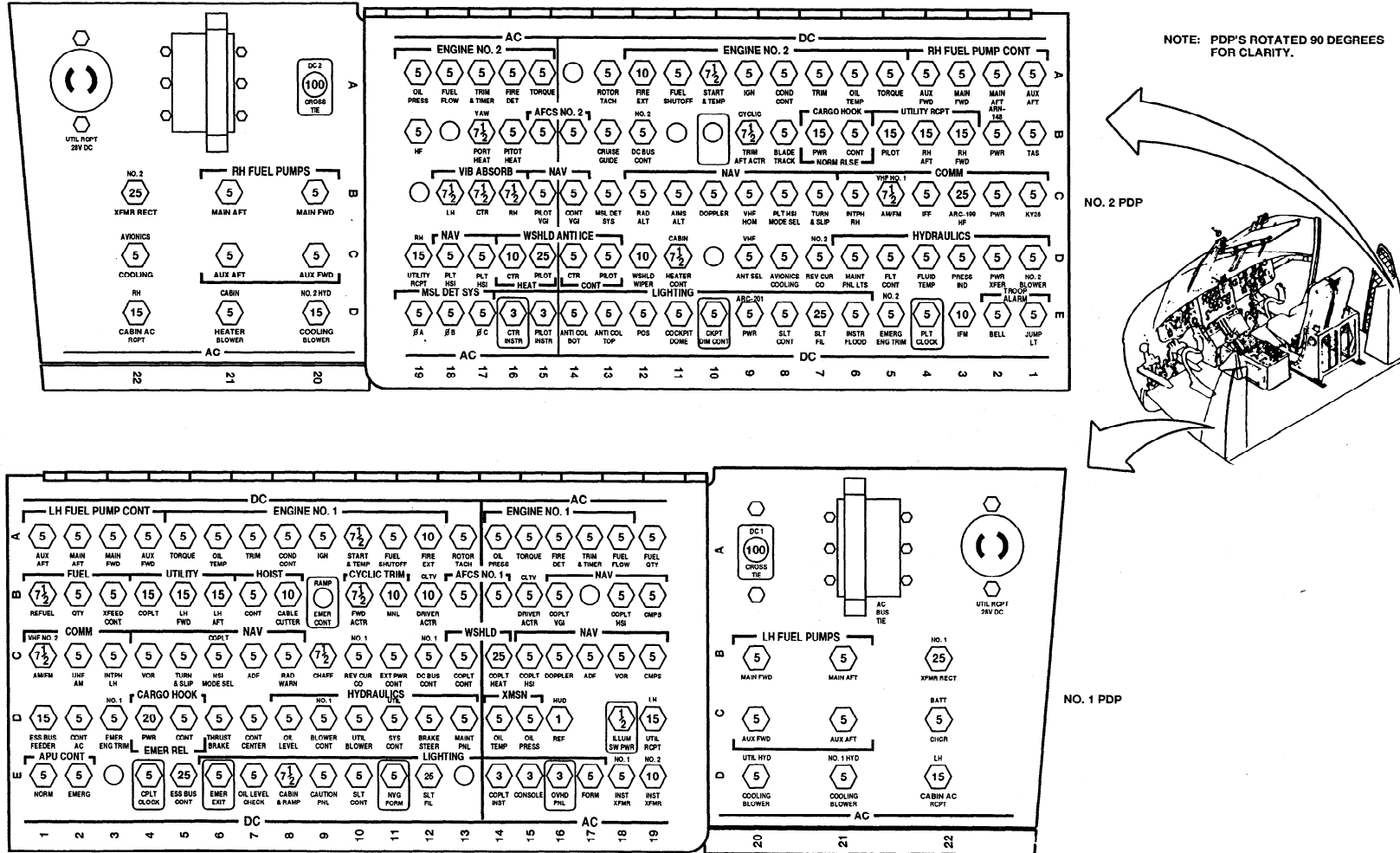


Figure 2-37. Power Distribution Panels (Typical) 712

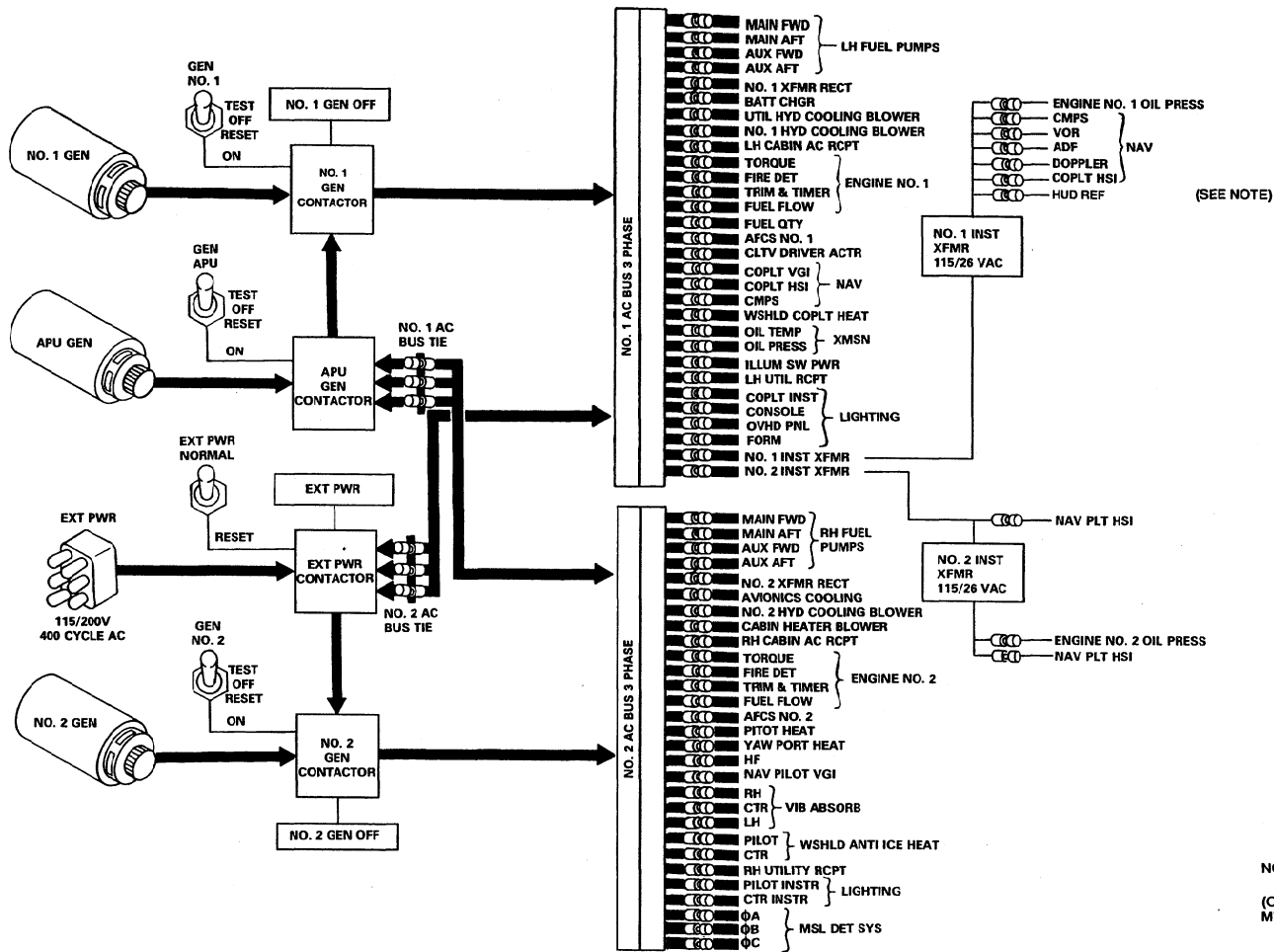
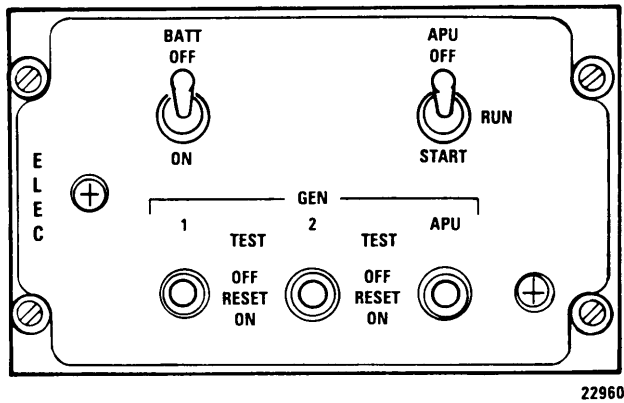


Figure 2-38. AC Power Supply (Typical) 712

A73383



**Figure 2-39. Electrical Power Panel**

the buses. At OFF RESET, the generator is deenergized and disconnected from the bus. This position is also used to reset a generator. The TEST position is provided to allow the generator to be energized but disconnected from the bus to determine whether the AC produced is of proper frequency and voltage.

**2-149. GEN OFF Cautions.** Two generator caution capsules labeled NO. 1 GEN OFF and NO. 2 GEN OFF are on the master caution panel (fig. 2-51). These caution capsules illuminate whenever the generators are inoperative. The capsules are controlled by the main generator contractors when the generator control switches are in either ON or OFF RESET. In TEST, the capsules are controlled by the generator control switch and will extinguish if generator output has the proper frequency and voltage. Power to operate the generator capsules is supplied by the DC essential bus through the LIGHTING CAUTION PNL circuit breaker on the No. 1 PDP.

**2-150. EXT PWR Caution.**

**CAUTION**

**When external power is used, a visual check shall be made by the crew to ensure that the external power unit has been disconnected from the helicopter before taxiing.**

An external power caution capsule labeled EXT PWR is on the master caution panel (fig. 2-51). This capsule illuminates and remains illuminated whenever external power is connected. The light is controlled by the AC external power contactor and the DC power relay. The capsule extinguishes when the generators are supplying current to the buses. Power to operate the external power caution capsule is supplied by the DC essential bus through the LIGHTING CAUTION PNL circuit breaker on the No. 1 PDP.

**2-151. DC System.**

The direct current (DC) power supply system supplies 28-volt DC from the No. 1 transformer rectifier (RECT) to No. 1 DC bus and the No. 2 RECT to No. 2 DC bus

(fig. 2-40). RECT convert 200 VAC power to 28-volt DC power for use in the DC distribution system.

Cooling air for the RECT is obtained from within the cabin. The air inlets are located at sta. 176 on the left and right side of the cabin behind the troop seats. If the inlets are blocked, the RECT will overheat.

A bus-tie relay is between No. 1 and No. 2 DC buses. If either RECT fails, the respective RECT failure relay operates and the bus-tie relay closes automatically to connect the unpowered bus to the operating RECT. In addition to No. 1 and No. 2 DC buses, the DC system includes an essential bus, a switched battery bus, and a battery bus.

During normal operation, the essential bus and the switched battery are energized by No. 1 DC bus. If both DC buses fail or if No. 1 DC bus fails and does not bus-tie to No. 2 DC bus, the essential bus, the switched battery bus, and the battery bus will be energized by the battery as long as the BATT switch is ON. These buses provide power to emergency, ground maintenance, and communications components. The battery bus and switched battery bus are energized as long as the battery is connected. The hydraulic reservoir level indicators and the emergency APU control circuits and cabin and maintenance lights are on these buses.

The 24-volt nickel-cadmium battery is located in the left forward electrical compartment. The battery capacity is 11 ampere-hours. A battery charger is connected to the battery. The battery charger receives power from No. 1 AC bus, rectifies the AC and applies the DC to the battery to maintain a charge on the battery.

Sensors in the battery charger detect battery or battery charger overtemperature, short or open circuits or cell imbalance. If any of these conditions occur, the battery charger will stop functioning and activates the BATT SYS MAL caution capsule on the master caution panel,

External DC power is supplied to the DC buses of the helicopter by connecting the external DC power source to the DC external power receptacle (fig. 2-36). Application of external power operates the DC external power relay which connects the power source to No. 1 DC bus. No. 2 DC bus is energized when the bus tie relay operates. If the polarity of the external power is reversed, a blocking diode in the circuit prevents the external power relay from closing.

**2-152. BATT Switch.**

**NOTE**

The following information applies only if the battery is the only source of power.

The BATT (battery) switch is located on the ELEC panel of the overhead switch panel (fig. 2-39). The two-position switch is labeled ON and OFF. When the switch is at ON, the essential, switched battery, and battery buses are energized. Regardless of the battery switch position, the switched battery and battery buses



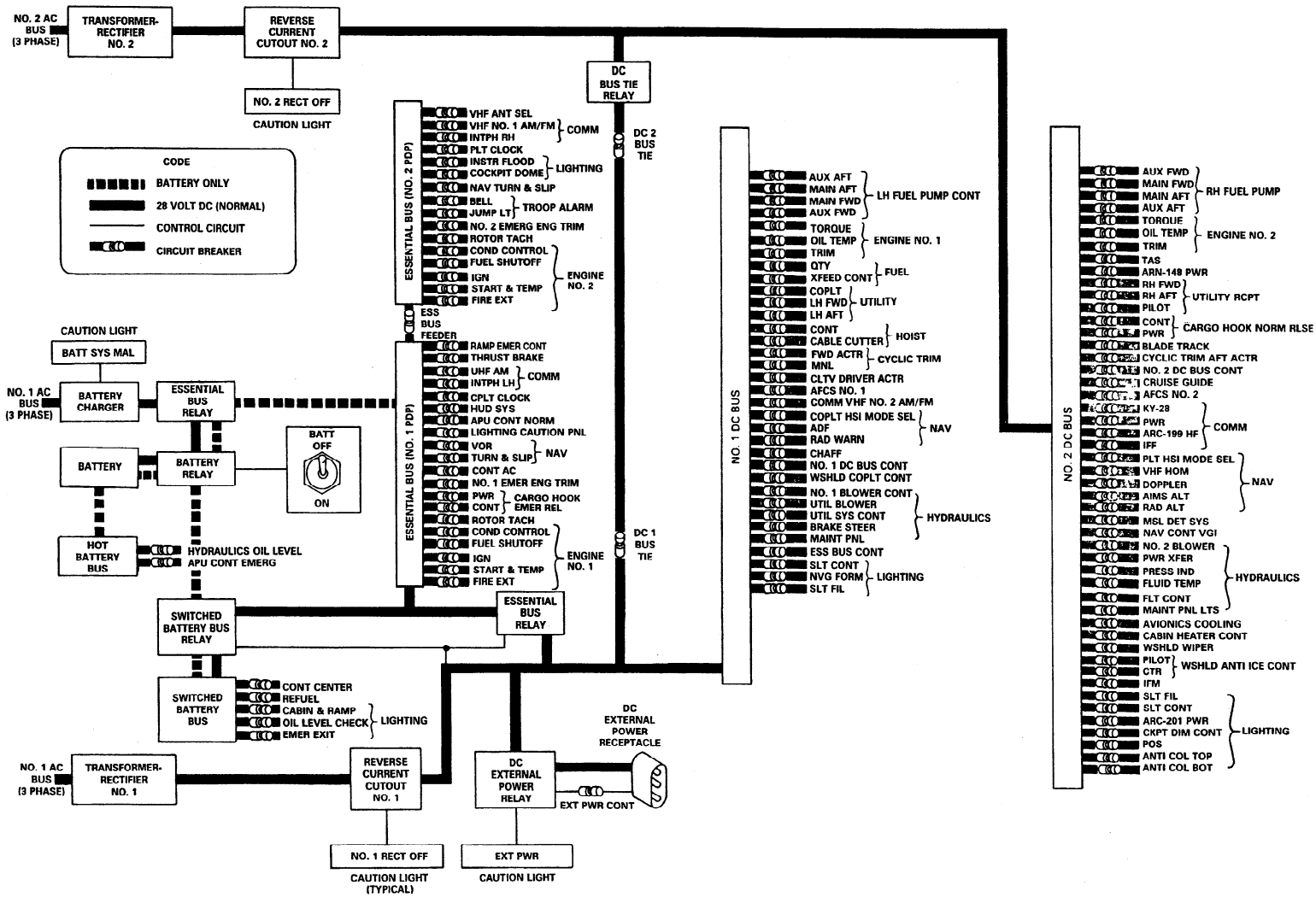
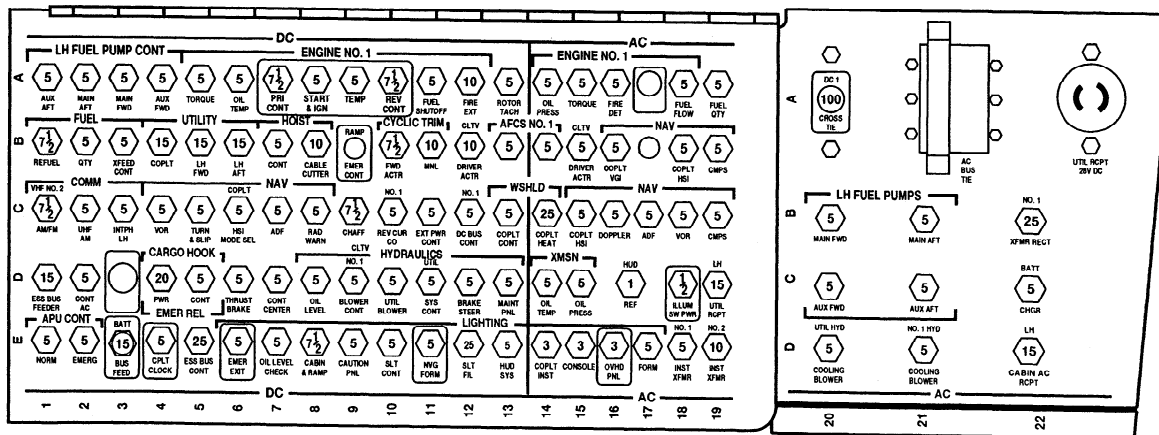
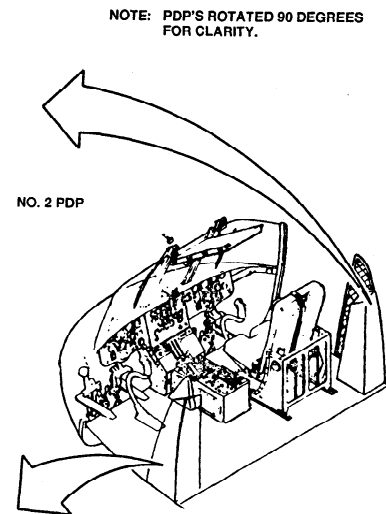
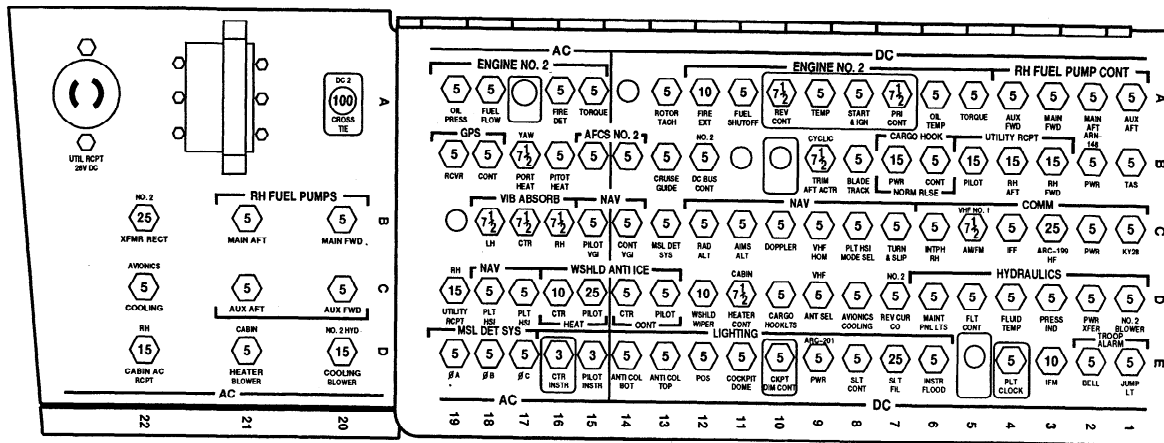


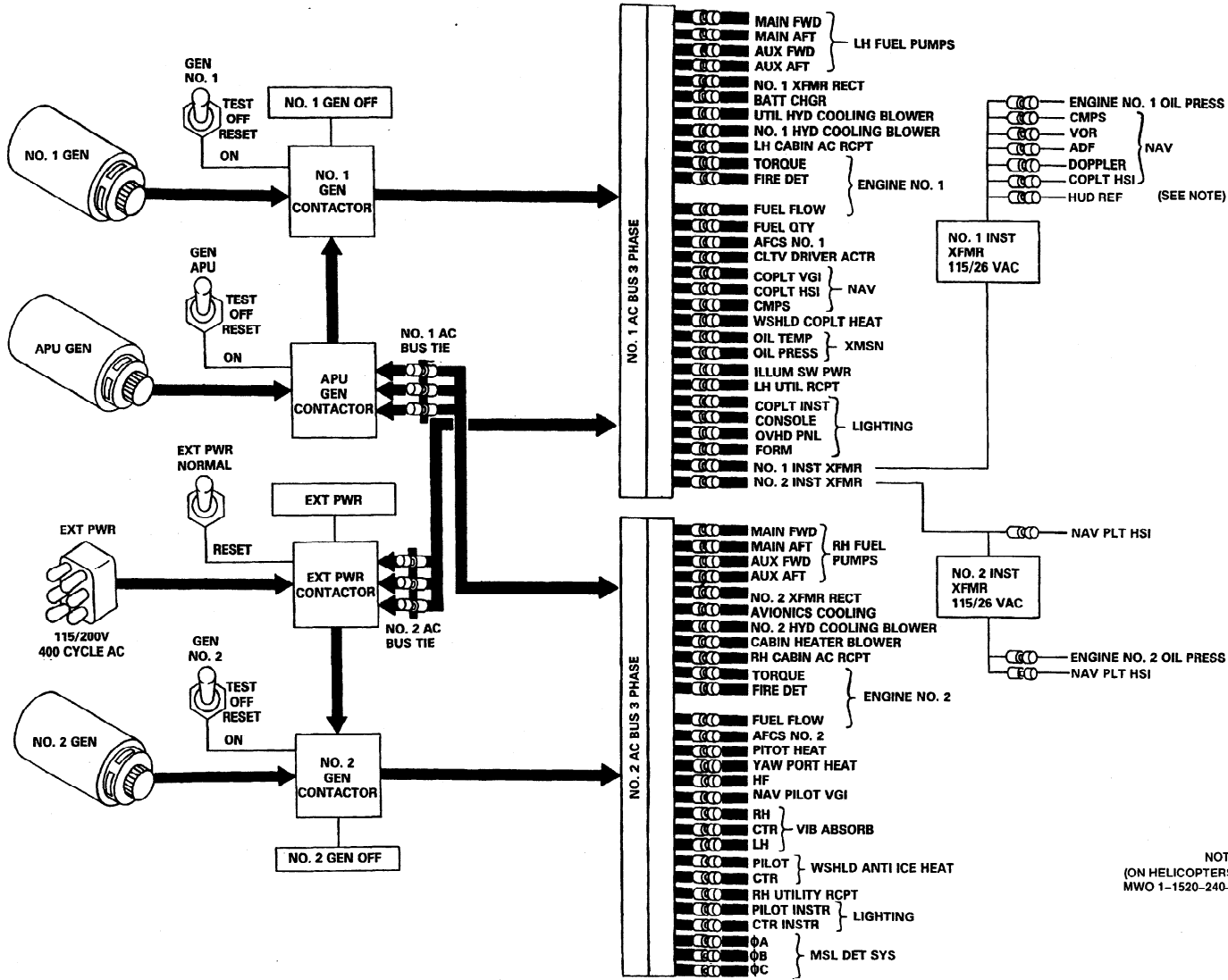
Figure 2-40. DC Power Supply (Typical) 712

A64418



NO. 1 PDP

Figure 2-40.1. Power Distribution Panels (Typical) 714A



NOTE  
 (ON HELICOPTERS MODIFIED BY  
 MWO 1-1520-240-50-56)

Figure 2-40.2. AC Power Supply (Typical) 714A

A73385

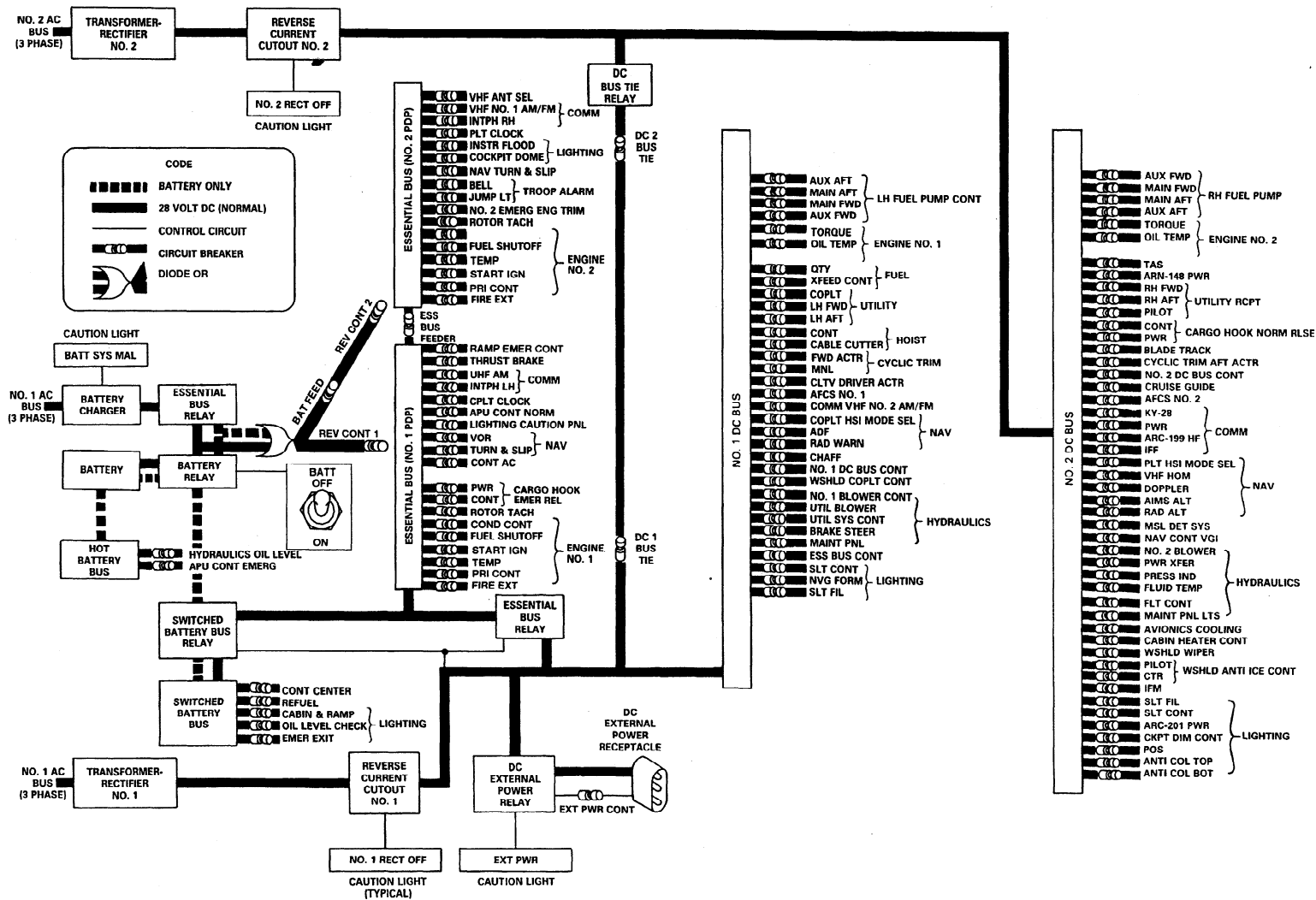


Figure 2-40.3. DC Power Supply (Typical) 714A

A73386

are powered directly by the battery. To prevent extensive discharging of the battery while making extended ground checks of equipment, use an external electrical power source or operate the APU generator.

**2-153. RECT OFF Cautions.** Two RECT caution capsules labeled NO. 1 RECT OFF and NO. 2 RECT OFF are on the master caution panel (fig. 2-51). These caution are controlled by the reverse-current cutouts. Whenever one of the RECT fails, either through a fault in the RECT or a bus fault, the respective caution illuminates. Power to operate the transformer rectifier capsules is supplied by the DC essential bus through the

LIGHTING CAUTION PNL circuit breaker on the No. 1 PDP.

**2-154. BATT SYS MAL Caution.**

A battery system malfunction caution capsule labeled BATT SYS MAL is on the master caution panel (fig. 2-51). This caution illuminates when the battery charger has stopped charging the battery. This can be caused by an overheated battery or battery charger, battery cell imbalance, or an output short or open circuit. Power to operate the capsule is supplied by the DC essential bus through the LIGHTING CAUTION PNL circuit breaker on the No. 1 PDP.

## SECTION XII AUXILIARY POWER UNIT

### 2-155. General.

The gas turbine auxiliary power unit T62-T-2B (APU) (fig. 2-41) is mounted in the aft cabin above the ramp. The basic components of the APU are the gas turbine engine, hydraulic motor-pump, fuel control, accessory drive, and AC generator. An APU ELECTRONIC SEQUENCING UNIT (ESU) which monitors APU operation is on the left side of the cabin above the ramp. The ESU is also labeled APU CONTROL BOX.

The motor-pump on the APU pressurizes the utility and hydraulic system for main engine starting and ground checks. The APU also drives an AC generator which supplies power to No. 1 and No. 2 electrical systems. Refer to Section VI for further information on the hydraulic systems. The APU oil supply is integral and contained within the sump of the accessory drive assembly. The APU receives fuel from the left main fuel tank through a booster pump, a manual fuel shutoff valve, and a solenoid valve.

### 2-156. ELECTRONIC SEQUENCING UNIT.

The ESU is mounted on the left side of the cabin above the ramp. The unit monitors APU starting and operation. In addition, it monitors APU speed and exhaust gas temperature. The unit continuously compares these parameters with limits programmed into ESU circuits. If a limit is exceeded, the ESU will automatically shut down the APU.

#### NOTE

The BITE indicators indicate engine condition only. They will not indicate a defective hydraulic motor-pump or generator.

Four magnetic built-in-test-equipment (BITE) indicators are on the ESU. These indicators are either black

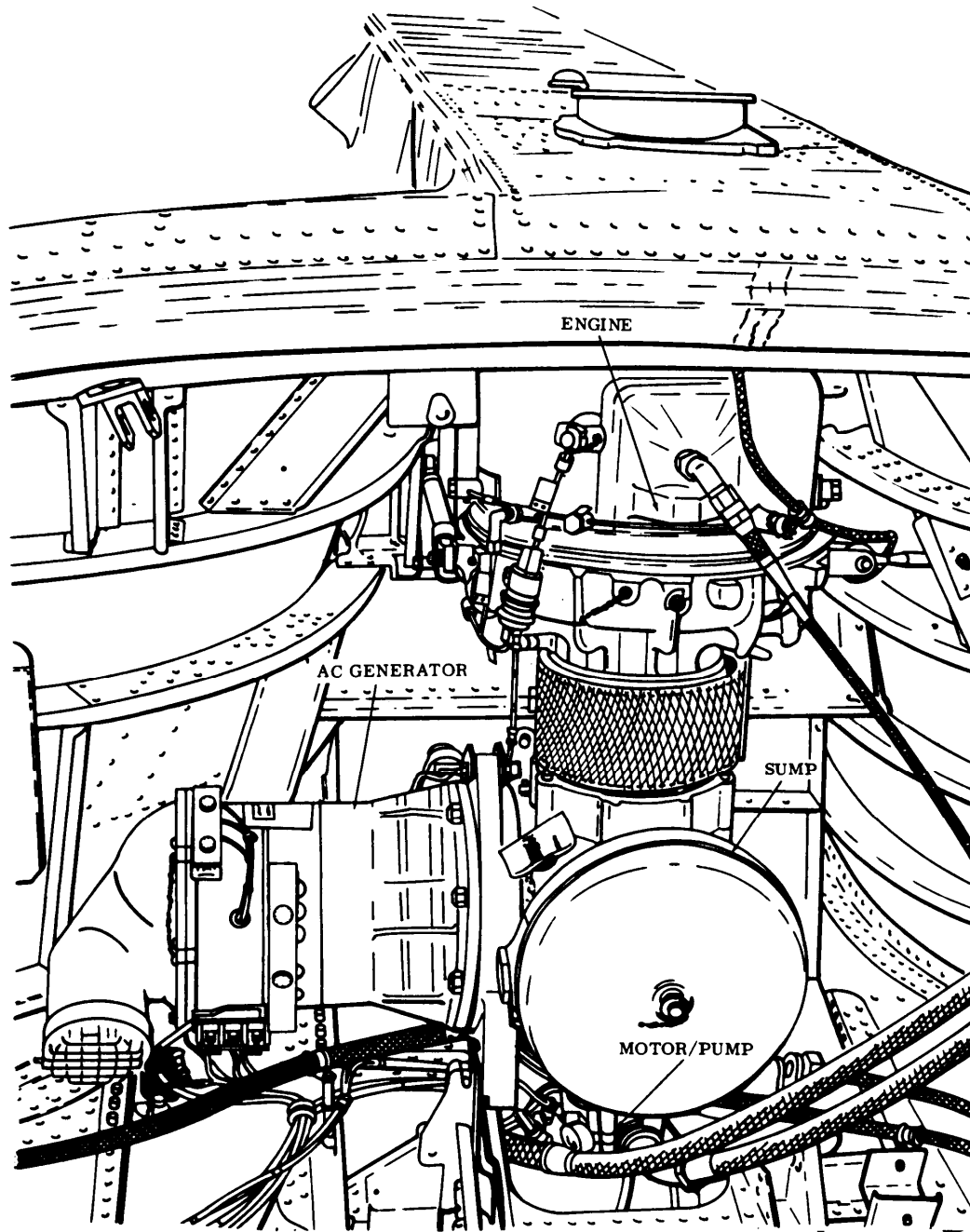
or white. A label on the ESU explains the various BITE indications and their meaning.

**2-157. APU Switch.** The APU switch is on the ELEC panel of the overhead switch panel (fig. 2-39). It is a three-position switch labeled OFF, RUN, and START. The switch is spring loaded from START to RUN. Normally, power to operate the APU is supplied by the DC essential bus through the APU CONT NORM circuit breaker on the No. 1 PDP. Emergency power to operate the APU is from the battery bus through the APU CONT EMERG circuit breaker on the No. 1 PDP.

**2-158. APU ON Caution.** The APU ON caution capsule is on the master caution panel (fig. 2-51). Normally, the APU is intended for ground operation only. It is not intended for operation during flight. If the caution remains illuminated following take-off, it alerts the pilot to shut down the APU. When the caution is illuminated, it indicates the APU is up to speed and the exhaust gas temperature is normal. It does not necessarily indicate that APU hydraulic pump or generator output is normal. If the rotors are not turning, check the UTIL HYD SYS and RECT OFF cautions to evaluate output of the APU hydraulic pump and generator. The APU ON caution is controlled by the ESU.

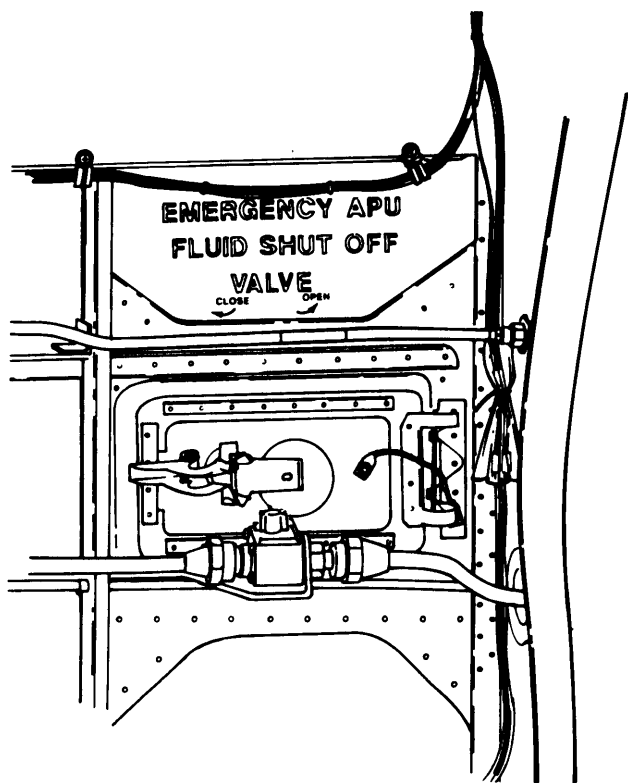
### 2-159. EMERGENCY APU FLUID SHUT OFF VALVE.

The EMERGENCY APU FLUID SHUT OFF VALVE is in the fuel supply line to the APU (fig. 2-42). It is located inside the aft cabin above and to the left of the ramp interphone station. The valve can also be reached from the outside through an access door labeled ACCESS APU EMER FLUID SHUT OFF. The knob on the valve has an OPEN and CLOSE position. Placing the knob to CLOSE shuts off fuel to the APU.



D145-96-10

Figure 2-41. Auxiliary Power Unit



23473

Figure 2-42. *Emergency APU Fluid Shut Off Valve*



## SECTION XIII LIGHTING (NVG)

### 2-160. Position Lights.

Three position lights (1, 4, and 6, fig. 2-43) are installed on the helicopter. On the right side of the fuselage is a green light (1); on the left, red (6); and on the vertical panel of the aft pylon, white (4). Power to operate the position lights is supplied by the No. 2 DC bus through the LIGHTING POS circuit breaker on the No. 2 PDP.

### 2-161. Position Light Switches.

a. *POSN Light Switch.* The POSN (position) switch is located on the EXT LTG (exterior lighting) panel on the left side of the overhead switch panel (fig. 2-12). The three-position switch is labeled DIM, OFF, and BRT. It adjusts the intensity of the position lights. When the switch is OFF, the position light system is deenergized.

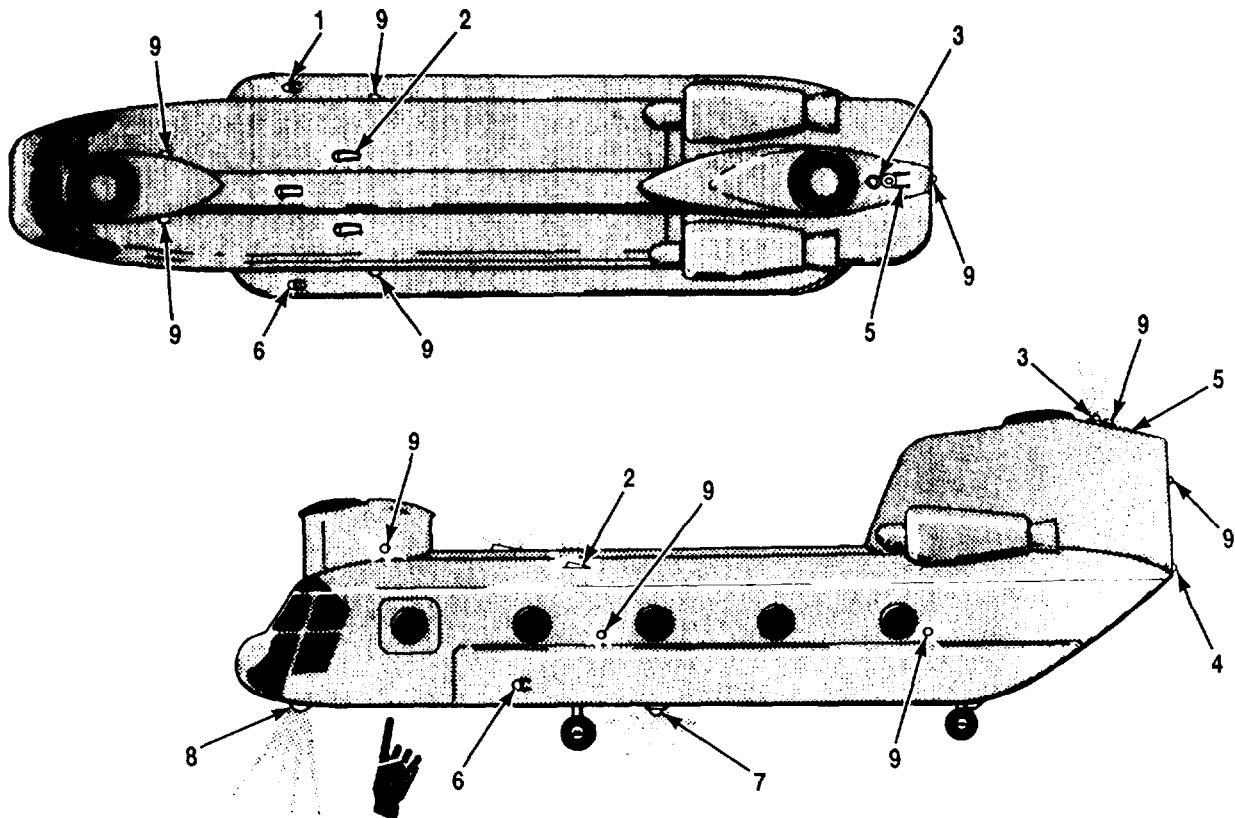
### NOTE

The crew chief must inform the pilot when the AFT POS LIGHT switch has been changed to the OFF position.

b. *AFT POS LIGHT Switch.* The AFT POS LIGHT switch is located in the cabin at sta. 534 near the MAINTENANCE PANEL (fig. 2-45). The guarded two-position switch is labeled OFF and ON. It allows the aft position light to be turned off during aided (NVG) operations and on during unaided night operations.

### 2-162. Formation Lights.

There are five electroluminescent panels for normal night formation operations (2 and 5, fig. 2-43) and eight NVG compatible formation lights for NVG formation operations (9, fig. 2-43).



- |                                 |                               |
|---------------------------------|-------------------------------|
| 1. Right position light (Green) | 6. Left position light (Red)  |
| 2. Formation lights (3)         | 7. Bottom anticollision light |
| 3. Top anticollision light      | 8. Landing-search lights (2)  |
| 4. Position light (White)       | 9. NVG formation lights (8)   |
| 5. Formation lights (2)         |                               |

A50277

Figure 2-43. Exterior Lights

a. *Electroluminescent Panels.* Three panels which form an equilateral triangle are aft of the forward pylon. Two panels are on the top of the aft pylon aft of the anticollision light. Power to operate and control the electroluminescent formation lights is supplied by the LIGHTING FORM circuit breaker on the No. 1 PDP.

b. *NVG Formation Lights.* There is an NVG formation light on each side of the forward pylon, two NVG formation lights on each side of the fuselage, two NVG formation lights on the aft pylon, one aft of the anticollision light, and one on the vertical panel at the rear of the aft pylon. Power to operate and control the NVG formation lights is supplied by the No. 1 DC bus through the LIGHTING NVG FORM circuit breaker on the No. 1 PDP.

**2-163. FORM Light Switches.** The FORM (formation) light select and control switches are located on the EXT LTG panel on the left side of the overhead switch panel (fig. 2-12).

a. *FORM Light Select Switch.* A two-position toggle switch labeled NVG and NORM. In the NORM position, the five electroluminescent panels may be controlled by the FORM light rotary control switch for normal night formation operations. In the NVG position, the eight NVG formation lights may be controlled by the FORM light rotary control switch for NVG night formation operation.

b. *FORM Light Control Switch.* A rotary control switch labeled OFF, DIM, and BRT with three evenly spaced incremental markings between DIM and BRT. It adjusts the intensity of the formation lights selected by the FORM light select switch. When the rotary control switch is OFF, the formation light system is deenergized.

**2-164. Anticollision Lights.**

Two red strobe anticollision lights are on the helicopter (3 and 7, fig. 2-43). One is on top of the aft pylon and the other is on the fuselage underside. Power to operate the anticollision lights is supplied by the No. 2 DC bus through the LIGHTING ANTI COL TOP and BOT circuit breakers on the No. 2 PDP.

**2-165. ANTI COL Light Switches.** Two ANTI COL TOP and BOT toggle switches are on the EXT LTG panel on the left side of the overhead switch panel (fig. 2-12). Each two-position switch is labeled OFF and ON. When the anticollision light switch is ON, the lights are energized. When the switch is placed to OFF, the anticollision lights are deenergized.

**2-166. Landing Searchlights.**

Two controllable landing-searchlights are mounted on the bottom of the fuselage (8, fig. 2-43). One is controlled from the pilot THRUST CONT lever and the other from the copilot THRUST CONT lever. The copilot light is equipped with an infrared (IR) filter for NVG operations.

Each light is operated independently by a SRCHLT CONTR switch, SLT-FIL (searchlight filament), and position switch. They may be extended and stopped at any angle up to 90° in a vertical plane and rotated 360° about its vertical axis as long as the searchlight position switch is displaced. For

normal operations use the pilot searchlight and landing light. For NVG operations use the copilot searchlight and landing light.

**2-167. SRCHLT CONTR Switch.** Two SRCHLT CONTR (searchlight control) switches are on the overhead switch panel (fig. 2-44). The PLT SRCHLT CONTR switch is on the PLT LTG panel. The CPLT SRCHLT CONTR switch is on the CPLT LTG panel. Each two-position switch is labeled RET and ON.

When the SRCHLT CONTR switch is placed to ON, the SLT-FIL switch on the THRUST CONTR lever becomes operational. If the searchlight is at any angle off center when the SRCHLT CONTR switch is placed to RET, the searchlight will automatically rotate to point forward and then will retract flush with the fuselage. Power is supplied by the No. 1 and No. 2 DC bus through the LIGHTING SLT CONT circuit breakers on the No. 1 and No. 2 PDP.

**2-168. SLT-FIL Switch.**

**CAUTION**

The copilot landing searchlight emits invisible infrared rays which may be hazardous to personnel looking directly at the light at close range or touching it. Ensure that the copilot landing SLT-FIL switch is OFF and the light fully retracted when it is not in use.

A SLT-FIL (searchlight filament) switch is located on the pilot and copilot THRUST CONT lever switch bracket (fig. 2-26.) Each switch is labeled ON and OFF. The switches turn on the landing-searchlight lamp, before or after extension. Power to operate the landing searchlight lamp is supplied by the No. 1 and No. 2 DC bus through the LIGHTING SLT FIL circuit breakers on the No. 1 and No. 2 PDP.

**2-169. SEARCH LIGHT Position Switch.**

**CAUTION**

Do not confuse the SEARCH LIGHT position switch with the two engine beep trim switches.

A five-position momentary SEARCH LIGHT switch is on each THRUST CONTR lever switch bracket (fig. 2-26). It is labeled L (left), EXTEND, R (right), and RETRACT. The switch is spring-loaded to center off position.

When the SRCHLT CONTR and SLT-FIL switches are ON, the searchlight can be controlled up and down or left and right with the SEARCH LIGHT position switch. Power to operate the searchlight position switch is supplied by the No. 1 and No. 2 DC bus through the LIGHTING SLT CONT circuit breaker on No. 1 and No. 2 PDP.

**2-170. Overhead Switch Panel Lights.**

The overhead switch panel has integral lighting. Power to operate and control the overhead panel lights is supplied by

the No. 1 AC bus through the LIGHTING OVHD PNL circuit breaker on the No. 1 PDP.

left side of the overhead switch panel (fig. 2-44).

**2-171. OVHD CSL Switch.** The OVHD CSL (overhead console) switch is located on the CPLT LTG panel on the

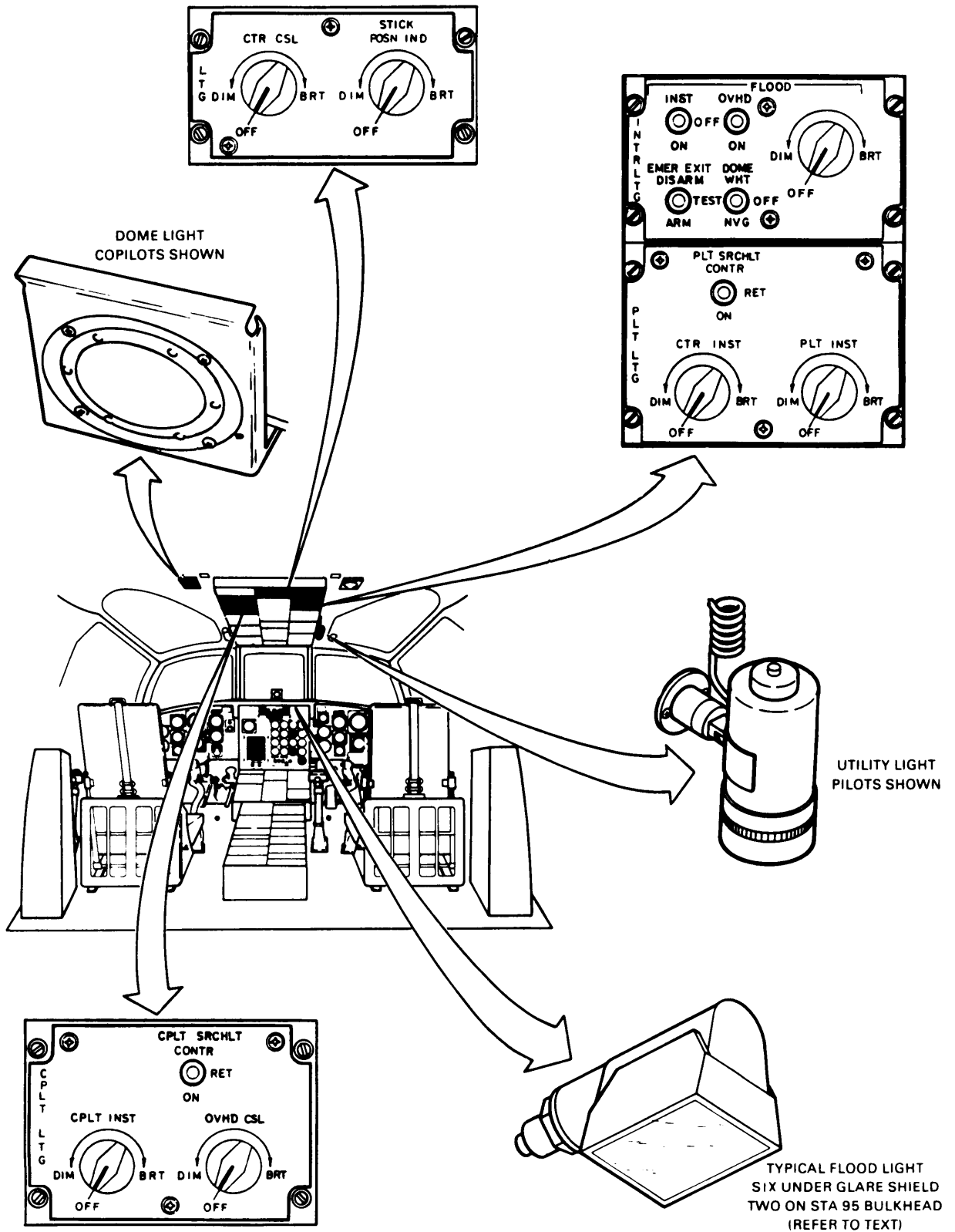


Figure 2-44. Cockpit Lighting and Control

The rotary control switch is labeled OFF, DIM, and BRT. It adjusts the light level from DIM to BRT. When the rotary control switch is OFF, the overhead switch panel light system is deenergized.

**2-172. Pilot and Copilot Instrument Panel Lights.**

All flight instruments and placards on both pilot and copilot instrument panels receive lighting. The HSI, attitude indicator (VGI), radar altimeter, and turn and slip indicator for both pilot and copilot have integral lighting. The remaining instruments are externally lit by lighting posts adjacent to the instruments. Power to operate and control the pilot flight instrument lights is supplied by the No. 2 AC bus through the LIGHTING PILOT INSTR circuit breaker on the No. 2 PDP. Power to operate and control the copilot flight instrument lights is supplied by the No. 1 AC bus through the LIGHTING COPLT INST circuit breaker on the No. 1 PDP.

**2-173. PLT and CPLT INST Switches.** The PLT INST (pilot instrument) control switch is located on the PLT LTG panel on the right side of the overhead switch panel (fig. 2-44). The CPLT INST (copilot instrument) control switch is located on the CPLT LTG panel on the left side of the overhead switch panel. The rotary control switches are labeled OFF, DIM, and BRT. They adjust the light level from DIM to BRT. When the rotary control switch is OFF, the respective instrument panel light system is deenergized.

When the PLT INST rotary control switch is placed out of the OFF detent, the following lighting is dimmed:

- a. Troop warning jump lights on the overhead switch panel and on the emergency troop alarm and jump lights boxes on the cargo compartment.
- b. The legend on pushbutton switches on the heading and altitude section of the AFCS panel.
- c. The legend on pushbutton switches on the pilot and copilot HSI MODE SELECT panels.
- d. The legend on STATUS pushbutton switch on the countermeasure set AN/ALQ-156 control panel.

**2-174. Center Instrument Panel Lights.**

The center instrument panel as well as the fire warning panel are lighted. Power to operate and control the center instrument panel lights is supplied by the No. 2 AC bus through the LIGHTING CTR INSTR circuit breaker on the No. 2 PDP.

**2-175. CTR INST Switch.** The CTR INST control switch is located on the PLT LTG panel on the right side of the overhead switch panel (fig. 2-44). The rotary control switch is labeled OFF, DIM, and BRT. It adjusts the light level from DIM to BRT. When the rotary control switch is OFF, the respective instrument panel light system is deenergized.

**2-176. Canted and Center Console Lights.**

**NOTE**

The console lights are incompatible with NVG. During NVG operations, turn the console lights off and light the console with utility lights or floodlights.

Lighting is provided for all control panels on the canted and center console. Power to operate and control the console lights is supplied by the No. 1 AC bus through the LIGHTING CONSOLE circuit breaker on the No. 1 PDP.

**2-177. LTG Panel.** The LTG panel is located at the rear of the overhead switch panel (fig. 2-44). It consists of the CTR CSL and STICK POSN IND control switches.

a. *CTR CSL Switch.* Rotary control switch labeled OFF, DIM, and BRT. It adjusts the light level on the canted and center consoles from DIM to BRT. When the rotary control switch is OFF, the canted and center consoles light system is deenergized.

b. *Stick POSN IND Switch.* Rotary control switch labeled OFF, DIM, and BRT. It adjusts the light level on the stick position indicator from DIM to BRT. When the rotary control switch is OFF, the stick position indicator light system is deenergized.

**2-178. Dome Lights.**

**WARNING**

**If the white dome light is turned on during NVG operations, the effectiveness of the NVG may be severely impaired and a hazardous situation may be created due to sudden loss of pilot visual references. Do not turn on the white dome lights during NVG operations.**

Two cockpit dome lights are attached to the overhead structure adjacent to the overhead switch panel (fig. 2-44). Each dome contains a white lamp and a blue NVG filtered lamp which can be selected individually. Power to operate and control the dome lights is supplied by the DC essential bus through the LIGHTING COCKPIT DOME circuit breaker on the No. 2 PDP.

**2-179. DOME Switch.** The DOME switch is located on the INTR LTG panel at the right rear of the overhead switch panel (fig. 2-44). The three-position positive-locking switch is labeled WHT, OFF, and NVG. It selects the function of the dome light. The center position lever locking switch prevents inadvertent white light activation during NVG operations.

When the DOME switch is placed to WI-IT, the master caution panel cannot be dimmed. If WHT is selected while the caution panel is operating on DIM, the caution lights will automatically switch to BRT mode. During NVG operations, the DOME switch should only be placed to NVG.

**2-180. Pilot and Copilot Utility Lights.**

Two utility lights, connected to individual flexible cords, are mounted in two retaining sockets on either side of the overhead switch panel above the pilot and copilot (fig. 2-44). The lights are detachable and can be moved about to take care of special lighting situations. Each utility light has a rheostat switch as an integral part of its assembly. This switch, located on the aft part of the light, regulates the intensity of the light from OFF to BRT. A white button on the light housing, opposite the switch, is used for flashing the light. By selecting the color desired on the barrel of the light, blue or white light will be emitted. Power to operate the utility light is supplied by the No. 2 DC bus through the LIGHTING COCKPIT DOME circuit breaker on the No. 2 PDP.

**2-181. Floodlights.**

Eight floodlights provide a secondary source of light (fig. 2-44). Six are under the glareshield and two on the cockpit bulkhead. The six floodlights under the glareshield light the pilot, center, and copilot instrument panel. The two overhead floodlights light the overhead switch panel. Power to operate and control the floodlights is supplied by the DC essential bus through the LIGHTING INSTR FLOOD circuit breaker on the No. 2 PDP.

**2-182. FLOOD Switches.** The FLOOD switches are located on the INTR LTG panel at the right rear of the overhead switch panel (fig. 2-44). They consist of two floodlight selection switches and a rotary control switch. The floodlight selection switches are labeled INST and OVHD. Each switch has an OFF and ON position. The rotary control switch is labeled OFF, DIM, and BRT.

a. *INST and OVHD Floodlights Selection Switches.* Each switch is labeled for the area the floodlights will light. By placing either switch ON, the associated floodlights will light when the floodlight rotary control switch is turned toward BRT. Placing the switch to OFF deenergizes the floodlight circuit.

b. *Floodlight Rotary Control Switch.* The rotary control switch is used to adjust the floodlights from DIM to BRT once the respective floodlight selection switch is placed to ON. When the rotary control switch is OFF, the floodlights will be deenergized.

**2-183. Emergency Floodlights.**

If the pilot flight instrument lights have been turned on, loss of electrical power will cause the floodlights to automatically come on. All floodlights will function automatically in the BRT mode. Simultaneous dimming control of all floodlights can be regained by setting the FLOOD INST and OVHD selection switches to ON, turning the floodlight rotary control switch to BRT on the INTR LTG panel, and turning the PLT INST rotary control switch to OFF. Floodlight intensity can be controlled by the floodlight rotary control switch on the INTR LTG panel.

**2-184. Cabin and Ramp Lights.**

Five cabin and ramp lights are in the cabin, attached to the overhead structure (fig. 2-45). Each light contains

an NVG blue lamp and a red lamp which can be selected individually. Power to operate and control the cabin and ramp lights is supplied by the switched battery bus through the LIGHTING CABIN & RAMP circuit breaker on the No. 1 PDP.

**2-185. CABIN AND RAMP LIGHTS Switches.** The CABIN AND RAMP LIGHTS switches are located on a control panel below the ramp control lever. The control panel consists of a select switch and a CONTROL rotary switch.

a. *Select Switch.* Three-position toggle switch labeled RED, OFF, and NVG. It is used to select the appropriate cabin and ramp lights. When placed to OFF, cabin and ramp lights are deenergized.

b. *CONTROL Switch.* Rotary switch labeled DIM and BRT. It adjusts the cabin and ramp RED or NVG light level from DIM to BRT.

**2-186. Emergency Exit Lighting.**

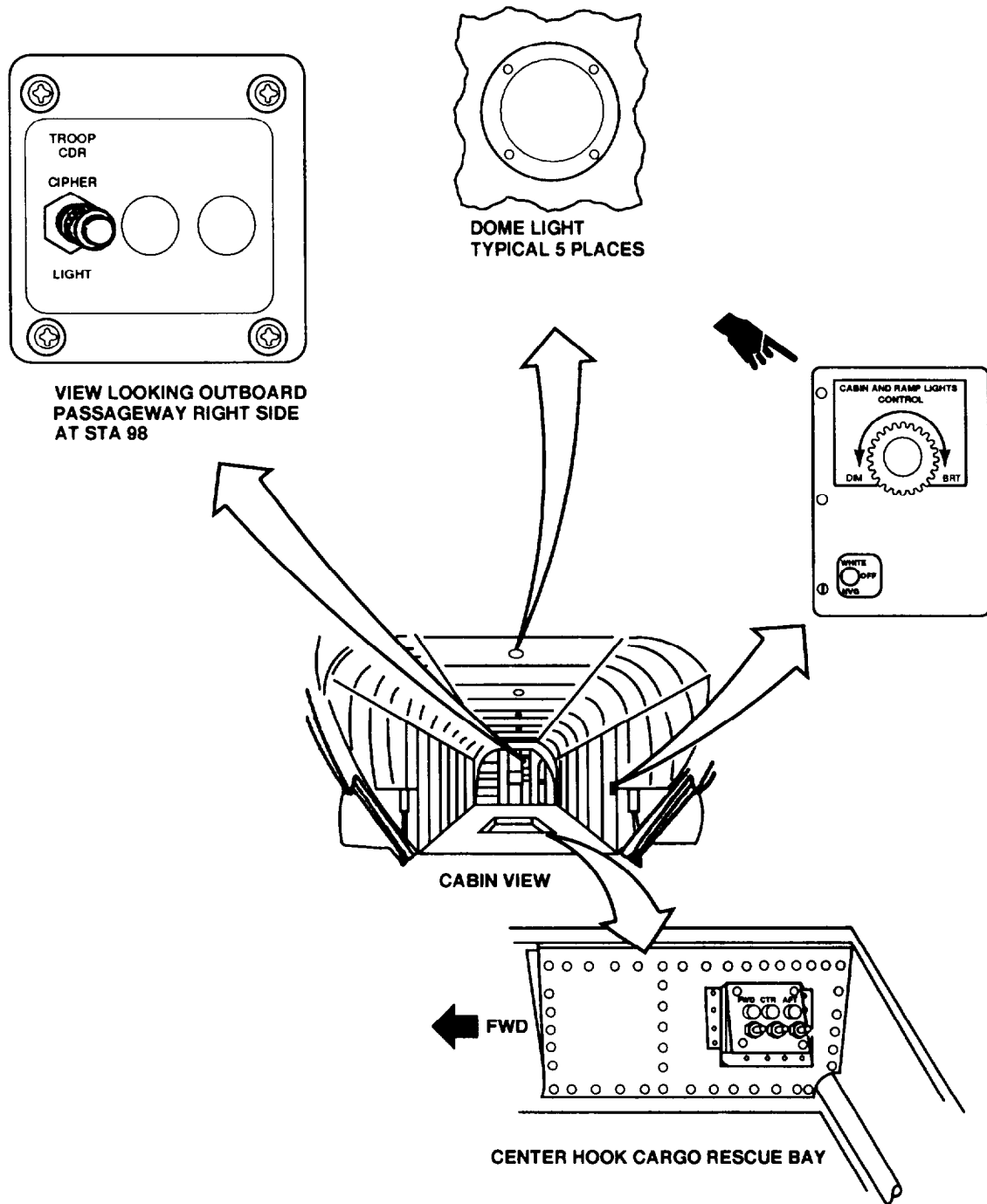
Three emergency exit lights are in the cargo compartment close to each of the three primary emergency exits (fig. 2-46). They are located by the main cabin door, the emergency exit opposite the main cabin door, and the ramp emergency exit. The lights come on whenever a loss of power on the switched battery bus occurs or during a landing when 3 to 4g's are exceeded as sensed by an inertia switch.

The emergency exit lights system is controlled by the EMER EXIT switch on the INTR LTG panel of the overhead switch panel. The lights may also be used as portable lamps by removing them from their housing and by rotating the handle, marked PULL EMERGENCY LIGHT, 45° from its normal position. Power to operate the emergency exit lights is supplied by two, internal, 1.25 volt, nickel-cadmium batteries. Power to operate and control the charging, monitoring, and test circuit is supplied by the switched battery bus through the LIGHTING EMER EXIT circuit breaker on the No. 1 PDP.

**2-187. EMER EXIT Switch.****CAUTION**

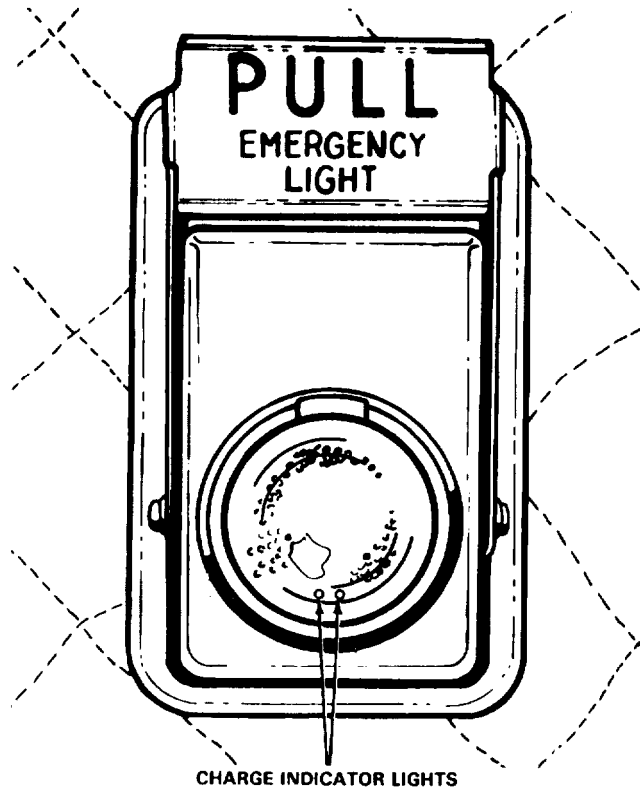
**If the EMER EXIT switch is left in ARM or DISARM with the helicopter shutdown and the battery connected, the charging circuit of the emergency exit light system will discharge the helicopter battery.**

The EMER EXIT switch is located on the INTR LTG panel of the overhead switch panel (fig. 2-44). The three-position switch is labeled DISARM, TEST, and ARM. When the switch is placed to ARM, the emergency exit lights stay off, the batteries are charging, and the charge indicator lights come on. The circuit monitors electrical failures and landings in excess of 3 to 4g's. The light from the charge indicator lamps can be seen emitting through two pin holes at the base of the main



A58253

Figure 2-45. Cabin Lighting and Controls



**Figure 2-46. Emergency Exit Light**

11959

light reflector. When the switch is set from ARM to TEST, the main light comes on, powered by the batteries. When the

switch is set to DISARM, the indications are the same as for the ARM position, except the circuit does not monitor electrical failures and hard landings.

#### **2-188. Forward Transmission Oil Level Check Lights.**

The forward transmission floodlight provides light to check the oil level of the transmission. The floodlight is near the sight gage on the transmission. Power to operate and control the oil level check light is supplied by the switched battery bus through the LIGHTING OIL LEVEL CHECK circuit breaker on the No. 1 PDP.

#### **2-189. Oil Level Check Light Switch.**

The OIL LEVEL CHECK LT SW is inside the cockpit on the canted bulkhead at sta. 95 above the pilot seat. It is a two-position switch labeled ON and OFF. When placed to ON, the oil check light turns on by the forward transmission.

#### **2-189.1. Cargo Hook Lights.**

Three cargo hook lights have been provided to illuminate the cargo hooks during normal and NVG sling loading operations. A light is mounted adjacent to each cargo hook, and is controlled by a two-position switch marked FWD, CTR, and AFT on the cargo hook light switch box. The cargo hook lights switch box is mounted on the coaming at STA. 360 in the center cargo hook well.



## SECTION XIV FLIGHT INSTRUMENTS

### 2-190. General.

The following paragraphs contain information on the flight instruments. Information on the navigation instruments will be found in Chapter 3, Avionics. All other instruments directly related to one of the helicopter systems are found under the appropriate system heading in this chapter. Refer to fig. 2-6, 2-7, 2-8, 2-9, 2-10, and 2-12 for illustrations of the instrument panels, canted and center consoles, and overhead switch panel.

### 2-191. Cruise Guide Indicator System.

The cruise guide indicator (CGI) system gives the pilot a visual indication of actual loads imposed on critical components of the helicopter dynamic system. The system allows the pilot to achieve maximum helicopter utilization under various conditions of payload, altitude, airspeed, ambient temperature, and center-of-gravity. The system consists of strain gages bonded to fixed links in the forward and aft rotor controls, an indicator, a signal processor unit in the aft pylon, a signal conditioner unit in the forward pylon, and interconnecting wiring. The system measures alternating stress loads at each rotor and displays the larger of the two signals. Power to operate the cruise guide indicator system is supplied by No. 2 DC bus through the CRUISE GUIDE circuit breaker on the No. 2 PDP.

**2-192. CRUISE GUIDE Indicator.** The CRUISE GUIDE indicator is on the pilot instrument panel (fig. 2-47). Three bands are displayed on the dial face of the indicator. These bands are colored green, yellow, and striped red-and-yellow. Refer to fig. 5-1 for limitations. Immediate corrective action must be taken to reduce

stress when in the red-and-yellow striped band. This can be accomplished by lowering THRUST CONT lever, reducing airspeed, releasing back pressure on the cyclic stick, or by reducing the severity of the maneuver.

**2-193. CGI TEST Switch.** The CGI TEST switch is on the pilot instrument panel, on the left side of the indicator (fig. 2-47). It is a three-position switch spring loaded to center off position labeled FWD and AFT.

### NOTE

Do not test the cruise guide system with rotors turning. False indications will result.

When the switch is placed from center position to each test position, the pointer on the indicator should indicate within the white test band. The white test band indicates proper system operation.

When the test function is activated, circuits from the strain gages to the indicator are tested. However, separation of the bond of the strain gage to a link will not be detected by the test function. The narrow white line towards the high end of the striped red-and-yellow band is used for calibrating the indicator during bench test.

### 2-194. Airspeed Indicator.

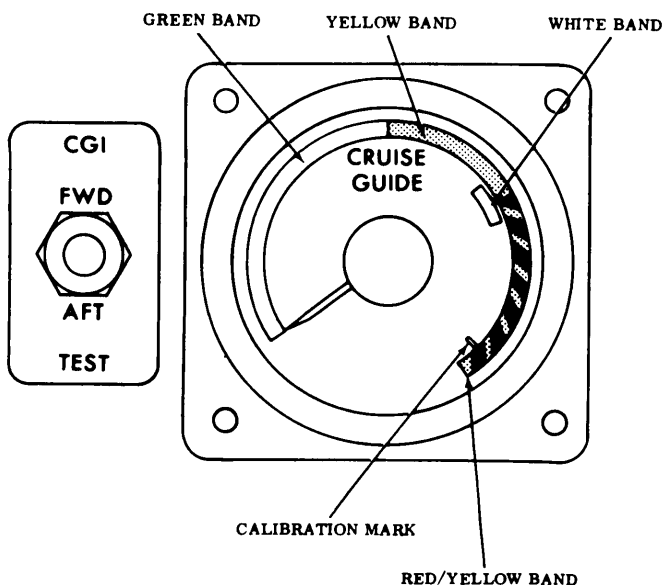
There are two airspeed indicators located on the upper left portion of the copilot and pilot instrument panel (fig. 2-8 and 2-10). The difference between dynamic pressure and static pressure as measured by the pitot static system is introduced into these instruments. Indicated airspeed is shown in knots.

### 2-195. Altimeter.

An AIMS altimeter is provided for the pilot (fig. 2-48). In the term AIMS, the A stands for Air Traffic Control Radar Beacon System (ATCRBS), the I stands for identification friend or foe (IFF), the M represents the Mark XII identification system, and the S means system. A pneumatic counter-drum-pointer type altimeter is installed for the copilot. The pilot's altimeter is a pneumatic counter-drum-pointer type which is a self-contained unit consisting of a precision pressure altimeter combined with an altitude encoder.

Simultaneously, the display indicates and the encoder transmits through the transponder the altitude of the helicopter. Altitude is displayed on the altimeter by a 10,000-foot counter, and a 100-foot drum. A single pointer indicates hundreds of feet on a circular scale with 50-foot center markings. Below 10,000 feet, a diagonal warning symbol will appear on the 10,000 foot counter. Power to operate the AIMS altimeter is supplied by the No. 2 DC bus through the NAV AIMS ALT circuit breaker on the No. 2 PDP.

A barometric pressure setting knob is provided to insert the desired altimeter setting in inches of Hg. A vibrator



D145-53-10

Figure 2-47. Cruise Guide Indicator

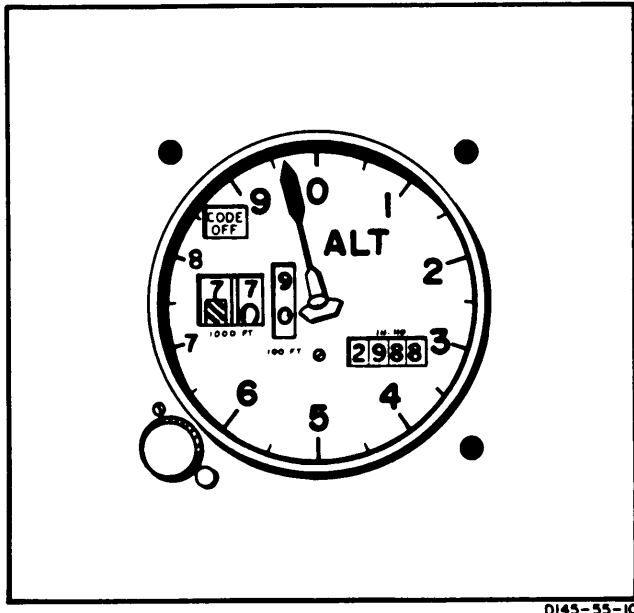


Figure 2-48. AIMS Altimeter

powered by No. 2 DC bus is contained in the altimeter and requires a minimum of 1 minute warmup before checking or setting the altimeter. If DC power to the altitude encoder is lost, a warning flag placarded CODE OFF appears in the upper left instrument dial.

The flag indicates that the altitude encoder is inoperative and that the system is not reporting altitude to ground stations. The CODE OFF flag monitors only the encoder function of the altimeter. It does not indicate transponder condition. The AIMS altitude reporting function can be inoperative without the CODE OFF flag showing, as in case of transponder failure or improper control settings. It is also possible to get a good Mode C test on the transponder control with the CODE OFF flag showing. Display of the CODE OFF flag only indicates an encoder power failure or a CODE OFF flag failure. In this event, check that DC power is available and that the circuit breakers are in. If the flag is still visible, radio contact should be made with a ground radar site to determine whether the AIMS altitude reporting function is operative. The remainder of the flight should be conducted accordingly.

#### 2-196. Preflight Operation - Altimeter.

If the AIMS altimeter encoding function is to be used during a flight, perform the following steps before takeoff

#### CAUTION

**If the baro set knob binds or sticks, do not use excessive force to set the altimeter. Excessive force can damage altimeter gears, resulting in altimeter error. Settings can sometimes be made by backing off the knob and turning at a slower rate.**

a. Set the pilot's altimeter to the field barometric setting.

b. Check that the pilot's altimeter indicates within  $\pm 70$  feet of field elevation. If the altimeter error is greater than  $\pm 70$  feet, do not use the altimeter for IFR flight.

#### 2-197. In Flight Operation - Altimeter.

Operate the AIMS altimeter encoding function as follows:

- Be sure the IFF set is on and set to the proper code.
- Be sure the altimeter is set to the local altimeter setting.
- Set the M-C (mode c) switch on the IFF control panel to ON.
- Check that the red CODE OFF flag is not visible in the pilot's altimeter.

The copilot's altimeter is a pneumatic counter-drum-pointer type which displays altitude in the same manner as the pilot's altimeter. It also incorporates a barometric pressure setting knob and an internal vibrator powered by the No. 2 DC bus. A **minimum of 1** minute of vibrator operation is required before setting or checking the altimeter.

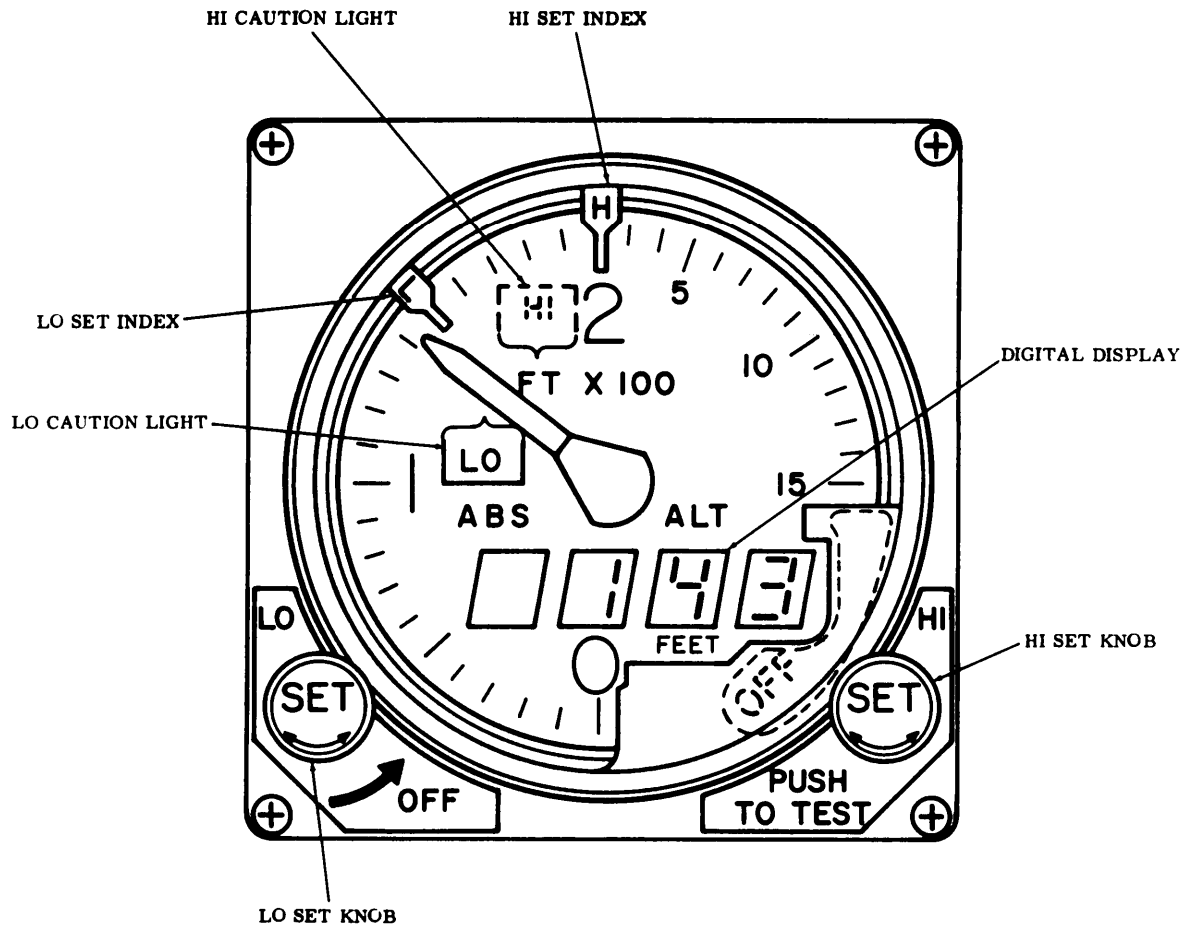
At ambient pressure, both altimeters should agree within  $\pm 70$  feet of the field elevation when the proper barometric pressure setting is set in the altimeter. If the internal vibrator of either altimeter becomes inoperative due to DC power failure, the pointer drum may momentarily hang up when passing from **9** through **0** (climbing) or from **0** to **9** (descending). This will cause a lag of magnitude which will depend on the vertical velocity of the aircraft and the friction in the altimeter.

**2-198. Radar Altimeter (AN/APN-209A).** Radar altimeters are provided for the pilot and copilot (fig. 2-49). The altimeters provide a continuous indication of the height of the helicopter above the surface from **0** to **1,500** feet. Altimeter indications are reliable with pitch and roll attitude **up to 45°**.

Altitude is displayed by a dial, pointer, and by a digital display. Each altimeter has HI and LO caution lights. The caution lights on each altimeter can be set independently of the other altimeter. The caution lights are set by rotating the LO SET and HI SET knobs until the L index and H index on the perimeter of the altimeter are at the desired altitudes.

When the helicopter descends below the low index setting or rises above the high index setting, the corresponding HI or LO caution light will illuminate. If helicopter altitude **exceeds 1,500** feet, pitch or roll angle **exceeds 45°**, or the system is unreliable, the following will occur. The OFF flag will appear, the pointer will move through **1,500** feet behind the dial mask, and the digital display and LO and HI caution lights will extinguish.

If power to the system is lost, the following will occur. The OFF flag will appear, the digital display and caution lights will go out, and the pointer will remain at



0145-52-10

Figure 2-49. Radar Altimeter (AN/APN-209)

the last valid indication when power was lost. The altimeters have a self-test feature. Pressing the PUSH-TO-TEST knob will cause the pointer and digital display to indicate **between 900 and 1,100** feet. If LO set and HI set are indexed **below 900** feet, the LO caution light goes out, and the HI caution light comes on. Power to operate the radar altimeter is supplied by the No. 2 DC bus through the NAV RAD ALT circuit breaker on the No. 2 PDP.

**2-199. Controls and Function, Radar Altimeter (AN/APN-209A).**

CONTROLS/ INDICATOR	FUNCTION
LO SET knob	Either pilot's LO SET knob applies power to altimeter system. LO set index on both altimeters can be set independently. Both LO set indices must be masked to turn the set off.
HI SET knob	Sets position of HI set index and tests altimeter system when pressed.

CONTROLS/ INDICATOR	FUNCTION
LO set index	Indicates altitude trip point for LO caution light.
HI set index	Indicates altitude trip point for HI caution light.
Indicator pointer	Indicates absolute altitude from 0 to 1,500 feet.
Digital indicator	Provides direct reading four digit indication of absolute altitude from 0 to 1,500 feet.
LO caution light	Comes on when helicopter descends below altitude on LO set index.
HI caution light	Light comes on when helicopter rises above altitude on HI set index.
OFF flag	Flag is displayed when power is removed from set, when indications are unreliable, or when altitude exceeds approximately 1,500 feet.

CONTROLS/ INDICATOR	FUNCTION
RAD ALT dimming controls	On right side of both instrument panels. Controls light intensity of digital display and HI and LO caution light.

**2-200. Normal Operation - Radar Altimeter (AN/APN-209A).**

a. Starting.

(1) Rotate the LO SET knob on the pilot's altimeter until the LO index is at 100 feet. Rotate the HI set knob until the HI index is at 800 feet. Allow 1 minute for warmup.

(2) Check for the following indications:

- (a) The pointers indicate between 0 and 2 feet.
- (b) The digital displays indicate between 0 and 2 feet.
- (c) LO caution light is on.
- (d) HI caution light is off.
- (e) OFF flag not in view.

b. Testing.

(1) Press and hold the PUSH-TO-TEST knob. Check for the following indications:

- (a) OFF flags not in view.
- (b) Pointers indicate between **900** feet and **1,100** feet.
- (c) Digital displays read between **900** feet and **1,100** feet.
- (d) LO caution light is off.
- (e) HI caution light is on.

(2) Release the PUSH-TO-TEST knob. Check that all indications return to those specified in step a.(2).

**NOTE**

The LO caution light may appear to go out. However, the light will be visible with night vision goggles. In bright daylight, it may be necessary to shade the indicator to verify operation of the dimming control.

(3) Rotate the RAD ALT dimming control from BRT to DIM. Check that the digital display dims and goes out. Check that the LO caution light dims but does not go out completely.

(4) Repeat on copilot's instrument.

c. Inflight operation.

**CAUTION**

**When operating over dense foliage, the radar altimeters will indicate the altitude to the tops of the trees. When operating over sparse foliage, the altimeters may indicate the altitude between the ground and about half the average tree height, depending on ground speed. When external cargo is carried, the radar altimeter may occasionally indicate the distance between the bottom of the helicopter and the load.**

(1) Set RAD ALT dimming control to desired digital display light level.

(2) Set HI and LO indexes as desired. If HI or LO indexes are not desired, set the LO index at 0 feet or the HI index above 1, 500 feet.

**2-200.1. RADAR ALTIMETER AN/APN-209( ) Altitude Voice Warning System (AVWS). (If Installed by MWO 1-1520-240-50-61)**

The RT-I 115F/APN-209 Altitude Voice Warning System (AVWS) consists of a panel mounted receiver-transmitter/height indicator (RT-1115F/APN-209) and two flush-mounted antennas. When installed, the height indicator is mounted in the pilot instrument panel.

The face of the altitude voice warning radar altimeter (RT-1115F/APN-209) is exactly the same as that of the visual only AN/APN-209A radar altimeter, with the operation being the same as outlined in section 2-198. The difference is only internal. A transmitter added internally sends out an aural warning to the pilot, copilot, and flight engineer interphone station ICS panels when the helicopter descends below the low index setting or rises above the high index setting (in addition to the LO or HI caution lights).

**NOTE**

The voice portion of the system works off a 10 second clock. If a transition is made thru either Preset, back to the original warning condition within this time frame, the voice warning will stay at its original volume level.

The volume of the aural warning message can be adjusted by the flight crew. On initial transition the volume is always set to Full. By momentarily pressing the PUSH-TO-TEST (PTT) knob once, the message is decreased to 1/2 the volume. Momentarily pressing the PTT knob a second time disables the aural warning message. Regardless of the volume level, when the aircraft transitions back through either Preset (HI or LO) (from caution light Off to On), the volume level of the aural warning message will return to Full.

**2-200.2. Controls and Function, Radar Altimeter (AN/APN-209()) (AVWS).**

CONTROLS/ INDICATOR	FUNCTION
LO SET knob	The LO SET knob applies power to altimeter system. LO set index on both pilot's altimeters can be set independently. Both LO set indexes must be masked to turn the set off.
HI SET knob	Sets position of HI set index when turned. Adjusts the warning message volume level and tests altimeter system when pressed.
LO set index	Indicates altitude trip point for LO caution light.
HI set index	Indicates altitude trip point for HI caution light
Indicator pointer	Indicates absolute altitude from 0 to 1, 500 feet.
Digital indicator	Provides direct reading four digit indication of absolute altitude from 0 to 1,500 feet.
LO caution light	Comes on when helicopter descends below altitude on LO set index.
HI caution light	Light comes on when helicopter rises above altitude on HI set index.
OFF flag	Flag is displayed when power is removed from set, when indications are unreliable, or when altitude exceeds approximately 1,500 feet.
RAD ALT dimming	On right side of both controls instrument panels. Controls light intensity of digital display and HI and LO caution light.

**2-200.3 Normal Operation - Radar Altimeter (AN/APN-209()) (AVWS).**

a. Starting.

**NOTE**

Connect monitor headset to the aircraft ICS.

**2-76 Change 6**

(1) Rotate the LO SET knob on the pilot's altimeter until the LO index is at 100 feet. Rotate the HI set knob until the HI index is at 800 feet. Allow 1 minute for warmup.

(2) Check for the following indications:

(a) The pointers indicate between **0** and **2** feet.

(b) The digital displays indicate between **0** and **2 feet**.

(c) LO caution light is on.

(d) Low altitude warning ("ALTITUDE LOW, TOO LOW") is heard in the headset.

(e) HI caution light is off.

(f) OFF flag not in view.

b. Testing.

**NOTE**

Connect monitor headset to the aircraft ICS.

(1) On the AN/APN-209( ) indicator, rotate the and tests altimeter system when LOSET knob to a point just above the OFF detent. Adjust HI SET knob to position the HI index to 100 feet. Allow 1 minute for warmup. Verify the following:

(a) The indicator pointer reads **0** to **2** feet.

(b) The digital display reads **0** to **2** feet.

(c) LO caution light is off.

(2) Verify low altitude warning ("ALTITUDE LOW, TOO LOW") is NOT heard in the headset.

(3) Adjust LO index to approximately 10 feet position on indicator. Verify the following:

(a) The LO warning lamp is illuminated.

(b) The low altitude warning, "ALTITUDE LOW, TOO LOW" is heard, clear and distinctly, in headset and at FULL volume. Audio warning repeat interval is 10 ( $\pm 1$ ) seconds. Momentarily press the PUSH- TO-TEST knob once and verify the message is at 1/2 volume. Momentarily press the PUSH-TO-TEST a second time and verify the warning message is OFF.

(c) Reset the LO index to a point just above the OFF detent. Check that system is still functional and LO warning lamp is extinguished. Wait 11 seconds before proceeding to the next step.

(4) Readjust the LO index to approximately 10 feet position on indicator. The LO warning lamp is illuminated and the low altitude warning, "ALTITUDE LOW, TOO LOW", is audible at FULL volume.

(5) Press and hold the PUSH-TO-TEST knob to actuate the PUSH-TO-TEST condition. Verify the following:

(a) OFF flags not in view.

(b) Pointers indicate between 900 feet and 1,100 feet.

(c) Digital displays read between 900 feet and 1,100 feet.

(d) LO caution light is off.

(e) HI caution light is on.

(f) The high altitude warning, "ALTITUDE HIGH, CHECK ALTITUDE", is audible (Full volume) at 10 second intervals throughout the test.

(6) Release the PUSH-TO-TEST knob. Check that all indications return to those specified in step b.(4).

#### NOTE

The LO caution light may appear to go out. However, the light will be visible with night vision goggles. In bright daylight, it may be necessary to shade the indicator to verify operation of the dimming control.

(7) Rotate the RAD ALT dimming control from BRT to DIM. Check that the digital display dims and goes out. Check that the LO caution light dims but does not go out completely.

(8) Set gain controls on the pilot, copilot, and flight engineer interphone station C-6533/ARC ICS's to the minimum (counter-clockwise) position. Repeat steps (3) thru (5). Verify that the voice warning audio is discernable in the headset at all three stations.

c. Inflight operation.

#### **CAUTION**

**When operating over dense foliage, the radar altimeters will indicate the altitude to the tops of the trees. When operating over sparse foliage, the altimeters may indicate the altitude between the ground and about half the average tree height, depending on ground speed. When extend cargo is carried, the radar altimeter may occasionally indicate the distance between the bottom of the helicopter and the load**

(1) Set RAD ALT dimming control to desired digital display light level.

(2) Set HI and LO indexes as desired. If the helicopter exceeds one of these indexes, an aural warning message will be heard at full volume initially, but the volume level can be decreased by one-half (1/2) by pressing the PUSH-TO-TEST once or inhibited by pressing PUSH-TO-TEST a second time. If HI or LO indexes are not desired, set the LO index at 0 feet or the HI index above 1,500 feet.

#### **2-201. VERTICAL SPEED Indicator.**

Two VERTICAL SPEED indicators are on the instrument panel (fig. 2-8 and 2-10). They indicate the rate of climb based on the rate of change of atmospheric pressure. The indicator is a direct-reading pressure instrument requiring no electrical power for operation.

#### **2-202. Attitude Indicator.**

Two attitude indicators are on the instrument panel (fig. 2-8 and 2-10). The attitude indicators have been specifically tailored for the flight characteristics of a helicopter by the inclusion of an electrical trim capability in the roll axis in addition to the standard pitch trim. Normal flight attitudes of helicopters, defined by fixed amounts of roll as well as pitch, are easily trimmed unto this indicator, and optimum operation of the helicopter in an attitude such as hover is facilitated. Degrees of pitch and roll are indicated by movement of a universally mounted sphere painted optical black and light gray to symbolize earth and sky, with a horizon line separating the two colors. To adjust the miniature aircraft in relation to pitch, use the lower knob. The pitch adjustment range is about 20° nose up and 20° nose down. To compensate attitude in the roll axis, use the upper knob. The roll adjustment range is about 8° minimum in either direction.

#### NOTE

Rapid rotation of the pitch and roll trim knobs on the attitude indicator may cause abrupt pitch and roll attitude changes with AFCS on.

The indicator incorporates integral lighting. The pilot and copilot attitude indicators should erect within 30 to 90 seconds after electrical power is applied. Power to operate the attitude indicator gyms is supplied by the No. 1 and No. 2 AC bus through the NAV PILOT VGI and NAV COPLT VGI circuit breakers on the No. 1 and No. 2 PDP.

#### **2-203. Pilot and Copilot Attitude Indicator (VGI) switch.**

A VGI switch is on the instrument panel below each attitude indicator (fig. 2-8 and 2-10). The switch is labeled NORM and EMER. When the switch is at

NORM, each attitude indicator operates from a separate gyro. If either the pilot or the copilot gyro fails, signaled by the OFF flag on the indicator, manual switching to the remaining gyro is accomplished by placing the respective VGI switch to EMER. The switching of the gyros from NORM to EMER operation is accomplished by a gyro transfer relay. Failure of the gyro will also result in failure of the associated AFCS. Power is supplied by the No. 2 DC bus through the NAV CONT VGI circuit breaker on the No. 2 PDP.

**2-204. Turn and Slip Indicator (4-Minute Type).**

Each turn and slip indicator (fig. 2-8 and 2-10) is controlled by an electrically actuated gyro. The instrument has a pointer (turn indicator) and a ball (slip indicator). Power to operate the gyros is supplied by the DC essential bus through the NAV TURN & SLIP circuit breakers on the No. 1 and No. 2 PDP.

**2-205. Magnetic Compass.**

The magnetic compass is mounted on top of the center instrument panel glareshield (fig. 2-4). It is a direct reading instrument requiring no electrical power. It consists of a compass card mounted on a magnetic element in a liquid-filled bowl.

**2-206. Free Air Temperature Gauge.**

The free air temperature gauge is on the exterior of the pilot's eyebrow window (fig. 2-4). The unit is calibrated in degrees from -70° to +50°C.

**2-207. CHRONOMETER.**

Two digital clocks labeled CHRONOMETER are located on the copilot and pilot instrument panels (fig. 2-50). Each clock has a six-digit GMT (greenwich mean time) display and a four-digit selectable display. A test mode is provided to check system. A flashing annunciator identifies which clock mode has been selected. There are three controls on each clock, a SELECT button, a CONTROL button, and a DIM switch.

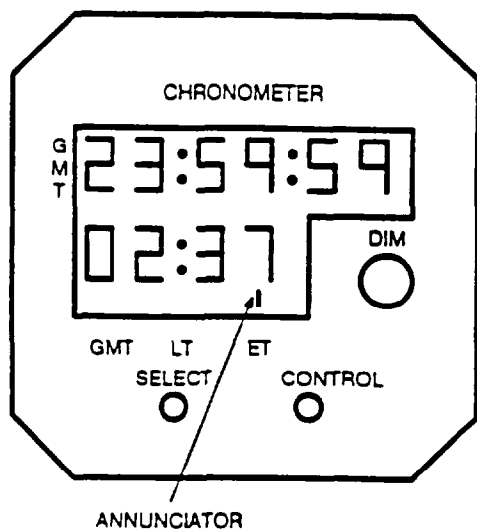


Figure 2-50. Chronometer

a. **SELECT Button.** It allows the selection of any of three modes on the four-digit display: GMT. LT (local time), or ET (elapsed time). The six-digit display shows GMT only.

b. **CONTROL Burton.** It is used to set the rime selected on the four-digit display. When the CONTROL and SELECT buttons are pressed simultaneously, the four-digit display is changed from the normal to the time set mode, and the CONTROL button is functional.

c. **DIM Control Switch.** It is used to set the light intensity of the display. At low light settings, the clock display is NVG compatible.

Integral alkaline batteries maintain clock operation when no aircraft power is applied, but the CONTROL and SELECT buttons are disabled. Power to operate the chronometers is supplied by the DC essential bus through the CPLT CLOCK and PLT CLOCK on the No. 1 PDP and No. 2 PDP.

**2-208. Normal Operation - CHRONOMETER.**

**2-209. Setting GMT.** Press the SELECT button until GMT is selected. Simultaneously press both the SELECT and CONTROL buttons to enter the set mode. The tens of hours digit will start flashing and the CONTROL button has full control of the flashing digit. Each time the CONTROL button is pressed, the flashing digit will increment. Once the tenth of hours is set, pressing the SELECT button will select the next digit to be set. After the last digit has been selected and set with the CONTROL button, press the SELECT button to exit the set mode. The annunciator will resume its normal flashing condition to indicate that the GMT clock is running.

**2-210. Setting LT.** Press the SELECT button until LT is selected. Simultaneously press both the SELECT and CONTROL buttons to enter the set mode. The tens of hours digit will start flashing and the CONTROL button has full control of the flashing digit. Use the same sequence as for setting GMT with the exception that the minutes are already synchronized with the GMT clock and can not be set when in LT mode.

**2-211. Setting ET.** The elapsed time allows for count up or count down modes.

a. **Count Up.** Press the SELECT button until ET is selected. Press the CONTROL button to start count up sequence. The clock will count up to 59 minutes, 59 seconds and then changes to hours and minutes. It will count up to 99 hours and 59 minutes. Pressing the CONTROL button again resets the ET to zero.

b. **Count Down.** Press the SELECT button until ET is selected. Simultaneously press both SELECT and CONTROL buttons to enter the set mode. A count down from any time, not to exceed 59 minutes and 59 seconds, can be set using the same sequence as for setting GMT. Once the last digit is set, pressing the SELECT button exits the set mode and the clock is ready to start count down. Pressing the CONTROL

button will start count down sequence. When the clock reaches zero, an alarm becomes active by flashing the numbers and the ET counter will begin to count up. To reset the alarm press either the SELECT or CONTROL button.

**2-212. Test Mode.** To activate the test mode, press and hold the SELECT button for three seconds and all numerical displays will show an 8 and all annunciators will be active.

**2-213. Master Caution System.**

The master caution system provides the pilots with a visual indication of helicopter conditions or faults (fig. 2-51 and 2-51.1). The components of the systems are the master caution panel with NVG filter, two MASTER CAUTION lights with NVG filters, and a CAUTION LT panel with a TEST and a BRT-DIM switch. Power to operate and control the master caution system is supplied by the DC essential bus through the LIGHTING CAUTION PNL circuit breaker on the No. 1 PDP.

**2-214. Master Caution Panel.** The master caution panel is on the center instrument panel (fig. 2-51 and

2-5 1.1). Each capsule is labeled with word segments which are related to the fault or condition. When a caution capsule illuminates, the word segments lettered into the panel are of an amber color. When they extinguish, the lettering is not readable. Tables 2-2 and 2-2.1 contain lists of the word segments displayed on the capsules and their actual meaning and cause.

An NVG filter is provided for use during NVG operations. The filter fits over the master caution panel and is secured in place by hook and pile tape at its base. When the filter is in this position, any light coming from the caution lights will be NVG compatible. For normal operations, the filter is rotated from its base to a horizontal position, and stowed in a compartment above the master caution panel.

**2-215. MASTER CAUTION Lights.** Two MASTER CAUTION lights on the instrument panels indicate that one or more of the caution capsules have illuminated. On the pilot instrument panel, the caution light is above the airspeed indicator. On the copilot instrument panel, it is above the altimeter.

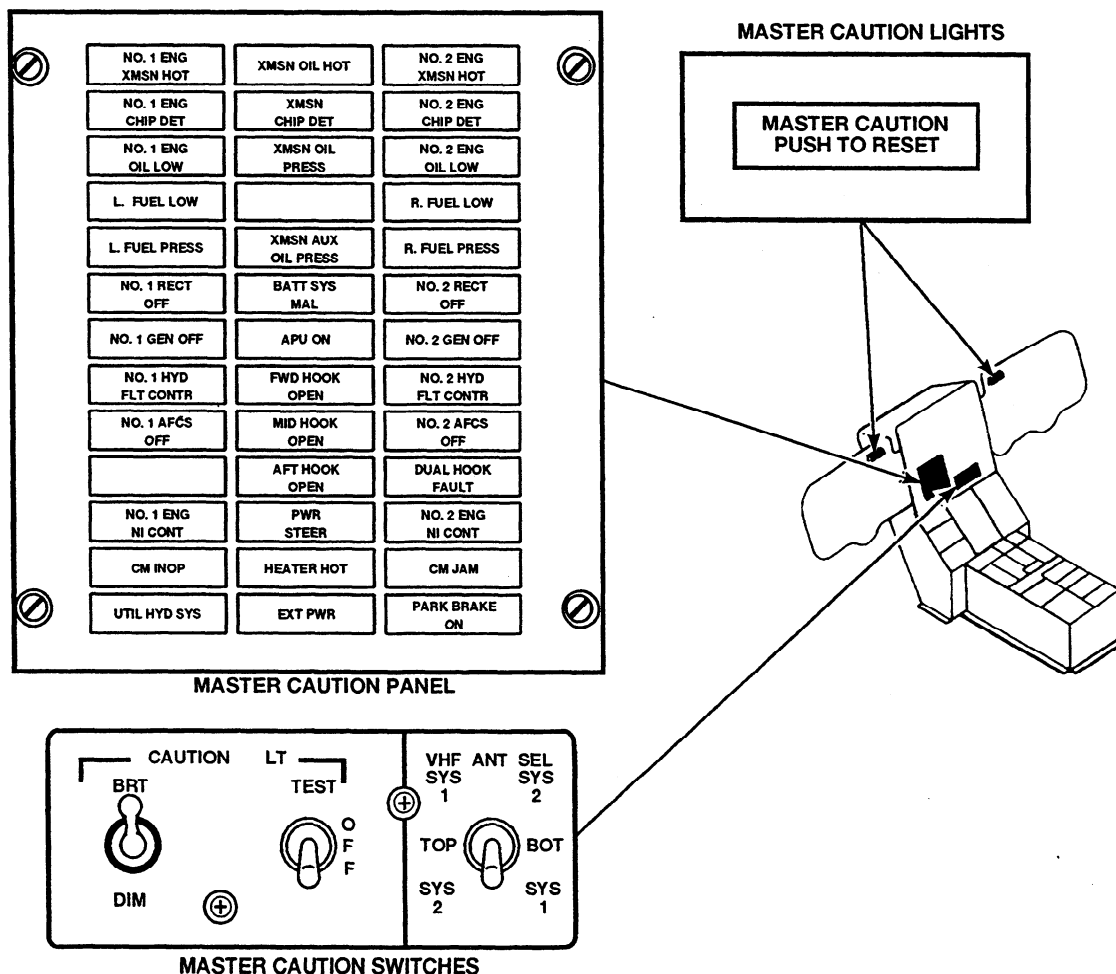


Figure 2-51. Master Caution System 712

A66987



Table 2-2. Master Caution Panel Capsules 712

WORD SEGMENT	EXPLANATION
XMSN OIL HOT	Transmission oil temperature is more than 140°C.
XMSN OIL PRESS	Transmission main oil pressure is less than 20 psi, or less than 10 psi in the aft rotor shaft.
XMSN AUX OIL PRESS	Less than 20 psi auxiliary oil pressure in the forward, or aft transmission or less than 10 psi in the combining transmission.
NO. 1 ENG OIL LOW	Approximately 2 qt of usable oil is remaining in No. 1 engine oil tank.
NO. 2 ENG OIL LOW	Approximately 2 qt of usable oil is remaining in No. 2 engine oil tank.
L FUEL PRESS	Left fuel pressure is below 10 psi.
R FUEL PRESS	Right fuel pressure is below 10 psi.
PWR STEER	Steering control has been disabled due to system malfunction or steering limits have been exceeded.
NO. 1 HYD FLT CONTR	No. 1 flight control hydraulic system pressure is below 1,800 psi.
NO. 2 HYD FLT CONTR	No. 2 flight control hydraulic system pressure is below 1,800 psi.
UTIL HYD SYS	Utility hydraulic system pressure is below 1,800 psi.
PARK BRAKE ON	Parking brake is on.
NO. 1 RECT OFF	Transformer-rectifier has failed or the generator output is interrupted.
NO. 2 RECT OFF	Transformer-rectifier has failed or the generator output is interrupted.
NO. 1 GEN OFF	No. 1 generator is inoperative or the generator switch is at OFF.
NO. 2 GEN OFF	No. 2 generator is inoperative or the generator switch is at OFF.
BATT SYS MAL	Battery or battery charging system has failed or the battery has exceeded the safe operating temperature.
EXT PWR	This light comes on whenever external power is connected to the bus.
L FUEL LOW	Left main fuel tank has approximately 20 percent of fuel remaining.
R FUEL LOW	Right main fuel tank has approximately 20 percent of fuel remaining.
HEATER HOT	Temperature within heater is greater than 177°C.
MID HOOK OPEN	The midcargo hook has been opened, either hydraulically, pneumatically, or manually.
APU ON	The APU is up to speed and can be used.
DUAL HOOK FAULT	The forward and/or aft hook circuit has an electrical fault and the hook(s) shall not be released electrically.
FWD HOOK OPEN	The forward cargo hook has been opened either electrically or manually.
AFT HOOK OPEN	The aft cargo hook has been opened either electrically or manually.
NO. 1 AFCS OFF	The No. 1 AFCS is off, failed, or DASH is reprogramming.
NO. 2 AFCS OFF	The No. 2 AFCS is off, failed, or DASH is reprogramming.
NO. 1 ENG CHIP DET	Metal chips in No. 1 engine or engine transmission oil.
NO. 2 ENG CHIP DET	Metal chips in No. 2 engine or engine transmission oil.
XMSN CHIP DET	Metal chips in the oil of the forward, combining, or aft transmissions or the aft thrust bearing.
NO. 1 ENG N1 CONT	No. 1 engine N1 component has failed or the engine condition lever or N1 actuator is not in the STOP, GND, or FLT position.
NO. 2 ENG N1 CONT	No. 2 engine N1 component has failed or engine condition lever or N1 actuator is not in the STOP, GND, or FLT position.
NO. 1 ENG XMSN HOT	No. 1 engine transmission oil temperature is above about 190°C.
NO. 2 ENG XMSN HOT	No. 2 engine transmission oil temperature is above about 190°C.
CM INOP	Countermeasures set has failed.
CM JAM	Countermeasures set has detected interference from other countermeasures sets or system is being jammed.

Movable NVG filters are attached to the instrument panels to the left of each light. For NVG operations, the filters can be rotated over the two MASTER CAUTION lights making the lights NVG compatible. After the MASTER CAUTION light has illuminated and the condition noted, the pilots should extinguish the MASTER CAUTION light by pressing (PUSH TO RESET) the face of the light. The MASTER CAUTION light is then ready to indicate a subsequent malfunction of a different system.

Once the malfunction is corrected, the affected caution capsule will extinguish. The HEATER HOT capsule is an exception (Refer to Section X). If either generator is cycled OFF then ON while another caution capsule is lit, the MASTER CAUTION light may remain illuminated after the generator comes back on and the associated GEN OFF capsule extinguishes. If this occurs, press to extinguish the MASTER CAUTION light.

CAUTION/ADVISORY			
ENG 1 FAIL	=====	=====	ENG 2 FAIL
FADEC 1	=====	ENG CONT PWR	FADEC 2
=====	REV 1	REV 2	=====
ENG 1 OIL LVL	EAPS 1 FAIL	EAPS 2 FAIL	ENG 2 OIL LVL
ENG 1 CHIP DETR	XMSN OIL HOT	XMSN CHIP DETR	ENG 2 CHIP DETR
ENG 1 XMSN HOT	=====	XMSN OIL PRESS	ENG 2 XMSN HOT
L FUEL LVL	=====	XMSN AUX OIL PRESS	R FUEL LVL
L FUEL PRESS	=====	HTR HOT	R FUEL PRESS
RECT 1	BATT SYS MALF	PWR STEER	RECT 2
GEN 1	=====	=====	GEN 2
HYD 1	CM JAM	UTIL HYD SYS	HYD 2
AFCS 1	CM INOP	DUAL HOOK FAULT	AFCS 2
=====	APU ON	EXT PWR	=====
=====	=====	FWD HOOK OPEN	=====
=====	PARK BRK ON	MID HOOK OPEN	=====
=====	=====	AFT HOOK OPEN	=====

A73387

Figure 2-51.1. Master Caution/Advisory Panel **714A**

**2-216. CAUTION LT Panel.** The CAUTION LT (caution light) panel is located on the center instrument panel (fig. 2-51). It comprises of a. BRT-DIM switch and a TEST switch.

a. *BRT-DIM Switch.* When the switch is placed to BRT, the caution capsule will light to full intensity. When moved to DIM, the caution capsules will not be as bright. When the cockpit dome lights are on white, it is not possible to dim the master caution panel. If the white dome light is selected while the caution lights are operating on DIM, the caution lights will automatically switch to BRT mode of operation.

b. *TEST Switch.* When the switch is placed to TEST, all the caution capsules on the master caution panel and the two MASTER CAUTION lights illuminate to facilitate checking the individual capsule lamps. When released to OFF, the lamps in the MASTER CAUTION lights and all the caution capsules extinguish. When the PLT INST and CPLT INST lights rotary control switches are active, and the VHF NAV and marker beacon VOL switches are on, the test feature will also light all the select legends on the MODE SELECT panel and the MKR BCN indicator lights.

**Table 2-2.1. Master Caution/Advisory Panel Capsules 714A**

<b>WORD SEGMENT</b>	<b>EXPLANATION</b>
ENG 1 FAIL	Power turbine shaft failure, N1 underspeed, or flameout. During engine start this caution is illuminated if the engine fails to start.
ENG 2 FAIL	Power turbine shaft failure, N1 underspeed, or flameout. During engine start this caution is illuminated if the engine fails to start.
FADEC 1	No. 1 PRI system hard fails.
ENG CONT PWR	PTIT is within contingency power range.
FADEC 2	No. 2 PRI system hard fails.
REV 1	No. 1 REV system hard fails.
REV 2	No. 2 REV system hard fails.
ENG 1 OIL LVL	Approximately 2 qt of usable oil is remaining in No. 1 engine oil tank.
EAPS 1 FAIL	Pressure switch within No.1 EAPS has sensed a pressure differential of 10 psi, indicating a partial blockage of inlet air.
EAPS 2 FAIL	Pressure switch within No.2 EAPS has sensed a pressure differential of 10 psi, indicating a partial blockage of inlet air.
ENG 2 OIL LVL	Approximately 2 qt of usable oil is remaining in No. 2 engine oil tank.
ENG 1 CHIP DETR	Metal chips in No. 1 engine or engine transmission oil.
XMSN OIL HOT	Transmission oil temperature is more than 140°C.
XMSN CHIP DETR	Metal chips in the oil of the forward, combining, or aft transmissions or the aft thrust bearing.
ENG 2 CHIP DETR	Metal chips in No. 2 engine or engine transmission oil.
ENG 1 XMSN HOT	No. 1 engine transmission oil temperature is above about 190°C.
XMSN OIL PRESS	Transmission main oil pressure is less than 20 psi, or less than 10 psi in the aft rotor shaft.
ENG 2 XMSN HOT	No. 2 engine transmission oil temperature is above about 190°C.
L FUEL LVL	Left main fuel tank has approximately 20 percent of fuel remaining.
XMSN AUX OIL PRESS	Less than 20 psi auxiliary oil pressure in the forward, or aft transmission or less than 10 psi in the combining transmission.
R FUEL LVL	Right main fuel tank has approximately 20 percent of fuel remaining.
L FUEL PRESS	Left fuel pressure is below 10 psi.
HTR HOT	Temperature within heater is greater than 177°C.
R FUEL PRESS	Right fuel pressure is below 10 psi.
RECT 1	Transformer-rectifier has failed or the generator output is interrupted.
BATT SYS MALF	Battery or battery charging system has failed or the battery has exceeded the safe operating temperature.
PWR STEER	Steering control has been disabled due to system malfunction or steering limits have been exceeded.
RECT 2	Transformer-rectifier has failed or the generator output is interrupted.
GEN 1	No. 1 generator is inoperative or the generator switch is at OFF.
GEN 2	No. 2 generator is inoperative or the generator switch is at OFF.
HYD 1	No. 1 flight control hydraulic system pressure is below 1,800 psi.
CM JAM	Counter measures jammer failed.
UTIL HYD SYS	Utility hydraulic system pressure is below 1,800 psi.
HYD 2	No. 2 flight control hydraulic system pressure is below 1,800 psi.
AFCS 1	The No. 1 AFCS is off, failed, or DASH is reprogramming.
CM INOP	Counter measures inoperative.
DUAL HOOK FAULT	The forward and/or aft hook circuit has an electrical fault and the hook(s) shall not be released electrically.
AFCS 2	The No. 2 AFCS is off, failed, or DASH is reprogramming.
APU ON	The APU is up to speed and can be used.
EXT PWR	This light comes on whenever external power is connected to the bus.
FWD HOOK OPEN	The forward cargo hook has been opened either electrically or manually.
PARK BRK ON	Parking brake is on.
MID HOOK OPEN	The midcargo hook has been opened, either hydraulically, pneumatically, or manually.
AFT HOOK OPEN	The aft cargo hook has been opened either electrically or manually.

## SECTION XV SERVICING, PARKING, AND MOORING

**2-217. General.**

This section contains instructions on servicing, parking, and mooring the helicopter. These instructions include only those tasks which a flight crew may be expected to perform when away from a military maintenance support activity. Diagrams and tables are provided depicting servicing points, materials, and walkways.

**2-218. Servicing.**

Safe walkway areas, no step areas, and no hand holds are depicted in Figure 2-52. Servicing points are depicted in Figure 2-53. Table 2-3 lists the approved materials, specifications and capacities. Table 2-4 lists commercial equivalents for oils.

**2-219. Fuel Types.**

The following describe the various types of fuels:

- a. Army Standard Fuels. JP-4 is the Army-designated primary fuels adopted for worldwide use.
- b. Alternate Fuels. These are JP-5, JP-8, and equivalent commercial fuels which can be used continuously without power reduction when Army standard fuel is not available. Power setting adjustments and increased maintenance may be required when an alternate fuel is used.
- c. Emergency Fuels. 100LL (Low Lead) AVGAS (aviation gasoline) is authorized for use as an emergency fuel with operation not to exceed 6 hours cumulative time.

**2-220. Use of Fuels.**

Consult TB 55-9150-200-24 for use of fuel and substitute data as applicable for turbine engine aircraft. (Refer to tables 2-3, 2-5, and 2-6).

- a. There is no special limitation on the use of Army standard or alternate fuel. Certain limitations are imposed when emergency fuels are used. For record purposes, fuel mixtures shall be identified as to the major component of the mixture.
- b. The use of kerosene fuels (JP-5 or JP-8 type) in turbine engines dictates a need for special precautions. Ground starts and air restarts at low temperature may be more difficult due to low vapor pressure.
- c. When changing from one type of authorized fuel to another - for example, JP-4 to JP-5 or JP-8- it is not necessary to drain the aircraft fuel system before adding the new fuel.
- d. Fuels having the same NATO code number are interchangeable. Jet fuels conforming to ASTM-3-1655 specification may be used when MIL-T-5624 or MIL-T-83133 fuels are

not available. This usually occurs during cross-country flights where aircraft using NATO F-44 (JP-5) are refueled with NATO F-40 (JP-4) or Commercial ASTM Type B fuels. When this occurs, engine operating characteristics may change in that lower operating temperature, slower acceleration, lower engine speed, easier starting, and shorter range may be experienced. The reverse is true when changing from F-40 (JP-4) fuel to F-44 (JP-5) or Commercial ASTM Type A-1 fuels.

**WARNING**

**To prevent fuel from spilling from the tanks, caution should be used when opening fuel caps after pressure refueling or when the aircraft has been sitting in the sun.**

**2-221. Fuel Tanks Servicing.**

The CH-47D helicopter has six fuel tanks, three tanks on each side. The tanks can be serviced through the single-point pressure refueling system or through filler ports in each tank. The single-point method of servicing is preferred. Using this method, all tanks can be filled, partially filled, or selectively filled in less than 4 minutes. Refer to table 2-3 for individual tank capacities.

**2-222. Single-Point Pressure Refueling.**

The pressure refueling control panel and nozzle receptacle are on the right side of the helicopter above the forward landing gear (fig. 2-25). The landing gear access cover must be opened to expose the panel and receptacle. A nozzle grounding adapter is located on the structure adjacent to the receptacle.

- a. Be sure the helicopter is at least **50** feet from any hangar or structure.
- b. Be sure the refueling unit is at least **10** feet from the helicopter.
- c. Electrically ground the helicopter and refueling unit as follows:
  - (1) Connect one end of ground cable to the aft landing gear eyebolt or to the jack on the right side of the fuselage at sta 115. Connect the other end to a grounding rod or ramp ground point. Be sure the cable has no broken strands and the clips are securely attached to the cable and ground points
  - (2) Be sure the fueling unit is grounded to the same ground point as the helicopter.
- d. At the cockpit overhead FUEL CONTR panel set REFUEL STA switch to ON.

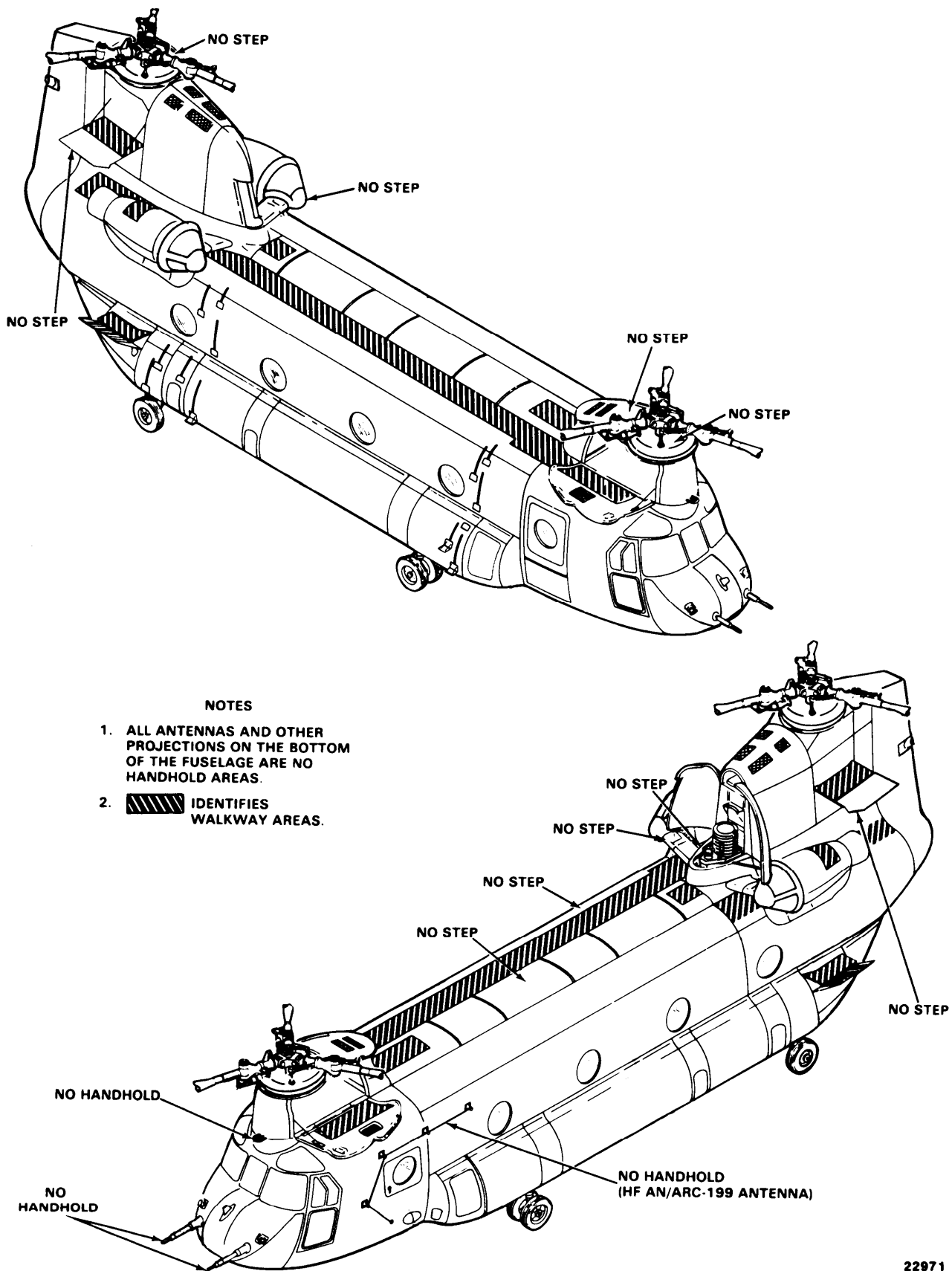
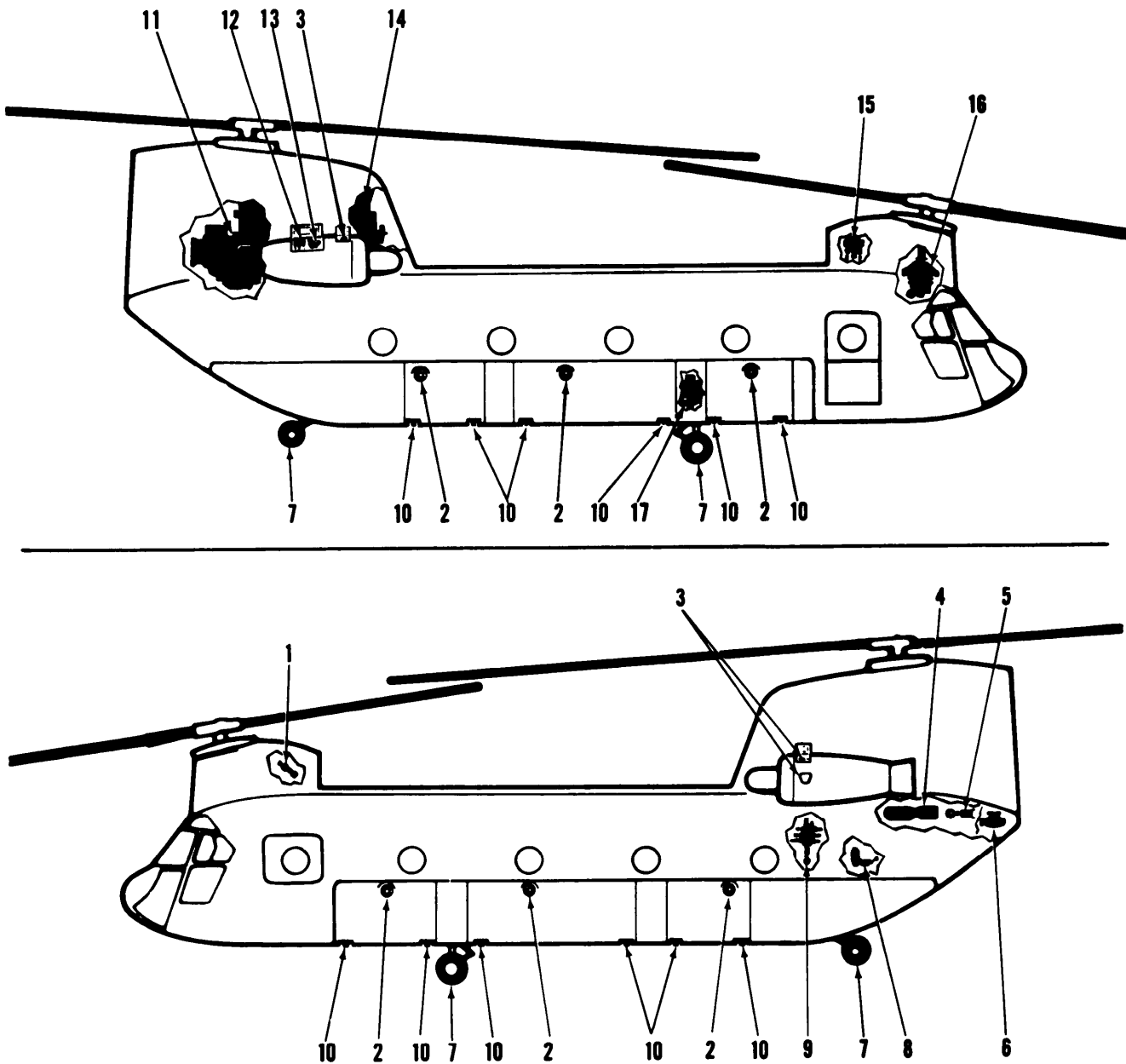


Figure 2-52. No Step, No Handhold, and Walkway Areas

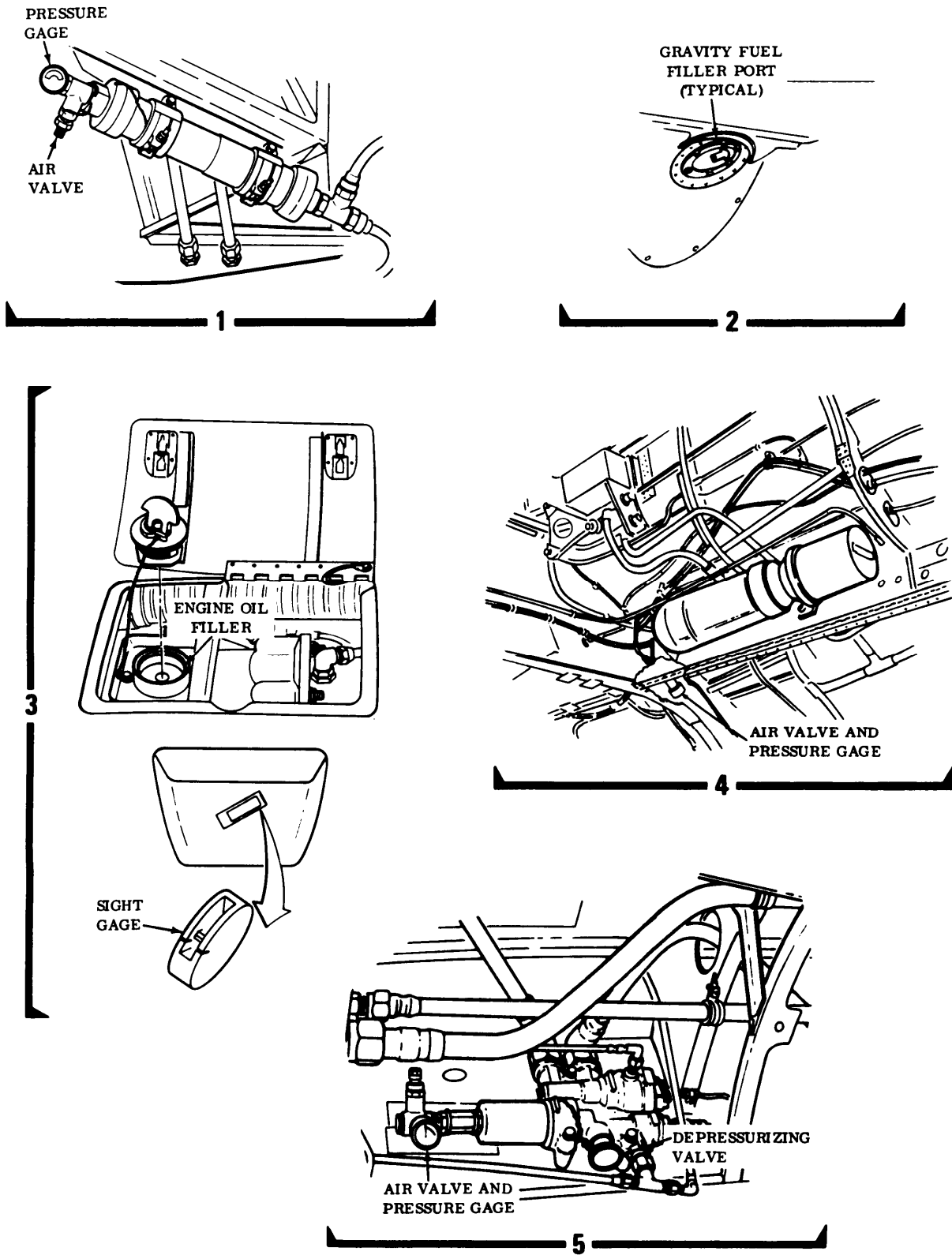
22971



22972

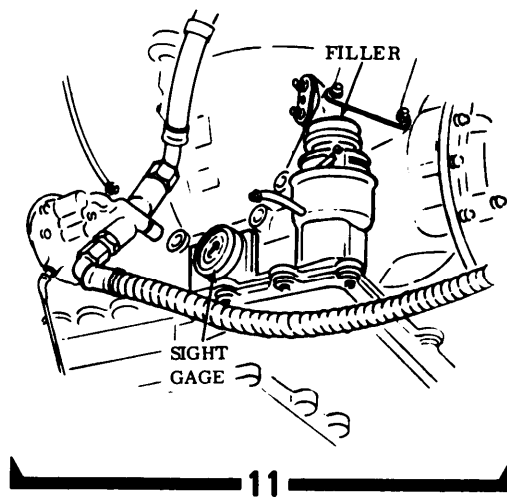
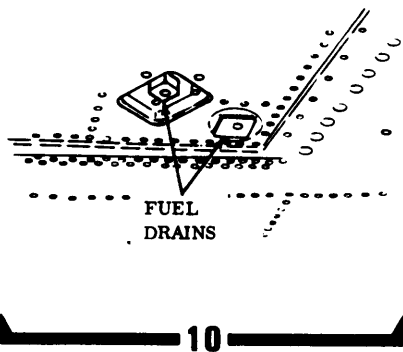
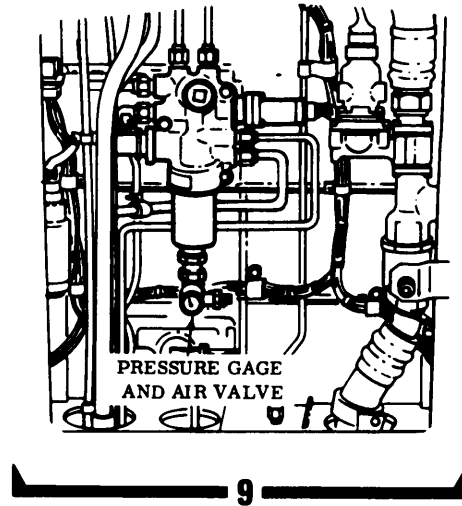
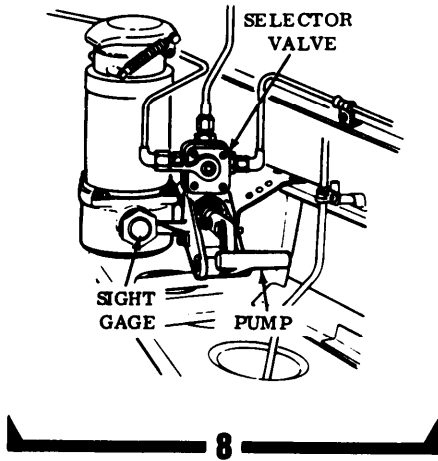
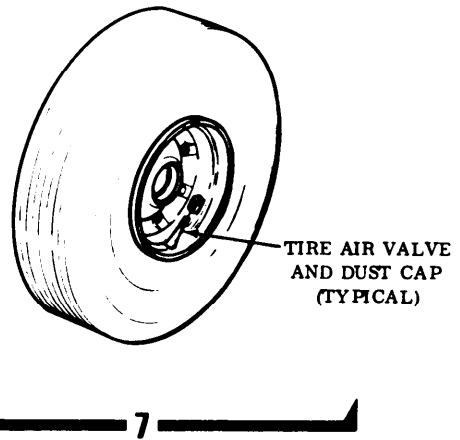
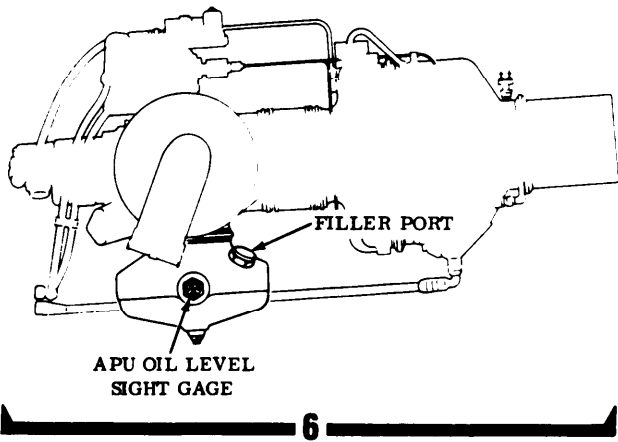
- |  |  |  |
|--|--|--|
| 1. Brake accumulator                               | 8. Hydraulic systems fill module                 | 14. Engine and combining transmission oil level indicator and filler |
| 2. Gravity fuel filler                             | 9. Power steering and swivel lock accumulator    | 15. No. 1 flight control system accumulator                          |
| 3. Engine oil level indicator and filler (Typical) | 10. Fuel tank drain valve                        | 16. Forward transmission oil level indicator and filler              |
| 4. APU start accumulator                           | 11. Aft transmission                             | 17. Pressure refueling system filler and control panel               |
| 5. APU start module accumulator                    | 12. No. 2 flight control systems accumulator     |  |
| 6. APU   | 13. Utility reservoir pressurization accumulator |  |
| 7. Tire  |  |  |

Figure 2-53. Servicing Diagram (Sheet 1 of 4)



D145-58-10(2)

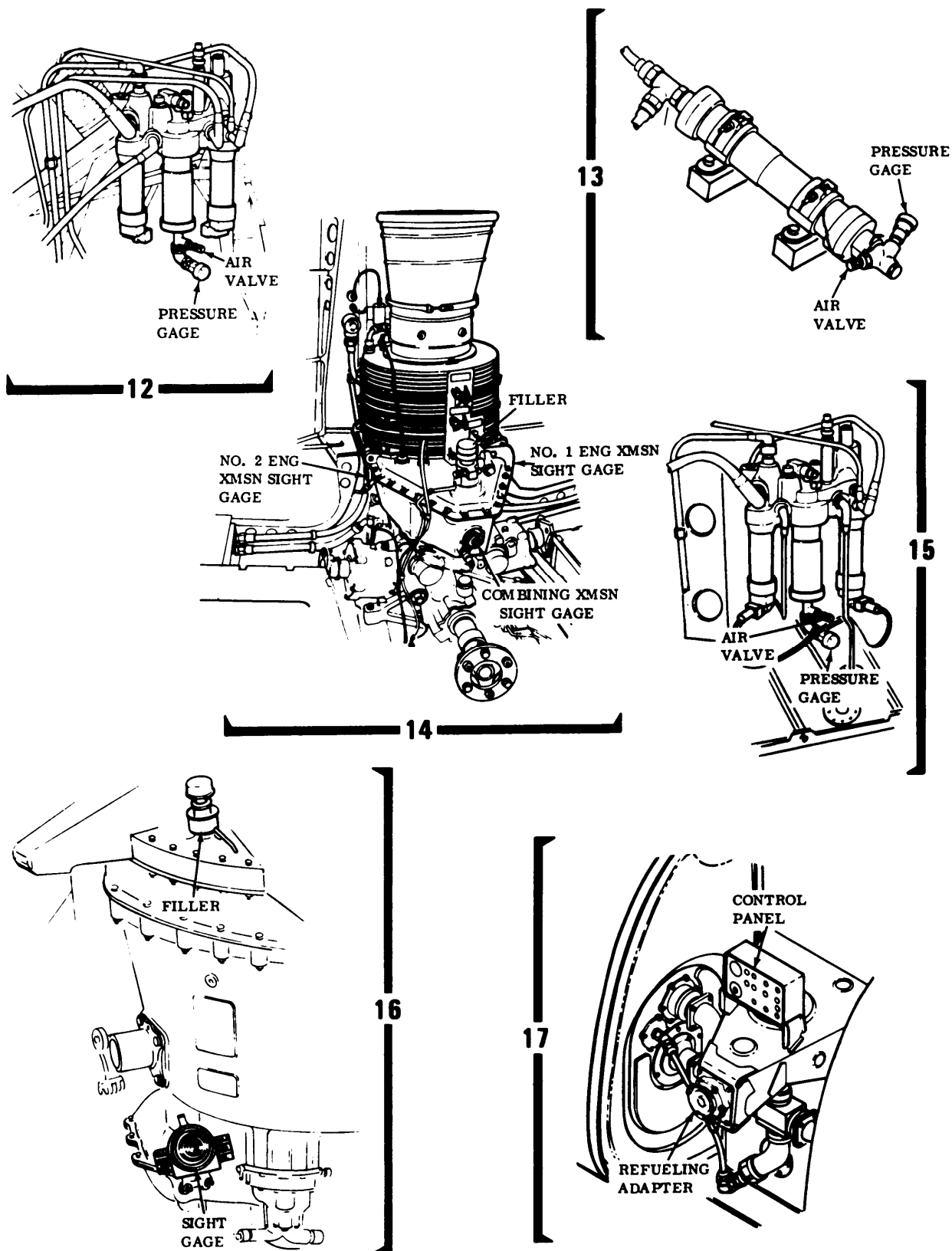
Figure 2-53. Servicing Diagram (Sheet 2 of 4)



D145-58-10(3)

Figure 2-53. Servicing Diagram (Sheet 3 of 4)





D145-58-10 (4)

Figure 2-53. Servicing Diagram (Sheet 4 of 4)

Table 2-3. Servicing

SERVICEABLE ITEM	MATERIAL	SPECIFICATION	CAPACITY (See note A)
L Main Tank	JP-4, JP-5	MIL-T-5624	278 Gallons
R Main Tank	or JP-8	MIL-T-83133	274 Gallons
L Fwd Aux Tank	JP-4, JP-5	MIL-T-5624	122 Gallons
R Fwd Aux Tank	or JP-8	MIL-T-83133	119 Gallons
L Aft Aux Tank	JP-4, JP-5	MIL-T-5624	118 Gallons
R Aft Aux Tank	or JP-8	MIL-T-83133	117 Gallons
ERFS II Tank 1, 2, or 3	JP-4, JP-5 or JP-8	MIL-T-5624 MIL-T-83133	825.5 Gallons 825.5 Gallons
Each Engine Oil Tank	Lubrication Oil	MIL-L-23699 or MIL-L-7808 (See note C)	12 Quarts
APU Engine Oil	Lubrication Oil	MIL-L-7808 or MIL-L-23699 (See note C)	3 Quarts
Forward Transmission	Lubrication Oil	DOD-L-85734 or MIL-L-23699 (See note C)	26 Quarts
Aft Transmission	Lubrication Oil	DOD-L-85734 or MIL-L-23699 (See note C)	41 Quarts
Combining Transmission	Lubrication Oil	DOD-L-85734 or MIL-L-23699 (See note C)	20 Quarts
Engine Transmission (each)	Lubrication Oil	DOD-L-85734 or MIL-L-23699 (See note C)	10 Quarts
Each Flight Control System Reservoir	Hydraulic Fluid	MIL-H-83282 (See note B)	2 Quarts
Utility Hydraulic System Reservoir	Hydraulic Fluid	MIL-H-83282 (See note B)	6 Quarts
Rotor Head Oil Tanks	Lubrication Oil	MIL-L-7808	As Required
Shock Absorbers and Landing Gear Shock Struts	Hydraulic Fluid	MIL-H-5606	As Required
Swashplates	Grease	MIL-G-81322	As Required
Tires—8.50 x 10 Type III, Forward and Aft	Air/Nitrogen		88 PSI
Accumulators	Air/Nitrogen	BB-N-411	
Apu Start			
Brakes			
Power Steering/Swivel Lock			
Signal Accumulator			
Utility Reservoir			
No. 1 and No. 2 Flight Control			

**WARNING**

Synthetic oils, such as MIL-L-23699, DOD-L-85734 and MIL-L-7808, may soften paint or stain clothing upon contact. If synthetic oil is spilled on painted surfaces, those surfaces should be cleaned immediately. Skin should be thoroughly washed after contact and saturated clothing should be removed immediately. Prolonged skin contact with synthetic oils may cause a skin rash. Areas where synthetic oils are used should have adequate ventilation to keep mist and fumes to a minimum.

- NOTES: A. These are maximum capacities which include residual and trapped oil. Servicing capacities will be less.  
 B. Hydraulic fluid MIL-H-5606 may be used when MIL-H-83282 is not available.  
 C. When FAT is below -32°C, use MIL-L-7808.

**Table 2-4. Equivalent Oils and Hydraulic Fluids**

---

**APPROVED DOMESTIC COMMERCIAL OILS FOR MIL-L-23699**

---

## Manufacturer's Designation:

PQ Turbine Lubricant 6423/6700/3889/C3788/9598  
 Brayco 8991899-G  
 Castrol 5000  
 EMGARD Synthesized Turbine Lubricant 2592/2949  
 EXXON 2380  
 ESSO Turbo Oil 2830  
 HATCOL 3211/3611/1639/1680  
 Mobil RM-139A/147A/247A/246A/249A/250A/270A  
 Royco 899/899B/899C/899HC/899E-11899E-2  
 Aeroshell Turbine Oil 500  
 Stauffer Jet II E-7603

---

**APPROVED DOMESTIC COMMERCIAL FLUIDS FOR MIL-H-5606**

---

## Manufacturer's Designation:

PQ 2890/2863/2903/2905/2950/4140/3808/4328  
 Mobil Aero HFD  
 Stauffer Aero Hydroil 500  
 Brayco 757B/756F/756ES/756E  
 Brayco Micronic 756ES  
 TEXACO Aircraft Hydraulic Oil 15/TL-1071 1  
 Chevron Aviation Hydraulic Fluid D PED 5225  
 Penreco Petrofluid 4606/4146/4607  
 Royco 756C/756D/756E  
 Castrol Hyspin A  
 Aeroshell Fluid 41

---

**APPROVED DOMESTIC COMMERCIAL FLUIDS FOR MIL-H-63282**

---

## Manufacturer's Designation:

Royco 782 E-1/782 E-2  
 Gulf TS-741  
 Brayco Micronic 882/882A  
 Royco 782/782-1/782-2  
 Aeroshell Fluid 31  
 American Oil PQ3883/4219/4401B/4627/4268/4362C/4401/4401A/4923/4908  
 Emery 2946A/2942/2857/2858  
 HATCOL 4283/4284/4285  
 Penreco Petrofluid 822

---

**APPROVED DOMESTIC COMMERCIAL FLUIDS FOR MIL-L-7808**

---

## Manufacturer's Designation:

Aeroshell Turbine Oil 308  
 American Oil PQ Turbine Oil 8365/9900/4236  
 Castrol 399  
 Brayco 880  
 EXXON Turbo Oil 2389/2391  
 HATCO 1278/1280  
 Mobil RM-272A/248A  
 Royco 808H/808HC  
 Technolube SYN TURBO No. 3

---

**Table 2-5. JP-4 Equivalent Fuel**


---

<b>JP-4 EQUIVALENT FUELS</b>	
<b>MILITARY FUEL</b>	
U.S.	JP-4 (MIL-T-5624)
NATO	F-40 (Wide cut type)
<b>COMMERCIAL FUEL (ASTM-D-1655) JET B*</b>	
American Oil Co.	American JP-4
Atlantic Richfield, Richfield Div.	Arcojet B
B.P. Trading	B.P.A.T.G.
Caltex Petroleum Corp.	Caltex Jet B
Chevron	Chevron B
Continental Oil Co.	Conoco JP-4
EXXON Co., USA	EXXON Turbo Fuel B
Gulf Oil	Gulf Jet B
Mobil Oil	Mobil Jet B
Phillips Petroleum	Philjet JP-4
Shell Oil	Aeroshell JP-4
Texaco	Texaco Avjet B
Union Oil	Union JP-4
<b>FOREIGN FUEL (F-40)</b>	
Belgium	BA-PF-2B
Canada	3GP-22F
Denmark	JP-4 MIL-T-5624
France	Air 3407 A
Germany (West)	VTL-9130-006
Greece	JP-4 MIL-T-5624
Italy	AA-M-C-1421
Netherlands	JP-4 MIL-T-5624
Norway	JP-4 MIL-T-5624
Portugal	JP-4 MIL-T-5624
Turkey	JP-4 MIL-T-5624
United Kingdom (Britain)	D. Eng RD 2454

\* Commercial fuel such as ASTM-D-1655 not containing a icing inhibitor per MIL-I-27686 (commercial name is "PRIST"). Use PRIST in accordance with instructions on the can. Anti-icing and Biocidal Additive for Commercial Turbine Engine Fuel - The fuel system icing inhibitor shall conform to MIL-L-27686. The additive provides anti-icing protection and also functions as a biocide to kill microbial growths in helicopter fuel systems. Icing inhibitor conforming to MIL-I-27686 shall be added to commercial fuel not containing an icing inhibitor during refueling operations, regardless of ambient temperatures. Refueling operations shall be accomplished in accordance with accepted commercial procedures. Commercial product PRIST conforms to MIL-I-27686.

---

**Table 2-6. JP-5 and JP-8 Equivalent Fuel**

<b>JP-5 AND JP-8 Equivalent FUELS</b>		
<b>MILITARY FUEL</b>		
U.S.	JP-5 (MIL-T-5624)	JP-8 (MIL-T-83133)
NATO	F-44	F-34
<b>COMMERCIAL FUELS (ASTM-D-1655) JET A/JET A-1*</b>		
American Oil Co.	American type A	
Atlantic Richfield	ArcoJet A	Arcojet A-1
Richfield Div.	Richfield A	Richfield A-1
B.P. Trading		B.P.A.T.K.
Caltex Petroleum Corp.		Caltex Jet A-1
Chevron	Chevron A-50	Chevron A-1
Cities Service Co.	CITGO A	
Continental Oil Co.	Conoco Jet-50	Conoco Jet-60
EXXON Co., USA	EXXON A	EXXON A-1
Gulf Oil	Gulf Jet A	Gulf Jet A-1
Mobil Oil	Mobil Jet A	Mobil Jet A-1
Phillips Petroleum	Phillijet A-SO	
Shell Oil	Aeroshell 640	Aeroshell 650
Sinclair	Superjet A	Superjet A-1
Standard Oil Co.	Jet A Kerosene	Jet A-1 Kerosene
Texaco	Avjet A	Avjet A-1
Union Oil	76 Turbine Fuel	
<b>FOREIGN FUELS (NATO F-44)</b>		
Canada		3-GP-24e
West Germany		UTL-9130-007/UTL-9130-010
Italy		AMC-143
Netherlands		D. Eng RD 2493
United Kingdom (Britain)		D. Eng RD 2498

\* Commercial fuel such as ASTM-D-1655 not containing a icing inhibitor per MIL-I-27686 (commercial name is "PRIST"). Use PRIST in accordance with instructions on the can. Anti-icing and Biocidal Additive for Commercial Turbine Engine Fuel - The fuel system icing inhibitor shall conform to MIL-L-27686. The additive provides anti-icing protection and also functions as a biocide to kill microbial growths in helicopter fuel systems. Icing inhibitor conforming to MIL-I-27686 shall be added to commercial fuel not containing an icing inhibitor during refueling operations, regardless of ambient temperatures. Refueling operations shall be accomplished in accordance with accepted commercial procedures. Commercial product PRIST conforms to MIL-I-27686.

**CAUTION**

**Be sure the fueling station fuel quantity indicator is operating before pressure fueling. If the indicator is not operating, the fuel shutoff valves cannot be checked properly and fuel cell overpressurization may result.**

e. Open the right forward landing gear access panel and perform the following check:

(1) Set the PWR switch to ON. Check that both REFUEL VALVE POSN lights momentarily illuminate, then extinguish. If either light illuminates and does not extinguish, the associated refueling valve has failed and fuel will not flow into that aft auxiliary tank. If the fuel in this tank is required to complete the mission, notify maintenance.

(2) If required, set the LIGHT switch to ON.

(3) Set the FUEL QUANTITY selector switch to TOTAL.

(4) Set the ALL TEST switch to PRI OFF.

(5) Connect the grounding wire to the grounding receptacle and connect the fueling nozzle to the adapter.

**CAUTION**

**If either the primary or secondary float switch for any tank is inoperative, do not pressure refuel that tank unless the fuel cap is removed to prevent possible fuel cell overpressurization. If both switches are inoperative, do not pressure refuel the helicopter. In addition, if both float switches are inoperative for either main tank, the system must be repaired before flight to prevent fuel cell overpressure.**

(6) Open the flow control valve on the nozzle. Check that fuel flow stops within 4 seconds. A small amount of fuel will continue to flow through the open secondary ports.

(7) Set the ALL TEST switch to SEC OFF. Check that fuel flow stops within 4 seconds. A small amount of fuel will continue to flow through the open primary ports.

f. If all tanks are to be filled, set the ALL TEST switch to FLOW. All tanks will now fill independently. Rotate the FUEL QUANTITY selector switch, checking each tank for proper fill and quantity. Shutoff valves in each tank will close and stop fuel flow as each tank fills.

g. When refueling is complete, close the flow control valve.

h. If tanks are to be partially or selectively filled, be sure to perform steps e.(6) and e.(7), then proceed as follows:

(1) Set the six FUEL CELL SHUTOFF VALVE TEST switches to PRI OFF.

(2) Set the ALL TEST switch to FLOW.

(3) Rotate the FUEL QUANTITY selector switch to the tank to be filled. The indicator pointer will indicate tank fuel quantity.

(4) Set the FUEL CELL SHUTOFF VALVE TEST switch of the tank to be filled to FLOW.

(5) Open the flow control valve.

(6) When the desired fuel level is reached, set the FUEL CELL SHUTOFF VALVE TEST switch to PRI OFF.

(7) Repeat steps (3), (4), and (6) on each tank until the desired amount of fuel is in each tank.

(8) Close the flow control valve and disconnect the nozzle and ground cable.

i. Set the PWR switch to OFF. Check that the REFUEL VALVE POSN lights momentarily illuminate, then extinguish. If either light does not illuminate on, then extinguish, the fuel in that aft auxiliary tank is unusable. Notify maintenance.

j. Close the landing gear access door.

k. Remove ground cables from the helicopter.

l. Set the REFUEL STA switch on the FUEL CONTR overhead panel to OFF.

**CAUTION**

**Perform steps m., n., and o. if helicopter will not be operated immediately. Failure to do so could result in refuel manifold seepage caused by fuel expansion.**

m. APU – Start (refer to Chapter 8). Place APU GEN switch to ON or apply AC external power.

n. Operate the forward boost pump on either main tank for **about two** minutes.

o. Place APU GEN switch to OFF, APU switch to OFF, or disconnect the external power.

**2-223. Gravity Refueling.** Perform the following steps:

a. Be sure the helicopter is at least **50** feet from any hangar or structure.

b. Be sure the fueling vehicle is at least **10** feet from the helicopter.

c. Electrically ground the helicopter as follows:

(1) Connect one end of an approved ground cable to the aft landing gear eyebolt or to one of the jacks on the side of the fuselage. Grounding jacks are located at sta. 115 on the RH side and sta. 530 on the LH side in the fuselage skin. Connect the other end to a grounding rod or ramp ground point. Make sure the cable has no broken strands and the clips are securely attached to the cable and ground points.

(2) Make sure the fueling unit is grounded to the same ground rod or ground point as the helicopter.

(3) Before opening the filler cap, ground the nozzle to the ground jack directly above the fuel tank filler.

d. When the fuel is at the desired level, remove the nozzle. Secure the filler cap. Then, disconnect the nozzle ground wire.

e. Remove the ground connection. If the helicopter is to remain parked, do not disconnect the helicopter ground.

### 2-223.1. ERFS II Refueling.

Refueling the ERFS II tanks is performed by either single point pressure refueling or gravity refueling.

#### WARNING

**The manually operated fuel/defuel vent valve on each tank must be placed in the closed position following pressure refueling. Failure to do so could permit significant fuel leakage in the event of a crash and the vent self-sealing breakaway valve fails to actuate.**

#### CAUTION

**If the fuel/vent valve is not opened, the tank cannot be pressure refueled.**

a. Single Point Pressure Refueling. The ERFS II tanks are single point pressure refueled from a connection at the motorized gate valve. The motorized gate valve must be open to pressure refuel and is controlled by the refuel valve switch on the ERFS II fuel control panel located on the forward most ERFS II tank installed. The fuel transfer hose is connected to the forward interconnecting ERFS II fuel manifold. Fuel from the transfer hose passes through the breakaway valve and the manual fuel/defuel valve to the lower fuel/shutoff valve in the tank bottom.

#### CAUTION

**The operator must exercise caution to avoid ERFS II tank overflow during gravity refueling. There is no automatic fuel flow shutoff.**

b. Gravity Refueling. If pressure refueling of ERFS II tanks is not performed or prevented, each tank can also be gravity filled through the gravity filler opening on the top of each tank. To gravity fill, the crashworthy filler cap is removed and external fuel source nozzle is inserted and the tank is filled. Low pressure flow rates must be maintained as venting of vapors bypass the filler opening and the fuel/defuel vent valve is closed during this operation. Because fuel is not entering the tank through the fuel/defuel line, the high level shutoff valve has no effect stopping the fuel flow into the tank.

### 2-223.2. Single Point Pressure Remodeling.

a. Electrical ground – Connect electrical ground from refueling aircraft. Check that the ground wire from each ERFS II tank is connected to an aircraft ground receptacle.

b. Fuel hose from refueling source – Connect to aircraft single-point pressure refueling connection.

c. Single-Point Pressure Refueling Hose Assembly – Unisex valve at the ERFS II tank – OPEN.

d. Manual FUEL/DEFUEL VALVE at each tank assembly – OPEN.

e. REFUEL STA switch located on the overhead FUEL CONTR Panel – ON.

f. REFUEL VALVE switch on the ERFS II Fuel Control Panel OPEN. IN TRANSIT light will briefly illuminate.

g. Refuel the ERFS II tanks. Fuel flow will automatically stop when tanks are full.

h. FUEL QUANTITY switch – Set to 1, 2, 3, and TOTAL to confirm tanks and system contain desired fuel quantities.

i. REFUEL VALVE switch – CLOSE. IN TRANSIT light will briefly illuminate.

#### WARNING

**The manually operated fuel/defuel valve must be placed in the closed position following pressure refueling. Failure to do so could permit significant fuel leakage in the event of a crash and the vent self-sealing breakaway valve fails to actuate.**

j. Manual FUEL/VENT VALVE at each tank assembly – CLOSED.

k. Single-Point Pressure Refueling Hose Assembly – Unisex valve at the ERFS II tank – CLOSE.

l. Fuel hose from refueling source – Disconnect from aircraft single-point pressure refueling connection.

m. Electrical ground – Disconnect electrical ground from refueling source to the aircraft.

### 2-223.3. Gravity Refueling.

a. Electrical ground – Connect electrical ground from refueling source to aircraft.

b. Grounding Cable on each ERFS II tank – Check connection security.

c. Filler Cap – Remove.

d. Service tank.

#### CAUTION

**The operator must exercise caution to avoid ERFS II tank overflow during gravity refueling. There is no automatic fuel flow shutoff.**

e. FUEL QUANTITY switch – Set to 1, 2, 3, TOTAL to confirm tanks and system contain desired fuel quantities. (Will indicate only when aircraft power is applied).

f. Filler Cap – Replace.

g. Electrical ground – Disconnect electrical ground from refueling source to aircraft.

**2-223.4. Fuel Transfer.** Fuel transfer from the ERFS II tanks to the helicopter's main tanks is accomplished through the use of dual centrifugal pumps in each ERFS II tank. During fuel transfer, the manually operated fuel/defuel valve on each tank must be closed to prevent fuel circulation inside the tank. With the fuel/defuel valve

closed, fuel is pumped into the fuel manifold at a rate of approximately 20 gpm. Fuel is delivered by the fuel manifold to the helicopter.



main fuel tanks through the aircraft fuel system quick disconnect fittings in the left and right side cargo compartment at STA 380. During transfer, the roll-over vent valve in each ERFS II tank allows venting and equalization of tank pressure above 5 psi from thermal expansion, contraction, and barometric pressure changes in the bladders. The high level fuel shutoff valves in the tanks prevent overfilling. The metallic float and ball in the roll-over vent valve prevents fuel from escaping should the tank become inverted in a roll-over and prevents slosh from uncoordinated flight from leaking to the overboard vent lines. To transfer fuel from the FARE system, fuel is pumped from the ERFS II tanks by the FARE pump. The manually operated fuel/defuel valve must be in the open position for the FARE transfer.

### 2-224. Engine Oil System.

The engine oil tank and oil quantity indicator are an integral part of the engine (fig. 2-53). Service either engine oil system as follows:

- a. If the engine has not been operated in the preceding **24** hours and the oil level is low, run it and then recheck the oil level. Otherwise, an inaccurate oil level may be indicated.
- b. Check oil level by looking through the grilled opening on the left side of the engine cowling at the 9 o'clock position.
- c. If the indicator shows less than full, open the oil filler access panel on the forward top side of the engine cover.
- d. Refer to DA Form 2408-13 and table 2-3 for the type of oil to use. Under normal conditions, engines shall be serviced with one type of oil only. If one type of oil is in an engine and that oil is not available, the other type may be used in an emergency.
- e. Remove the filler cap. Fill the tank with oil until the indicator shows full. Do not overfill tank.
- f. Install the filler cap. Close both access panels.

### 2-225. APU Oil System.

Service the APU as follows:

#### CAUTION

**Do not use the APU drip pan as a handhold. Damage to equipment will result.**

- a. Remove the filler cap from the left side of the APU (fig. 2-53).

#### CAUTION

**Do not overfill. Damage to the APU can result from overfilling.**

- b. Add oil to the APU oil tank until the level reaches the FULL mark on the sight gage. Under normal conditions, the APU shall be serviced with one type of oil only. If one type of oil is in an APU and that oil is not available, the other type may be used in an emergency.
- c. Reinstall and check security of the filler cap.

### 2-226. Transmission Oil System.

Service the forward transmission, engine/combining transmission, and aft transmission as follows:

- a. Access to oil filler and location of sight gage of each transmission (fig. 2-53) are as follows:

- (1) The oil filler and sight gage for forward transmission are accessible within the hinged fairing on the right side of the forward pylon. The filler neck is in the top forward area of the transmission. The sight gage is located in the bottom area below the filler neck; it can be viewed from above and can also be seen through a viewing port in the canted bulkhead at sta. 95 above the pilots seat.

- (2) The oil filler and sight gage for aft transmission is on forward right side of the transmission sump. It is accessible from the cargo ramp area.

- (3) The common oil filler for the combining transmission and both engine transmissions is on the combining transmission oil tank. It is accessible within the fairing of aft pylon leading edge.

- b. Refer to DA Form 2408-13 and table 2-3 for the type of oil to use. Under normal conditions, the transmissions shall be serviced with one type of oil only. If one type of oil is in a transmission and that oil is not available, the other type may be used in an emergency.

#### NOTE

To prevent overfilling the forward, aft, and engine/combining transmissions, check oil level within 30 minutes of shutdown. If the transmissions have been shut down for more than 30 minutes, run the helicopter for a minimum of 5 minutes to verify oil level before servicing.

#### NOTE

To prevent overfilling the forward and aft transmission, check oil level after the aircraft has been shut down for 30 minutes.

- c. Fill the forward transmission, engine/combining and aft transmissions to the FULL mark next to each sight gage.

### 2-227. Hydraulic Systems Servicing.

**2-228. Hydraulic Systems Fluid Servicing.** The utility systems and both flight control hydraulic systems are serviced by a common fill module on the right side of the helicopter above the ramp (fig. 2-53). The fluid level indicators are on the MAINTENANCE PANEL above the fill module. One indicator is for both flight control hydraulic systems. The other indicator is for the utility system. Direct level checks can also be made from the reservoir piston rods. Service any system as follows:

- a. Check the sight gage on the fill module reservoir for fluid level. If fluid cannot be seen on the sight gage, fill the reservoir.
- b. Check the fluid level in the flight control reservoirs by selecting each system at the FLT CONTR switch on the MAINTENANCE PANEL. Then press the LEVEL CHECK

CHECK switch. Check the fluid level in the utility reservoir by pressing the LEVEL CHECK switch.

c. Turn the system select valve to the position for the system to be serviced.

d. Using the handpump on the fill module, pump fluid into the system until the fluid in the reservoir is at the FULL mark. Keep the sight gage on the fill module full of fluid by adding fluid to the reservoir as required.

e. Turn the system select valve to OFF.

### 2-229. Hydraulic Systems Accumulator Precharge.

Figure 2-54 depicts the relationship between proper accumulator precharge and ambient temperature. To check that an accumulator is properly precharged, read free air temperature from the FAT gage. Enter the bottom of the chart at the indicated temperature and move vertically to the pressure indicated on the accumulator pressure gage. If the indicated pressure is within the minimum and maximum limits, the accumulator is properly precharged. If the indicated pressure is not within limits, refer to TM 55-1520-240-23 to service the accumulator.

**2-230. Flight Controls Hydraulic Systems Accumulators.** The No. 1 flight control system accumulator is within the forward transmission fairing, on the right side. The No. 2 system accumulator is within the aft pylon, on the right side. Determine either accumulator precharge as follows:

- a. Access to the respective accumulator.
- b. Note precharge on accumulator and ensure is within limits as per figure 2-54.
- c. If servicing is required, refer to TM 55-1520-240-23.

**2-231. Utility System Accumulators.** There are five accumulators in the utility hydraulic system. They provide pressure to start the APU, operate the power brakes and swivel locks, and maintain line pressure throughout the system.

a. The APU start accumulator is the largest in the helicopter. It is mounted overhead in the cabin at the right of the aft transmission sump. The APU start module accumulator is located aft and to the right of the APU start accumulator. The utility reservoir pressurization (bootstrap) accumulator is located forward of the No. 2 flight control accumulator in the aft pylon, accessible through the pylon right access panel. Determine accumulators precharge as follows:

- (1) Repressurize the accumulator by turning the handle on the UTILITY RESERVOIR RE-PRESSURIZE valve to OPEN. The valve is on the right side of the cabin, in the cargo ramp area.
- (2) Press and hold the depressurization valve on the APU start module accumulator until system pressure is depleted. When the accumulator has been repressurized, return the handle of the UTILITY RESERVOIR RE-PRESSURIZE valve to NORMAL.

(3) Note precharge on accumulators and ensure is within limits as per figure 2-54.

(4) If servicing is required, refer to TM 55-1520-240-23.

b. The power steering and swivel lock accumulator is located on the right side of the cabin, in the cargo ramp area. Determine accumulator precharge as follows:

#### NOTE

An alternate method is to apply external power to the helicopter and cycling the STEERING CONTROL SWIVEL STEER switch on the center console from LOCK to UNLOCK several times.

(1) Repressurize the accumulator by starting the APU and placing the APU GEN switch to ON.

(2) Place the HYD BRK STEER isolation switch on the overhead switch panel to OFF. Cycle the STEERING CONTROL SWIVEL STEER switch on the center console from LOCK to UNLOCK approximately six times.

(3) Note precharge on accumulator and ensure precharge is within limits as per figure 2-54.

(4) If servicing is required, refer to TM 55-1520-240-23.

c. The brake accumulator is located within the aft left side of the forward transmission fairing. Determine accumulator precharge as follows:

(1) Repressurize the accumulator by pressing the brakes approximately four times or until it becomes hard to apply the brakes.

(2) Accumulator precharge should read between **600 to 850** psi.

(3) If servicing is required refer to TM 55-1520-240-23.

### 2-232. Ground Handling (Towing).

Refer to TM 55-1520-240-23.

### 2-233. Parking.

Park the helicopter as directed in the following steps:

- a. Apply wheel brakes. Then, set the parking brakes.
- b. Place chocks as required.

#### CAUTION

**Failure to position blades properly can allow a blade to hit the fuselage. This may damage the fuselage and blade.**

c. Position rotary-wing blades 30° off centerline of helicopter.

d. Unplug the battery after the last flight of the day.

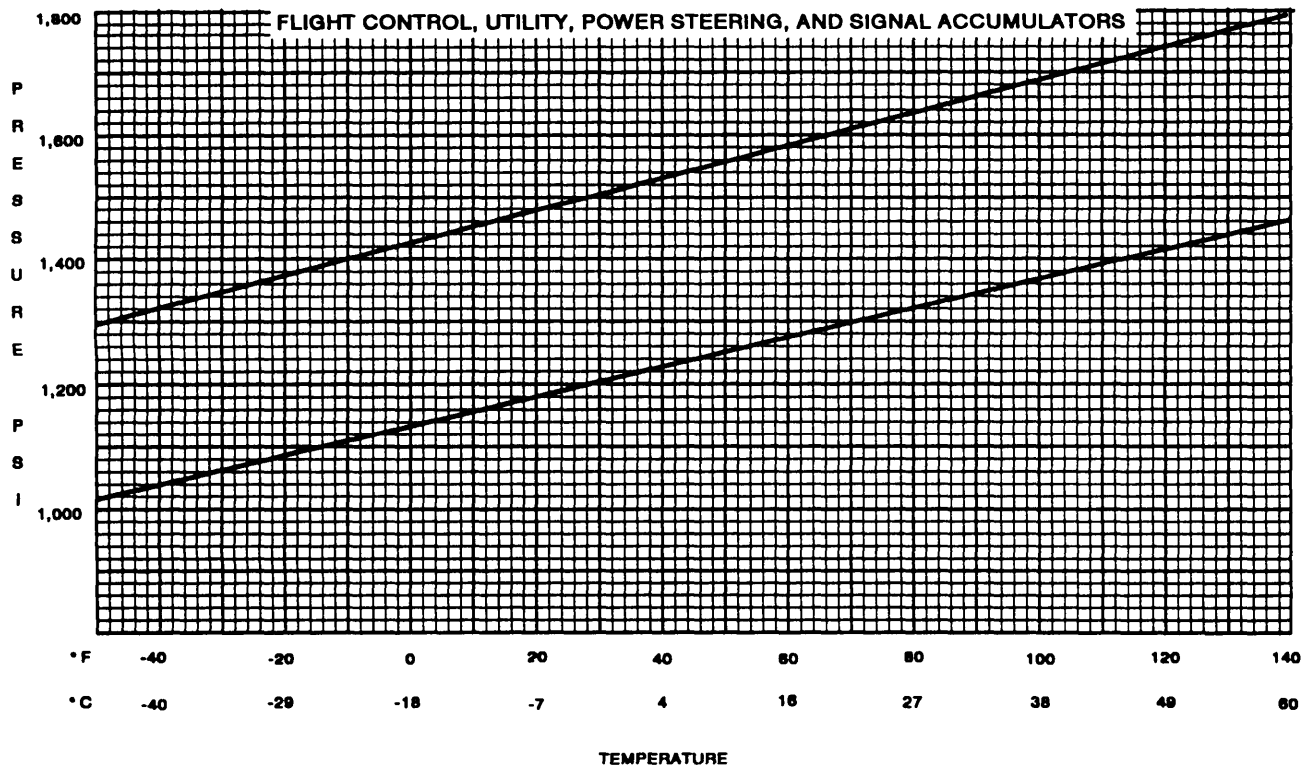
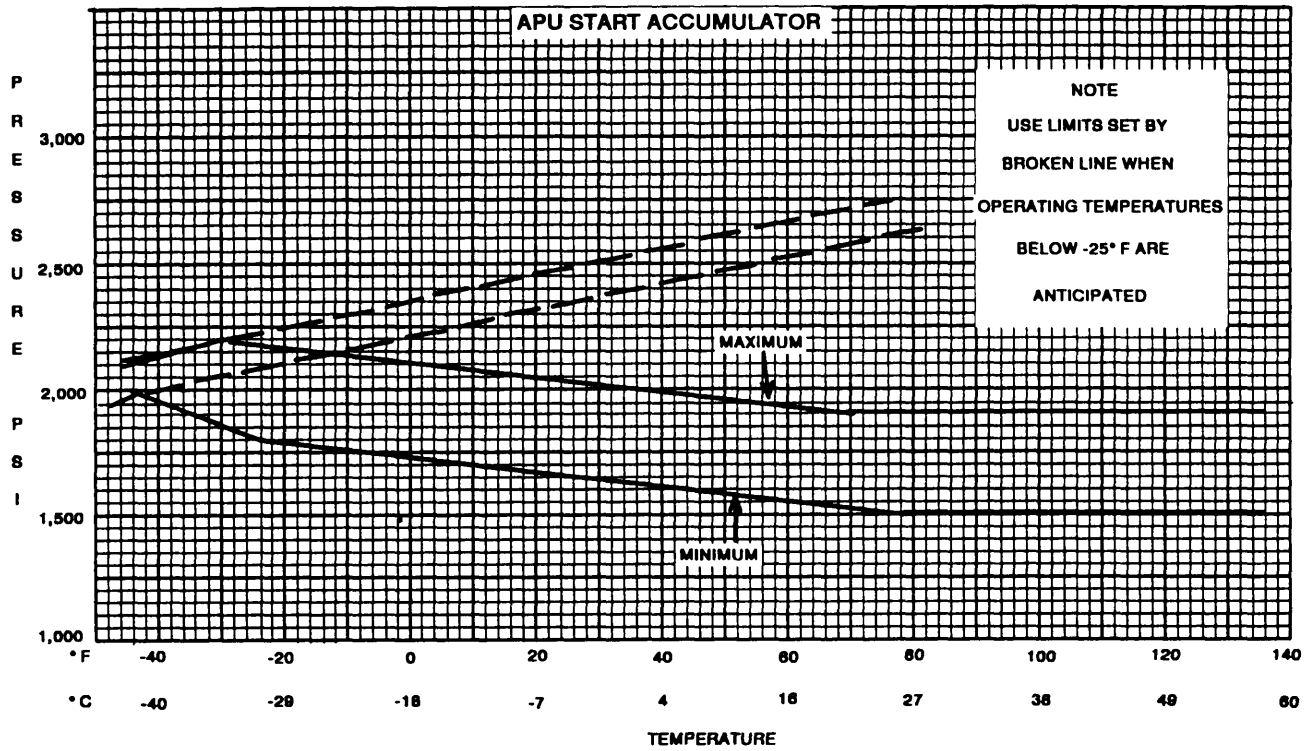


Figure 2-54. Accumulators Precharge Limits

## TM 55-1520-240-10

- e. Lock all doors and hatches.
- f. Moor the helicopter (refer to TM 1-1500-250-23).

### 2-234. Mooring.

Refer to TM 1-1500-250-23. The methods of mooring vary with intensity of winds. Table 2-7 provides necessary precautions to be taken pertaining to these conditions.

**Table 2-7. Mooring Data**

WIND SPEED	TIEDOWN REQUIREMENT
0 to 39 mph	Two forward blades tied down.
39 to 65 mph	Fuselage and blades tied down.
Over 65 mph	Evacuate helicopter from the area or store helicopter in hangar.

### 2-235. Protective Covers.

The following protective covers should be stowed in the helicopter (fig. 2-55). They are used as necessary whenever helicopter is parked or moored.

- a. Engine (LH) inlet cover.
- b. Engine (RH) inlet cover.
- c. Engine outlet cover (2 ea).
- d. Hydraulic cooler exhaust cover.
- e. Pitot tube covers (2 ea).
- f. Aft transmission cooler and APU exhaust cover.
- g. Transmission and hydraulic cooler intake.
- h. Transmission and hydraulic cooler exhaust (LH and RH).
- i. Transmission and hydraulic cooler inlet (aft pylon).
- j. Cockpit enclosure protective cover.

- k. Rotor hub protective cover (2 ea).
- l. Heater exhaust protective cover.
- m. Heater inlet cover.

### 2-236. Helicopter Security (Typical).

The helicopter is equipped with door lock security devices (fig. 2-56). These devices prevent interior access to the helicopter by unauthorized persons. Install the devices as follows:

- a. Make sure the ramp is full up. Install the cable hook through the ramp controls access door latch. Secure the fastener to the bracket. Make sure the warning streamer is visible.
- b. Close the lower rescue hatch door. If the door cannot be closed, secure the utility hatch to a tiedown ring with a cargo strap.
- c. Secure the release straps of the two cabin escape hatches and the cargo door escape hatch with restraining clamps. Make sure the clamps are located as close to the release grommet as possible. Make sure the warning streamers are readily visible.
- d. Install lock pins through the pilot's and copilot's window latches. Then, insert the quick-release pin through the bracket on the floor and into the door latch plate. Make sure the warning streamers are readily visible.
- e. Install left forward latchable escape hatch cover.
- f. Close the cabin doors. Install the bracket with the padlock.

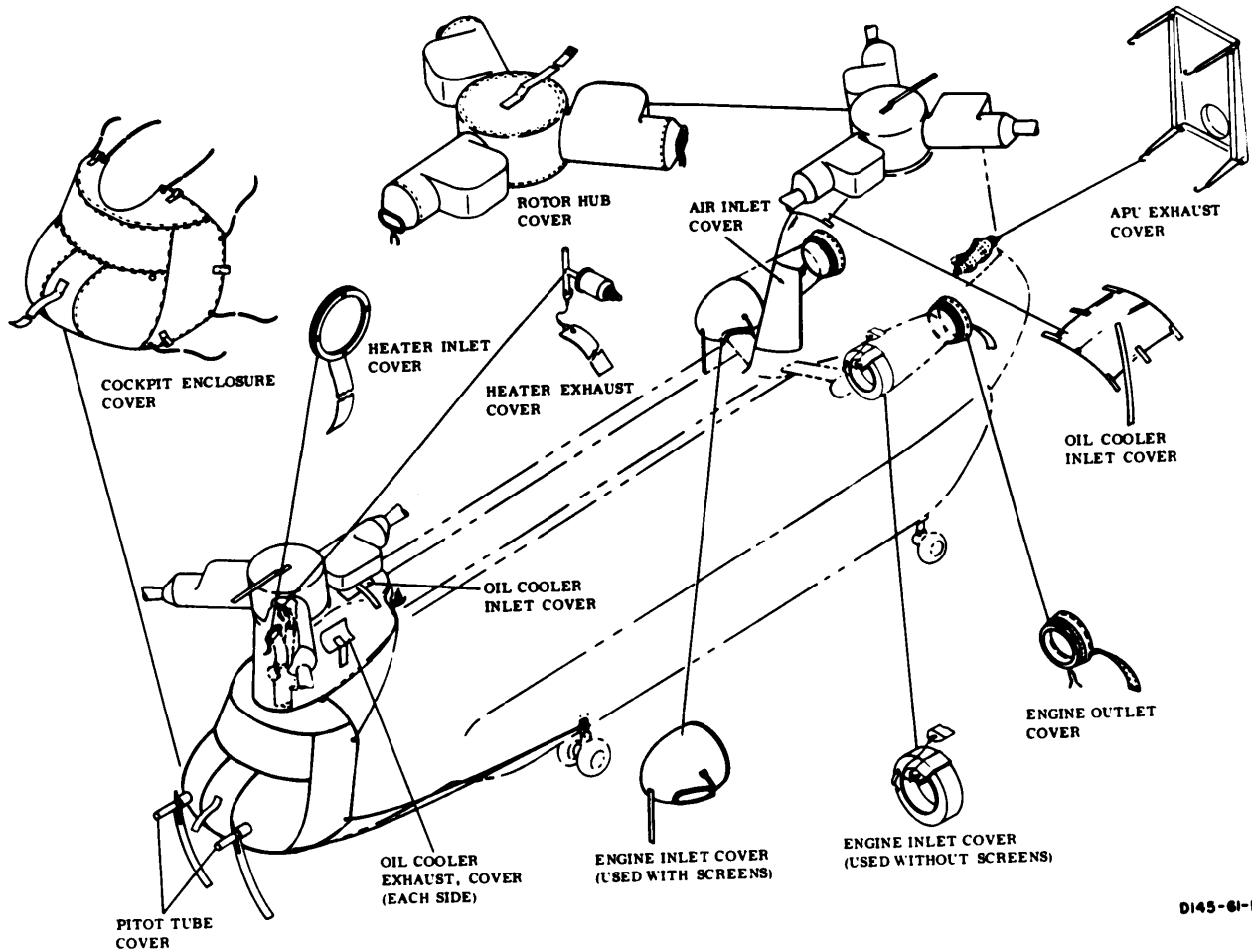
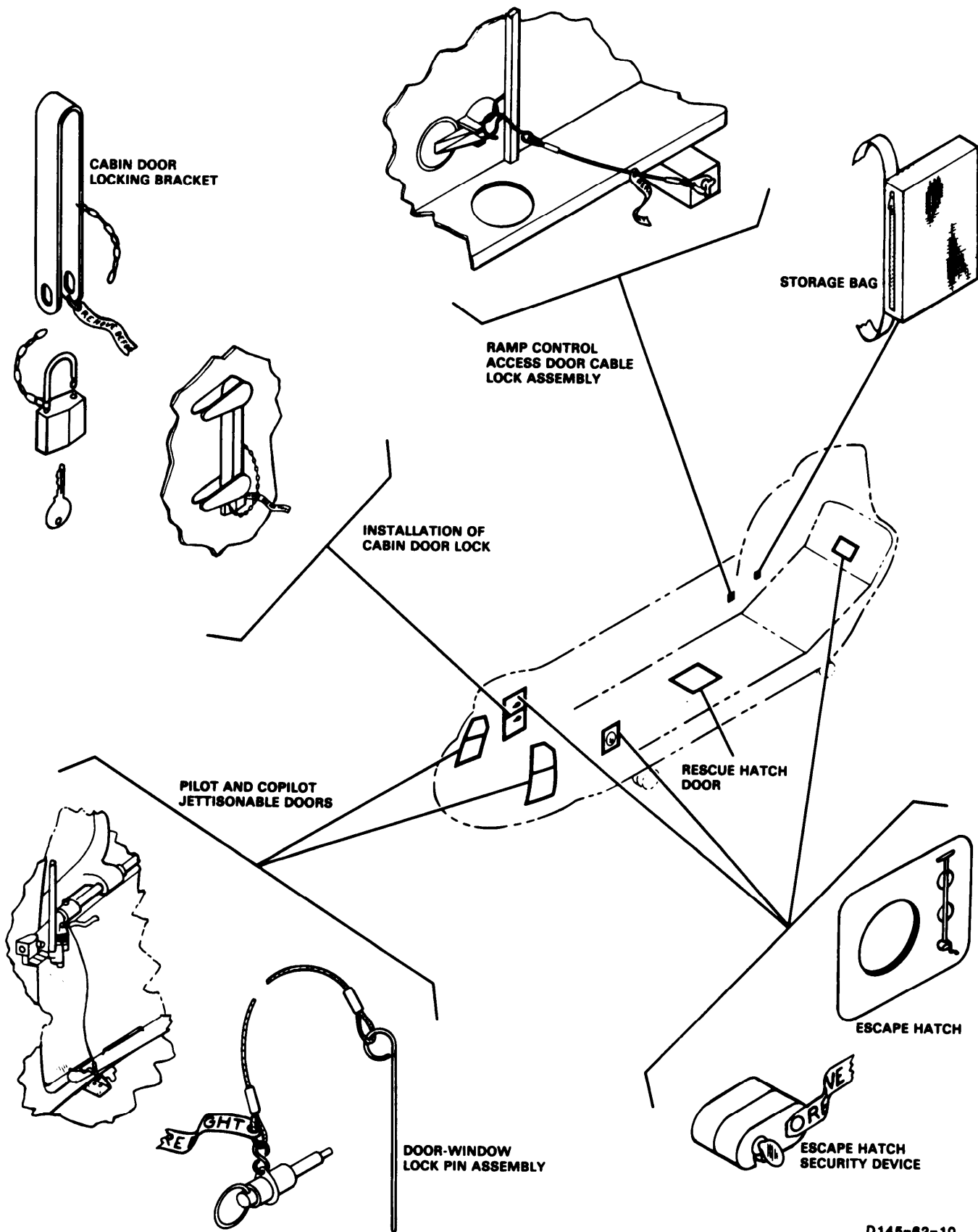


Figure 2-55. Protective Covers



D145-62-10

Figure 2-56. Installation of Helicopter Security Devices (Typical)

## CHAPTER 3 AVIONICS

### SECTION I GENERAL

#### 3-1. Description.

The avionic systems in the CH 47D helicopters consist of the communications equipment providing HF, VHFAM, VHF-FM, and UHF-AM communications. The navigation equipment includes LF-ADF, VOR ILS, Marker Beacon, Doppler/GPS, and Omega. VHF-FM homing is provided through the AN/ARC-201 FM communication radio. Transponder equipment consists of an IFF receiver-transmitter with inputs from the barometric altimeter for altitude encoding. Absolute height is provided by a radar altimeter. For mission avionics equipment, refer to Chapter 4, Mission Equipment.

#### 3-2. Avionics Equipment Configuration.

Equipment configuration in the CH-47D helicopter is listed in table 3-1.

#### 3-3. Avionics Power Supply.

Power to operate the avionic systems is supplied by the No. 1 and No. 2 DC buses, the DC essential bus, and No. 1 and No. 2 115-volt and 26-volt AC buses (Chapter 2).

The No. 1 VHF AM/FM, interphone and UHF sets can be operated by selecting the BATT switch to ON. To operate the remaining avionics equipment, the APU generator or the main helicopter generators must be operating, or AC ground power must be connected. All circuit breakers must be in.

Table 3-1. Communications/Navigation Equipment

FACILITY	DESIGNATION	USE	LOCATION
INTERPHONE	C-6533/ARC	INTERCOMMUNICATIONS BETWEEN CREWMEMBERS AND RADIO CONTROL	THREE INTERPHONE CONTROLS ON CONSOLE, THREE INTERPHONE CONTROLS IN CABIN
UHF RADIO	AN/ARC-164	TWO-WAY UHF-AM COMMUNICATIONS	CONTROL ON CONSOLE (INCLUDES R/T)
VHF AM/FM RADIO	AN/ARC-186	TWO-WAY VHF AM/FM COMMUNICATIONS	CONTROL ON CONSOLE (INCLUDES R/T)
VOICE SECURITY EQUIPMENT	TSEC/KY-58	TWO-WAY CLEAR OR SECURE VOICE COMMUNICATION FOR NO. 1 VHF/FM RADIO	CONTROL ON CONSOLE
	TSEC/KY-75	COMSEC	CONTROL ON CONSOLE (IF INSTALLED)
	TSEC/KY-100	SECURE VOICE AND DATA COMMUNICATION. OPERATIONAL WITH NARROW AND WIDE BAND RADIOS (HF, VHF, UHF, SATCOM)	CONTROL ON CONSOLE (IF INSTALLED)
VHF NAVIGATION AND INSTRUMENT LANDING SYSTEM	AN/ARN-123	PROVIDES VOR BEARING AND COURSE INFORMATION, ILS LOCALIZER, GLIDE SLOPE, AND MARKER BEACON INDICATIONS	CONTROL ON CANTED CONSOLE
DIRECTION FINDER SET	AN/ARN-89	AUTOMATIC OR MANUAL DIRECTION FINDING AND HOMING	CONTROL ON CANTED CONSOLE
GYROMAGNETIC COMPASS SET	AN/ASN-43	PROVIDES HEADING INFORMATION IN FREE GYRO OR MAGNETIC MODES	CONTROL ON OVERHEAD SWITCH PANEL
DOPPLER NAVIGATION SET	AN/ASN-128	PROVIDES WORLDWIDE NAVIGATION CAPABILITY WITHOUT USE OF GROUND FACILITIES	CONTROLS ON CANTED CONSOLE
DOPPLER GPS NAVIGATION SET	AN/ASN-128B	PROVIDES WORLDWIDE NAVIGATION CAPABILITY WITHOUT USE OF GROUND FACILITIES	CONTROL ON CANTED CONSOLE (INCLUDES DISPLAY)
TRANSPONDER SYSTEM	AN/APX-100	RADAR IDENTIFICATION AND TRACKING	CONTROL ON CANTED CONSOLES
OMEGA NAVIGATION SYSTEM	AN/ARN-148	PROVIDES NAVIGATION CAPABILITY USING GROUND FACILITIES	CONTROL ON CONSOLE
HIGH FREQUENCY RADIO SET	AN/ARC-199	LONG RANGE TWO-WAY COMMUNICATIONS	CONTROL ON CONSOLE
HIGH FREQUENCY RADIO SET	AN/ARC-220	LONG RANGE TWO-WAY COMMUNICATIONS WITH ALE AND ECCM	CONTROL ON CONSOLE
VHF-FM RADIO	AN/ARC-201	TWO-WAY VHF-FM COMMUNICATIONS AND HOMING	CONTROL ON CONSOLE



## SECTION II COMMUNICATIONS

### 3-4. Interphone System (C-6533/ARC).

The interphone system is a multi-station intercommunication and radio control system for control of voice radio communication. It also monitors the output of navigation radio receivers and warning tones from IFF and radar warning sets. The basic components of the interphone system are six control panels (fig. 3-1). There is one panel each for the pilot, copilot, troop commander, the two gunners stations, and flight engineer. In addition, there is an interphone station for the hoist operator and two external interphone receptacles. Power for the system is supplied by the DC essential bus through the COMM INTPH LH and COMM INTPH RH circuit breakers on the No. 1 and No. 2 PDP.

### 3-5. Controls and Function, Interphone Control (C-6533/ARC). (fig. 3-2)

CONTROL INDICATOR	FUNCTION
Function Selector Switch Position	Five position rotary switch used to select interphone operating mode.
ICS	Connects headset-microphone to interphone system.
1	Connects headset-microphone to No. 1 VHF FM or No. 1 VHF AM/FM radio set.
2	Connects headset-microphone to UHF radio set.
3	Connects headset-microphone to No. 2 VHF AM/FM radio set.
4	Connects headset-microphone to HF radio set.
5	Not used.

**NOTE**

Pilot/Copilot can transmit on all four transmitters. Troop Commander can transmit on the HF and VHF FM transmitters only. Gunners and Flight Engineer cannot access any transmitters.

Receiver Switches 1-5, AUX, and NAV Position switches used to select headset audio input as follows:  
 1- No. 1 VHF FM or No. 1 VHF AM/FM radio

CONTROL/INDICATOR	FUNCTION
	2- UHF radio 3- No. 2 VHF AM/FM radio 4- HF radio 5- Not used AUX - VOR/Localizer NAV - direction finder OFF disables associated audio input to headset. ON radio enables associated input to headset.
HOT MIKE Switch Position	Two position toggle switch enables hands-free operation (PIT/foot switch operation not required) of headset microphone for interphone only.
OFF	Hands-free operation disabled. PTT/foot switch operation required for operation.
HOT MIKE	Hands-free operation enabled.
<b>NOTE</b>	
	Switch settings are not necessary to receive marker beacon, radar warning, and IFF audio tones.
Press to talk (PTT) Switches Position	Two or three position switches used to enable the microphone side of the interphone system when operator is speaking. These switches are described in detail below.
Pilot/Copilot Trigger PTT Switch (on pilot and copilot cyclic stick) Position	Three position PTT switch. Off disables microphone (not pressed) enables headset.
Interphone (First detent)	Enables microphone transmission to all interphone stations, regardless of function switch settings.
Radio transmit (Second detent)	Enables microphone transmission over radio set selected by control panel function switch.
Pilot's/Copilot's Foot Switches (on cockpit floor next to heel slide) Position	Two position PTT switch.

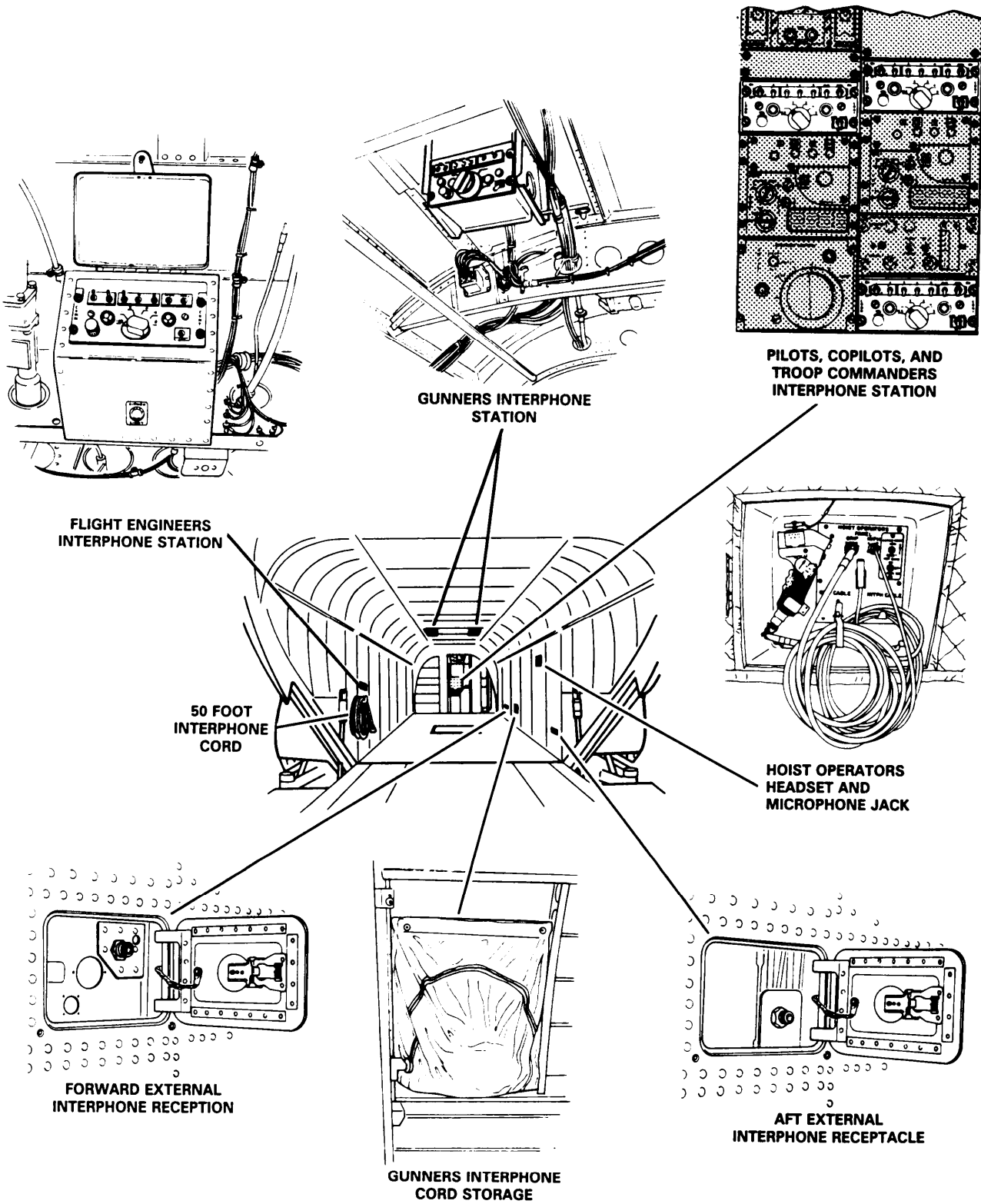


Figure 3-1. Interphone Stations

23576

CONTROL/ INDICATOR	FUNCTION
Off	Released position; disables microphone.
Talk	Depressed position; enables headset microphone.
Hoist Control PTT Switch (on hoist control grip) Position	Two position PTT Switch.
Off	Released position; disables microphone.
Talk	Depressed position; enables headset microphone.
HOT MIKE switch on HOIST OPERATORS PANEL (Chapter 4)	Three position toggle switch selects hoist operator's interphone operating mode.
OFF	Requires operation of PTT switch for interphone communications.
HOT MIKE	Operation of PTT switch not required for interphone communications.
MOM ON	Operation of PTT switch not required for interphone communications. (Spring loaded to OFF position when released.)
Gunner's Foot Switch Position	Two position pressure sensitive switch mounted in moveable floor mat.
Off	Released position; disables microphone.
On	Depressed position; enables microphone.

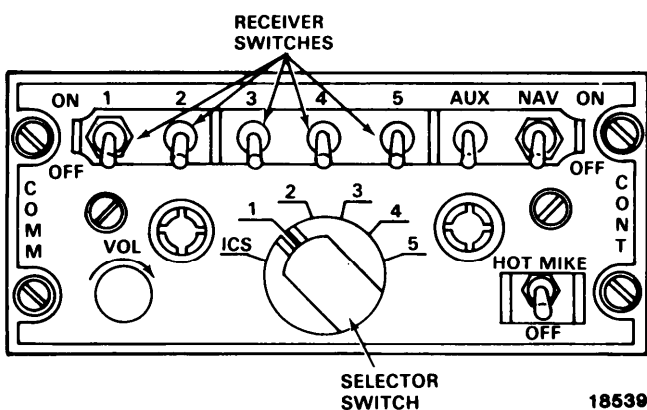


Figure 3-2. Interphone Control (C-6533/ARC)

**3-6. Antenna System.**

Antennas used for avionics communications and electronic systems equipment are shown in figure 3-3. This

figure shows the maximum antenna configuration. All antennas illustrated may not appear on all helicopters.

**3-7. UHF-AM Have Quick II Radio (AN/ARC-164).**

The UHF Have Quick II (HQ II) radio (AN/ARC-164) is located on the center console. It is capable of providing normal and ECCM, anti-jam (AJ) two-way voice communications in the band from 225.000 to 399.975 MHz in 25 kHz increments. The HQ II is capable of operating with the Basic HAVE QUICK radio,. It also provides 20 preset frequencies and will monitor and transmit on a permanent guard channel (243.000 MHz). When in the AJ mode preset 20 is restricted to AJ operations. The usual operating mode for the radio set is the normal mode where the radio uses 1 of 7,000 frequencies. Power for the UHF-AM Have Quick II radio set is supplied by the 28 volt essential bus through the COMM UHF AM circuit breaker on the No. 1 PDP.

There are presently three configurations of the AN/ARC 164 UHF/AM radio. The following paragraphs identify the the visual differences in their configuration.

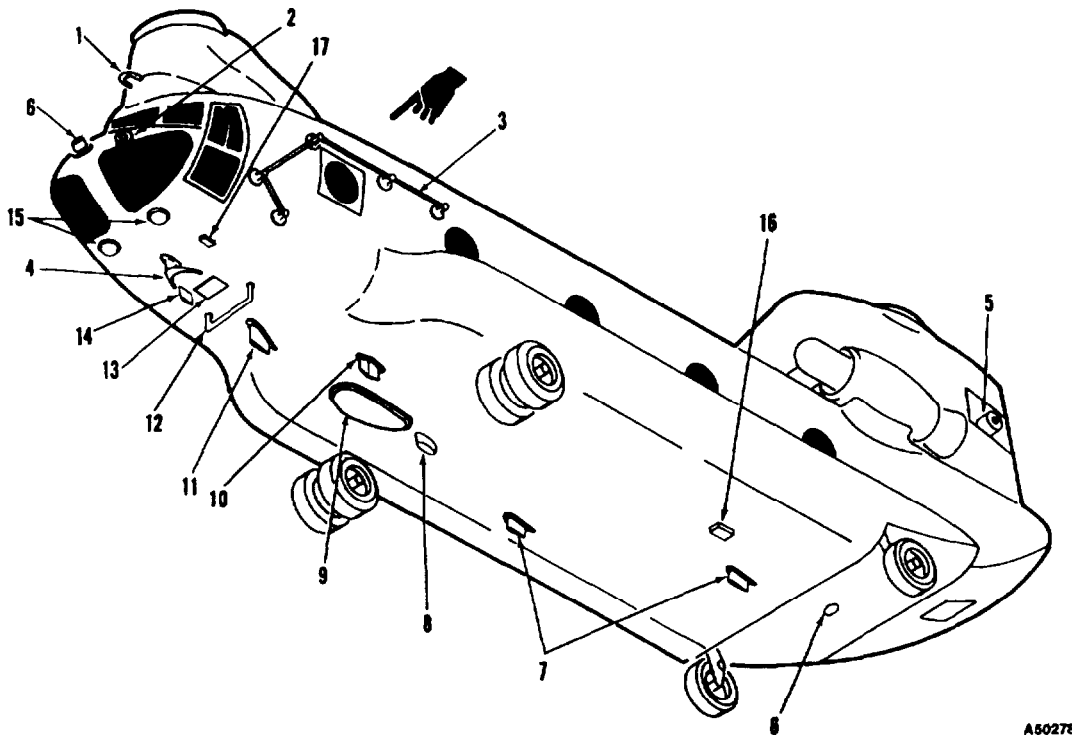
- a. AN/ARC 164, UHF/AM Basic (not modified for Have Quick) 100MHz selector for the hundreds digit only has a 2 and a 3 position.
- b. AN/ARC 164 UHF/AM Have Quick I (capable of single WOD entry only) Has a four position selector for the hundreds digit, A,2,3, and T. Does not have EMB label adjacent to the Pre-set channel selector.
- c. AN/ARC 164 UHF/AM Have Quick II. Same as b. above, but includes EMB label adjacent to the preset channel selector.

Reverse compatible communications between HQ II and HQ I radios in the AJ mode, is accomplished by either, entering a single WOD or selecting the appropriate MWOD and net number with a suffix 00.

**3-7.1. Anti-Jam Mode.**

The AJ mode uses a frequency hopping scheme to change the frequency many times per second. This makes it difficult for the enemy to jam the frequencies since knowledge of the frequencies being used by the pilot are unavailable. Because the particular frequency used at any instant depends on the precise time-of-day (TOD), all participating UHF-AM Have Quick II radios must have clocks which are synchronized. In addition, all participating radios must have the same word-of-day (WOD) and net number data when in the AJ mode.

**3-7.2. Word-of-Day.** The WOD programs the frequency hopping rate and pattern. Without it, the radio cannot function in the AJ mode. A WOD is made up of a maximum of six WOD segments plus a date code. The Have Quick II radios are capable of storing up to six WODs, thus allowing for multi-day use of the radio set. This technique is known as multiple word-of-day



A50278

- |   |   |
|---|---|
| <ul style="list-style-type: none"> <li>1. Glide slope</li> <li>2. Radar warning</li> <li>3. HF ARC-199 antenna</li> <li>4. VHF navigation</li> <li>5. Radar warning</li> <li>6. IFF</li> <li>7. ECM antennas</li> <li>8. Marker beacon</li> </ul> | <ul style="list-style-type: none"> <li>9. ADF loop and sense antennas</li> <li>10. UHF-AM</li> <li>11. VHF AM/FM (typical top and bottom)</li> <li>12. FM homing</li> <li>13. Doppler navigation</li> <li>14. Radar warning blade antenna</li> <li>15. Radar altimeter</li> <li>16. Omega antenna</li> <li>17. Omega temperature probe</li> </ul> |
|---|---|

**Figure 3-3. Antenna Locations**

(MWOD) loading. The basic HAVE QUICK radio allows loading a single WOD, in volatile memory.

Four operating modes are used within the radio set to initiate various Have Quick (HQ) programming functions. They are accessed via preset 20 with the frequencies listed in Table 3-1.1. The functions are Operate/verify, MWOD load, MWOD erase, and frequency managed training (FMT) frequency load.

**Table 3-1.1. Have Quick II Additional Functions Frequency and USE.**

FUNCTION	FREQUENCY	USE
Operate/verify	220,000	Places the radio in the normal operating mode and provides for the verification of an MWOD

FUNCTION	FREQUENCY	USE
MWOD load	220.025	logged for an entered date code. Enables the loading of MWODs.
MWOD Erase	220.050	Enables the pilot to completely erase the non-volatile memory containing the MWODs.
FMT frequency load	220.075	Enables the loading of training frequencies.

MWOD data is stored in nonvolatile memory within the radio set. Seven memory locations are available for each MWOD with the capability of storing a maximum of six MWODs within the radio set. The channel selectors,

the manual frequency selectors, and the tone button are utilized to load the required segments for each MWOD. Channel positions 20-14 are used to facilitate the loading of MWOD segments. A minimum of one WOD must be stored for the unit to be functional in the AJ mode. Channel position 14 is used for day-of-month information (date code). The date code is represented by frequency 3AB.000 MHz in which AB is the day of the month. For example; if today's date is the 15th of the month, the date code entry would be 315.000 MHz. Channel position 1 is used for entering the current operational date when HQ II TOD is not available. The format used to enter the operational date is the same as the date code format.

When the radio is turned off or power is lost after entry of MWOD and date code, the data is not lost; therefore, the information remains intact until manually changed or erased. The six most recently entered MWOD's are retained. If a MWOD with a duplicate date is entered, the new entry takes precedence.

After the MWOD information is entered, the pilot would proceed to obtain the TOD. Operational date information is part of the HQII TOD message. If HQII TOD message is unavailable, the pilot must manually enter the operational date so the radio can select the proper MWOD. If power is lost, operational date is lost and must be reentered.

**3-7.3. Time-of-Day.** The TOD is essential for communicating in the AJ mode which allows frequency-hopping at the same instant in time. Reception and transmission of the TOD is possible in normal and AJ modes. The first TOD reception must occur in the normal mode.

The radio automatically accepts the first TOD message once the predesignated frequency for TOD transmission has been entered and the T position of the hundredth megahertz selector has been momentarily selected and released. Subsequent messages are ignored unless the pilot enables the radio to receive a new/updated TOD. The TOD contained in a radio may also be sent to other radios similarly equipped.

**3-7.4. Net Number.** The net number enables multiple station nets to operate simultaneously on a non-interfering basis in AJ mode, while sharing a common WOD and TOD. The net number begins with the letter A and is followed by three digits from 000 to 999. The last two digits of the display designate how the radio is to function and/ or the frequency hopping table being used (Table 3-1.2). Net number availability is dependent on the operational mode of AJ and is depicted in Table 3-1.3.

Table 3-1.2 Net selection

TACTICAL

- 00 - Basic HAVE QUICK
- 25 - HAVE QUICK II NATO Hopset
- 50 - HAVE QUICK II non-NATO Hopset
- 75 - Not Used-Interrupted fault Tone

Table 3-1.2 Net selection (Continued)  
TRAINING

- 00 - Basic HAVE QUICK Training
- 25 - HAVE QUICK II Training
- 50/75 Not Used- Interrupted Fault Tone

Table 3-1.3 Net Type, Quantity, and Frequency Range

Types of Nets	Quantity	Range of Nets
Basic HQ Training	5	A00.000 – A000.400
Basic HQ Tactical	1000	A00.000 – A01.500
HQ H Training	16	A00.025 – A01.525
HQ II Tactical	1000	A00.0XX–A99.9XX

**NOTE**

Any selection of a net number outside the range indicated, for each type of net, will result in the invalid net number warning tone.

**3-7.5. Conferencing.** In the AJ mode, the radio has the capability to receive and process two simultaneous transmissions on the same net. This conferencing capability is selected by the hundredth and thousandth digits of WOD segment 2, loaded using channel position 19 and is disabled when operating in the secure speech mode.

In a conference net, the second transmitting radio will automatically shift its transmission frequency by 25 kHz when it monitors a transmission on the primary net frequency. The wide band receiver will monitor both transmissions without the interference normally associated with two radios transmitting on the same frequency simultaneously. Three simultaneous transmissions will create garbled reception.

**3-8. Controls and Function, UHF-AM Have Quick II Radio (AN/ARC-184).** (fig. 3-4)

CONTROLS/ INDICATOR	FUNCTION
Function Select Switch	Four position rotary switch used to select radio operating mode.
OFF	Power to set is disabled; radio set inoperative.
MAIN	Radio set can be used to transmit and receive; guard receiver inoperative.
BOTH	Radio set can be used to transmit and receive; guard receiver operates.
ADF	Not used.

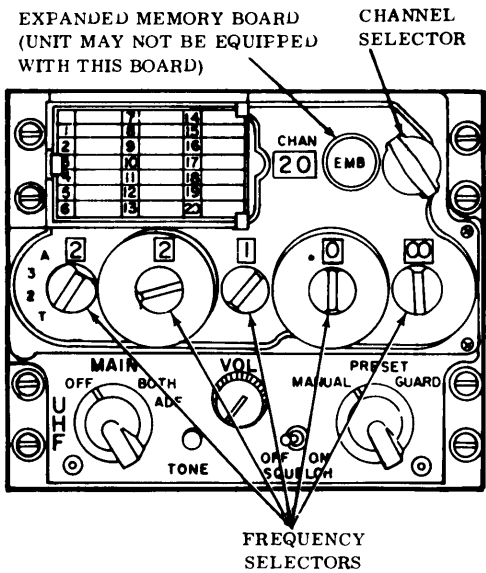


Figure 3-4. UHF-AM Have Quick II Radio (AN/ARC-764)

CONTROLS/ INDICATOR	FUNCTION
VOL	Rotary control used to adjust radio output volume.
SQUELCH Switch	Two position toggle switch to select radio squelch mode.
OFF	Squelch is disabled.
ON	Squelch is enabled.
Frequency Mode Selector	Three position rotary control used to select frequency tuning mode.
MANUAL	Permits manual frequency selection using frequency controls.
PRESET	Permits selection of preset channel frequencies in radio set (maximum of 20 channels).
GUARD	Automatically disables the anti-jam mode and tunes radio set to guard channel frequency (243.000 MHz).
Frequency Selectors	Five rotary controls used to select radio operating frequency or state.
100 MHz Control (A-3-2-T)	Four position rotary control switch.
A	Selects anti-jam mode.
3	Hundreds digit of desired frequency while in the normal mode.
2	Hundreds digit of desired frequency while in the normal mode.
T	Momentary spring-return position which enables the radio to accept a new TOD for up to one minute after selection. Also used in conjunction with the tone button in the emergency startup of the TOD clock when TOD is not available from external sources.
10 MHz Control	Ten position (0 through 9) rotary control used to select second digit of operating frequency. When in AJ mode, it selects the first digit of net number.

CONTROLS/ INDICATOR	FUNCTION
TONE	Momentary contact switch. Pressing the TONE switch when in the normal mode enables a 1020 Hz tone on the selected frequency, unless TOD has been accepted in which case a 1667 Hz tone is heard prior to the 1020 Hz tone. When A-3-2-T switch is in A, it enables TOD transmission followed by a 1020 Hz tone on the selected frequency. When A-3-2-T switch is in T, it initiates the emergency startup of the TOD clock. When in the load mode, Pressing the TONE switch with channels 1, 14, or 15 through 20 selected in the manual mode enters the MWOD data into non-volatile memory. Pressing the TONE switch when in the erase mode, erases all MWOD data from non-volatile memory.

CONTROLS/ INDICATOR	FUNCTION
1 MHz Control	Ten position (0 through 9) rotary control used to select third digit of operating frequency. When in AJ mode, it selects the second digit of net number.
0.1 MHz Control	Ten position (0 through 9) rotary control used to select fourth digit of operating frequency. When in AJ mode, it selects the third digit of net number.
0.025 MHz Control	Four position rotary control used to select fifth and sixth digits of operating frequency. Operates in 0.025 MHz increments. When in the AJ mode, it selects the appropriate frequency table within the radio net.
Frequency Display	Six digit display (200.00 through 399.975) displays selected radio operating frequency.
Channel Selector	Used to select and display any of the 20 preset radio frequency channels. Displays selected preset channel.
PRESET Switch (Under channel/frequency card)	Momentary contact switch, when depressed causes selected radio frequency entered on frequency display to be stored in channel indicated on channel display, in normal operation.

**3-9. Normal Operation - UHF-AM Have Quick II Radio.** The following steps provide operating procedures.

- a. Starting.
  - (1) Interphone control panel – Set switches as follows:
    - (a) Receiver 2 switch – ON.
    - (b) Function select switch – 2.
  - (2) Function switch – MAIN or BOTH.
  - (3) Mode selector – As required.
  - (4) SQUELCH switch – As required.
  - (5) VOL control – As required.

- b. Presetting Channels. Perform the following steps to preset a channel to a desired frequency.
  - (1) Set the Frequency Mode Selector to PRESET.
  - (2) Use the manual frequency selector switches to select the frequency to be placed in memory.
  - (3) Turn the preset channel control switch to the desired channel number.
  - (4) Raise the cover under the channel card. Press and release the PRESET switch. Close the cover.
  - (5) Using a soft lead pencil, record the frequency selected for the channel number on the card provided.
- c. Stopping. Function switch – OFF.

**3-9.1. Anti-Jam Operation - UHF-AM Have Quick II Radio.** The following steps provide AJ operating procedures.

- a. MWOD Loading.
  - (1) Perform paragraph 3-9 Starting steps a(1) and a(2).
  - (2) Channel selector switch – Set to 20.
  - (3) Frequency mode selector switch – PRESET.
  - (4) Frequency selector switches – Set 220.025 MHz.
  - (5) PRESET switch – Press. Radio is now programmed to accept MWOD.
  - (6) Frequency mode selector switch – MANUAL.
  - (7) Frequency selector switches – Enter first WOD segment.
  - (8) TONE switch – Press. First WOD segment is now loaded to the nonvolatile memory of the radio – Listen for BEEP.
  - (9) Channel selector switch – Set to 19.
  - (10) Frequency selector switches – Enter second WOD segment.
  - (11) TONE switch – Press.
  - (12) The remaining four WODs can be loaded in a similar fashion by dialing the next lower preset channel, selecting the next WOD segment. After entering last segment, listen for a double (3125 Hz) beep.
  - (13) Channel selector switch – Set to 14.
  - (14) Frequency selector switches – Enter date code.
  - (15) TONE switch – Press. At this time, one complete WOD with its corresponding date code has been entered to the nonvolatile memory.

- (16) Additional WODs can be loaded by repeating steps (5) through (15). Once WODs have been entered, today's operational date must then be entered.
- (17) Channel selector switch – Set to 1.
- (18) Frequency selector switches – Enter operational date.
- (19) TONE switch – Press.

b. Operate/Verify Modes.

- (1) Operate Mode.
  - (a) Frequency mode selector switch – PRESET.
  - (b) Channel selector switch – Set to 20.
  - (c) Frequency selector switches – Enter 220.000 MHz.
  - (d) PRESET switch – Press. Radio set is now programmed to operate in either normal mode or anti-jam mode.
- (2) Verify Mode.

**NOTE**

This verification test only checks for presence of a WOD with the corresponding date code. It does not check for the authenticity of the WOD segments entered.

- (a) Channel selector switch – Set to 20.
- (b) Frequency mode selector switch – MANUAL.
- (c) Frequency selector switches – Enter date code to be verified.

**NOTE**

If a single beep is not present for a particular date code and the anti-jam mode is entered using that date, a constant warning tone will be heard signifying that the anti-jam mode initialization cannot be properly completed.

- (d) Channel selector switch – Set to 19, then back to 20. A single beep will be heard if a WOD with the date code in step (c) is present.

c. Erase Mode.

- (1) Channel selector switch – Set to 20.
- (2) Frequency mode selector switch – PRESET.
- (3) Frequency selector switches – Enter 220.050 MHz.
- (4) PRESET switch – Press.
- (5) Frequency mode selector switch – MANUAL.

- (6) TONE switch – Press. All MWODs are now erased.

d. Training Frequency Load.

- (1) Channel selector switch – Set to 20.
- (2) Frequency mode selector switch – PRESET.
- (3) Frequency selector switches – Enter 220.075 MHz.
- (4) PRESET switch – Press.
- (5) Frequency mode selector switch – MANUAL.
- (6) Frequency selector switches – Enter desired training frequency.
- (7) TONE switch – Press. A single beep will be heard.
- (8) The next frequency is loaded by entering the next lower preset channel, selecting the next training frequency, and pressing the TONE switch. Up to 16 training frequencies may be entered. Following this procedure.

e. TOD.

- (1) TOD Receive/Update.

**NOTE**

The first TOD message received within one minute of selecting T on the hundreds frequency selector switch will be accepted. When communications are slightly garbled but otherwise acceptable during AJ operations, this is an indication of drift in TOD synchronization. A TOD update should be performed.

- (a) Frequency selector switches or channel selector switch - Set to predetermined TOD frequency.
- (b) Hundreds frequency selector switch – Momentarily select T, then release. A momentary 1667 Hz tone will be heard while receiving the TOD message.

**NOTE**

The following step is not necessary if TOD message is being transmitted continuously on the predetermined TOD frequency; for example, continuous TOD message is being transmitted from a satellite.

- (c) Request TOD from another station within the net.
- (2) TOD Send.
  - (a) Frequency selector switches or channel selector switch – Set to predetermined TOD frequency.
  - (b) TONE switch – Press. A momentary 1667 Hz tone will be heard, when the



TOD message is transmitted, followed by a 1020 Hz tone until switch is released.

(3) Emergency TOD Start-up.

**NOTE**

The emergency TOD start-up provides an arbitrary TOD which is not synchronized to coordinated time. The radio set will not communicate with any other Have Quick II radio set in AJ mode unless this new TOD is transmitted to other radio sets.

- (a) Perform step a MWOD Loading
- (b) Perform step b (1) Operate Mode
- (c) Hundreds frequency selector switch – Select T and hold while simultaneously pressing TONE switch. A 1667 Hz tone will be heard when the TOD is programmed.
- (d) TONE switch – Release.
- (e) Hundreds frequency selector switch – Release.

f. Anti-Jam Mode.

- (1) Perform paragraph 3-9 step a Starting.
- (2) Load MWOD – Refer to paragraph 3-9.1 step a MWOD Loading.
- (3) Receive TOD – Refer to paragraph 3-9.1 step e(1) TOD Receive/ Update.
- (4) Perform paragraph 3-9.1 step b(1) Operate Mode.

**NOTE**

A steady 3125 Hz warning tone will be heard when the anti-jam (A) mode is selected and either the WOD is not in the nonvolatile memory or the TOD has not been programmed.

- (5) Hundreds frequency selector switch – A.
- (6) Other frequency selector switches – Enter net number.

**3-10. VHF AM/FM Radio Sets (AN/ARC-186).**

a. One or two VHF AM/FM radio sets (AN/ARC-186) are installed: No. 1 set on the pilot side of the console, No. 2 on the copilot side. Each set provides communications in the VHF AM and FM bands. The set operates in the following modes and frequency ranges: AM reception between 108.00 and 151.975 MHz, AM receive and transmit between 116.000 and 151.975 MHz, and FM transmit, receive, and homing from 30.000 to 87.975 MHz. Channel spacing is 25 kHz in all bands. Up to 20 channels plus two guard channels can be prestored in the set (removing power from the set does not affect stored channels). When the set is used for FM homing and selected for display on the HSI

by the HSI MODE SELECT panel, steering information will be shown by the course deviation indicator; homing signal strength will be shown by the glideslope deviation pointer; and homing signal adequacy warning will be shown by the glideslope failure and navigation failure warning flags. The set operates on 28-volt DC power: No. 1 set receives power from the DC essential bus through the COMM VHF NO. 1 AM/FM circuit breaker in the No. 2 PDP; No. 2 set receives power from the No. 1 DC bus through the COMM VI-IF NO. 2 AM/FM circuit breaker on the No. 1 PDP.

b. *Antenna Select System* Three antennas are installed as part of the AM/FM radio installation: a top and bottom communications antenna and a FM homing antenna. Both AM and FM can be transmitted and received over the same antenna but not at the same time. Antenna selection is controlled by the two position VHF ANT SEL switch on the center instrument panel. The normal switch position is down at the SYS 2 - SYS 1 position. The No. 1 AM/FM set is connected to the bottom antenna and the No. 2 AM/FM set is connected to the top antenna. If a water landing is to be made or the bottom antenna is damaged, setting the switch up to SYS 1- SYS 2 reverses the normal antenna connections and connects the No. 1 AM/FM set to the top antenna and the No. 2 AM/FM set to the bottom antenna. This ensures that secure voice is available through the top antenna. Power to operate the system is supplied by the DC essential bus through the VHF ANT SEL circuit breaker on the No. 2 PDP.

**NOTE**

The antenna select system has no effect on the FM homing antenna. The homing antenna (towel bar) is on the bottom of the fuselage aft of the cockpit (fig. 3-3) and is connected to the FM set only.

**3-11. Controls and Function, VHF AM/FM Radio Set. (fig. 3-5)**

CONTROLS/ INDICATOR	FUNCTION
Mode Select Switch	Three position rotary switch used to select radio operating mode. Power is applied to radio in all positions except OFF.
OFF	Power to set is disabled, radio is inoperative.
TR	Radio operates in the transmit-receive mode.
DF	Radio operates in the direction finder mode.
Frequency Control/ Emergency Select Switch	Four position rotary used to select radio frequency tuning mode.

CONTROLS/ INDICATOR	FUNCTION
EMER AM	Radio is tuned to AM Guard channel frequency.
EMER FM	Radio is tuned to FM Guard channel frequency.
N A B	Allows manual tuning of radio operating frequency.
PRE	Allows selection of any of 20 preset operating frequencies.
VOL	Rotary control adjusts radio output volume.
SQ DIS/TONE Switch	Three position toggle switch used to select radio squelch operation.
Normal (center position)	Preset squelch level is selected.
SO DIS	Squelch operation is disabled.
TONE	Not used - maintenance operation only.
Preset Channel Selector	Twenty position rotary control used to select any of 20 preset channel frequencies.
Frequency Controls	Display selected radio operating preset channel.
10 MHz Control	Four rotary controls used to manually select radio operating frequency.
1 MHz Control	Thirteen position (03 through 17) rotary control used to select first and second digits of operating frequency.
1 MHz Control	Ten position (0 through 9) rotary control used to select third digit of operating frequency.
0.1 MHz Control	Ten position (0 through 9) rotart control used to select fourth digit of operating frequency.
0.025 MHz Control	Four position rotary control used to select fifth and sixth digits (00 through 75) of operating frequency in 0.025 MHz increments.

CONTROLS/ INDICATOR	FUNCTION
Frequency Display	Display selected radio operating frequency.
WB/NB/MEM LOAD Switch (under channel card)	Three position toggle switch used to select radio operating band, and during preset channel frequency loading.
NB	Places radio in NB (narrow band) operation.
WB	Places radio in WB (wide band) operation.

**NOTE**

Switch will remain in WB position unless otherwise instructed by radio set controller.

MEM LOAD	Momentary contact position used with frequency controls and channel selector to load preset channels.
----------	---

**3-12. Normal Operation - AM/FM Radio Set.** The following steps provide operating procedures.

- a. Starting.
  - (1) Interphone control panel – Set switches as follows:
    - (a) Receiver 3 switch – ON.
    - (b) Selector switch – 3.
  - (2) VHF ANT SEL switch – SYS 2- SYS 1.
- b. Transmit-receive mode.
  - (1) Mode select switch – TR.
  - (2) Frequency Control/Emergency Select Switch - As required. If greater receiver sensitivity is required, set the SQ DIS/TONE switch to SQ DIS.
  - (3) VOL control – As required.

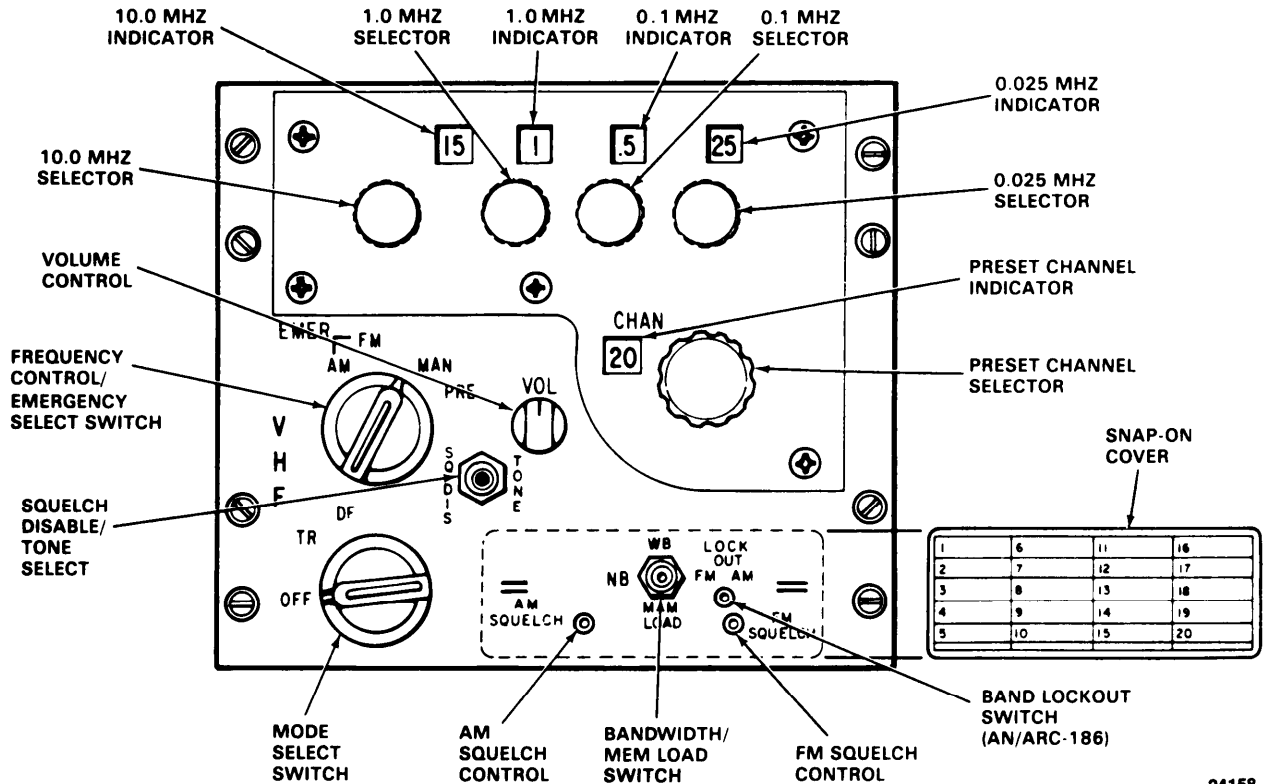


Figure 3-5. VHF AM/FM Radio Set (AN/ARC- 786)

- c. Stopping. Mode select switch – OFF.
- d. Presetting channels. Perform the following steps to preset a channel to a desired frequency.
  - (1) Mode select switch – TR.
  - (2) Frequency select switch – MAN.
  - (3) Rotate the four frequency select switches until the desired frequency is displayed.
  - (4) Rotate the preset channel selector until the desired channel appears in the preset CHAN indicator.
  - (5) Remove the snap-on cover.
  - (6) Momentarily set the bandwidth WB, NB, MEM LOAD switch to MEM LOAD. The preset frequency is now in memory.
  - (7) Using a soft lead pencil, record the loaded frequency opposite the channel number on the snap-on cover.
  - (8) Using the above procedure, preset any other channels and install the snap-on cover.

**3-13. VHF/FM Radio Set (AN/ARC-201).**

The AN/ARC-201 is located on the pilot instrument panel and provides two-way frequency modulated (FM) narrow band voice communications.

- a. The following items form the airborne radio system.

ITEM	DESCRIPTION
1.	Receiver-Transmitter Radio Panel Mounted (RT-1476)
2.	Amplifier (AM 7189)

b. Essential Operational Technical Characteristics. Except where specifically indicated otherwise, the following operational/ technical parameters are the minimum essential characteristics. Unless otherwise specified, they apply to each radio configuration.

c. Frequency Range. The frequency range is 30 to channelized in tuning increments of 25 kHz. In addition a frequency offset tuning capability of

-10 kHz, -5kHz, + 1kHz is provided in both receive and transmit mode; this frequency is not used in the ECCM mode.

d. Homing.

- (1) Mode select switch – HOM.
- (2) Operating frequency – Set.

**NOTE**

Any strong single channel signal within the frequency range of the radio set can be used for homing.

(3) FM button on HSI MODE SELECT PANEL – press. Check that SEL lamp is lit.

(4) Homing procedures. The course deviation bar on the HSI provides the primary navigation indication when the set is in homing mode. The bar only provides information on whether the helicopter is left, right, on a heading to the signal source, or over the signal source. The TO-FROM ambiguity arrows will not function and the selective course feature is not available. Ambiguity is solved using either of the following methods:

(a) Directional method. When the helicopter is heading inbound to the signal source with the bar centered, the indications are directional in that a change in heading to the right will cause the bar to drift to the left. Conversely, a change in heading to the left will cause the bar to drift to the right. When the helicopter is heading outbound from the signal source with the vertical pointer centered, the indications are nondirectional in terms of steering. A change in heading to the right will cause the bar to drift to the right. A change in heading to the left will cause the bar to drift left.

(b) Build and fade method. If the signal source is transmitting a 150-Hz tone-modulated signal and the helicopter is inbound to the signal source, the tone will increase in intensity. The tone will decrease in intensity on an outbound heading.

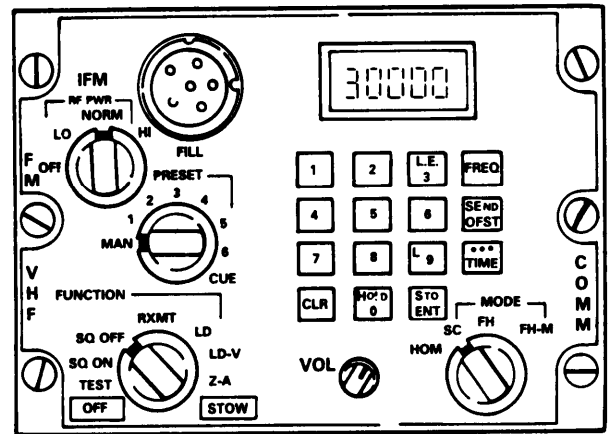
(5) Additional homing characteristics. The following additional characteristics may be observed when homing. The glideslope deviation pointer will rise from the horizontal mark when the aircraft is inbound (increasing signal strength) to a transmitter. The pointer will fall to the horizontal mark when outbound. The glideslope failure and navigation failure warning flags will be in view if there is inadequate homing signal strength. A dip in the horizontal pointer may or may not occur when passing over the station, depending on the signal source, helicopter speed, and altitude.

**3-14. Controls and Functions VHF/FM Radio Set.**  
(fig. 3-6)

CONTROLS/ INDICATOR	FUNCTION
<u>Function Selector</u>	
OFF	Primary power OFF. Memory battery power ON.
TEST	RT and ECCM modules are tested. Results; GOOD or FAIL.
SQ ON	RT on with squelch.
SQ OFF	RT with no squelch.,
RXMT	RT in RECEIVE mode. Used as a radio relay link.
LD	Keyboard loading of pre-set frequencies.
LD-V	TRANSEC variable loading is enabled.
Z-A	Not an operational position. Used to clear the TRANSEC variable.
STOW	All power removed. Used during extended storage.
<u>Mode Selector</u>	
HOM	Homing antennas are active; communication antenna is disconnected. Provides pilot with steering, station approach, and signal strength indicators.
SC	Single channel mode of operation. Operating frequency selected by PRESET selector or keyboard entry.
FH	Frequency hopping mode selected. PRESET selector positions 1-6 select frequency hopping net parameters.
FM-M	Frequency hopping-master position selects control station as the time standard for communicating equipment.
<u>Preset Selector</u>	
MAN	Used in single mode to select any operating frequency in 25 kHz increments.

CONTROLS/ INDICATOR	FUNCTION
POS. 1-6	In single channel mode, preset frequencies are selected or loaded. In FH or FM-M mode, frequency hopping nets are selected.
CUE	Used by a non-ECCM radio to signal to CUE or ECCM radio.
<u>IFM RF Selector</u>	
OFF	(Bypass) - 10 watts.
LO	(Low power) - 2.5 watts,
NORM	(Normal) - 10 watts.
HI	(High power) - 40 watts.
<u>Display</u>	The display generally operates in conjunction with the keyboard. Other displays may be selected by the FUNCTION and MODE selectors.
<u>Keyboard</u>	A 15-button array of switches in a 4 x 4 matrix, used to insert data or select data for display. The keyboard is comprised of 10 numerical buttons, three special functions, and two command buttons.
Switches 1-9	Used to key in frequencies, load time information, or offsets.
CLR	Used to zeroize the display or to clear erroneous entries.
0 (H-LD)	Used to enter zeroes. Second function (hold) initiates transfer of ECCM parameters.
STO/ENT	Initiate entry of all data by keyboard entry. Its second function is to store a received Hopset or Lockout Set held in holding
FREQ	Display the current operating frequency during single channel (manual or preset) operation.

CONTROLS/ INDICATOR	FUNCTION
SEND/OFST	Modify a single channel operating frequency, manually select or preset, to include offsets of $\pm 5$ or $\pm 10$ kHz. It has a second function on initiating an ERF Transmission if a Hopset or Lockout Set is in the holding memory and the Mode Switch is in the FH-M position.
TIME	Used to display or change the time setting maintained within each RT.
FILL	Used to fill ECCM parameters from an external fill device. Entry of ECCM parameters is initiated by the H-LD button on the keyboard with the FUNCTION switch in LD or LD-V.



23326

Figure 3-6. VHF/FM Radio Set (AN/ARC-201)

**3-15. HF Radio Set (AN/ARC-HF-SSB 199).**

The HF radio set (AN/ARC-199) provides communication in a 28 MHz high frequency band between 2.0 to 29.999 MHz. Transmit and receive frequencies are programmable in 100 Hz steps on 20 preselectable channels, for a total of 280,000 possible frequencies. The operating modes of the HF radio set are Upper and lower sideband (USB, LSB), amplitude modulation equivalent (AME), and modulated carrier wave (MCW). The data may be transmitted or received in LSB, USB, or AME modes. DC power to operate the HF radio set is supplied by the No. 2 DC bus through the COMM ARC-199 HF and PWR circuit breakers on the No. 2 PDP.

**3-16. Display Fields, Controls and Function, HF Radio Set (AN/ARC-199).** (fig. 3-7)

CONTROLS/ INDICATOR	FUNCTION
<u>Display Field</u>	
Field 1	Channel - This field appears in inverse video to indicate that current channel information has not been stored.
Field 2	Active channel number: 0 through 20
Field 3	Modulation on Mode: USB, LSB, AM, CW. CW represents MCW and may be used in conjunction with the mic key to transmit code.
Field 4	Receive frequency in kilohertz
Field 5	Transmit frequency in kilohertz,
Field 6	Squelch Level - Display MIN, 1, 2, 3, through 14, MAX in conjunction with squelch knob in control panel.
Field 7	Receive Selective Address.
Field 8	Transmit Selective Address. In the sample display shown above, ON indicates that SELADR mode is operational for RX. If SELADR is operational for TX, ON is announced on the line with TX.
Field 9	Transmitter Output Power - LOW, MED, or HI.
Field 10	Modulation Source. The field displays are:
DATA	Indicates 600 ohm data input.
CIPHER	Indicates input from KY-75 input. (If installed).
CLR-VC	Indicates non-encrypted KY-75 input. (If installed).
Field 11	Fault Field. Displayed fault messages are: NOT TUNED, DATA NOT SAVED, and AUDIO VOLUME LEVEL:

CONTROLS/ INDICATOR	FUNCTION
	VOL MIN 1, 2, 3, through 14, MAX.

**NOTE**

AUDIO VOLUME LEVEL should normally be set at 14. Adjust HF volume using external volume control on console.

Field 12 S (SCAN) - Indicates that the currently displayed channel is on the scan list.

Field 13 Indications are: XMIT, TEST, SCAN, or TUNE.

XMIT Transmitter is keyed and channel is tuned.

TEST Built-in-test (BIT) mode is active.

SCAN Scan mode is active.

TUNE Tuning for one or all channel - blank if not one of the above keys are active.

Field 14 K (Key) - Indicates KEY has been pressed, and the functions above the keys are active.

M (MODE) - Indicates MODE has been pressed, and USB, LSB, AM, or CW should be selected next. Indicates slewing may be used, or scan flag may be set or cleared.

Controls

Function Select Power ON/OFF, CRT brightness, audio volume and channel number selection.

Function Control Single-step, detent-type switch, with continuous rotation in either direction. Clockwise rotation increases and counter-clockwise rotation decreases the CRT brightness, audio volume, or channel number. In cases of CRT brightness and audio volume, knob has no effect once limit of that particular function has been reached. In

CONTROLS/ INDICATOR	FUNCTION
	channel select mode, function control knob is continuously active. That is, channel 20 is always one position counterclockwise from channel 0.
Squelch Control	Continuous rotation in either direction; squelch level is annunciated in field #6. Once upper or lower limit of squelch has been reached, further operation of knob in same direction has no effect.

**3-17. Operating Modes/Functions, HF Radio Set (AN/ARC-199).** (fig. 3-7)

CONTROLS/ INDICATOR	FUNCTION
Power ON/OFF	On Function Select Knob.
Ready Indication	When the radio is initially powered on, a system ready message will be displayed for a few seconds. The channel 0 information will then be displayed.
CRT Brightness	Set Function Select Knob to BRT. Rotate the Function Control Knob in the desired direction to increase or decrease brightness.
Audio Volume	Set Function Knob to VOL, rotate the Function Control Knob in the desired direction to increase or decrease audio volume. Audio volume is not a stored parameter. Audio volume level is annunciated briefly in the fault area of the display when the level is being changed. The display levels are: MIN, 1, 2, 3 through 14, MAX. A secondary HF audio volume control is located in the console. This is provided for audio level compatibility with the KY-75 (if installed). Preset the CDU VOL level to the max. position and adjust the secondary

CONTROLS/ INDICATOR	FUNCTION
Channel Number	volume control for the desired level. Channel number may be changed using the Function Select and Function Control Knob or by using a combination of key-strokes.
Modulation Mode	Four modes are available: USB, LSB, AM (AME), and CW (MCW). To change from one mode to another, press MODE + desired mode key + ENT.
Receive Frequency	2.0-29.9999 MHz, programmable in 100 Hz steps. To change frequencies press KEY + FRQ RX + desired frequency + ENT.
Transmit Frequency	2.0-29.9999 MHz programmable in 100 Hz steps. To change frequencies press KEY +FRQ TX + desired frequency + ENT.
Squelch Level	Single step, detent-type control; squelch level is annunciated on the display and varies from MIN, 1, 2, 3 through 14, MAX. The squelch level is not a stored parameter.
Transmit Selective Address	A 4-letter code programmed by pressing HE KEY+ SELTX + a 4-letter code + ENT, or by activating SELADR RX and keying the mic.
Receiver Selective Address	A 4-letter code programmed by pressing KEY + SEL RX + a 4-letter code + ENT. Receive selective address mode is activated by using key sequence: KEY + SEL RX + ON + ENT.
Output Power Level	Three output power levels are selectable from the keyboard; LO, MED, or HI. The key sequence used is KEY + LO, MED, or HI + ENT.

CONTROLS/ INDICATOR	FUNCTION
------------------------	----------

**Modulation Source**  
Audio sources available are CLR-VC (clear voice), DATA, or encrypted audio when used with voice security equipment. CIPHER is displayed when the KY-75 is in the secure voice mode. DATA and CLR-VC modes are selectable from control panel, when KY-75 is in non-secure mode, using key sequence: KEY + (SV-DATA or CLR-VC) + ENT. The modulation source is not a stored parameter.

**Tune**  
By using appropriate key sequence, either currently displayed channel or all 20 channels may be tuned to the antenna. The tuning information is stored for future use with no tuning necessary. Current channel may be tuned by pressing KEY + TUNE + ENT. All 20 channels may be tuned by pressing KEY + TUNE + SCAN + ENT.

**TEST**  
Built-in-Test (BIT) feature allows operator to test both receiving and transmitting capabilities at several frequencies. Any failure to meet predetermined performance levels results in a failure message being

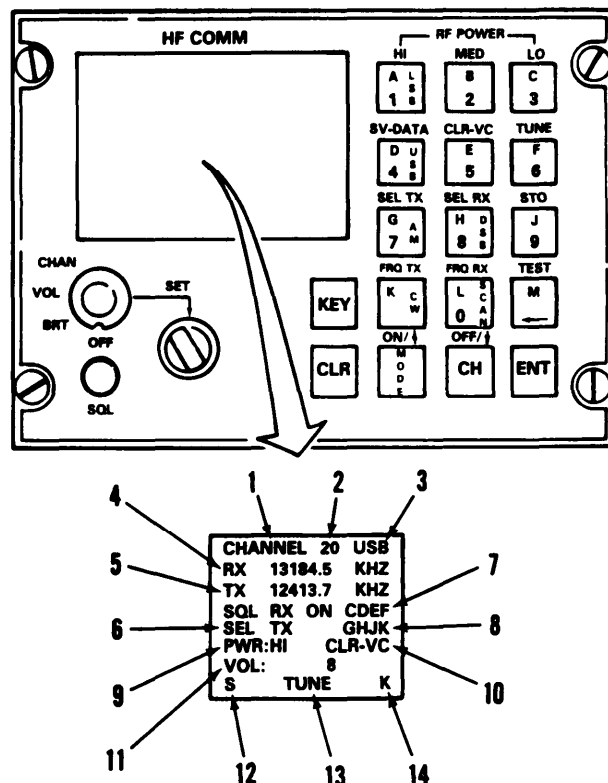
displayed. This identifies the faulty unit and provides a maintenance code. The test is initiated by pressing KEY + TEST + ENT.

**STORE**  
ENT key, used to terminate mode changes, does not automatically store channel information; therefore, a store sequence is provided. The key sequence is: KEY + STO + ENT.

CONTROLS/ INDICATOR	FUNCTION
------------------------	----------

**SCAN**  
Displayed channels may be placed on scan list by pressing SCAN + ON + ENT. It can be removed from scan list by pressing SCAN + OFF + ENT. To automatically scan those channels which have been placed on scan list, press the SCAN key, then ENT key.

**CW Keying**  
To utilize the CW keying function, first place the radio in CW mode. This is accomplished by pressing the following key sequence : MODE + CW + ENT. Now either the KEY key on the control panel, or any external key switch (a mic key) may be used to transmit CW.



23327

Figure 3-7. Control/Display Panel, HF Radio Set (AN/ARC-HF-SSB 199)

**3-18. Voice Security Equipment TSEC/KY-58.**

The voice security equipment is used with the FM band of the No. 1 VHF AM/FM radio to provide secure



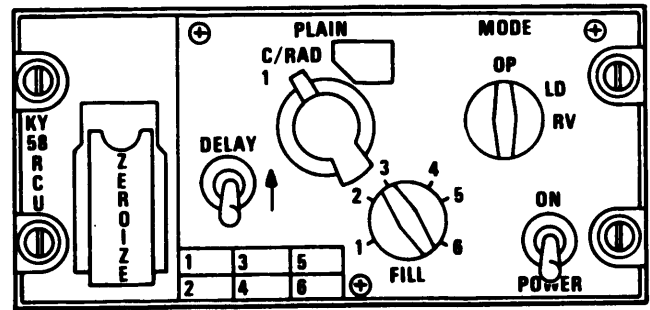
two-way communication. The equipment is controlled by the remote control unit (RCU) Z-AHP mounted on the right side of the console. The POWER switch must be at ON, regardless of the mode of operation, whenever the equipment is installed. Power to operate the voice security system is supplied by the No. 2 DC bus through the COMM KY-28 circuit breaker on the No. 2 PDP.

**3-19. Controls and Function.** (fig. 3-8)

CONTROLS/ INDICATOR	FUNCTION
ZEROIZE Switch (under spring-loaded cover)	Momentary contact toggle switch used to clear (ZEROIZE) any crypto-net variables stored in the TSEC/KY-58.
DELAY Switch	Two position toggle switch; DELAY position used when received signal is to be retransmitted.
PLAIN/C/RAD1 Switch	Two position rotary switch used to select TSEC/KY-58 operating mode. A third position (C/RAD 2) is covered and locked out.
PLAIN	Permits normal (unsecured) communications on associated FM radio set.
C/RADI	Permits secured communications on associated FM radio set.
FILL Switch	Six position, rotary switch, used to select any of six storage registers for storage of crypto-net variable (CNV).
MODE Switch	Three position rotary switch used to select the operating/loading mode of the TSEC/KY-58.
OP	Allows normal operation of KY-58.
LD	Allows normal loading of CNV.
RV	Allows remote loading of CNN.
POWER ON Switch Position	Two position toggle switch used to apply power to TSEC/KY-58.

**3-20. Normal Operation.**

- a. Operating procedures for secure voice.



9137

**Figure 3-8. Remote Control Unit TSEC/KY-58 (Z-AHP)**

**NOTE**

To talk in secure voice, the KY-58 must be loaded with any number of desired variables.

- (1) Set the MODE switch to OP.
  - (2) Set the FILL switch to the storage register which contains the required CNV.
  - (3) Pull out and lift up the POWER switch to ON. A beeping tone and background noise will be heard in the headset. Before the set can be used, the tone must be cleared by momentarily keying the No. 1 VHF AM/FM radio with the PTT switch.
  - (4) Set the PLAIN C/RAD1 switch to C/RAD1.
  - (5) If the signal is to be retransmitted, pull out and lift up the DELAY switch to (ON).
  - (6) Clear voice procedures: To operate in clear voice (plain text) simply:
    - (a) Set the PLAIN-C/RAD switch to PLAIN.
    - (b) Operate the equipment.
- b. Zeroizing procedures.

**NOTE**

Instructions should originate from the net controller or commander as to when to zeroize the equipment.

- (1) Lift the red ZEROIZE switch cover.
  - (2) Push the spring-loaded ZEROIZE switch up. This will zeroize positions 1-6.
  - (3) Close the red cover. The equipment is now zeroized and secure voice communications are no longer possible.
- c. Automatic remote keying procedures.

**NOTE**

Automatic remote keying (AK) causes an old CNV to be replaced by a new CNV. Net controller simply transmits the new CNV over the air to your KY-58.

- (1) The net controller will use a secure voice channel, with directions to stand by for an AK transmission. Calls should not be made during this stand-by action.
- (2) Several beeps will be heard in the headset. This means that the old CNV is being replaced by a new CNV.
- (3) Using this new CNV, the net controller will ask for a radio check.
- (4) After the radio check is completed, the net controller instructions will be to resume normal communications. No action should be taken until the net controller requests a radio check.

d. Manual remote keying procedures. The net controller will make contact on a secure voice channel with instructions to stand by for a new CNV by a manual remote keying (MK) action. Upon instructions from the net controller:

- (1) Set the FILL switch to position 6. Notify the net controller by radio and stand by.
- (2) When notified by the net controller, set the MODE switch to RV (receive variable). Notify the net controller and stand by.
- (3) When notified by the net controller, set the FILL switch to any storage position selected to receive the new CNV (may be unused or may contain the variable being replaced). Notify the net controller and stand by.

**NOTE**

When performing step (3), the storage position (1 through 6) selected to receive the new CNV may be unused or it may contain the variable which is being replaced.

- (4) Upon instructions from the net controller:
  - (a) Listen for a beep on your headset.
  - (b) Wait two seconds.
  - (c) Set the MODE switch to OP.
  - (d) Confirm.
- (5) If the MK operation was successful, the net controller will now contact you via the new CNV.
- (6) If the MK operation was not successful, the net controller will contact you via clear voice (plain) transmission, with instructions to set your FILL selector switch to position 6 and stand by while the MK operation is repeated.

e. It is important to be familiar with certain KY-58 audio tones; Some tones indicate normal operation while others indicate equipment malfunction. These tones are heard only in the cipher mode and are:

- (1) Continuous beeping, with background noise, is a crypto alarm. This occurs when power is first

applied to the KY-58 or when the KY-58 is zeroized. This beeping is part of normal KY-58 operation but must be cleared by momentarily keying the No. 1 VHF AM/FM Radio before communications can be achieved.

- (2) Background noise indicates that the KY-58 is working properly. This noise should occur at power on of the KY-58 and when the KY-58 is generating a cryptovisible. If the background noise is not heard at power on, the equipment must be checked out by maintenance personnel.

- (3) Continuous tone should indicate a parity alarm. This will occur whenever an empty storage register is selected while holding the PTT button in. This tone can mean any of three conditions:

- (a) Selection of an empty storage register.
- (b) A bad cryptovisible is present.

- (c) Equipment failure has occurred. To clear this tone, follow the loading procedures in TM 11-5810-262-0P. If this tone continues, have the equipment checked out by maintenance personnel.

- (4) Continuous tone could also indicate a crypto alarm. If this tone occurs at any time other than in (3) above, equipment failure may have occurred. To clear this tone, repeat the loading procedures in TM 11-5810-262-0P. If this tone continues, have the equipment checked out by maintenance personnel.

- (5) Single beep, when DELAY switch is down, (not selected), can indicate any of three normal conditions:

- (a) Each time the PTT button is pressed when the KY-58 is in C (cipher) and a filled storage register is selected, this tone will be heard. Normal use (speaking) of the KY-58 is possible.

- (b) When the KY-58 has successfully received a cryptovisible, this tone indicates that a good cryptovisible is present in the selected register.

- (c) When you begin to receive a transmission, this tone indicates that the received signal is in secure voice.

- (6) A single beep, when the DELAY switch is up (time delay) occurring after the preamble is sent, indicates that you may begin speaking.

- (7) A single beep, followed by a burst of noise and a seemingly dead condition, indicates that your receiver is on a different variable than the distant transmitter. If this tone occurs when in C/RAD1: Turn FILL switch to the CNV, Plain-Cipher switch to PLAIN, and contact the transmitter in clear text and agree to meet on a particular variable.

**3-21. Voice Security Equipment TSEC/KY-75.**

Voice security equipment (TSEC/KY-75), whenever installed, provides two-way clear or secure voice communication for the HF radio system (AN/ARC-199). Power to operate the voice security equipment is supplied by the No. 2 DC bus through the KY-75 circuit breaker located on the No. 2 PDP.

**3-22. Controls and Function, Voice Security Equipment (TSEC/KY-75).**

(Refer to TM 11-5810-281-OP).

**3-23. Normal Operations, Voice Security Equipment (TSEC/KY-75).**

(Refer to TM 11-5810-281-OP).

**3-23.1. HF Radio Set (AN/ARC-220).**

The HF radio set (AN/ARC-220) provides communication in a 28MHz high frequency band between 2.0 and 29.9999 MHz. Channels are spaced at 100-Hz increments, giving 280,000 possible frequencies. Preset channels can be manually programmed or preprogrammed as part of the communications mission load information. A total of 72 channels can be programmed: 20 manual simplex or half-duplex, 20 programmable simplex or half-duplex, 20 programmable ALE scan lists, and 12 programmable ECCM hop-sets (with ALE capability). Operating modes of the HF radio set using either simplex or half-duplex operation are Upper and Lower sideband (USB, LSB), amplitude modulation equivalent (AME), and continuous wave (CW). Data may be transmitted or received in USB or LSB modes. Both standard and advanced narrow-band digital voice terminal (ANDVT) are supported. DC power to operate the HF radio set is supplied by the No. 2 DC bus through the COMM ARC-220 HF circuit breaker on the No. 2 PDP.

**3-23.2. Controls and Function, HF Radio Set (AN/ARC-220). (fig. 3-7.1)**

<u>CONTROLS/ INDICATOR</u>	<u>FUNCTION</u>
Cursor (1)	Four pushbutton switches position the cursor vertically or horizontally.
Display (2)	NVG compatible, contains six lines. Each line holds up to 20 characters. 15 characters are left justified for communications, advisory, and status information. 5 characters are right justified for control selection.

<u>CONTROLS/ INDICATOR</u>	<u>FUNCTION</u>
Line-select (3)	Pushbutton switches to select options displayed to left of each switch.
Brightness (4)	Pushbutton switches to vary display brightness.
Channel/Net Selector (5)	Seven-position rotary switch used to select programmed operating channels or nets.
<b>Data</b> Connector (6)	Interfaces ARC-220 system to data transfer device for datafill.
<b>Key</b> Connector (7)	Interfaces ARC-220 system to data transfer device for keyfill.
Mode Switch (8)	Five-position rotary switch selects mode of operation.
<b>MAN</b>	Selects HF conventional communications. Operating frequency and emission mode are selected manually. Selected information can be stored in preset channels for future recall.
<b>PRE</b>	Selects conventional HF communications. Channel/net selector is used to select a preprogrammed preset channel. Frequency and emission mode cannot be changed during preset operation.
<b>ALE</b>	Selects automatic link establishment mode of operation.
<b>ECCM</b>	Selects electronic counter-countermeasure mode of operation.
<b>EMER</b>	Used during emergency to place a distress call. The mode, frequency, net, etc., is determined by the datafill.
<b>SQL</b> (9)	Two pushbutton switches which controls squelch and audio muting.

<u>CONTROLS/ INDICATOR</u>	<u>FUNCTION</u>
<b>VOL</b> (10)	Eight-position rotary switch varies the receive audio output level.
Function Switch (11)	Five-position rotary switch selects system operation function.
<b>OFF</b>	Turns the ARC-220 off.
<b>STBY</b>	Selects the standby function where built-in test (BIT), setup, or fill operations can be performed.
<b>SILENT</b>	Used in ALE or ALE ECCM modes to prevent the ARC-220 from automatically responding to incoming calls.
<b>T/R</b>	Allows the ARC-220 to transmit and receive in the selected mode of operation.
<b>ZERO</b>	Erases all data (including datafill and keyfill) which has been loaded into the system
<b>Value</b> (12)	Two pushbutton switches increments a field value or single character value, depending on cursor position.

**3-23.3. Display Lines, HF Radio Set (AN/ARC-220).**

The information displayed on each line is dependent upon the operation being performed. This section specifies what information can be displayed on each particular line.

<u>CONTROLS/ INDICATOR</u>	<u>FUNCTION</u>
Line 1	Alpha-numeric display of 15 characters maximum containing channel title (call sign). Default value - Mode:channel#.
Line 2 ALE Address	Alpha-numeric display of 15 characters maximum containing the Call To (ADRS: xxx) or Self (SELF: xxx) Address. (ADRS:) and (SELF:) labels are removed for addresses greater than 10 characters in length.
Noise Reduction	Character display (ON, OFF) having a display format of - NOISE REDUCE: xxx. Default value is ON.

<u>CONTROLS/ INDICATOR</u>	<u>FUNCTION</u>
Fill Type	Character display (KEY, DATA) having a display Format - TYPE: xxxx x. Default is DATA.
Contention Control	Character display (ON, OFF) having a display format of - LBC: xxx. Default is OFF.
Line 3	
Receive Frequency	Numeric display (2.0 to 29.9999 MHz) with a display format of: RCV xx.xxxx.
ECCM Station Type	Character display (MEMBER, ALTERNATE, MASTER, NET ENTRY, ALT NET ENT). Default is MEMBER.
Lines 3,4	
	Character display of emission mode (USB, LSB, AME, CW) one space to right of frequency. Default is USB.
Line 4	
Transmit Frequency	Numeric display (2.0 to 29.9999 MHz) with a format of: XMT xx.xxxx.
Time	Numeric display (00:00:00 to 23:59:59) with a format of - Hour:Minute:Second.
Line 5	
Link Protection	Character display (OFF, ON) with a format of - LINK PROT: xxx. Default is ON (OFF if no link protection datafill).
Date	Alphanumeric display (01 JAN 00 to 31 DEC 99) with format of - dd MMM yy.
Antenna Type	Character display (T/R, RCV) with format of - ANT: x xx. Default is T/R.
Line 6	
Power Level	Character display (LOW, MED, HIGH) with format of - PWR: xxxx, Default is HIGH.
Squelch	Alpha-numeric display (TONE, 0 to 5) with format of - SQ: xxx.
Volume	Numeric display (1 to 8) with format of - VOL: x.
Listen Before Talk	Character display (ON, OFF) with format of - LBT: xxx. Default value is OFF.

**3-23.4. Operating Modes/Functions, HF Radio Set (AN/ARC-220). (fig. 3-7.1)**

CONTROLS/ INDICATOR	FUNCTION
Power ON/OFF System Turn-On	On Function Switch Turning the Function Switch clock-wise from Off to STBY rns system on and selects standby function. <b>SYSTEM TESTING</b> is displayed while power-up BIT (P-BIT) is in process. <b>SYSTEM-GO</b> will be displayed if all tests good, <b>SYSTEM-NOGQ</b> if not.
CRT Brightness	Two pushbutton switches used to vary brightness. The ↑ (up arrow) increases intensity while the ↓ (down arrow) decreases intensity.
Audio Volume	Eight-position rotary switch varies output level. Setting is displayed on line 6 (bottom) of display for 5 seconds when system first turned on or when <b>VOL</b> setting is changed. The display level are 1, 2, 3 thru 8
Channel Selection	Channel number may be changed using the Channel Selector seven-position rotary switch. The + position of the greater to be selected using the <b>VALUE</b> switch.
Modulation Mode	Four modes are available: USB, LSB, AME, and CW. To change modes, depress the <b>EDIT</b> line select switch. While in the Edit screen use the <b>CURSOR</b> switches to position cursor under the appropriate emission mode (RCV or XMT). Use the <b>VALUE</b> switches to change mode. (Note: The XMT mode will automatically change with the RCV mode, but the reverse is not true). Depress <b>RTN</b> line select switch to enter the edited data and return to operational mode.
Receive/Transmit Frequency	2.0 - 29.9999 MHz, programmable in 100 Hz steps. To change frequencies, depress the <b>EDIT</b> line select switch. While in the Edit screen use

CONTROLS/ INDICATOR	FUNCTION
	the <b>CURSOR</b> switches to position cursor under the appropriate frequency. Use the <b>VALUE</b> switches to change frequency. (Note: The XMT frequency will automatically change with the RCV frequency, but the reverse is not true).
Squelch Level/ Audio Muting	Two pushbutton switches - <b>SQL</b> +, when pressed displays the squelch status on line 6 of display for 5 seconds. Settings are <b>TONE</b> and <b>0</b> through <b>5</b> . <b>TONE</b> provides no muting and no squelch. Position <b>0</b> provides muting but no squelch. Positions <b>1</b> through <b>5</b> provide muting and increasing levels of squelch. Muting is normally enabled during ALE and ALE ECCM operation.
Output Power Level	Three output levels are selectable for the display screen by using the <b>EDIT</b> line-select switch, which brings up the edit mode, moving the cursor under the power character field and using the <b>VALUE</b> switches to change the field. Depress the <b>RTN</b> line-select switch which stores the change and returns to normal operating mode. There are two Built-in-Test (BIT) features which concerns the operator, P-BIT and C-BIT. The Power-Up Bit (P-Bit) tests the ARC-220 when initially turned on. P-Bit exercise basic radio control functions which must be operational prior to entering a system operational mode. A GO/NO-GO status appears on the display and defaults to standby mode upon completion. When NO-GO status appears, depressing the <b>INOP</b> line-select switch displays <b>INOP MODES</b> so an operator can see if limited capability exists. The Continuous Bit (C-BIT) is

CONTROLS/ INDICATOR	FUNCTION
	automatically performed during system operation without any operator intervention. Critical system functions are monitored. Any failures cause a NO-GO advisory, accompanied by the portion of system which failed, to appear on line 5 of the display. C-Bit failures are stored in nonvolatile memory.
STORE	RTN line-select key, used to terminate edit mode, automatically stores any change(s) made.
DataFill	Contains preset frequencies, scan lists, addresses, data messages and ALE and/or ECCM parameters. With system in <b>STBY</b> , press the <b>FILL</b> line-select switch. Use <b>VALUE</b> switches to select <b>DATA</b> in the fill <b>TYPE:</b> field (line 2). Connect data transfer device (DTD) of <b>DATA</b> connector on radio set control front panel and initiate fill from the DTD. <b>LOADING</b> is displayed during datafill. <b>LOAD COMPLETE</b> is displayed for a successful fill, <b>LOAD FAIL</b> displayed if fill cannot be completed. (NOTE: using an AN/CYZ-10 DTD, the radio set control displays <b>DTD DETECTED</b> when DTD is detected). A copy of loaded datafill can be sent to DTD by pressing <b>COPY</b> line-select switch. <b>COPYING</b> is displayed during operation, <b>COPY COMPLETE</b> displayed if successful, <b>COPY FAIL</b> if copy cannot be completed. Press <b>RTN</b> line-select switch to return to <b>STBY</b> screen when datafill is complete. Disconnect the DTD.
KeyFill	Loads secure keys. From <b>STBY</b> screen, press <b>FILL</b> line-select switch. Use <b>VALUE</b> switches to select <b>KEY</b> in fill <b>TYPE:</b> field. Connect DTD to <b>KEY</b>

CONTROLS/ INDICATOR	FUNCTION
	connector on radio set control front panel. Use the <b>VALUE</b> right arrow switch to select key number ( <b>1</b> through <b>6</b> ) to be loaded. Initiate key-fill from DTD. <b>LOADING</b> is displayed during keyfill, <b>LOAD COMPLETE</b> if successful, <b>LOAD FAIL</b> if may cause interference to other stations. Default is <b>ON</b> . <b>LBT:</b> (listed before talk) - This field is used for manual, preset, or conventional (non-ALE) ECCM operation and turns <b>LBT ON</b> or <b>OFF</b> . When <b>OFF</b> , transmission is accomplished without regard to traffic and may cause interference to other stations. Default is <b>OFF</b> . <b>ANT:</b> (antenna) - Useful if system uses both receive-only and transmit/receive antennas. When <b>T/R</b> is selected, the system transmits and receives on same antenna. When <b>RCV</b> is selected, the system transmits on one and receives on the other antenna. Default is <b>T/R</b> . <b>LINK PROT:</b> (link protection) - This field turns ALE link protection <b>ON</b> or <b>OFF</b> . Default is <b>ON</b> ( <b>OFF</b> if no link protection datafill). Press <b>RTN</b> line-select switch when setup edit is complete to enter all data and return to <b>STBY</b> screen.
General Editing	Select desired channel and press the <b>EDIT</b> line-select switch. Use the <b>CURSOR</b> switches to position cursor under character position or data field to be edited. Use <b>VALUE</b> switches to change the character or data field to desired value. If available, the data setup can be modified by pressing the <b>DATA</b> line-select switch in the <b>EDIT</b> screen, using the <b>VALUE</b> switches to scroll through the list of modem set configurations. Press the

CONTROLS/ INDICATOR	FUNCTION	CONTROLS/ INDICATOR	FUNCTION
Transmit Position Report	<p><b>RTN</b> line-select switch when all changes are complete to store the changes and return to normal operation mode.</p> <p>Set function switch to <b>T/R</b> and mode switch to proper mode. Press the <b>POSN</b> line select switch. (NOTE: <b>POSN</b> line-select is available only if configuration data indicates GPS is installed).</p>	Normal ALE Communication Receiving	<p>be performed. If ALE data is not loaded for the selected scan list, a <b>CHANNEL INOP</b> advisory is displayed). Use <b>-SQL+</b> switch to set squelch to <b>TONE</b>. Adjust <b>VOL</b> for comfortable listening level. Use <b>-SQL+</b> switch to set squelch to <b>0</b>. Headset is muted until a link is established. If channel is noisy, set squelch to <b>1</b>. <b>CONTROLS/</b> Higher squelch levels are not recommended for ALE mode of operation.</p>
Manual Operation	<p>Set function switch to <b>T/R</b> and mode switch to <b>MAN</b>. Use <b>-SQL</b> switch to set squelch to <b>0</b>. Adjust <b>VOL</b> control to a comfortable listening level. Use <b>SQL +</b> switch to set squelch to <b>1</b>, the optimum for manual mode. If radio breaks in and out of squelch, increase as required. Set to desired channel. Press microphone PTT switch, wait until tune tone stops and begin communications. When PTT switch is pressed, the <b>XMT</b> frequency is displayed.</p>	Normal ALE Communication Transmitting	<p>When ALE call is received <b>INCOMING CALL</b> is displayed with the address field displaying caller's ALE address. <b>LINKED</b> is displayed and a short gong tone sounds when an ALE link is established. Communication can now begin. Proper protocol is for calling station to make first transmission.</p>
Preset Operation	<p>Set function switch to <b>T/R</b> and mode switch to <b>PRE</b>. Use <b>-SQL</b> switch to set squelch to <b>0</b>. Adjust <b>VOL</b> control for comfortable listening level. Use <b>SQL +</b> switch to set squelch to position <b>1</b>, the optimum setting for preset mode. If radio breaks in and out of squelch, increase as required. Set to desired channel. Press microphone PTT switch, wait until tune tone stops and begin communications. When PTT switch is pressed, the <b>XMT</b> frequency is displayed.</p>		<p>Select ALE address to be called by doing a, b, or c:</p> <ol style="list-style-type: none"> <li>Set channel/net switch to desired preprogrammed net.</li> <li>Use <b>VALUE</b> switch to scroll through and select preprogrammed address.</li> <li>Press <b>EDIT</b> line-select switch, then use <b>CURSOR</b> and <b>VALUE</b> switches to manually select an address character-by-character. (NOTE: <b>NET INOP</b> advisory is displayed if a selected channel or net contains: no data or corrupted data; or hardware cannot support the selected mode). Press microphone PTT switch. <b>CALLING</b> is displayed. <b>LINKED</b> is displayed with a short gong tone and headset audio is restored when link established. Start transmission. The system terminates the link and returns to ALE scanning after a period of inactivity (30 seconds typical). GPS position can also be </li></ol>
Normal ALE Communication	<p>Set function switch to <b>T/R</b> and mode switch to <b>ALE</b>. (NOTE: If the selected net is configured for link protection but does <b>not</b> have accurate time, <b>SYNC</b> instead of <b>POSN</b> will appear on display, line 2 right side along with an <b>UNSYNC</b> advisory at bottom of screen. An ALE link protection time sync needs to</p>		

CONTROLS/ INDICATOR	FUNCTION	CONTROLS/ INDICATOR	FUNCTION
ALE Link Protection Time Sync	<p>transmitted by using the steps above plus the Transmit Position Report steps.</p> <p>Press PTT switch or <b>SYNC</b> line-select switch. System returns to scan and the net default address if sync successful, but if unsuccessful press <b>ABORT</b> line-select switch to return to ALE screen.</p>	ECCM Operation - Receiving Calls	<p><b>RCVING PREAMBLE</b> and/or <b>INCOMING CALL</b> is displayed.</p>
ECCM Net Initialization	<p>Set function switch to <b>T/R</b> and mode switch to <b>ECCM</b>. (NOTE: If ECCM data or keys are not loaded for net selected, a <b>CHANNEL INOP</b> advisory is displayed). Set channel/net switch to desired net. If selected channel is an ALE/ECCM channel, the address of station being called is displayed on line two. (NOTE: <b>NET INOP</b> advisory is displayed if selected channel or net contains: no or corrupted data; or hardware cannot support selected mode. If screen displays <b>UNTUNED</b> or <b>UNSYNC</b> advisories proceed with system Tune/Sync operation, otherwise proceed with ECCM operation.</p>	ECCM Operation - Transmitting	<p>Press microphone PTT switch. Wait for preamble tones to cease then begin communications. If an ALE/ECCM channel is used, <b>CALLING</b> is displayed while call is in process. <b>LINKED</b> is displayed and a short gong tone sounds, and headset audio restored when link established. (NOTE: Press <b>ABRT</b> line-select switch to abort calling process). Call initiator should make first transmission. The system terminates link and returns to scan after a period of inactivity (30 seconds typical). GPS position can also be transmitted by using the steps above plus the Transmit Position Report steps.</p>
ECCM Tune/Sync Operation	<p>Press either the <b>TUNE</b> line-select switch or microphone PTT switch to initiate combined tune and sync. <b>TUNING</b> followed by <b>SYNCING</b> is displayed during process. System will return to ECCM screen without <b>UNTUNED</b> and/or <b>UNSYNC</b> advisories if successful.</p>	Data Messages	<p>The ARC-220 radio set can store up to 10 transmit and 10 received data messages up to 500 characters long each. Received data messages are stored in memory and can be retransmitted. An advisory alerts when a data message is received. Data can be transmitted or received in any mode (manual, ALE, or ECCM). Procedure to send/receive (recall) messages is the same for all modes, except in manual mode when an ALE link is not established.</p>
ECCM Operation	<p>Use <b>-SQL</b> switch to set squelch to <b>TONE</b>. Adjust <b>VOL</b> control for comfortable listening level. Use <b>SQL+</b> switch to set squelch to <b>0</b>. If channel is noisy, set to <b>1</b>. Higher settings are <b>not</b> recommended for ECCM operation.</p>	Data Messages - Received	<p>Received messages are stored in MSG location 1. MSG 10 is the oldest message and is deleted from memory upon receipt of an incoming message. Received messages can be read and/or forwarded, but <b>not</b> edited. A <b>CHECK MSG</b> advisor is displayed when data message received. To recall data messages, perform the following:</p>



CONTROLS/  
INDICATOR

FUNCTION

1. Press **MSG** line-select switch to view message. If operator desires to check messages even though a **CHECK MSG** advisory was not displayed, press **MSG** line-select switch, then **RCVD** line-select switch to view messages. **NO MESSAGES** advisory appears if no messages exist.
2. Use the **CURSOR** up/down arrows to view message one line at a time and left/right arrows to move cursor to left margin. Use **VALUE** switches to page up or down.
3. To view additional messages, use **CURSOR** switches to position cursor under the MSG number the use **VALUE** switches to scroll to next consecutive message number.
4. To retain messages in memory, press the **RTN** line-select switch.
5. To delete messages, position cursor under message number to delete, press the **DEL** line-select switch until **NO MESSAGES** is displayed. Press **RTN** line-select switch to return to operational mode.

Press **SEND** line-select switch to transmit last selected address in ALE or ECCM mode, or to transmit message using current mode and frequency in manual mode. In ALE or ECCM modes advisories are displayed during tuning, synching and linking which is done automatically. **SENDING DATA** is displayed while message is transmitted.

Data Messages -  
Transmit

CONTROLS/  
INDICATOR

FUNCTION

Program/Edit  
Data Messages

Press the **MSG** line-select switch to go to **MESSAGE** screen, then press **PGRM** line-select switch. **NO MESSAGES** is displayed if none exists. Use the **CURSOR** up/down arrows to position the cursor, then use **VALUE** switches to enter desired data (if a previously programmed message is to be edited, use **CURSOR** and **VALUE** switches to obtain appropriate message and line as described earlier). To delete a character in cursor position and to shift remaining characters one position to left, press **DEL** line-select switch. A built-in word dictionary is available (either default or filled). To access word dictionary, press **WORD** line-select switch to obtain **INSERT** screen. Use **CURSOR** and **VALUE** switches to scroll dictionary. Place cursor under desired word and press **SELCT** line-select switch to insert a blank and the selected word at cursor position of message edit screen or if no word found, press **CANCL** line-select switch to return to edit **CONTROLS**/screen. When complete, press **RTN** line-select switch to load message into memory and to return to top-level screen. Shutdown Procedures Set function switch to **OFF**. Gently pull and turn function switch to zeroize **(ZERO)** position to erase preprogrammed information, including all fills. Zeroize function is operational regardless if system is on or off.

CONTROLS/ INDICATOR	FUNCTION
Emergency Communication	The mode used during emergencies is determined by the datafill. The equipment operates normally for mode selected. Set mode switch to <b>EMER</b> . Press the PTT switch to transmit. If in ALE mode, an ALE call is placed to the selected address.

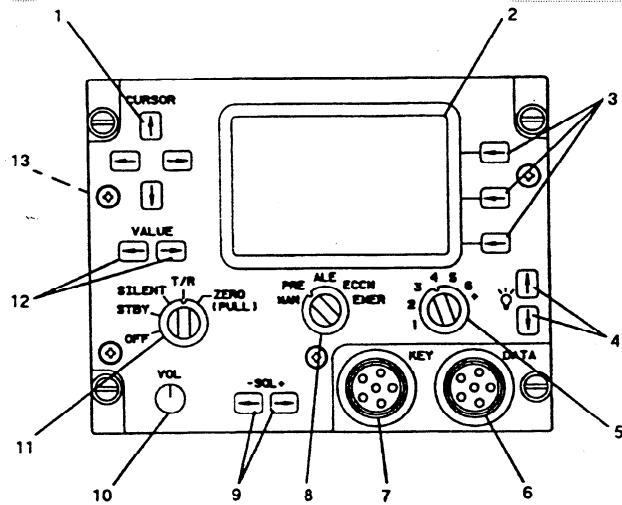


Figure 3-7.1. Control/Display Panel, HF Radio Set (AN/ARC-220)

**3-23.5. Voice Security Equipment TSEC/KY-100.**

Voice security equipment (TSEC/KY-100), when installed, provides two-way clear or secure half-duplex voice/data communication for the HF radio system (AN/ARC-220). Power to operate the TSEC/KY-100 is supplied by the No. 2 DC bus through the HF KY-100 circuit breaker located on the No. 2 PDP.

**3-23.6. Controls, Indicators, Connectors and Function (TSEC/KY-100, Z-AVH). (fig 3-8.1)**

CONTROLS/ INDICATOR	FUNCTION
MODE Switch	Six position rotary switch used to select one of the operational modes.
PT	Plaintext mode. Allows reception or transmission of unencrypted analog voice.
EB	Emergency Back-up mode. Uses the emergency back-up key to encrypt voice for transmission or reception.

CONTROLS/ INDICATOR	FUNCTION
CT	Ciphertext mode. Allows transmission of encrypted voice or data and reception of encrypted or unencrypted voice or data, and non-cooperative terminal rekeying.
RK	Remote Keying mode. Permits KY-100 to perform automatic and manual rekey operations.
OFFLINE	Disables communications and gives access to the system of menus used to select mode settings, self-test features, and filling the KY-100 with crypto-variables.
Z ALL (PULL)	Zeroize mode. Erases all cryptographic data stored in the KY-100 except the Emergency Back-up Key.
CIK Receptacle	Interfaces with a Cryptographic Ignition Key which is needed to enable all secure voice and data communications. <b>This function is currently disabled.</b>
DSPL/OFF BRT Control	Two-function rotary switch which controls the on/off status and backlight intensity of the LCD display.
PNL/OFF BRT Control	Two-function rotary switch which controls the on/off status and backlight intensity for the overall front panel.
PRESET Switch	Rotary selector switch which controls unit operating power and settings which are stored in memory.
OFF	Removes power from KY-100.
MAN	Manual position which allows operating modes to be selected using both OFFLINE and on-line menu system,
1 thru 6	Six separate preset modes which can only be set up in the OFFLINE mode.
FILL Connector	Used to load cryptographic keys through the use of a common fill device such as KYK-13/TSEC Electronic Transfer Device, KYX-15/TSEC Net Control Device, AN/CYZ-10 Data Transfer

<u>CONTROLS/ INDICATOR</u>	<u>FUNCTION</u>
	Device (DTD), or the KOI-18/TSEC General Purpose Tape Reader.
Three Button Keypad	Momentary pushbutton switches active in both OFFLINE and on-line modes. Used to enter and exit submenus, activate the selected mode, select fields, and to scroll through menus and options.
INIT	Initiate switch. In the OFFLINE mode it activates the displayed menu mode and provides entry into submenus. In on-line modes (CT, RK, EB, PT), it selects the display field to be changed.
up Arrow (↑) Switch	In the OFFLINE mode, it is used to scroll through menus from top to bottom. In on-line modes (CT, RK, EB, PT), it is used to scroll through available options for the display field being changed.
Right Arrow (→) Switch	In the OFFLINE mode, it is used to scroll through menus from bottom to top. In the on-line modes (CT, RK, EB, PT) it is used to select the display field to be changed.
Simultaneous (↑→) Display, LCD	Used to exit a submenu. Back-lighted Liquid Crystal Display (LCD) indicates operational status, operator prompts and messages

**3-23.7. Display Annunciators/Fields (TSEC/KY-100, Z-AVH).** (fig 3-8.1)

<u>CONTROLS/ INDICATOR</u>	<u>FUNCTION</u>
TX Annunciator (1)	Displayed when KY-100 is transmitting.
RX Annunciator (2)	Displayed when KY-100 is receiving.
Wb Annunciator (3)	Displayed when KY-100 is in the Wideband (VINSON) configuration.
Nb Annunciator (4)	Displayed when KY-100 is in the Narrowband (ANDVT) configuration.

<u>CONTROLS/ INDICATOR</u>	<u>FUNCTION</u>
Eb Annunciator (5)	Displayed when MODE control switch is in the Emergency Backup (EB) position.
Alphanumeric Display (6)	Provides prompts, messages, and mode indications.
PT Annunciator (7)	Displayed when KY-100 is processing plaintext voice.
Key Symbol (8)	Displayed when menu system is locked.
D Annunciator (9)	Displayed when in Data mode.
V Annunciator (10)	Displayed when in Voice mode.
Rate Display (12)	3-character display indicates voice or data rate.

**3-23.8. Turn-On Procedures.**

When the KY-100 is turned on, tests are automatically performed to determine the equipment's operating status. The results of these tests will be presented on the display. Also, a **CLd START** message will be displayed.

a. Cold start turn-on. (Initiated if no traffic encryption key (TEK) is contained in the KY-100).

(1) Turn on the KY-100 by turning the PRESET switch to the MAN position.

(2) The KY-100 will initiate a self-test. The display reads **CLd STRT** and then **PSH INIT**.

(3) Connect a fill device to the KY-100 fill connector using a fill cable. Select the fill position containing the valid key and turn it on.

(4) Press the INIT pushbutton (PUSH INIT).

(5) The KY-100 displays **KEY 1 01, PASS, WORKING, LOCKED, READY**.

**NOTE**

If a fill device is not connected to the KY-100 when the INIT pushbutton is pressed, a dEV ERR (Device Error) message will be displayed. When this occurs, the only available communication mode will be PT (Plaintext).

(6) If a FAIL message is displayed, notify the next level of maintenance.

(7) To load additional keys (up to a total of 6), proceed to Key Loading Section.

b. Normal turn-on.

(1) Set the front panel MODE control to the OFFLINE position.

(2) Rotate the DSPL and PNL switches clockwise, out of the OFF detent positions and adjust the display and panel lighting for comfortable viewing.

(3) Set the PRESET switch to the MAN (manual) position to apply power to the KY-100 electronics. Power-on tests will automatically be run when primary power is applied.

(4) Upon successful completion of the power-on tests, the test results should appear in the display. If PASS is displayed, continue with the turn-on procedures. However, if a FAIL message appears in the display, notify the next level of maintenance. If **PUSH INIT** is displayed, perform the cold start procedures as described above in paragraph a.

**3-23.9. Key Loading Procedures.**

Key loading may be accomplished using a KYX-15, KYK-13 or a KOI-18. One Key Encryption Key (KEK), up to six Traffic Encryption Keys (TEKs), and one Emergency Backup (EB) key can be loaded in the KY-100. A Fill Cable (ON190191) is required when using one of these devices. Proceed with the following generic Key Loading procedures:

a. Place the KY-100 MODE switch in OFFLINE position.

b. If the KY-100 is not on, turn PRESET switch to MAN position.

c. Connect a fill device to the KY-100 fill connector.

d. Push the ↑ (up arrow) or → (right arrow) button until **KEY OPS** is displayed.

e. Push the INIT button. **LOAD KEY** will be displayed.

f. Push the INIT button. **LOAD N** with a flashing N will be displayed. The flashing N indicates the currently selected key location.

g. Press the ↑ (up arrow) or → (right arrow) button until the required location (1, 2, 3, 4, 5, 6, or U) is displayed.

h. Press the INIT button. The entire **LOAD N** message will now be flashing.

i. Turn on fill device and select key to be loaded.

**NOTE**

**DO NOT** press the INITIATE pushbutton (or pull tape through tape reader) on fill device.

j. Press the INIT button. (When using a KOI-18 pull tape through tape reader at a steady rate after the terminal INIT button is pressed). Upon completion of a successful load, a pass tone will be heard and the display will momentarily indicate **KEY N**, where N is the key location loaded.

k. The display will again show **LOAD N** with N flashing. To load additional keys, repeat steps g. through j. until all desired key locations have been loaded.

l. Turn off and disconnect the fill device from the KY-100.

m. Rotate MODE switch out of OFFLINE to exit Key Load.

**3-23.10. Zeroize Procedures.**

a. Zeroize ALL keys. This procedure is active even if primary Power is removed from the KY-100. All key locations within the KY-100 will be zeroized. Once zeroized, only PT voice communications are possible until a new Traffic Encryption Key (TEK) is loaded.

(1) Pull the MODE switch and rotate it to the Z ALL position. All keys stored in locations 1-6 and U will be erased.

(2) If the KY-100 is on when this procedure is performed, **ZEROED** will be displayed, and a tone will be heard.

(3) If the KY-100 power is on when the MODE switch is rotated out of the Z ALL position, **PUSH INIT** will be displayed. Follow the COLD START procedures.

b. Zeroize SPECIFIC key locations.

(1) Place the KY-100 MODE switch to the OFFLINE position.

(2) If the KY-100 is not on, turn PRESET switch to MAN position.

(3) Push the ↑ (up arrow) or → (right arrow) button until **KEY OPS** is displayed.

(4) Push the INIT button. **LOAD KEY** will be displayed.

(5) Push the ↑ (up arrow) or → (right arrow) button until **ZERO** is displayed.

**3-22. Controls and Function, Voice Security Equipment (TSEC/KY-75).**

(Refer to TM 11-5810-281-OP).

**3-23. Normal Operations, Voice Security Equipment (TSC/KY-75).**

(Refer to TM 11-5810-281-OP).

**3-23.2. HF Radio Set (AN/ARC-220).**

The HF radio set (AN/ARC-220) provides communication in a 28MHz high frequency band between 2.0 and 29.9999 MHz. Channels are spaced at 100-Hz increments, giving 280,000 possible frequencies. Preset channels can be manually programmed or preprogrammed as part of the communications mission load information. A total of 72 channels can be programmed: 20 manual simplex or half-duplex, 20 programmable simplex or half-duplex, 20 programmable ALE scan lists, and 12 programmable ECCM hop-sets (with ALE capability). Operating modes of the HF radio set using either simplex or half-duplex operation are Upper and Lower sideband (USB, LSB), amplitude modulation equivalent (AME), and continuous wave (CW). Data may be transmitted or received in USB or LSB modes. Both standard and advanced narrow-band digital voice terminal (ANDVT) are supported. DC power to operate the HF radio set is supplied by the No. 2 DC bus through the COMM ARC-220 HF circuit breaker on the No. 2 PDP.

**3-23.3. Controls and Function, HF Radio Set (AN/ARC-220). (fig. 3-7.1)**

CONTROLS/ INDICATOR	FUNCTION
Cursor (1)	Four pushbutton switches position the cursor vertically or horizontally.
Display (2)	NVG compatible, contains six lines. Each line holds up to 20 characters. 15 characters are left justified for communications, advisory, and status information. 5 characters are right justified for control selection.

CONTROLS/ INDICATOR	FUNCTION
Line-select (3)	Pushbutton switches to select options displayed to left of each switch.
Brightness (4)	Pushbutton switches to vary display brightness.
Channel/Net Selector (5)	Seven-position rotary switch used to select programmed operating channels or nets.
Data Connector (6)	Interfaces ARC-220 system to data transfer device for datafill.
Key Connector (7)	Interfaces ARC-220 system to data transfer device for keyfill.
Mode Switch (8)	Five-position rotary switch selects mode of operation.
<b>MAN</b>	Selects HF conventional communications. Operating frequency and emission mode are selected manually. Selected information can be stored in preset channels for future recall.
<b>PRE</b>	Selects conventional HF communications. Channel/net selector is used to select a preprogrammed preset channel. Frequency and emission mode cannot be changed during preset operation.
<b>ALE</b>	Selects automatic link establishment mode of operation.
<b>ECCM</b>	Selects electronic counter-countermeasure mode of operation.
<b>EMER</b>	Used during emergency to place a distress call. The mode, frequency, net, etc., is determined by the datafill.
SQL (9)	Two pushbutton switches which controls squelch and audio muting.

CONTROLS/ INDICATOR	FUNCTION
<b>VOL</b> (10)	Eight-position rotary switch varies the receive audio output level.
Function Switch (11)	Five-position rotary switch selects system operation function.
<b>OFF</b>	Turns the ARC-220 off.
<b>STBY</b>	Selects the standby function where built-in test (BIT), setup, or fill operations can be performed.
<b>SILENT</b>	Used in ALE or ALE ECCM modes to prevent the ARC-220 from automatically responding to incoming calls.
<b>T/R</b>	Allows the ARC-220 to transmit and receive in the selected mode of operation.
<b>ZERO</b>	Erases all data (including datafill and keyfill) which has been loaded into the system
<b>Value</b> (12)	Two pushbutton switches increments a field value or single character value, depending on cursor position.

**3-23.4. Display Lines, HF Radio Set (AN/ARC-220).**

The information displayed on each line is dependent upon the operation being performed. This section specifies what information can be displayed on each particular line.

CONTROLS/ INDICATOR	FUNCTION
Line 1	Alpha-numeric display of 15 characters maximum containing channel title (call sign). Default value - Mode:channel#.
Line 2 ALE Address	Alpha-numeric display of 15 characters maximum containing the Call To (ADRS: xxx) or Self (SELF: xxx) Address. (ADRS:) and (SELF:) labels are removed for addresses greater than 10 characters in length.
Noise Reduction	Character display (ON, OFF) having a display format of - NOISE REDUCE: xxx. Default value is ON.

CONTROLS/ INDICATOR	FUNCTION
Fill Type	Character display (KEY, DATA) having a display Format - TYPE: xxxx x. Default is DATA.
Contention Control	Character display (ON, OFF) having a display format of - LBC: xxx. Default is OFF.
Line 3	
Receive Frequency	Numeric display (2.0 to 29.9999 MHz) with a display format of: RCV xx.xxxx.
ECCM Station Type	Character display (MEMBER, ALTERNATE, MASTER, NET ENTRY, ALT NET ENT). Default is MEMBER.
Lines 3,4	Character display of emission mode (USB, LSB, AME, CW) one space to right of frequency. Default is USB.
Line 4	
Transmit Frequency	Numeric display (2.0 to 29.9999 MHz) with a format of: XMT xx.xxxx.
Time	Numeric display (00:00:00 to 23:59:59) with a format of - Hour:Minute:Second.
Line 5	
Link Protection	Character display (OFF, ON) with a format of - LINK PROT: xxx. Default is ON (OFF if no link protection datafill).
Date	Alphanumeric display (01 JAN 00 to 31 DEC 99) with format of - dd MMM yy.
Antenna Type	Character display (T/R, RCV) with format of - ANT: x xx. Default is T/R.
Line 6	
Power Level	Character display (LOW, MED, HIGH) with format of - PWR: xxxx. Default is HIGH.
Squelch	Alpha-numeric display (TONE, 0 to 5) with format of - SQ: xxx.
Volume	Numeric display (1 to 8) with format of - VOL: x.
Listen Before Talk	Character display (ON, OFF) with format of - LBT: xxx. Default value is OFF.

3-23.5. Operating Modes/Functions, HF Radio Set (AN/ARC-220). (fig 3-7.1)

CONTROLS/ INDICATOR	FUNCTION	CONTROLS/ INDICATOR	FUNCTION
Power ON/OFF	On Function Switch		the <b>CURSOR</b> switches to position cursor under the appropriate frequency. Use the <b>VALUE</b> switches to change frequency. (Note: The XMT frequency will automatically change with the RCV frequency, but the reverse is not true).
System Turn-On	Turning the Function Switch clock-wise from Off to STBY ms system on and selects standby function. <b>SYSTEM TESTING</b> is displayed while power-up BIT (P-BIT) is in process. <b>SYSTEM-GO</b> will be displayed if all tests good, <b>SYSTEM-NOGO</b> if not.	Squelch Level/ Audio Muting	Two pushbutton switches - <b>SQL +</b> , when pressed displays the squelch status on line 6 of display for 5 seconds. Settings are <b>TONE</b> and <b>O</b> through <b>5</b> . <b>TONE</b> provides no muting and no squelch. Position <b>0</b> provides muting but no squelch. Positions <b>1</b> through <b>5</b> provide muting and increasing levels of squelch. Muting is normally enabled during ALE and ALE ECCM operation.
CRT Brightness	Two pushbutton switches used to vary brightness. The ↑ (up arrow) increases intensity while the ↓ (down arrow) decreases intensity.		
Audio Volume	Eight-position rotary switch varies output level. Setting is displayed on line 6 (bottom) of display for 5 seconds when system first turned on or when <b>VOL</b> setting is changed. The display level are 1, 2, 3 thru 8.	Output Power Level	Three output levels are selectable for the display screen by using the <b>EDIT</b> line-select switch, which brings up the edit mode, moving the cursor under the power character field and using the <b>VALUE</b> switches to change the field. Depress the <b>RTN</b> line-select switch which stores the change and returns to normal operating mode. There are two Built-in-Test (BIT) features which concerns the operator, P-BIT and C-BIT. The Power-Up Bit (P-Bit) tests the ARC-220 when initially turned on. P-Bit exercise basic radio control functions which must be operational prior to entering a system operational mode. A GO/NO-GO status appears on the display and defaults to stand-by mode upon completion. When NO-GO status appears, depressing the <b>INOP</b> line-select switch displays <b>INOP MODES</b> so an operator can see if limited capability exists. The Continuous Bit (C-BIT) is
Channel Selection	Channel number may be changed using the Channel Selector seven-position rotary switch. The + position of the greater to be selected using the <b>VALUE</b> switch.		
Modulation Mode	Four modes are available: USB, LSB, AME, and CW. To change modes, depress the <b>EDIT</b> line select switch. While in the Edit screen use the <b>CURSOR</b> switches to position cursor under the appropriate emission mode (RCV or XMT). Use the <b>VALUE</b> switches to change mode. (Note: The XMT mode will automatically change with the RCV mode, but the reverse is not true). Depress <b>RTN</b> line select switch to enter the edited data and return to operational mode.		
Receive/Transmit Frequency	2.0 - 29.9999 MHz, programmable in 100 Hz steps. To change frequencies, depress the EDIT line select switch. While in the Edit screen use		

CONTROLS/ INDICATOR	FUNCTION
	automatically performed during system operation without any operator intervention. Critical system functions are monitored. Any failures cause a NO-GO advisory, accompanied by the portion of system which failed, to appear on line 5 of the display. C-Bit failures are stored in nonvolatile memory.
STORE	RTN line-select key, used to terminate edit mode, automatically stores any change(s) made.
DataFill	Contains preset frequencies, scan lists, addresses, data messages and ALE and/or ECCM parameters. With system in <b>STBY</b> , press the <b>FILL</b> line-select switch. Use <b>VALUE</b> switches to select <b>DATA</b> in the fill <b>TYPE:</b> field (line 2). Connect data transfer device (DTD) of <b>DATA</b> connector on radio set control front panel and initiate fill from the DTD. <b>LOADING</b> is displayed during datafill. <b>LOAD COMPLETE</b> is displayed for a successful fill, <b>LOAD FAIL</b> displayed if fill cannot be completed. (NOTE: using an AN/CYZ-10 DTD, the radio set control displays <b>DTD DETECTED</b> when DTD is detected). A copy of loaded datafill can be sent to DTD by pressing <b>COPY</b> line-select switch. <b>COPYING</b> is displayed during operation, <b>COPY COMPLETE</b> displayed if successful, <b>COPY FAIL</b> if copy cannot be completed. press <b>RTN</b> line-select switch to return to <b>STBY</b> screen when datafill is complete. Disconnect the DTD.
KeyFill	Loads secure keys. From <b>STBY</b> screen, press <b>FILL</b> line-select switch. Use <b>VALUE</b> switches to select <b>KEY</b> in fill <b>TYPE:</b> field. Connect DTD to <b>KEY</b>

CONTROLS/ INDICATOR	FUNCTION
	connector on radio set control front panel. Use the <b>VALUE</b> right arrow switch to select key number (1 through 6) to be loaded. Initiate keyfill from DTD. <b>LOADING</b> is displayed during key fill, <b>LOAD COMPLETE</b> if successful, <b>LOAD FAIL</b> if may cause interference to other stations. Default is <b>ON</b> . <b>LBT:</b> (listed before talk) - This field is used for manual, preset, or conventional (non-ALE) ECCM operation and turns <b>LBT ON</b> or <b>OFF</b> . When <b>OFF</b> , transmission is accomplished without regard to traffic and may cause interference to other stations. Default is <b>OFF</b> . <b>ANT:</b> (antenna) - Useful if system uses both receive-only and transmit/receive antennas. When <b>T/R</b> is selected, the system transmits and receives on same antenna. When <b>RCV</b> is selected, the system transmits on one and receives on the other antenna. Default is <b>T/R</b> . <b>LINK PROT:</b> (link protection) - This field turns ALE link protection <b>ON</b> or <b>OFF</b> . Default is <b>ON</b> ( <b>OFF</b> if no link protection datafill). Press <b>RTN</b> line-select switch when setup edit is complete to enter all data and return to <b>STBY</b> screen.
General Editing	Select desired channel and press the <b>EDIT</b> line-select switch. Use the <b>CURSOR</b> switches to position cursor under character position or data field to be edited. Use <b>VALUE</b> switches to change the character or data field to desired value. If available, the data setup can be modified by pressing the <b>DATA</b> line-select switch in the <b>EDIT</b> screen, using the <b>VALUE</b> switches to scroll through the list of modem set configurations. Press the



CONTROLS/ INDICATOR	FUNCTION	CONTROLS/ INDICATOR	FUNCTION
Transmit Position Report	<p><b>RTN</b> line-select switch when all changes are complete to store the changes and return to normal operation mode.</p> <p>Set function switch to <b>T/R</b> and mode switch to proper mode. press the <b>POSN</b> line select switch. (NOTE: <b>POSN</b> line-select is available only if configuration data indicates GPS is installed).</p>	Normal ALE Communication - Receiving	<p>be performed. If ALE data is not loaded for the selected scan list, a <b>CHANNEL INOP</b> advisory is displayed). Use <b>-SQL+</b> switch to set squelch to <b>TONE</b>. Adjust <b>VOL</b> for comfortable listening level. Use <b>-SQL+</b> switch to set squelch to <b>0</b>. Headset is muted until a link is established. If channel is noisy, set squelch to <b>1</b>. <b>CONTROLS/</b> Higher squelch levels are not recommended for ALE mode of operation.</p>
Manual Operation	<p>Set function switch to <b>T/R</b> and mode switch to <b>MAN</b>. Use <b>-SQL</b> switch to set squelch to <b>0</b>. Adjust <b>VOL</b> control to a comfortable listening level. Use <b>SQL +</b> switch to set squelch to <b>1</b>, the optimum for manual mode. If radio breaks in and out of squelch, increase as required. Set to desired channel. Press microphone PTT switch, wait until tune tone stops and begin communications. When PTT switch is pressed, the <b>XMT</b> frequency is displayed.</p>	Normal ALE Communication - Transmitting	<p>When ALE call is received <b>INCOMING CALL</b> is displayed with the address field displaying caller's ALE address. <b>LINKED</b> is displayed and a short gong tone sounds when an ALE link is established. Communication can now begin. Proper protocol is for calling station to make first transmission.</p>
Preset Operation	<p>Set function switch to <b>T/R</b> and mode switch to <b>PRE</b>. Use <b>-SQL</b> switch to set squelch to <b>0</b>. Adjust <b>VOL</b> control for comfortable listening level. Use <b>SQL +</b> switch to set squelch to position <b>1</b>, the optimum setting for preset mode. If radio breaks in and out of squelch. increase as required. Set to desired channel. Press microphone PTT switch, wait until tune tone stops and begin communications. When PTIT switch is pressed, the <b>XMT</b> frequency is displayed.</p>		<p>Select ALE address to be called by doing a, b, or c:                      a. Set channel/net switch to desired preprogrammed net.                      b. Use <b>VALUE</b> switch to scroll through and select preprogrammed address.                      c. Press <b>EDIT</b> line-select switch, then use <b>CURSOR</b> and <b>VALUE</b> switches to manually select an address character-by-character. (NOTE: <b>NET INOP</b> advisory is displayed if a selected channel or net contains: no data or corrupted data; or hardware cannot support the selected mode). Press microphone <b>PTT</b> switch. <b>CALLING</b> is displayed. <b>LINKED</b> is displayed with a short gong tone and headset audio is restored when link established. Start transmission. The system terminates the link and returns to ALE scanning after a period of inactivity (30 seconds typical). GPS position can also be</p>
Normal ALE Communication	<p>Set function switch to <b>T/R</b> and mode switch to <b>ALE</b>. (NOTE: If the selected net is configured for link protection but does not have accurate time, <b>SYNC</b> instead of <b>POSN</b> will appear on display, line 2 right side along with an <b>UNSYNC</b> advisory at bottom of screen. An ALE link protection time sync needs to</p>		

CONTROLS/ INDICATOR	FUNCTION	CONTROLS/ INDICATOR	FUNCTION
	transmitted by using the steps above plus the Transmit Position Report steps.	ECCM Operation - Receiving Calls	<b>RCVING PREAMBLE</b> and/or <b>INCOMING CALL</b> is displayed.
ALE Link Protection Time Sync	Press PTT switch or SYNC line-select switch. System returns to scan and the net default address if sync successful, but if unsuccessful press <b>ABORT</b> line-select switch to return to ALE screen.	ECCM Operation - Transmitting	Press microphone PTT switch. Wait for preamble tones to cease then begin communications. If an ALE/ECCM channel is used, <b>CALLING</b> is displayed while call is in process. <b>LINKED</b> is displayed and a short gong tone sounds, and headset audio restored when link established. (NOTE: Press <b>ABRT</b> line-select switch to abort calling process). Call initiator should make first transmission. The system terminates link and returns to scan after a period of inactivity (30 seconds typical). GPS position can also be transmitted by using the steps above plus the Transmit Position Report steps.
ECCM Net Initialization	Set function switch to <b>T/R</b> and mode switch to <b>ECCM</b> . (NOTE: If ECCM data or keys are not loaded for net selected, a <b>CHANNEL INOP</b> advisory is displayed). Set channel/net switch to desired net. If selected channel is an ALE/ECCM channel, the address of station being called is displayed on line two. (NOTE: <b>NET INOP</b> advisory is displayed if selected channel or net contains: no or corrupted data; or hardware cannot support selected mode. If screen displays <b>UNTUNED</b> or <b>UNSYNC</b> advisories proceed with system Tune/Sync operation, other wise proceed with ECCM operation.	Data Messages	The ARC-220 radio set can store up to 10 transmit and 10 received data messages up to 500 characters long each. Received data messages are stored in memory and can be retransmitted. An advisory alerts when a data message is received. Data can be transmitted or received in any mode (manual, ALE, or ECCM). Procedure to send/receive (recall) messages is the same for all modes, except in manual mode when an ALE link is not established.
ECCM Tune/Sync Operation	Press either the <b>TUNE</b> line-select switch or microphone PTT switch to initiate combined tune and sync. <b>TUNING</b> followed by <b>SYNCING</b> is displayed during process. System will return to ECCM screen without <b>UNTUNED</b> and/or <b>UNSYNC</b> advisories if successful.	Data Messages - Received	Received messages are stored in MSG location 1. MSG 10 is the oldest message and is deleted from memory upon receipt of an incoming message. Received messages can be read and/or forwarded, but not edited. A <b>CHECK MSG</b> advisor is displayed when data message received. To recall data messages, perform the following:
ECCM Operation	Use <b>-SQL</b> switch to set squelch to <b>TONE</b> . Adjust <b>VOL</b> control for comfortable listening level. Use <b>SQL+</b> switch to set squelch to <b>0</b> . If channel is noisy, set to <b>1</b> . Higher settings are not recommended for ECCM operation.		

CONTROLS/  
INDICATOR

FUNCTION

INDICATOR

FUNCTION

Program/Edit  
Data Messages

Press the **MSG** line-select switch to go to **MESSAGE** screen, then press **PGRM** line-select switch. **NO MESSAGES** is displayed if none exists. Use the **CURSOR** up/down arrows to position the cursor, then use **VALUE** switches to enter desired data (if a previously programmed message is to be edited, use **CURSOR** and **VALUE** switches to obtain appropriate message and line as described earlier). To delete a character in cursor position and to shift remaining characters one position to left, press **DEL** line-select switch. A built-in word dictionary is available (either default or filled). To access word dictionary, press **WORD** line-select switch to obtain **INSERT** screen. Use **CURSOR** and **VALUE** switches to scroll dictionary. Place cursor under desired word and press **SELCT** line-select switch to insert a blank and the selected word at cursor position of message edit screen or if no word found, press **CANCL** line-select switch to return to edit CONTROLS/screen. When complete, press **RTN** line-select switch to load message into memory and to return to top-level screen. Shutdown Procedures Set function switch to **OFF**. Gently pull and turn function switch to zeroize

**(ZERO)** position to erase preprogrammed information, including all fills. Zeroize function is operational regardless if system is on or off.

1. Press **MSG** line-select switch to view message. If operator desires to check messages even though a **CHECK MSG** advisory was not displayed, press **MSG** line-select switch, then **RCVD** line-select switch to view messages. **NO MESSAGES** advisory appears if no messages exist.
2. Use the **CURSOR** up/down arrows to view message one line at a time and left/right arrows to move cursor to left margin. Use **VALUE** switches to page up or down.
3. To view additional messages, use **CURSOR** switches to position cursor under the MSG number the use **VALUE** switches to scroll to next consecutive message number.
4. To retain messages in memory, press the **RTN** line-select switch.
5. To delete messages, position cursor under message number to delete, press the **DEL** line-select switch until **NO MESSAGES** is displayed. Press **RTN** line-select switch to return to operational mode. Press **SEND** line-select switch to transmit last selected address in ALE or ECCM mode, or to transmit message using current mode and frequency in manual mode. In ALE or ECCM modes advisories are displayed during tuning, synching and linking which is done automatically. **SENDING DATA** is displayed while message is transmitted.

Data Messages -  
Transmit

CONTROLS/ INDICATOR	FUNCTION
Emergency Communication	The mode used during emergencies is determined by the datafill. The equipment operates normally for mode selected. Set mode switch to <b>EMER</b> . Press the PTT switch to transmit. If in ALE mode, an ALE call is placed to the selected address.

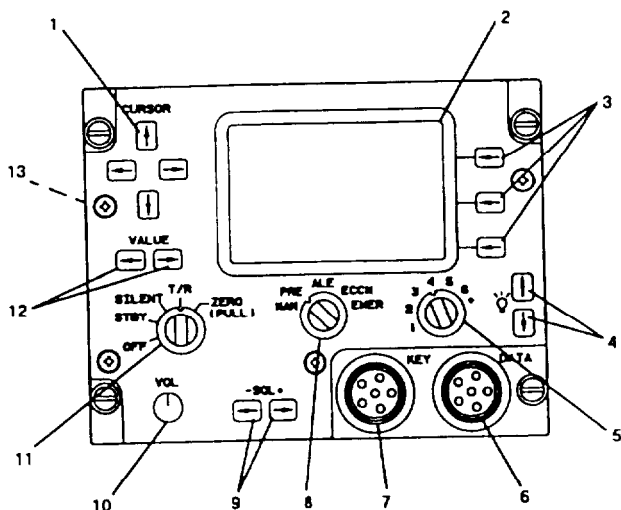


Figure 3-7.1. Control/Display Panel, HF Radio Set (AN/ARC-220)

**3-23.6. Voice Security Equipment TSEC/KY-100.**

Voice security equipment (TSEC/KY-100), when installed, provides two-way clear or secure half-duplex voice/data communication for the HF radio system (AN/ARC-220). Power to operate the TSEC/KY-100 is supplied by the No. 2 DC bus through the HF KY- 100 circuit breaker located on the No. 2 PDP.

**3-23.7. Controls, Indicators, Connectors and Function (TSEC/KY-100, Z-AVH). (fig 3-8.1)**

CONTROLS/ INDICATOR	FUNCTION
MODE Switch	Six position rotary switch used to select one of the operational modes.
PT	Plaintext mode. Allows reception or transmission of unencrypted analog voice.
EB	Emergency Back-up mode. Uses the emergency back-up key to encrypt voice for transmission or reception.

CONTROLS/ INDICATOR	FUNCTION
CT	Ciphertext mode. Allows transmission of encrypted voice or data and reception of encrypted or unencrypted voice or data, and non-cooperative terminal rekeying.
RK	Remote Keying mode. Permits KY-100 to perform automatic and manual rekey operations.
OFFLINE	Disables communications and gives access to the system of menus used to select mode settings, self-test features, and filling the KY-100 with crypto-variables.
Z ALL (PULL)	Zeroize mode. Erases all cryptographic data stored in the KY - 100 except the Emergency Back-up Key.
CIK Receptacle	Interfaces with a Cryptographic Ignition Key which is needed to enable all secure voice and data communications. <b>This function is currently disabled.</b>
DSPL/OFF BRT Control	Two-function rotary switch which controls the on/off status and backlight intensity of the LCD display.
PNL/OFF BRT Control	Two-function rotary switch which controls the on/off status and backlight intensity for the overall front panel.
PRESET Switch	Rotary selector switch which controls unit operating power and settings which are stored in memory.
OFF	Removes power from KY-100.
MAN	Manual position which allows operating modes to be selected using both OFFLINE and on-line menu system.
1 thru 6	Six separate preset modes which can only be set up in the OFFLINE mode.
FILL Connector	Used to load cryptographic keys through the use of a common fill device such as KYK-13/TSEC Electronic Transfer Device, KYX-15/TSEC Net Control Device, AN/CYZ-10 Data Transfer

CONTROLS/ INDICATOR	FUNCTION
	Device (DTD), or the KOI-18/TSEC General Purpose Tape Reader.
Three Button Keypad	Momentary pushbutton switches active in both OFFLINE and on-line modes. Used to enter and exit submenus. activate the selected mode, select fields, and to scroll through menus and options.
INIT	Initiate switch. In the OFFLINE mode it activates the displayed menu mode and provides entry into submenus. In on-line modes (CT, RK, EB, PT), it selects the display field to be changed.
Up Arrow (t) Switch	In the OFFLINE mode, it is used to scroll through menus from top to bottom. In on-line modes (CT, RK, EB, PT), it is used to scroll through available options for the display field being changed.
Right Arrow (+) Switch	In the OFFLINE mode, it is used to scroll through menus from bottom to top. In the on-line modes (CT, RK, EB, PT) it is used to select the display field to be changed.
Simultaneous (↑→) Display, LCD	Used to exit a submenu. Back-lighted Liquid Crystal Display (LCD) indicates operational status, operator prompts and messages

**3-23.8. Display Annunciators/Fields (TSEC/KY-100, Z-AVH). (fig 3-8.2)**

CONTROLS/ INDICATOR	FUNCTION
TX Annunciator (1)	Displayed when KY-100 is transmitting.
RX Annunciator (2)	Displayed when KY-100 is receiving.
Wb Annunciator (3)	Displayed when KY-100 is in the Wideband (VINSON) configuration.
Nb Annunciator (4)	Displayed when KY-100 is in the Narrowband (ANDVT) configuration.

CONTROLS/ INDICATOR	FUNCTION
Eb Annunciator (5)	Displayed when MODE control switch is in the Emergency Backup (EB) position.
Alphanumeric Display (6)	Provides prompts, messages, and mode indications.
PT Annunciator (7)	Displayed when KY-100 is processing plaintext voice.
Key Symbol (8)	Displayed when menu system is locked.
D Annunciator (9)	Displayed when in Data mode.
V Annunciator (10)	Displayed when in Voice mode.
Rate Display (12)	3-character display indicates voice or data rate.

**3-23.9. Turn-On Procedures.**

When the KY-100 is turned on, tests are automatically performed to determine the equipment's operating status. The results of these tests will be presented on the display. Also, a **CLd START** message will be displayed.

a. Cold start turn-on. (Initiated if no traffic encryption key (TEK) is contained in the KY-100).

(1) Turn on the KY-100 by turning the PRESET switch to the MAN position.

(2) The KY-100 will initiate a self-test. The display reads CM STRT and then PSH INIT.

(3) Connect a fill device to the KY-100 fill connector using a fill cable. Select the fill position containing the valid key and turn it on.

(4) Press the INIT pushbutton (PUSH INIT).

(5) The KY-100 displays **KEY 1 01, PASS, WORKING, LOCKED, READY.**

**NOTE**

If a fill device is not connected to the KY-100 when the INIT pushbutton is pressed, a dEV ERR (Device Error) message will be displayed. When this occurs, the only available communication mode will be PT (Plaintext).

(6) If a FAIL message is displayed, notify the next level of maintenance.

(7) To load additional keys (up to a total of 6), proceed to Key Loading Section.

b. Normal turn-on.

(1) Set the front panel MODE control to the OFFLINE position.

(2) Rotate the DSPL and PNL switches clockwise, out of the OFF detent positions and adjust the display and panel lighting for comfortable viewing.

(3) Set the PRESET switch to the MAN (manual) position to apply power to the KY-100 electronics. Power-on tests will automatically be run when primary power is applied.

(4) Upon successful completion of the power-on tests, the test results should appear in the display. If **PASS** is displayed, continue with the turn-on procedures. However, if a FAIL message appears in the display, notify the next level of maintenance. If **PUSH INIT** is displayed, perform the cold start procedures as described above in paragraph a.

**3-23.10. Key Loading Procedures.**

Key loading may be accomplished using a KYX-15, KYK-13 or a KOI-18. One Key Encryption Key (KEK), up to six Traffic Encryption Keys (TEKs), and one Emergency Backup (EB) key can be loaded in the KY-100. A Fill Cable (ON190191) is required when using one of these devices. Proceed with the following generic Key Loading procedures:

- a. Place the KY-100 MODE switch in OFFLINE position.
- b. If the KY-100 is not on, turn PRESET switch to MAN position.
- c. Connect a fill device to the KY-100 fill connector.
- d. Push the ↑ (up arrow) or → (right arrow) button until **KEY OPS** is displayed.
- e. Push the INIT button. **LOAD KEY** will be displayed.
- f. Push the INIT button. **LOAD N** with a flashing N will be displayed. The flashing N indicates the currently selected key location.
- g. Press the ↑ (up arrow) or → (right arrow) button until the required location (1, 2, 3, 4, 5, 6, or U) is displayed.
- h. Press the INIT button. The entire **LOAD N** message will now be flashing.
- i. Turn on fill device and select key to be loaded.

**NOTE**

DO NOT press the INITIATE pushbutton (or pull tape through tape reader) on fill device.

j. Press the INIT button. (When using a KOI-18 pull tape through tape reader at a steady rate after the terminal INIT button is pressed). Upon completion of a successful load, a pass tone will be heard and the display will momentarily indicate **KEY N**, where N is the key location loaded.

k. The display will again show **LOAD N** with N flashing. To load additional keys, repeat steps g. through j. until all desired key locations have been loaded.

1. Turn off and disconnect the till device from the KY-100.

m. Rotate MODE switch out of OFFLINE to exit Key Load.

**3-23.11. Zeroize Procedures.**

a. Zeroize ALL keys. This procedure is active even if primary Power is removed from the KY-100. All key locations within the KY-100 will be zeroized. Once zeroized, only PT voice communications are possible until a new Traffic Encryption Key (TEK) is loaded.

(1) Pull the MODE switch and rotate it to the Z ALL position. All keys stored in locations 1-6 and U will be erased.

(2) If the KY-100 is on when this procedure is performed, **ZEROED** will be displayed, and a tone will be heard.

(3) If the KY-100 power is on when the MODE switch is rotated out of the Z ALL position, **PUSH INIT** will be displayed. Follow the COLD START procedures.

b. Zeroize SPECIFIC key locations.

(1) Place the KY-100 MODE switch to the OFFLINE position.

(2) If the KY-100 is not on, turn PRESET switch to MAN position.

(3) Push the ↑ (up arrow) or → (right arrow) button until **KEY OPS** is displayed.

(4) Push the INIT button. **LOAD KEY** will be displayed.

(5) Push the ↑ (up arrow) or → (right arrow) button until **ZERO** is displayed.

(6) Push the INIT button. **ZERO N** with a flashing N will be displayed. The flashing N indicates the currently selected key location to be zeroized.

(7) Press the ↑ (up arrow) or → (right arrow) button until the required location (1, 2, 3, 4, 5, 6, or U) is displayed.

(8) Press the INIT button. The entire **ZERO N** message will now be flashing.

(9) Press the INIT button. The display will go blank while the key zeroize process is being performed. Upon completion of a successful key zeroizing, a pass tone will be heard and the display will briefly indicate **ZEROED N**, where N is the key location.

(10) To zeroize additional keys, wait until the display indicates **ZERO N** (with N flashing), then repeat steps 7 through 9.

(11) Rotate MODE switch out of OFFLINE to exit Key Load.

**3-23.12. Online Mode Selection Menu.** This procedure is used to modify the Online MODE configuration.

a. Place the KY-100 MODE switch to the CT position.

b. Rotate the KY-100 PRESET switch to the MAN position. If the PRESET switch is in position 1, 2, 3, 4, 5, or 6, the MODE selections cannot be modified. Refer to the section on changing PRESET settings to modify the PRESET configuration.

c. Press the INIT button. The WB (Wide Band) or NB (Narrow Band) (which ever mode is active) enunciator will begin flashing.

#### NOTE

The KY-100 will be operated in Narrow Band mode only with the ARC-220 Radio Set.

d. Press the ↑ (up arrow) button until the desired enunciator (WB or NB) is flashing.

e. Press the → (right arrow) button. The Mode field will be flashing.

f. Press the ↑ (up arrow) button until the desired Mode setting (CT or PT) is flashing.

g. Press the → (right arrow) button. The Modem field will be flashing.

h. Press the → (up arrow) button until the desired Modem setting (HF, LOS, or bd) is flashing.

i. Press the → (right arrow) button. The Key field will be flashing.

j. Press the ↑ (up arrow) button until the desired Key location (1, 2, 3, 4, 5, or 6) is flashing.

k. Press the → (right arrow) button. The Data Rate field will be flashing.

1. Press the ↑ (up arrow) button until the desired Data Rate (300, 600, 1.2K, or 2.4K) is flashing.

m. After all fields have been set properly: Press the INIT button to save the settings and return to Standard Operations.

#### **3-23.13. Cipher/Plain Text Level Modification.**

The following procedures are used to modify the Receive Cipher Text Level Receive Plain Text Level, and CT/PT or Cipher Text Only menus.

a. Place the KY-100 MODE switch to the CT position.

b. Rotate the KY-100 PRESET switch to the MAN position.

c. To modify the Receive Ciphertext Volume, go to step d, to modify the CT/PT or Ciphertext Only setting, go to step i, and to modify the Receive Plaintext Volume, go to step n.

d. Push the ↑ (up arrow) or → (right arrow) button until **RXCTV N** (where N represents the current receive level) is displayed.

e. Push the INIT button. The N in RXCTV N will begin to flash.

f. Push the ↑ (up arrow) or → (right arrow) button until the desired receive level is displayed.

g. Push the INIT button. The N in RXCTV N will stop flashing.

h. Push the ↑ (up arrow) or → (right arrow) button until the Operating Mode is displayed. This completes the Receive Ciphertext Volume adjustment.

i. Push the ↑ (up arrow) or → (right arrow) button until **CT** or **CT ONLY** is displayed.

j. Push the INIT button. The CT or CT ONLY will begin to flash.

k. Push the ↑ (up arrow) or → (right arrow) button until CT (Ciphertext and Plaintext operation) or CT ONLY (Ciphertext only operation) is displayed.

1. Push the INIT button. The CT or CT ONLY will stop flashing.

m. Push the ↑ (up arrow) or → (right arrow) button until the Operating Mode is displayed. This completes the CT/PT or CT Only setting.

n. Push the ↑ (up arrow) or → (right arrow) button until **RXPTV N** (where N represents the current receive level) is displayed.

o. Push the INIT button. The N in RXPTV N will begin to flash.

p. Push the ↑ (up arrow) or → (right arrow) button until the desired receive level is displayed.

q. Push the INIT button. The N in RXPTV N will stop flashing.

r. Push the ↑ (up arrow) or → (right arrow) button until the Operating Mode is displayed. This completes the Receive Plaintext Volume adjustment.

**3-23.14. Standard Operation.** These procedures describe normal transmit/receive operation for cipher text and plaintext voice messages.

a. Rotate the KY-100 PRESET switch to MAN (for manual selection) or the desired preset position. b. For ciphertext operation: Place the MODE switch in CT. Ciphertext messages can now be transmitted or received. If the CT, CT ONLY menu is set for CT, plaintext messages can also be received. When transmitting in ciphertext, the TX and V enunciators will be lit. When receiving a ciphertext message, the RX and V enunciators will be lit. When receiving a plaintext message, the PT enunciator will be lit.

c. For plaintext operation: Place the MODE switch in PT. The CT, CT ONLY menu must be set for CT to be able to transmit or receive plaintext messages. When transmitting in plaintext, the TX enunciator will be lit. When receiving a plaintext message, the RX and PT enunciators will be lit.

**3-23.15. Troubleshooting.** Follow these procedures if the KY-100 displays a FAIL message during equipment configuration or operation.

a. Rotate the KY-100 PRESET switch to the PWR OFF position.

b. Place the MODE switch in the OFFLINE position.

c. Rotate the PRESET switch to MAN.

d. If the KY-100 does not display a FAIL message after self test: Return to normal operation.

e. If the KY-100 does display a FAIL message after self test: Rotate the PRESET to the PWR OFF position.

f. Pull the MODE switch and rotate it to the Z ALL position.

g. Follow the COLD START Procedures.

h. If the KY-100 does not display a FAIL message after self test: Return to normal operation.

i. If the KY-100 does display a FAIL message after self test: Notify maintenance.

**3-23.16. Off-Line Tests.** The off line TEST menu consist of automatic (AUTO) tests, user-selectable (USER) tests and software version (VERSION) checking procedures.

a. Preliminary.

(1) Set the KY-100 MODE control to the OFFLINE position.

(2) The display will indicate **TEST** which is the first OFFLINE menu.

(3) Press the INIT pushbutton to access the TEST submenus.

(4) Press the ↑ (up arrow) or → (right arrow) pushbutton until the desired sub-menu option (AUTO or USER) is displayed.

(5) Proceed to paragraph b, c or d as applicable.

b. Automatic (AUTO) Tests.

(1) With AUTO displayed, press the INIT pushbutton to start the automatic tests.

(2) At the conclusion of the automatic tests, the test results will be presented in the display.

(3) If the automatic tests are successful, **PASS** will be displayed and a pass tone will be heard. Next, the display will indicate **USER** which is the next sub-menu. To perform the USER tests, proceed to paragraph c. To exit, rotate the MODE control switch out of the OFF-LINE position.

(4) If a failure is detected during the automatic tests, a FAIL message will be displayed.

c. User Tests.

(1) With **USER** displayed, press the INIT pushbutton to start the user tests.



(2) **PT LOOP** will be momentarily displayed to indicate that a plaintext loopback test will be performed. Next, a **PTT** prompt is displayed.

(3) Depress and hold the PTT switch and, with a **TALK** prompt displayed, speak into the microphone. Looped back plaintext voice will be heard in the handset receiver.

(4) Release the PTT switch.

(5) **CT LOOP** will be momentarily displayed indicating that the KY-100 is in the cipher text loopback mode. Next a **PTIT** operator prompt is displayed.

(6) Press and hold the PTT switch and, with a **TALK** prompt displayed, speak into the microphone until the **TALK** prompt disappears (approximately 15 seconds).

(7) Release the PTT switch. The **LISTEN** prompt is displayed. Listen to synthesized speech at the receiver. Upon completion of the speech loopback, observe that **PANEL** is displayed.

**NOTE**

To exit and skip remaining USER tests, press the ↑ (up arrow) or → (right arrow) pushbutton switch within 5 seconds.

(8) Within 5 seconds after completion of the CT loopback test, observe that all liquid crystal display (LCD) segments are on. At completion of the display test a momentary **INIT** operator prompt is displayed indicating the start of front panel switch test.

**NOTE**

Failure to perform any of the panel pushbutton and switch prompts within 30 seconds will result in a fail tone and the display will indicate **FAIL FP** (Front Panel).

(9) Press the INIT pushbutton switch. A → (right arrow) is displayed.

(10) Press the → (right arrow) pushbutton switch. An ↑ (up arrow) is displayed.

(11) Press the ↑ (up arrow) pushbutton switch. **PT** is displayed.

(12) Set the MODE control switch to PT. **CT** is displayed.

(13) Set the MODE control switch to CT. **RK** is displayed.

(14) Set the MODE control switch to RK. **OFL** is displayed.

(15) Set the MODE control switch to OFFLINE. **Eb** is displayed.

(16) Set the MODE control switch to EB. **PRESET** will be momentarily displayed, followed by **MAN**.

(17) Set the PRESET switch to MAN. A '1' is displayed.

(18) Set the PRESET switch to 1. A '2' is displayed.

(19) Set the PRESET switch to 2. A '3' is displayed.

(20) Set the PRESET switch to 3. A '4' is displayed.

(21) Set the PRESET switch to 4. A '5' is displayed.

(22) Set the PRESET switch to 5. A '6' is displayed.

(23) Set the PRESET switch to 6. A pass tone will be heard indicating that the panel test was completed successfully.

(24) Upon completion of the USER tests, the menu will sequence to **VERSION**. Exit the user test mode at this time by rotating the MODE control switch out of the **OFFLINE** position.

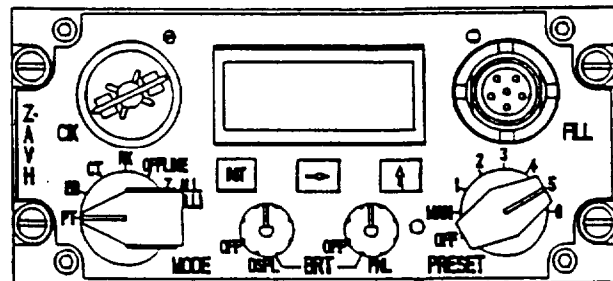


Figure 3-8.1. Remote Control Unit TSEC/KY-100 (Z-AVH)

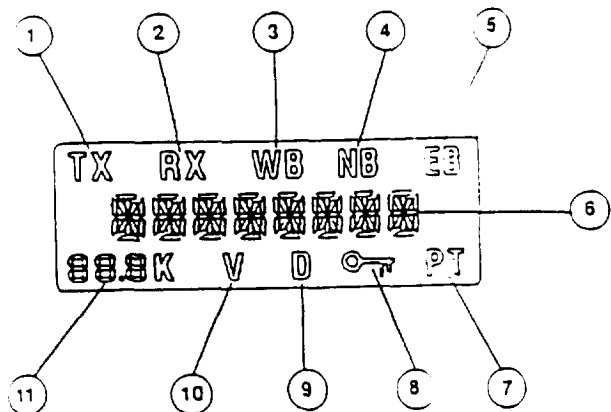


Figure 3-8.2. LCD Display TSEC/KY-100 (Z-AVH)

SECTION III NAVIGATION EQUIPMENT

3-24. VHF NAVIGATION AND INSTRUMENT LANDING SYSTEM (AN/ARN-123).

The VHF navigation and instrument landing system (AN/ARN-123) is an integrated navigation receiver consisting of a 160-channel VOR receiver, a 48-channel localizer receiver, a 40-channel glideslope receiver, and a marker beacon receiver. Each receiver operates independently. The system consists of a control panel on the console, a receiver on the avionics shelf, and three antennas on the fuselage. The set includes VOR and marker beacon self-test capability.

a. VOR/Localizer Receiver: The VOR/localizer receiver processes signals in the frequency range 108.00 through 117.95 MHz. The VOR/localizer information is presented on the course deviation bar of the HSI on the pilot's and copilot's instrument panels. VOR bearing information is displayed on the No. 2 pointer of the indicator. If the received signal is weak or the set malfunctions, a red NAV flag will appear on the indicator. The VOR/localizer antenna is on the bottom of the helicopter at sta. 79.

b. Glideslope Receiver The glideslope receiver section of the AN/ARN-123 processes signals in the frequency range of 329.15 through 335.00 MHz. Glideslope information is displayed on the HSI. The set will also cause a red GS warning flag to appear on the indicator when the received signal is unreliable or the glideslope receiver malfunctions. The glideslope antenna is on the forward pylon above the windshield.

c. Marker Beacon Receiver. The marker beacon receiver is a fixed-frequency receiver (75 MHz) which receives signals from a ground marker beacon transmitter to determine helicopter position. The audio output of the marker beacon receiver is applied through the interphone system to the headsets as a direct input (no interphone control box switch setting necessary). Three marker beacon lights are on each HSI MODE SELECT panel. The lights are labeled MKR BCN and indicate marker beacon passage. Also, specific tones will be heard over the interphone while flying over each beacon. Table 3-2 presents the indication as each beacon is passed. The lights are tested by momentarily pressing any one of three lights. The marker beacon antenna is under the fuselage forward of the forward cargo hook. Power to operate the set is from the DC essential bus through the NAV VOR circuit breaker on the No. 1 PDP. Power is supplied by the 26-volt AC instrument bus through the NAV VOR circuit breaker on No. 1 PDP.

Table 3-2. Marker Beacon Indicator

BEACON	LIGHT COLOR	TONE (HERTZ)
Outer (O)	Blue/Green	400
Middle (M)	Blue/Green	1300
Inner (I)	Blue/Green	3000

3-24.1 OPERATIONAL CHECK/SELF-TEST

NOTE

This test requires an external VOR RF signal generated by a ground station, or ramp test set.

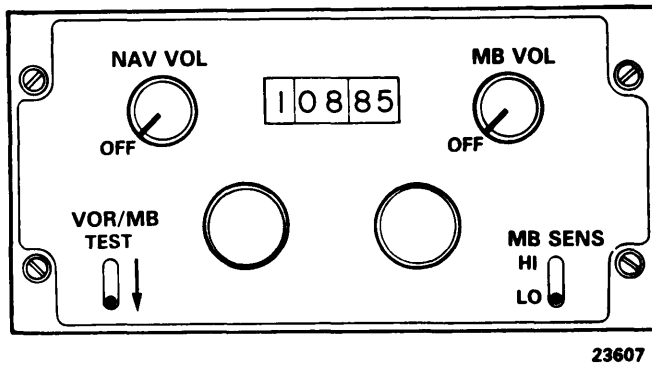
- a. Set the course indicator OBS control for a 315 degrees indication under the course index
- b. Move the control unit VOR/MB switch to the test position (down).
- c. The CDI deviation needle should indicate center  $\pm 2$  dots.
- d. The VOR/LOC flag should be burred
- e. The RMI should point to the 315 degrees radial ( $\pm 5$  degrees).
- f. The marker beacon lamp(s) should illuminate.

3-25. Controls and Function, VHF Navigation and Instrument Landing System Set. (fig. 3-9)

CONTROLS/INDICATOR	FUNCTION
NAV VOL	Provides power to set when turned from OFF Turning knob clockwise Increases volume.
VOR/MB TEST	Switch spring-loaded from TEST position. At TEST, the MKR BCN lights illuminate.
Megahertz Select Knob	Left frequency select knob sets second and third digits of frequency in one megahertz steps.
Kilohertz Select Knob	Selects last two digits of frequency in 50-kilohertz increments.
MB VOL	Adjusts audio output level of marker beacon receiver Provides power to the marker beacon when turned from OFF.
MB SENS	Labeled HI and LO LO sensitivity is used for positive identification of marker beacon passage HI is used for station passage identification at the outer marker or enroute.
Marker Beacon Indicator Lights	Three lights marked O.M. and I on both HSI MODE SELECT panels. Lights illuminate when passing over beacons.

3-26. Normal Operation - VHF Navigation and Instrument Landing System. The following paragraphs provide navigation radio set operating procedures.

- a. Starting.
  - (1) Interphone AUX switch - ON.



**Figure 3-9. VHF Navigation and Instrument Landing System Control (ANIARN-123)**

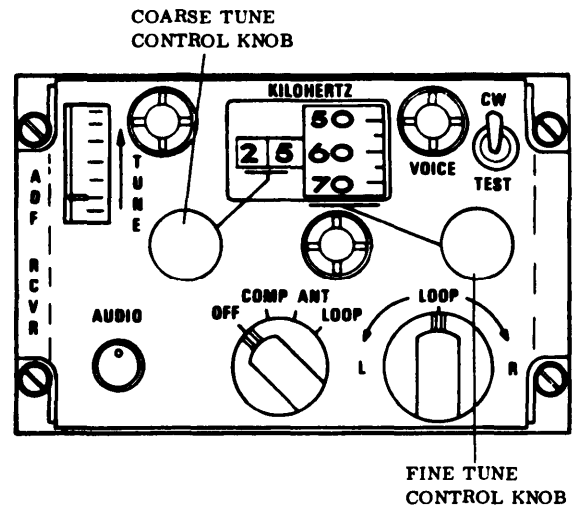
- (2) NAV VOL switch – ON.
- b. VOR/Localizer/ILS Operation.
  - (1) Megahertz and kilohertz selector – Set frequency of facility.
  - (2) VOR SEL switch on HSI MODE SELECT panel – Press. Check SEL light lit.
  - (3) VOR ADF switch on HSI MODE SELECT panel – Press, if VOR segment is not lit.
  - (4) Volume control – Adjust. Identify facility.
  - (5) HSI's – Check for correct indications.
- c. Marker Beacon Operation.
  - (1) MB VOL switch – ON.
  - (2) MB SENS – HI for enroute. LO for approach.
  - (3) MKR BKN lamps on HSI MODE SELECT panels – Check lit at corresponding station passage.
- d. Stopping – NAV VOL and MB VOL switches - OFF.

**3-27. Direction Finder Set (AN/ARN-89).**

Direction finder set (AN/ARN-89) is an airborne automatic direction finder (ADF) operating within the frequency range of 100 to 3,000 kHz. The equipment provides visual and aural facilities for ADF homing and position fixing. It is used as a navigational radio aid to continuously and visually indicate the magnetic bearing of a radio station while providing aural reception. The bearing of a radio station is displayed on the No. 2 bearing pointer on the HSI. Power to operate the direction-finder set is supplied by the No. 1 DC bus and the AC instrument bus through the NAV ADF circuit breakers on No. 1 PDP.

**3-28. Controls and Function, Direction Finder Set (AN/ARN-89). (fig. 3-10)**

CONTROLS/INDICATOR	FUNCTION
Mode Switch OFF	OFF position deenergizes the direction finder set.
COMP	COMP position selects automatic direction finding.
ANT	ANT position permits reception for radio navigation or as a broadcast receiver.
LOOP	LOOP position, used in conjunction with LOOP switch, permits aural null homing and manual direction finding.
AUDIO Control	Adjusts audio level in COMP position. Used as RF gain control in LOOP or ANT position.
LOOP Switch	When function switch is set to LOOP, LOOP switch enables manual rotation of ADF loop antenna and bearing indicator pointer left or right for manual direction finding, or when homing to a radio station. Returning LOOP switch to center position stops rotation of bearing indicator pointer at any desired position.



**Figure 3-10. Direction Finder Control**

CONTROLS/ INDICATOR	FUNCTION
Coarse Tune Control	Tunes receiver in 100 kHz steps as indicated by first two digits of KILOHERTZ indicator.
Fine Tune Control	Provides selection of 10 kHz digits (continuous tuning) as indicated by last two digits of KILOHERTZ indicator.
KILOHERTZ Indicator	Displays operating frequency to which receiver is tuned.
TUNE Meter	Provides indication of relative signal strength while tuning receiver to specific radio signal.
CW-VOICE-TEST Switch	Three position toggle switch. Spring loaded from TEST.
CW	Enables the beat frequency oscillator (BFO) to permit tuning to continuous wave stations.
VOICE	Enables the set to operate as an AM receiver.
TEST	Rotates the bearing indicator approximately 180° to check operation of the set. The TEST switch functions when the function switch is at COMP only.

**3-29. Normal Operation - Direction Finder Set.**

The following paragraphs discuss ADF set operation.

- a. Starting.
  - (1) Interphone control panel – Receivers NAV switch – ON.
  - (2) Mode switch – COMP.
  - (3) CW-VOICE-TEST – CW or VOICE.
  - (4) Tune controls – Set frequency. Tune for maximum signal strength on the tuning meter.
  - (5) AUDIO control – Adjust.
- b. ADF Operation.
  - (1) VOR ADF switch on HSI MODE SELECT panel - Press, if ADF segment is not lit,
  - (2) Check for the correct bearing indication, on HSI No. 2 bearing pointer.
- c. Radio Receiver Operation.
  - (1) Function switch – ANT.
  - (2) Tune control – Set frequency; then tune for maximum signal strength on the tuning meter.

d. Aural Null.

- (1) CW-VOICE-TEST switch – CW.
- (2) Function switch – LOOP.
- (3) LOOP switch – Rotate for audio and tune indicator null. Release switch. Observe bearing to station on indicators. Two null positions, 180° apart, may be obtained.

**3-30. Gyromagnetic Compass Set (AN/ASN-43).**

The gyromagnetic compass set (fig. 3-11) is a direction sensing system which provides a visual indication of the heading of the helicopter with respect to the earth's magnetic field or referenced to a free directional gyro. Heading information is displayed on both HSIS. The display is used in navigation to maintain flight path direction. Also, any heading selected with the heading bug on either HSI can be automatically maintained by the AFCS. Power to operate the system is supplied by the No. 1 AC bus and the AC instrument bus through the NAV CMPS circuit breakers on the No. 1 PDP.

**3-31. Controls and Function, Gyromagnetic Compass Set (AN/ASN-43).** (fig. 3-11 and 3-12)

CONTROLS/ INDICATOR	FUNCTION
LATITUDE Switch	Two-position switch on the directional gyro located on the avionics shelf. This switch is used to correct for gyro precession for the hemisphere of operation: N for northern hemisphere and S for southern hemisphere.
LATITUDE Control Switch	Rotary control on directional gyro labeled 0 to 90. It is used to set the local latitude into the directional gyro for free gyro operation.
SLAVED-FREE Switch	On compass control panel. When switch is at SLAVED, the compass cards on both HSIs are slaved to the output of the remote compass and stabilized by the directional gyro. At FREE, the cards are referenced to the directional gyro only and act as turn indicators. FREE is used primarily in polar regions where magnetic indications may be unreliable.

CONTROLS/ INDICATOR	FUNCTION
Annunciator	Indicates misalignment between compass cards and gyro-compass when pointer is not centered.
PUSH TO SET synchro- nizing knob	Rotated in (-) or (+) direction as indicated by annunciator pointer to align compass cards with gyro-compass.
HDG Flag	A red flag on both HSIs indicates failure of the gyromagnetic compass system when displayed.

**3-32. Operating Procedures - Gyromagnetic Compass Set.** (fig. 3-11)

a. *Slaved Gyro Operation.* With compass slaving switch at SLAVED, the system operates in the slaved mode and the directional gyro precesses to align the compass cards on the HSIs with the magnetic heading of the helicopter. During the first 2 minutes after power is applied, the system operates in a fast slave mode while the gyro attains its speed. After this initial alignment period is complete, the gyromagnetic compass will return to the normal slaved mode. During this mode of operation, the compass cards will remain aligned with the magnetic heading of the helicopter. The annunciator pointer will occasionally point to a dot (a) or a plus sign (+) indicating that corrections are automatically being made.

b. *Free Directional Gyro Operation.* If the compass slaving switch is at FREE, the system operates in the free directional mode. In this mode, the compass cards can be set to any heading by pressing the PUSH TO SET knob and turning it until the cards reach the selected setting. Normally, the free directional gyro mode is employed only in polar regions of the earth where magnetic references are unreliable. However, it can be useful if the slaving system malfunctions. For proper operation, the latitude controls on the directional gyro (fig. 3-12) must be set to the local latitude.

**NOTE**

If synchronizing becomes necessary in flight with the AFCS on, position the SWIVEL switch to UNLOCK. After synchronization is complete, position the SWIVEL switch to LOCK. This prevents unwanted yaw axis inputs.

c. *Manual Synchronization.* If power has been applied to the system with the compass slaving switch at FREE or if the system has been operated in the free directional gyro mode for a period of time, the compass cards will not be aligned with the magnetic heading of the helicopter. The system can be reset to the correct magnetic heading by pushing and turning the PUSH TO SET knob in the direction of the symbol indicated by the annunciator pointer until the pointer is centered. If the slaving switch is then set to SLAVED, the compass cards will maintain correct magnetic heading.

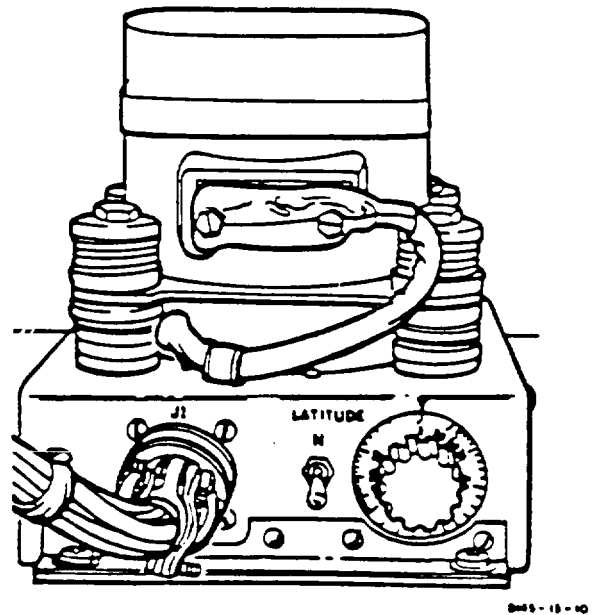


Figure 3-12. Directional Gyro (CN-998/ASN-43)

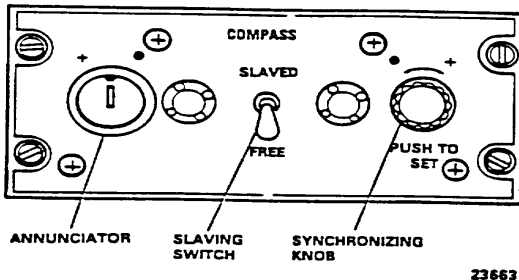


Figure 3-11. Gyromagnetic Compass Set Control Panel

3-33. Doppler Navigation Set (AN/ASN-128).

**NOTE**

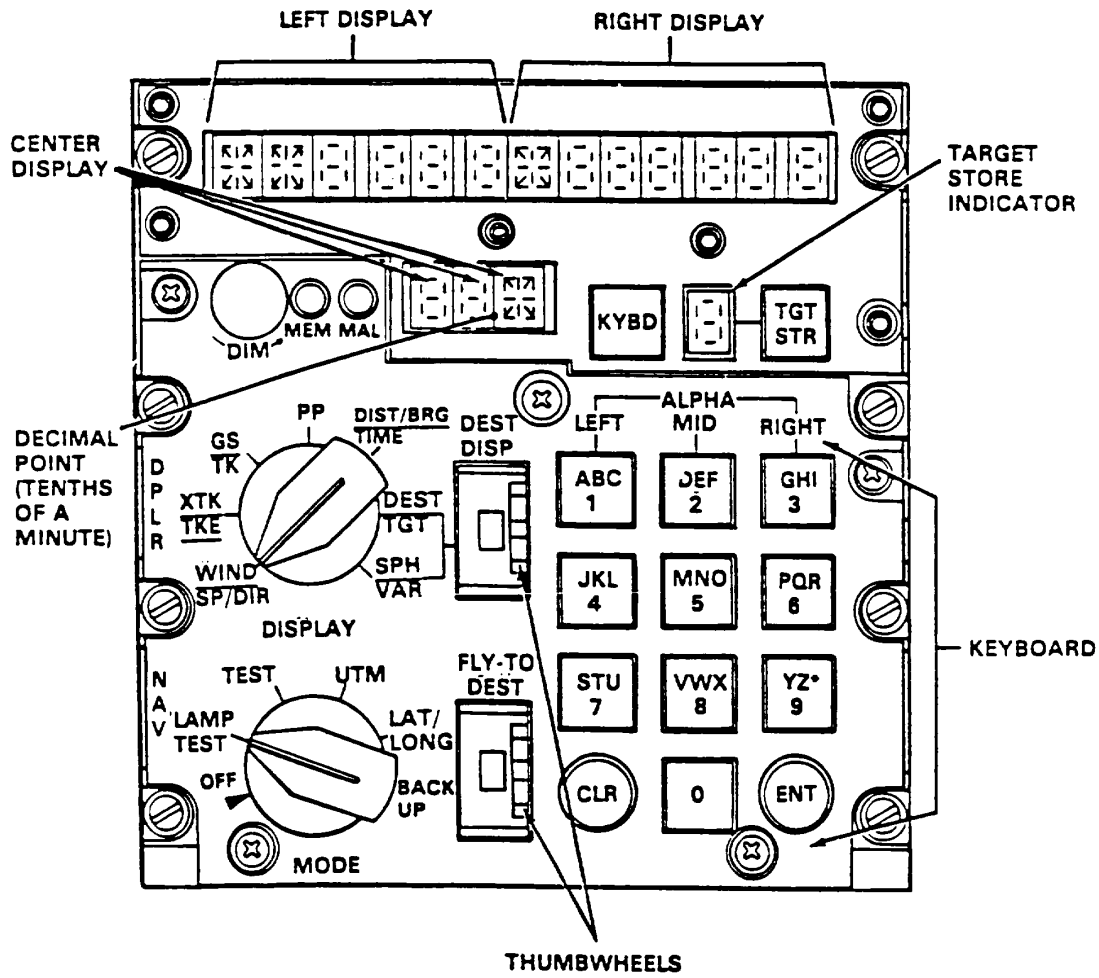
When the Airborne Navigation Set ANIASN-149 (Global Positioning System, GPS) is installed, the Doppler Navigation Set AN/ASN-128 is controlled by the GPS CDU. For a description of the Airborne Navigation Set and Doppler Navigation Set, refer to paragraph 3-65.

a. The doppler navigation set (fig 3-13) is a self-contained navigation system that does not require any ground-based aids. The system provides worldwide

navigation, with position readout available in both universal transverse mercator (grid) (UTM) and latitude and longitude (lat/long). Navigation and steering is done using lat/long coordinates, and bilateral UTM-lat/long conversion routine is provided for UTM operation.

b. The system in conjunction with heading data from the gyro compass, and pitch and roll data from the copilot's attitude gyro, provides velocity, position, and steering information from ground level to 10, 000 feet.

c. The computer-display unit (CDU) is on the canted console, between the pilot and copilot positions. Course



**NOTE:**  
DISPLAYS SHOWN WITH  
MODE SWITCH AT LAMP TEST.

18540

Figure 3-13. Doppler Navigation Set Control (AN/ASN-128)

deviation, bearing, distance to destination, and NAV GO/NO GO are also presented on the HSI. Built in test equipment (BITE) continuously monitors system operation. If a failure occurs, a malfunction indicator lamp will light and coded data, indicating the failed component, will be displayed on the CDU when the MODE switch is set to TEST. Power to operate the set is supplied by the No. 2 DC bus through the NAV DOPPLER circuit breaker on the No. 2 PDP, and the No. 1 AC instrument bus through the NAV DOPPLER circuit breaker on the No. 1 PDP.

**3-34. Controls and Function - Doppler Navigation Set.** (fig. 3-13 and table 3-3)

CONTROLS/ INDICATOR	FUNCTION
MODE Selector	Selects doppler navigation mode of operation as follows:
OFF	Turns set off. Pull knob out to move from, or to this position.
LAMP TEST	Checks operation of all lamps and lamp segments.
TEST	Initiates (BIT) for set. System reverts to backup navigation operation during this mode.
UTM	Selects universal transverse mercator coordinate system for display and insertion of information.
LAT/LONG	Select latitude/longitude coordinate system for display and insertion of in-
BACKUP	Places set in remembered velocity mode of operation.
DISPLAY	SelectorSelects navigation data for display as follows:
WIND SP/DIR	Used only with BACKUP mode.
(Left Display)	Windspeed kilometer(s) per hour.
(Right Display)	Direction (degrees) relative to true north.
XTK/TKE	
(Left Display)	Distance crosstrack error (XTK) in km and tenths of a km left or right of helicopter. Track error will also be displayed by the course deviation indicator (CDI) on the HSI when DOP

CONTROLS/ INDICATOR	FUNCTION
(Right Display)	SEL on the HSI MODE SELECT panel is pressed. Track angle error (TKE) in degrees and right or left of present helicopter heading.
GS/TK (Left Display)	Ground speed (GS) in km/hr.
(Right Display)	Track angle in degrees relative to true north.
PP with mode switch set to UTM (Center Display) (Left Display)	Present position UTM zone. Present position UTM square designator and casting in km to nearest 10 meters.
(Right Display)	Present position UTM northing in km to nearest 10 meters.
PP with MODE switch set to LAT/LONG (Left Display)	Present latitude position in degrees, minutes, and tenths of minutes.
(Right Display)	Present longitude position in degrees, minutes, and tenths of minutes.
DIST/BRG/TIME	
(Center Display)	Time to the destination set on FLY-TO DEST thumbwheel in minutes and tenths of minutes.
(Left Display)	Distance to the destination set on FLY-TO DEST thumbwheel in km and tenths of a km.
(Right Display)	Bearing to the destination set on FLY-TO DEST thumbwheel in degrees. Bearing is also indicated by the No. 1 bearing pointer on both HSIs.
DEST/TGT	
(Center Display)	UTM zone of destination set on DEST DISP thumbwheel.



CONTROLS/ INDICATOR	FUNCTION
(Left Display)	UTM square designator and casting or latitude (N 84° to S 80° approx) of destination set on DEST DISP thumbwheel.
SPH/VAR (Left Display)	Spheroid code of destination set on DEST DISP thumbwheel.
(Right Display)	Magnetic variation (in degrees and tenths of degrees) of destination set on DEST DISP thumbwheel.
MAL Indicator Lamp	Lights when set malfunctions. In case of an intermittent malfunction, system may operate correctly, but must be cycled to OFF and then to on to put MAL light off.
MEM Indicator Lamp	Lights when radar portion of set is not tracking. May occur over smooth water.
DIM Control	Controls light intensity of display characters.
Left, Right, and Center Display Lamp	Alphanumeric and numeric characters that display data as determined by setting of DISPLAY switch, mode switch, and keyboard.
Target Storage Indicator	Displays destination number (memory location) in which present position will be stored when TGT STR pushbutton is pressed.
TGT STR Pushbutton	Stores present position data when pressed.
KYBD Pushbutton	Used in conjunction with keyboard to allow data entry. KYBD pushbutton is always lighted when system is on.
DEST DISP Thumbwheel Switch	Destination display thumbwheel switch is used along with DEST/TGT and SPH/VAR positions of DISPLAY switch to select destination whose coordinates or magnetic variation to be displayed or entered. Destinations are 0 through 9, P

CONTROLS/ INDICATOR	FUNCTION
Keyboard	(present position) and Hr (home). Used to enter data into system. Keys set up data on display. All resulting actions are initiated upon release of the key.
FLY-TO-DEST Thumbwheel Switch	Selects destination to which steering information is desired. Destinations are 0 through 9, P (present position) and H (home).
ENT Key	Enters data set upon keyboard into memory when pressed.
CLR Key	Clears last entered character when pressed once. Clears entire display panel under keyboard control when pressed twice.

**3-35. Display and Keyboard Operation.**

In LAT/LONG coordinates, the two fields of control are the left and right displays. In UTM coordinates, the first field of control is the center display and the second field is the combination of the left and right displays. When pressing the KYBD pushbutton, one or other of the fields described above is under control. If it is not desired to change the information in the field under control, the pilot can advance to the next field of the display panel by pressing the KYBD pushbutton again.

**3-36. Data Entry.**

To enter a number, press the corresponding key. To enter a letter, first press the key corresponding to the desired letter. Then press a key in the LEFT, MID, or RIGHT column corresponding to the position of the letter on the pushbutton.

Example: To enter an L, first press L, then either 3, 6, or 9 in the RIGHT column. The computer program is designed to reject unacceptable data (for example, a UTM area of WI does not exist, and will be rejected). If the operator attempts to insert unacceptable data, the display will be blank after ENT is pressed.

**3-37. Starting Procedure.**

a. MODE selector – LAMP TEST. All lights and lamp segments should be lit.

(1) Left, right, center and target storage indicator – Lit (fig. 3-13). All other lights should be on,

(2) Turn DIM control fully clockwise, then fully counterclockwise, and return to full clockwise; all segments of the display should alternately glow brightly, go off, and then glow brightly.

**Table 3-3. Computer-Display Unit Data displays**

SWITCH POSITION	CENTER DISPLAY		LEFT DISPLAY		RIGHT DISPLAY	
	DATA	RANGE	DATA	RANGE	DATA	RANGE
WIND SP/DIR			Windspeed	999 km/h	Wind Direction	359°
XTK/TKE			Crosstrack Dis- tance Error	L/R 999.9 km	Track Angle Error	R/L 180°
GS/TK			Groundspeed	999 km/h	Track	359°
PP UTM	UTM Zone	Note 2	Area/Easting	WV9999	Northing	9999
LAT/LONG			Latitude	N84°00.0" S 80°00.0"	Longitude	E/W 180°00.0"
DIST/BRG/TIME	Time	99.9 Min.	Distance to Go	999.9 km	Bearing	359°
DEST/TGT UTM	UTM Zone	Note 2	Area/Easting	WV9999 Note 3	Northing	9999
LAT/LONG			Latitude	N 84°00.0" S 80°00.0"	Longitude	E/W 180°00.0"
SPH/VAR			Spheroid	Note 1	Variation Note 4	E/w 180°

**NOTES**

1. See table 3-4 for spheroid data codes and covered areas.
2. Numeric 01-60.  
Alpha: C-X, except I and O.
3. Typical 100 km Designaton  
Column Designation A-Z, except I and O.  
Row Designator A-V, except I and O.
4. Variation displayed is for destination indicated by DEST DISP thumbwheel.

b. MODE selector - TEST. After about 15 seconds, left display should display GO. Ignore the random display of alpha and numeric characters which occurs during the first 15 seconds. Also ignore test velocity and angle data displayed after the display has frozen. After about 15 seconds, one of the following five displays will be observed in the first two character positions in the left display.

**NOTE**

If the MAL lamp lights during any mode of operation except LAMP TEST, the computer-display unit MODE switch should be set to OFF, and then to TEST, to verify the failure. If the MAL lamp remains on at TEST, notify maintenance.

If the TEST mode display is MN or NG, the MODE switch should be recycled through OFF to verify that the failure is not a momentary one. If the TEST mode display is MN, the data entry may be made in the UTM or LAT/LONG mode, but any navigation must be carried on with the system in the BACKUP mode.

DISPLAY		REMARKS
LEFT	RIGHT	
GO	Display blanks	System is operating satisfactorily.
BU	C, R, S, or H followed by a numeric code	A failure has occurred and the system has automatically switched to a BACKUP mode of operation using last remembered velocities for navigation. The operator can, as an option, enter his best estimate of ground speed and track angle.
MN	C, R, S, or H followed by a numeric code	A failure has occurred and the BACKUP mode used for manual navigation (MN) is the only means of valid navigation. The operator may use the computer as a dead reckoning device by entering ground speed and track data.

DISPLAY		REMARKS
LEFT	RIGHT	
		The operator should update present position as soon as possible, because it is possible significant navigation errors may have accumulated.
NG	C, R, S, or H followed by a numeric code	A failure has occurred in the system and the operator should not use the system.
EN		The 9V battery has failed. The system will still operate but all stored data will be lost when set is turned off. Data must be reentered.
Random display	Random display	A failure occurred and the operator should not use the system.

**3-38. Entering Data.**

This initial data is inserted before navigating with the doppler.

- a. Spheroid of operation, when using UTM coordinates.
- b. UTM or LAT/LONG coordinates of present position.
- c. Magnetic Variation (MAG VAR) of present position.
- d. Coordinates of desired destination - 0 through 5 and H: (6 through 9 are normally used for target store locations; but may also be used for destinations.) It is not necessary to enter all destinations in the same coordinate system.

**NOTE**

It is not necessary to enter destinations unless steering information is required, unless it is desired to update present position by overflying a destination, or unless a present position MAG VAR computation is desired. If a present position MAG VAR running update is desired, destination MAG VAR must be entered. The operator may enter one or more destination variations to effect the variation update; it is not necessary for all destinations to have associated MAG VAR entered.

- e. Variations of destinations.

**3-39. Entering Spheroid and/or Variation.**

- a. MODE selector - UTM, LAT/LONG or BACKUP.

- b. DISPLAY selector – SPH-VAR.
- c. DEST DISP thumbwheel – P, numeral, or H as desired.
- d. KYBD pushbutton – Press. Observe display freezes and TGT STR indicator blanks. Press KYBD pushbutton again and observe left display blanks. If no spheroid data is to be entered, KYBD pushbutton - Press again, go to step g.
- e. Spheroid data (table 3-4) – Entry. (Example: INO). Press keys 3, 3, 5, 5 and 0. Left display should indicate INO.
- f. ENT key – Press if no variation data are to be entered.
- g. KYBD pushbutton – Press, if variation data is to be entered, and note right display blanks.
- h. Variation data – Enter. (Example: E001.2, press keyboard keys 2, 2, 0, 0, 1 and 2. Press ENT key. the entire display will blank and TGT STR number will reappear, display should indicate INO E001.2.)

**NOTE**

If operation is to occur in a region with relatively constant variation, the operator enters variation only for present position, and the computer will use this value throughout the flight.

**Table 3-4. Spheroid Data Codes**

SPHEROID	CODE	AREA COVERED
CLARKE 1866	CL6	United States north through North Pole
CLARKE 1880	CLφ	Africa west through Algeria
INTERNATIONAL	IN φ	All of Europe, Saudi Arabia, Greenland, South America, Indian Ocean, Pacific Ocean, and Atlantic Ocean
BESSEL	BE φ	Indonesia, Manchuria, to Eastern Russia
EVEREST	EV φ	Mt. Everest, India, and Pakistan
AUSTRALIAN NATIONAL	AU φ	Australia

**3-40. Entering Present Position or Destination in UTM.**

The variation of a destination must be entered after the associated destination coordinates are entered, since each time a destination is entered its associated variation is deleted. The order of entry for present position is irrelevant.

- a. MODE SELECTOR – UTM.
- b. DISPLAY selector – DEST-TGT.
- c. DEST DISP thumbwheel – P, numeral, or H as desired.
- d. Present position and destination – Enter. (Example: Entry of zone 31T, area CF, casting 0958 and northing 3849).

(1) KYBD pushbutton – Press. Observe that display freeze and TGT STR indicator blanks.

(2) KYBD pushbutton – Press. Observe that center display blanks.

(3) Key 3, 1, 7, and 8 – Press.

(4) KYBD button – Press. Observe left and right displays blank.

(5) Key 1, 3, 2, 3, 0, 9, 5, 8, 3, 8, 4, 9 – Press.

(6) ENT key – Press. Left, right and center displays will momentarily blank and then display CF 0958, 3849, 31T, respectively. TGT STR number will appear.

### 3-41. Entering Present Position or Destination in LAT/LONG.

The variation of a destination must be entered after the associated destination coordinates are entered, since each time a destination is entered its associated variation is deleted. The order of entry for present position is irrelevant.

a. MODE selector – LAT/LONG.

b. DISPLAY selector – DEST-TGT.

c. DEST DISP thumbwheel – P, numeral, or H as desired.

d. Present position or destination – Enter. (Example: Entry of N41° 10.1 minutes and E035° 50.2 minutes.)

(1) KYBD pushbutton – Press. Observe that display freezes and TGT STR indicator blanks.

(2) KYBD pushbutton – Press. Observe that left display blanks.

(3) Key 5, 5, 4.1, 1, 0, and 1 – Press.

(4) KYBD pushbutton - Press. Observe right display blank.

(5) Key 2, 2, 0, 3, 5, 5, 0, and 2- Press.

(6) ENT key – Press. Left, right, and center displays will momentarily blank and TGT STR number will reappear. Displays should indicate N41° 10.1 E 035° 50.2.

### 3-42. Entering Ground Speed and Track.

a. MODE selector – BACK UP.

b. DISPLAY selector – GS-TK.

c. Ground speed and track - Enter. (Example; Enter 131 km/h and 024°. Press KYBD pushbutton, observe that left display freezes and TGT STR indicator blanks. Press KYBD pushbutton and observe that left display blanks.

d. Press keys 1, 3, and 1. Left display indicates 131. Press KYBD pushbutton, control shifts to right display, and right display blanks. Press keys 0, 2 and 4.)

e. ENT key – Press. The entire display will blank, and TGT STR number will reappear. Display should indicate 131 024°.

### 3-43. System Initialization.

a. DEST DISP thumbwheel – P.

b. Present position spheroid and/or variation (para. 3-39) – Enter.

#### NOTE

Do not press ENT key after entering initial position fix.

c. Initial fix position (para. 3-40 or 3-41) – Enter.

d. When the helicopter is sitting over or overflies the initial fix position — ENT..

e. FLY-TO DEST thumbwheel – Set to desired destination. The computer calculates a course between the destination and the helicopter position at the time the destination was selected.

### 3-44. Flight Procedures.

#### 3-45. Update of Present Position from Stored Destination.

a. FLY-TO DEST thumbwheel – Set to destination to be overflown.

b. DISPLAY selector – DIST/BRG-TIME.

c. KYBD pushbutton – Press and release when helicopter is over the destination. Display freezes upon release of the pushbutton.

#### NOTE

If a present position update is not desired, as indicated by an appropriately small value of distance to go on overflying the destination, set the DISPLAY selector to some other position; this aborts the update mode.

d. ENT key – Press if update is required.

#### 3-46. Update of Present Position from Landmark.

There are two methods for updating from a landmark. Method 1 is useful if the landmark comes up unexpectedly and the operator needs time to determine the coordinates. Method 2 is used when the landmark update is anticipated.

a. Method 1.

(1) DISPLAY selector – PP.

(2) KYBD pushbutton – Press as landmark is overflown. Present position display will freeze upon release of pushbutton.

(3) Compare landmark coordinates with those on display.

**NOTE**

If present position update is not desired, as indicated by a small difference between the displayed coordinates and the landmark coordinates, set the DISPLAY selector to some other position; this aborts the update.

(4) Landmark coordinates – Enter if difference warrants an update.

(5) ENT key – Press if update is required.

b. Method 2.

(1) DISPLAY selector – DEST/TGT.

(2) DEST DISP thumbwheel – P. Present position coordinates should be displayed.

(3) KYBD pushbutton – Press, observe that display freezes.

**NOTE**

If present position update is not desired, as indicated by a small difference between the displayed coordinates and the landmark coordinates, set the DISPLAY selector to some other position; this aborts the update.

(4) Landmark coordinates – Manually enter via keyboard.

(5) ENT key – Press when overflying landmark.

**3-47. FLY-TO-DEST Operation.**

a. When the FLY-TO-DEST thumbwheel is selected to a new position, the helicopter's present position at the time is stored in the computer. A course is then computed from the helicopter's present position, as stored, to the destination selected. If the helicopter deviates from this course, crosstrack error (XTK) is computed.

b. Range and bearing to destination, current track made good, and track angle error (TKE) correction are computed from the helicopter's present position to selected destination.

**3-48. Left-Right Steering Signals.**

Flying the shortest distance to the destination from present position:

a. FLY-TO DEST thumbwheel – Select desired destination.

**NOTE**

If the desired destination is already selected but an updated course is needed, then the FLY-TO DEST thumbwheel must be cycled to another destination and back so the computer will recalculate the new course.

b. DISPLAY selector - XTK/TKE.

c. Fly to keep the left display at L or R 000.0 and the right display to L or R 000.

**3-49. Target Store (TGT STR) Operation.**

Two methods may be used for target store operation. Method 1 is normally used when time is not available for preplanning a target store operation. Method 2 is used when time is available and it is desired to store a target in a specific DEST DISP position.

a. Method 1.

(1) TGT STR pushbutton – Press when flying over target.

(2) Present position at the time the pushbutton is released is automatically stored and the destination location is that which was displayed in the target store indicator (position 6, 7, 8 or 9) immediately before pressing the TGT STR pushbutton.

b. Method 2,

(1) MODE selector – UTM or LAT/LONG, depending on coordinate format desired.

(2) DISPLAY selector – DEST/TGT.

(3) DEST DISP thumbwheel – P.

(4) KYBD pushbutton – Press when over flying potential target, Display should freeze.

**NOTE**

Do not press ENT key while DEST DISP thumbwheel is at P.

(5) If it is desired to store the target, turn DEST DISP thumbwheel to destination location desired and press ENT key.

(6) If it is not desired to store the target, place DISPLAY selector momentarily to another position.

**3-50. Transferring Stored Target Coordinates from One Location to Another.**

The following procedure allows the operator to transfer stored target coordinates from one thumbwheel location to another. For example, it is assumed that the pilot wants to put the coordinates of stored target 7 into location of destination 2.

**NOTE**

Throughout this procedure, range, time-to-go, bearing and left/right steering data are computed and displayed for the destination selected via the FLY-TO DEST thumbwheel.

a. DISPLAY selector – DEST/TGT.

b. DEST DISP thumbwheel – 7.

c. KYBD pushbutton – Press,

d. DEST DISP thumbwheel – 2.

- e. ENT key - Press.

**3-51. Transferring Variation from One Location to Another.**

The procedure to transfer variation data to the same location where the associated stored target coordinates has been transferred is the same as in previous paragraph. Transferring Stored Target Coordinates from One Location to Another, except that the DISPLAY selector is placed at SPH/VAR.

**3-52. Dead Reckoning Navigation.**

As a BACKUP mode, dead reckoning navigation can be done using ground speed and track angle estimates provided by the operator.

- a. MODE selector - BACKUP.
- b. DISPLAY selector - GS/TK.
- c. Best estimate of ground speed and track angle - Enter via keyboard.
- d. Set MODE selector to any other position to abort this mode.

**3-53. Operation During and After Power Interruption.**

During a DC power interruption inflight, or when all helicopter power is removed, the random access memory (RAM) (stored destination and present position) data is retained by power from an 8.4 volt DC dry cell battery. This makes it unnecessary to reenter any navigational data when power returns or before each flight. If the battery does not retain the stored destination data during power interruption, the display will indicate an EN when power returns. This indicates to the pilot that previously stored data has been lost, and that present position, spheroid/variation, and destinations must be entered. The computer, upon return of power, resets present position variation to E000.0, destination and associated variations to a non-entered state, sets wind to zero and spheroid to CL6. The following data must be entered following battery failure:

- a. Spheroid.
- b. Present position variation.
- c. Present position.
- d. Each destination and its associated variation.

**3-54. Stopping Procedure.**

MODE selector - OFF.

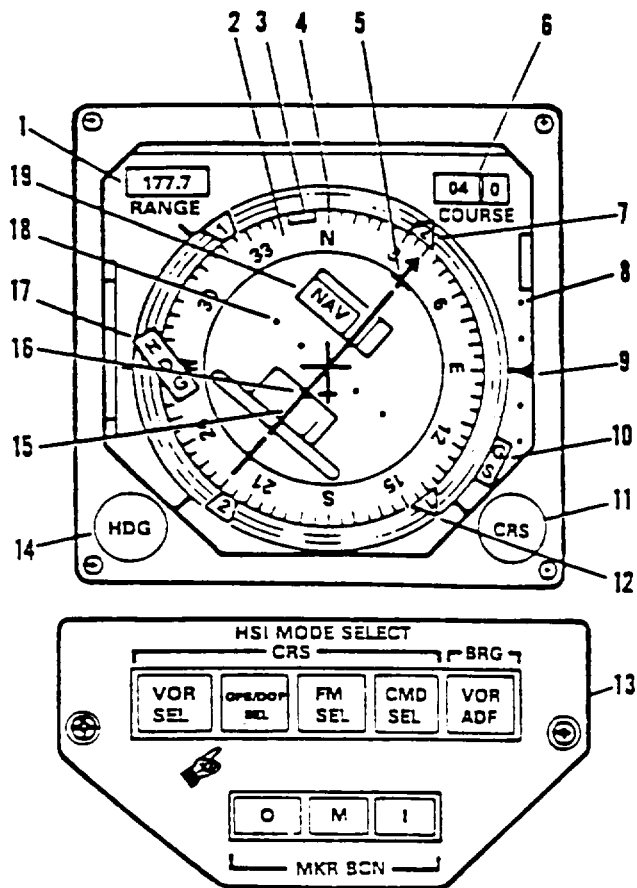
**3-55. Horizontal Situation Indicator (HSI).**

Two horizontal situation indicators (HSI) (fig. 3-14), one on each pilot's instrument panel, are installed. Each indicator can display helicopter heading, FM homing, and position relative to a selected course or bearing. Also, during an ILS approach, the indicator displays helicopter position relative to the glide slope and localizer. The automatic heading select feature of the AFCS is also controlled through the HSI. Selection of navigational equipment to be displayed on each HSI is controlled

through the HSI MODE SELECT panel on each instrument panel below each HSI. Each HSI receives electrical power from three different sources (copilots sources are in parentheses): 28 volt DC from the No. 2 (No. 1) DC bus through the NAV PLT (COPLT) HSI MODE SEL circuit breaker, 115 volt AC from the No. 2 (No. 1) AC bus through the NAV PLT (COPLT) HSI circuit breaker, and 26 volt AC from the No. 2 (No. 1) instrument bus through the NAV PLT (COPLT) HSI circuit breaker.

**3-56. Controls and Indicators - Horizontal Situation Indicators. (fig. 3-14)**

CONTROLS/ INDICATOR	FUNCTION
Compass Card	The compass card is a 360° scale that turns to display heading data obtained from the gyro magnetic compass (AN/ASN43A). The helicopter headings are read at the upper lubber line.
Bearing Pointer No.1	The pointer operates in conjunction with doppler or mixed GPS/Doppler. With Doppler Only, indicates magnetic bearing to doppler destination. With mixed GPS/Doppler, indicates magnetic bearing to GPS destination. (With GPS Only, bearing information is not available.
Bearing Pointer No.2	The pointer operates in conjunction with selected VOR or ADF receiver. The pointer is read against the compass card and indicates the magnetic bearing to the VOR or ADF station.
Course Deviation Indicator	This indicator indicates lateral deviation from a selected VOR course or GPS/Doppler computed course or heading in the case of FM homing. When the helicopter is flying to correct course, the course indicator will be aligned with the course pointer and will be centered on the fixed aircraft symbol. The two dots on either side of the indicator indicate amount of course deviation. One dot displacement is equivalent to 5 off VOR or GPS/Doppler and 11/4 degree 1 off localizer course. These displacements do not apply to FM homing.



23662

- |                                  |   |
|----------------------------------|---|
| 1. RANGE indicator (Km)          | 10. GS (glide slope) failure flag         |
| 2. Compass card                  | 11. CRS (course) select knob              |
| 3. Heading Bug                   | 12. No. 1 bearing pointer                 |
| 4. Lubber Line                   | 13. HSI MODE SELECT panel                 |
| 5. Course pointer                | 14. HDG (heading) select knob             |
| 6. COURSE indicator              | 15. Course deviation indicator            |
| 7. No. 2 bearing pointer         | 16. To-from indicator                     |
| 8. Glide slope deviation marks   | 17. HDG (heading) failure flag            |
| 9. Glide slope deviation pointer | 18. Course deviation marks                |
|                                  | 19. NAV (navigation) failure warning flag |

Figure 3-14. Horizontal Situation Indicator and Mode Select Panel

CONTROLS/ INDICATOR	FUNCTION
CRS Knob Course Indicator Course Pointer	The COURSE indicator and course pointer operate in conjunction with the course select (CRS) knob, and allow the pilot to select any VOR course. The course pointer turns with the compass card and will be aligned with the lubber line when the helicopter heading is the same as the selected course.
Range Indicator	Digital distance display in kilometers (KM) to destination set on GPS Control Display Unit (CDU) (para. 3-67) or doppler control FLYTODEST thumbwheel (para. 3-34).
HDG Knob	Heading select (HDG) knob operates in conjunction with the heading bug. It allows the pilot to select any one heading. With CMD SEL (fig. 3-14) selected on the HSI MODE SELECT panel, the AFCS (chapter 2) will turn the helicopter to and maintain the selected heading.
HDG Flag	The HDG flag is in view when the signal from the gyro magnetic compass is unreliable or power to the indicator is lost.
To-From Arrow	To from arrow indicates that the helicopter is flying to or away from a selected VOR.
NAV Flag	The NAV flag turns with the compass card. The flag will retract from view when a reliable VOR, GPS/Doppler or FM homing signal is being applied to the instrument.
Aircraft Symbol	Corresponds to longitudinal axis of the helicopter; shows helicopter position and heading relative to the selected course.
Glide Slope Pointer	Displays glide slope position relative to the helicopter or FM homing signal strength. When pointer is above center, helicopter is below glide slope, conversely when pointer is below center, helicopter is above glide slope. Increasing homing signal strength is shown by pointer rising. Decreasing signal strength is shown by pointer falling.

CONTROLS/ INDICATOR	FUNCTION
------------------------	----------

Glide Slope (GS) Warning Flag Indicates loss of or an unreliable glide slope or FM homing signal.

**357. Horizontal Situation Indicator Mode Select Panel.** (fig. 3-14) The HSI MODE SELECT panel is on each pilots instrument panel below the HSI. The panel allows the pilot to select the navigation mode to be displayed on the HSI, command AFCS heading select feature, and visually indicates marker beacon passage. The panel is divided into three sections labeled CRS, BRG, and MKR BCN.

a. The CRS (course) section consists of four pushbutton selector switches labeled VOR SEL, GPS/DOP SEL, FM I SEL, and CMDSEL. Pressing VOR SEL, GPS/DOP SEL, or FMSEL causes the output of the selected navigation set to be electrically connected to the course deviation indicator on the corresponding HSI and lights SEL legend in the switch. These switches are electrically interlocked so only one set may be selected at a time. Selecting another navigational modes, automatically disengages the mode in use, turns out the SEL legend of the mode in use, engages the selected mode, and lights the SEL legend of the selected mode. Each pilot may independently select different navigational modes for display on his HSI.

b. Pressing CMD SEL engages the AFCS heading select feature, causes the helicopter to turn to and maintain heading to which the HSI heading bug is set, and illuminates the SEL legend on the switch. Due to electrical interlocks between the two HSI control panels, both CMD SEL switches cannot be engaged at the same time. The engaged switch is indicated by the lit SEL legend. If the opposite CMD SEL switch is pressed when operating with heading select, the HDG on the AFCS panel will release and heading select will be disengaged. Control of the course deviation indicator in the VOR mode relative to bearing and course deviation to or from a VOR is assigned to the pilot who has CMD SEL engaged. If the pilot who does not have CMD SEL engaged makes an adjustment on his CRS knob, it will have no effect on the CDI relative to the course.

c. Pressing VOR/ADF pushbutton on the BRG side selects the navigational aid, the bearing of which will be indicated by the HSI No. 2 pointer. The switch is divided into two segments labeled VOR and ADF. If the VOR segment is lit, the No. 2 pointer will indicate the bearing to a VOR station to which the VHF navigation set is tuned. Pressing the switch will cause the VOR segment to go out and the No. 2 pointer will indicate the bearing to the station to which the ADF set is tuned out and light the ADF segment. The opposite action occurs if the ADF segment is lit and the switch is pressed.



d. A MKR BCN light will illuminate during marker beacon passage. The light labeled O comes on when passing through an outer marker beam. The light labeled M comes on when passing through a middle marker and finally the light labeled I comes on when passing through an inner marker. As each light illuminates, a distinctive tone identifying the beacon will be heard over the interphone (table 3-2). The lights have a press-to-test feature; pressing any one of the three lamps will cause all MKR BCN lamps to illuminate on both pilots HSI MODE SELECT panels.

**3-58. Omega Navigation System (AN/ARN-148).**

The AN/ARN-148 is a global navigation system providing the crew with actual position, distance, bearing and receiver signal strength from Omega station(s). The system is comprised of a control display unit (CDU), a navigation processor unit (NW), an airspeed processor, and an antenna coupler. The airspeed processor takes airspeed data from the helicopter pitot system for calculations. Heading information is accessed from the gyro compass system. A zero velocity signal that locks-out the system is provided from the aft landing gear proximity switch when the helicopter is on the ground. The system also features the capability of storing up to six pages of flight plans for easy reference.

**3-59. Omega Navigation Principles.**

The Omega navigation system (ONS) uses a global network of eight Omega transmitting stations to provide dead reckoning coordinates to position the helicopter relative to one or more transmitting stations. Each Omega station transmits a very low frequency (VLF) signal continuously.

The Omega VLF signals are received as phase (a measure of range to the station) and amplitude (signal strength). The ONS automatically selects an appropriate set of Omega signals, based on signal strength and geometry, and computes present position and all other navigation parameters.

**3-60. Omega Control Display Unit.**

The CDU is mounted in the center console. The CDU functions as the primary input and output of navigation information for the operator (fig. 3-15). This data defines helicopter position and navigational guidance according to a selected path across the ground.

The CDU has a dual function. The display function is handled by a two inch by three inch color cathode ray tube (CRT). The CRT displays information in seven different colors which uniquely communicates different information in different colors to the operator. The second function of the CDU allows the operator to input data into the system to define helicopter position along the desired navigational path. The data is entered through a keyboard consisting of 33 keys, Two of the keys are used to select the display brightness and one key is used to turn the system on and off. The remaining 30 keys are used for alpha-numeric data input.

The alphabet is uniquely laid out so that there are no multi-key-stroke requirements for alpha information

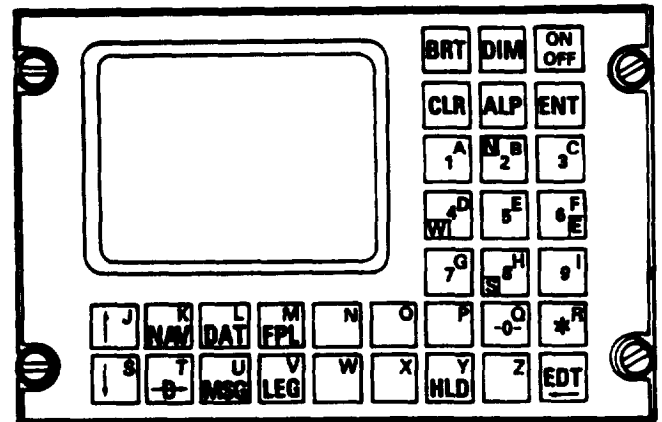
entry. The CLR key clears the data entry field, the ENT key enters data after it has been selected. The ALP key allows for mode switching between alpha and numeric data in fields where both need to be entered.

**3-61. Controls and Function, Omega Control Unit. (fig. 3-15)**

CONTROLS/ INDICATOR	FUNCTION
BRT/DIM	Controls intensity of display.
CLR	Calls up a cursor for data modification or cancels an operation.
ALP	Shifts keyboard from numeric to alpha and back to numeric.
ENT	Enters selected data into navigation processing unit memory.
NAV	Provides access to four pages of display relative to aircraft position and track leg data. Selected data pertinent to aircraft position and track leg data may be altered through these pages.
FPL	Provides display, assembly, selection, entry and modification of flight plan.
LEG	Provides display and selection from waypoint and to a waypoint. Provides for display and selection of track change mode.
⇒	Provides a means of flying from present position direct to a defined waypoint.
↓↑	Provides a means of displaying additional data when more than 8 lines of data are available.
HLD	Provides a means of manually updating position either by entering lat/long coordinates or by reference to point which has already been defined to the Omega Navigation System (ONS).

CONTROLS/INDICATOR	FUNCTION
EDT ←	During data entry mode, provides a back space function. During non-data entry mode, provides the capability to change display mode of angular data, i.e., magnetic, true, grid, heading, bearing, DTK.
*	Identifies and permits entry of waypoints as a range and bearing from a previously entered waypoint.
DAT	Provides six pages for the selection, display, and entry of data related to flight planning and Omega/VLF status.
MSG	Provides a display of system malfunctions and operator actions required. Displays condition of ONS data base and allows selection of various test modes to ensure correct system operation.
E	The "E" or "5" key provides a means of activating the erase function when the cursor is displayed at the top of the flight plan page.
I	The "I" or "9" key provides a means of reversing the flight plan when the cursor is displayed at the top of the flight plan page. The "S" or '↵' key provides a means of selecting the flight plan for use when the cursor is displayed at the top of the flight plan page.

CONTROLS/INDICATOR	FUNCTION
O	The "O" (alpha) key provides for operator deselection of an Omega or VLF station when the cursor is positioned on the same line as the station to be deselected.



Figure, 3-15. AN/ARN-148 Omega Control Display Unit

3-61.1. Doppler/GPS Navigation Set AN/ASN-128B (DGNS).

The AN/ASN-128B DGNS is an AN/ASN-128 LDNS with an embedded GPS receiver. The AN/ASN-128B in conjunction with the aircraft's heading, vertical references, and position and velocity updates from its internal GPS, provides accurate aircraft velocity, position and steering information from ground level to 10,000 feet. The system provides world-wide navigation, with position readout available in both Military Grid Reference System (MGRS) and Latitude and Longitude (LAT/LONG) coordinates. Navigation and steering is performed using LAT/LONG coordinates and a bilateral MGRS-LAT/LONG conversion routine is provided for MGRS operation. Up to 100 destinations may be entered in either format and not necessarily the same format.

3-61.2. Controls, Displays and Function.

The control and displays for the AN/ASN-128B are on the front panel (figure 3.15.1). The function of each control is as follows:

**NOTE**

The MODE switch is locked in the OFF position and must be pulled out and turned to get into or out of OFF position.

CONTROL/ INDICATOR	FUNCTION
MODE switch	Selects navigation set mode of operation.
OFF	in this position the navigation set is inoperable; non-volatile RAM retains stored data.
LAMP TEST	Checks operation of all lamps.
TEST	Initiates built-in-self-test exercise for the Doppler and GPS functions of the navigation set.

CONTROL/ INDICATOR	FUNCTION
MGRS	Selects Military Grid-Reference Systems (MGRS) navigational mode of operation.
LAT/LONG	Selects latitude/longitude navigational mode of operation.
GPS LDG	Places navigation set in GPS landing mode of operation. This mode provides real-time, tactical precision landing guidance information to the HSI indicator.
DISPLAY switch	Selects navigation data for display.
<u>WIND-UTC DATA</u>	Used for wind speed and direction, UTC time, sea current, surface wind, GPS status and data load functions.
XTK/TKE KEY	Displays steering (cross track distance and track angle error) information and GPS variable key status. Selection of fly to destination by direct entry of two digit destination number.
<u>GS/TK NAV M</u>	Displays ground speed, track angle and selection of GPS and navigation mode.
PP	Displays present position, altitude and magnetic variation.
<u>DIST BRG TIME</u>	Displays distance, bearing and time information to the destination or course selected. Selection of fly to destination can be accomplished by direct entry of two digit destination number.

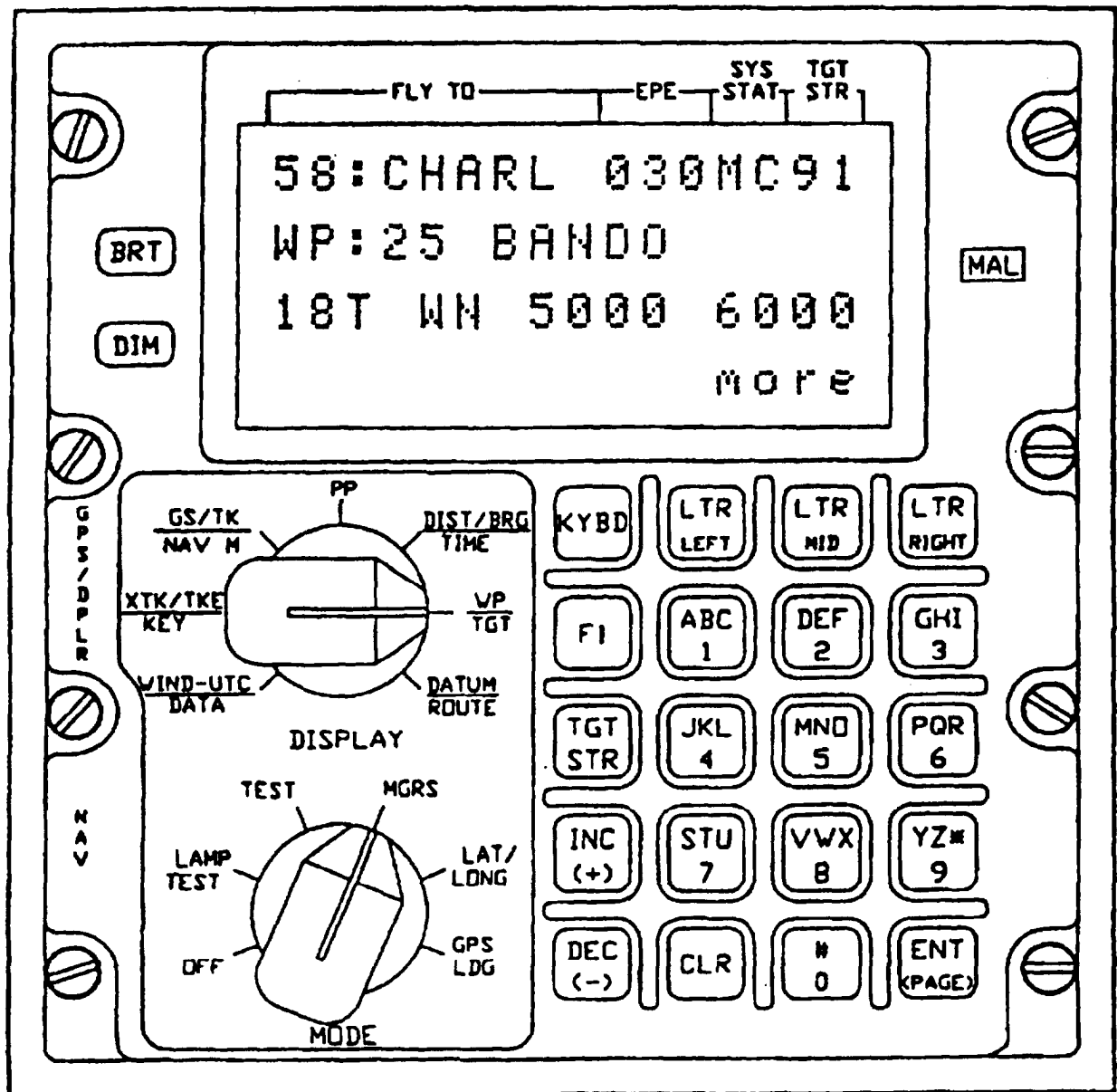


Figure 3-15.1. Doppler/GPS Navigation System AN/ASN-128B

CONTROL/ INDICATOR	FUNCTION	CONTROL/ INDICATOR	FUNCTION
<u>WP</u> <u>TGT</u>	Accesses way point or target data (landing data, variation, motion). Selection of destination for display/entry by direct entry of two digit destination number.	Keyboard and LTR Keys	Used to set up data for entry into memory. When DISPLAY switch is set to a position in which new data is required and KYBD key is pressed, data may be displayed on the appropriate input field of display. To display a number, press the corresponding key or keys (0 through 9). To display a letter, first depress the LTR key corresponding to the position of the desired letter on a key. Then depress the key which contains the desired letter. Example: To enter an L, First depress the LTR RIGHT key, then depress the 4 key.
<u>DATUM</u> <u>ROUTE</u>	Accesses datum and steering/route functions.		
MAL Indicator Lamp	Lights when a navigation set malfunction is detected by the built-in-test circuitry. In the event of an intermittent malfunction, the system may operate correctly but must be cycled to OFF position then to on, to extinguish the MAL light.		
BRT and DIM Keys	Used to brighten or dim the light intensity of the LCD display.	INC and DEC Keys	Used to increment or decrement the displayed Waypoint/Target number when the DISPLAY switch is set to WP/TGT. To access P, depress the LTR LEFT key followed by the 6 key, display way point 99 then depress the INC key, or display way point 00 then depress the DEC key. Also used to increment or decrement the Fly-To destination number when the DISPLAY switch is set to DIST/BRG/TIME or XTK/TKE/KEY.
Four Line Alpha-Numeric Display	Displays alphanumeric characters, as determined by the setting of the DISPLAY switch, the MODE switch and operation. keyboard. The keys activate function upon release and are to be released immediately after being depressed.		
TGT STR Key	Stores present position data in the indicated target store\memory location (90-99) when depressed and released.	ENT Key	Enters data into memory (as set up on keyboard and displayed). This key is also used for paging of displays. The bottom right corner of the display indicates "more" when additional pages are available, and "end" when no additional pages are available.
KYBD Key	Used in conjunction with the keyboard to allow data display and entry into the computer.	CLR Key	Clears last entered character when pressed once. When pressed twice, clears entire input field of display keyboard control.
		F1 Key	Reserved for future growth.

### 3-61.3. Modes of Operation.

Control of the AN/ASN-128B, including selection of modes and displays, and entry and readout of data is performed via the Computer Display Unit (CDU) front panel. The AN/ASN-128B has four basic modes of operation: off, navigate, test and GPS landing. In navigate mode three submodes may be selected manually or automatically. These are combined mode (default or primary mode of operation), GPS only mode, or Doppler only mode.

#### 3-61.4. Off Mode.

In the off mode the system is inoperable. However, the Edge lighting is lighted by an external aircraft power source and is independent of the AN/ASN-128B mode switch setting. Edge lighting may not be available if the helicopter is modified with the night vision MWO.

#### 3-61.5. Navigate Mode.

In the navigate mode (MGRS or LAT/LONG) position of the CDU MODE switch) power is applied to all system components, and all required outputs and functions are provided. The Doppler radar velocity sensor (DRVS) measures aircraft velocity, and converts analog heading, pitch and roll into digital form. This data and Embedded GPS Receiver (EGR) velocity and position data are then sent to the CDU for processing. Baro altitude is used for aiding the GPS when only three space vehicles are available. Present position is computed by using one of three navigation submodes which can be selected manually or automatically. These submodes are as follows:

##### 3-61.5.1. Combined Mode (Default or Primary Mode of Operation).

Doppler and GPS position and velocity data are combined to provide navigation. This mode is used when a minimum of three (with baro) or four space vehicles are available, GPS Estimated Position Error (EPE) is less than approximately 150 meters, and the Doppler is not in memory. If GPS becomes invalid (e.g., due to increased EPE), the AN-ASN-128B will automatically switch to Doppler mode until a valid GPS status is received. If the Doppler becomes invalid (e.g., flight over glassy smooth water causing memory), the AN/ASN-128B will automatically switch to GPS mode if GPS is valid or an alternate Doppler mode if the GPS is not valid.

##### 3-61.5.2. GPS Mode.

GPS positions and velocities are used for navigation by the Doppler navigation processor in the CDU. If GPS mode is

selected and the GPS becomes invalid (para. 3-61.5.1 above), the AN/ASN-128B will not navigate.

#### 3-61.5.3. Doppler Mode.

Doppler position and velocity data are used for navigation. If Doppler mode is selected and the Doppler becomes invalid (para. 3-61.5.1 above), the AN/ASN-128B will automatically switch remembered velocity since a TAS sensor is not available. If Doppler mode is manually selected at the start of the flight an initial present position must be obtained and entered prior to flight. Navigation is performed in latitude/longitude for computational convenience only. At the same time, distance, bearing and time-to-go to any one of 100 preset destinations are computed (as selected by FLY-TO-DEST).

#### 3-61.6. Test Mode.

The test mode contains two functions: LAMP TEST, in which all display segments are lit; and TEST, in which system operation is verified. In lamp test, system operation is identical to that of the navigate mode except that all lamp segments and the MAL indicator lamp are lighted to verify their operation. In TEST, the RTA no longer transmits or receives electromagnetic energy; instead, self generated test signals are inserted into the electronics to verify operation of the DRVS. At this time a self test is performed by the GPS and navigation computations continue using remembered velocity. In the TEST mode, Doppler test results are displayed on the CDU front panel for the first 15 seconds (approximate). At the end of this period either GO ALL is displayed if there is no malfunction in the navigation set, or a failure code is displayed if a malfunction has occurred. A rotating bar on the display indicates that the GPS has not completed self test. If the navigation set is maintained in the TEST mode, no navigation data can be displayed on the CDU front panel. If a Doppler malfunction is detected, the MAL indicator lamp lights and DF is displayed. At the completion of GPS self test (up to two minutes), the rotating bar is replaced with a complete test result code. The failed unit and the failed circuit card are also indicated by a code on the CDU display.

The CDU is continuously monitored for failures, using its own computer as built-in-test-equipment (BITE). Any BITE malfunction the MAL indicator lamp on the CDU to light. If the MODE switch on the CDU is set to TEST, identification of the failed LRU is indicated by a code on the display panel. Aircraft heading, pitch and roll are also displayed in this mode by depressing the ENT key after Doppler test is completed. GPS test status is displayed if the ENT key is depressed a second time. Malfunction codes are automatically latched and can only be cleared by recycling the CDU power via the CDU mode switch (OFF/ON).

### 3-61.7. GPS Landing Mode.

In the GPS landing mode, the Doppler navigation system provides information to the HSI indicator for real-time landing guidance to a touch down point previously entered in any of the 100 fly-to destinations. The landing approach is determined by present position and the entered touch down altitude, glideslope and inbound approach course.

### 3-61.6. CDU Operation.

Various required operating data, such as initial present position (if GPS is not valid or Doppler mode is selected), destination coordinates with or without GPS landing data, and magnetic variation can at any time be entered into the CDU via its keyboard, or the dataloader via the preprogrammed dataloader cartridge. In most cases, these data will be entered before the aircraft takes off.

The GPS provides present position to the AN/ASN-128B. If GPS is not available or Doppler is selected present position can be initialized as follows:

The MODE switch should be set to MGRS or LAT/LONG, the WT/TGT display position of the DISPLAY switch is selected, the destination number is set to P and KYBD key is pressed. The coordinates of the initial position is overflown, the ENT key is pressed. The computer then determines changes from the initial position continuously, and the coordinates of the current present position can be read either by remaining in this configuration or by setting the DISPLAY switch to PP (present position) and the MODE switch to MGRS or LAT/LONG.

To update present position over a stored destination, KYBD key is depressed and released when the aircraft overflies this destination. If an update is desired. the ENT key is depressed and released and the update is completed. The DISPLAY switch is in the DIST/BRG/TIME position and the FLY-TO DEST is set to this destination during this process. The distance-to-go, displayed while over the stored destination, is the position error of the system at that moment.

To update present position over a fixed point not previously stored in the computer, the DISPLAY switch is placed PP and KYBD key is depressed and released as the fix point is overflown. This freezes the display while allowing computation of changes in present position to continue within the computer. If an update is required, the coordinates of the fix point are entered via the keyboard, and ENT key is

pressed. The position change which occurred since over-flying the fix point is automatically added to the fix point coordinates to complete the position update.

Magnetic variation can be entered for each destination, and the system will compute present position magnetic variation. If operation is to occur in a region with relatively constant magnetic variation, the operator enters magnetic variation only for present position and the computer will use this value throughout the flight. If MGRS data are to be entered or displayed, the MGRS datum of operation is also entered.

Target-of-opportunity data can be stored by pressing TGT STR (target store) key when the target is overflown. This operation stores the coordinates of the target in one of ten destination locations in the computer; locations 90 through 99 sequentially incrementing each time the TGT STR key is depressed. The location is displayed in the appropriate display field. The computer can keep track of individual target positions which may include speeds and directions input by the operator.

Self test of the AN/ASN-128B is accomplished using built-in-test-equipment (BITE) with the RTA, SDC, and CDU units connected and energized for normal operation. Self test enables the unit to isolate failures to one of the four main functions (RTA, SDC, CDU or EGR) or to one of the circuit cards in the SDC or CDU. Self test is accomplished as follows:

The CDU (except for the keyboard and display) is checked on a continuous basis, and any failure is displayed by the illumination of the MAL indicator lamp on the CDU. If the MODE switch on the CDU is set to the TEST position, identification of the failed circuit card in the CDU is indicated by a code on the display panel.

The DRVS and EGR are tested by setting the MODE switch on the CDU to the TEST position. Failure of the DRVS or EGR are displayed on the CDU by illumination of the MAL indicator lamp, and identification of the failed unit or circuit card is indicated by a code on the display panel of the CDU.

Continuous monitoring of the Signal Data Converter and Receiver Transmitter Antenna is provided by the system status indication. The system will not use Doppler velocities in normal operation when flying over glassy smooth water. However, if the system continues to not use Doppler (e.g., using GPS only when combined has been

selected) for excessive periods of time (e.g. more than 10 minutes) over land or rough water, then a malfunction may exist in the navigation set and the operator should set the MODE switch to TEST to determine the nature of the failure.

The display portion of the CDU is tested by illuminating all the lamp segments in each alphanumeric character in the LAMP TEST mode.

Keyboard operation is verified by observing the alphanumeric characters as the keyboard is exercised.

### 3-61.9. Route Sequencing Modes.

The system has the ability to fly a preprogrammed sequence of waypoints. This sequence can be either consecutively numbered in which case a start and end way point are entered or randomly numbered in which case all waypoints are put in a list and the start and end waypoints are entered. Both sequence modes can be flown in the order they are in the list or in the reverse order. Directions will be displayed to the way point next on the list until approximately 10 seconds before overflying the way point at which time the display will advance to the next way point and the new way point number will blink for ten seconds. One consecutive and one random sequence may be stored in the system.

### 3-61.10. To-To Route Mode.

The system has the ability to provide steering information onto a course defined by the start and end waypoints. Only the second way point will be over flown. The distance displayed is the distance to the course when outside 2 nautical miles of the course and the distance to the second way point when inside 2 nautical miles of the course.

### 3-61.11. General Operating Procedures for Entering Data.

The panel display consists of four line LCD readout. The top line of the display is reserved for the display of Fly-To destination number and destination name/International Civil Aeronautic Organization (ICAO) identifier, EPE in meters, mode of GPS and mode of AN/ASN-128B operation and target store number. The remaining lines will display data in accordance with the DISPLAY and MODE switches. When depressing the KYBD key for the first time in an entry procedure, the display freezes, kybd is displayed in the bottom right corner indicating the display is in the keyboard mode and the input field under keyboard control blinks. If it is not desired to change the display field under control, the pilot can advance to the next field of the display by depressing the KYBD key again. Depressing the ENT key (whether or not

new data has been entered) causes the display to blank momentarily and return with the latest computed data. To abort a keyboard operation, move the mode or display switch to another position.

#### NOTE

All keys activate upon release after being depressed. Keys should be depressed and immediately released in one continuous motion.

a. Data Entry. To display a letter, first depress the LTR key corresponding to the position of the desired letter on a key. Then depress the key which contains the desired letter. Foreexample, to enter an L, first depress the LTR RIGHT key, then depress the 4 key.

b. Keyboard Correction Capability. The last character entered may be cleared by depressing the CLR key. If the CLR key is depressed twice in succession, the field is cleared but remains under control (indicated by blinking) and the last valid data entered is displayed.

c. Destination Variation Constraint. The magnetic variation associated with a destination must be entered AFTER the coordinates for that destination are entered. The order of entry for present position is irrelevant.

d. Impossibility of Entering Unacceptable Data. In most cases the computer program will reject unacceptable data (for example, a MGRS area of W1 does not exist and will be rejected). If the operator attempts to insert unacceptable data, the unacceptable data will be displayed on the panel and then the selected field will blink after ENT key is pressed displaying the last valid data.

#### NOTE

The computer cannot prevent insertion of erroneous data resulting, for example, from human or map errors.

e. Procedure for Displaying Wind Speed and Direction.

#### NOTE

In MGRS mode, wind speed is displayed in km/hr; in LAT/LONG mode, wind speed is displayed in knots, Wind direction is defined as the direction from which the wind originates.

(1) Set MODE switch to LAT/LONG (MGRS may also be used).

(2) Set DISPLAY switch to WIND-UTC/DATA and observe display.



(3) The display indicates:

SP:XXXXn  
DIR:XXX°

f. Procedure for Displaying/Entering UTC and Displaying GPS Status.

(1) Set MODE switch to LAT/LONG (MGRS may also be used).

(2) Set DISPLAY switch to WIND-UTC/DATA and observe the wind speed/direction display.

(3) Depress ENT key. Observe that the CDU display indicates year XX, day XXX and indicates hours, minutes, and seconds of UTC time: XX Hours, XX Minutes, XX Seconds.

(4) To enter year, day and time depress the KYBD key to select the field for input shown as a blinking field, enter the desired data and depress the ENT key.

(5) To display GPS status depress the ENT key to display selection menu.

1> SEA CURRENT  
2> SURFACE WIND  
3> GPS STATUS  
4> DATA LOAD end

(6) To select the GPS STATUS page depress the 3 key.

(7) Observe the CDU display. The display indicated the GPS test mode status as of one of the following:

GPS TEST: IN PROCESS  
GPS TEST: NOT RUN  
GPS TEST: PASSED  
GPS TEST: FAILED

g. Procedure for Displaying GPS Key and GPS Space Vehicle Status.

(1) Set the DISPLAY switch to XTK/TKE/KEY.

(2) Set the MODE switch to LAT/LONG (MGRS may also be used).

(3) The display indicates GPS daily key status, time remaining on the currently entered keys and how many Space Vehicles (SV) are currently being used by the GPS.

KEY	STATUS	TIME	REMARKS
DK	OK	Days or hours still available on key	GPS daily key in use and verified
DK	NO	*	No GPS daily key available
DK	IN	*	GPS daily key available but not verified

### 3-61.12. Preflight Procedures.

a. Data Required Prior to DGNS Turn-on

The following initial data must be entered by the pilot after system turn-on and initialization, unless previously entered data is satisfactory:

Datums of operation, when using MGRS coordinates. This data may be part of the data load if preprogrammed.

In combined or GPS mode the GPS provides preset position. If the Doppler only mode is selected MGRS coordinates of present position - zone area, easting and northing; latitude/longitude coordinates may also be used to input present position. This data may be part of the data load if preprogrammed. Variation of present position to the nearest one-tenth of a degree.

Coordinates of desired destinations 00 through 99. It is not necessary to enter all destinations in the same coordinate system. This data may be part of the data load if preprogrammed.

Variation of destinations to the nearest one-tenth of a degree.

Crypto-Key variables necessary to enable the GPS receiver to operate in Y code are entered via remote fill data only and not via the CDU keyboard.

#### NOTE

Destinations are entered manually when steering information is required to a destination that was not in the set of data loaded via the data loader, or it is desired to update present position by overflying a destination, or a present position variation computation is desired. (See CDU operation). If a present position variation update is desired, destination variation must be entered. The operator may enter one or more destination variations: it is not necessary for all destinations to have associated variations entered and also not

necessary to enter all destinations in any case, but variations must be entered AFTER destination coordinates are entered.

The Doppler outputs true heading and accepts magnetic heading from gyromagnetic heading reference. If accurate magnetic variations are not applied, then navigation accuracy will be affected.

b. System Initialization

- (1) Enter GPS mode "M".

**NOTE**

You must select GPS mode "M" during initialization. If "Y" mode is selected before Crypto-Key variables are loaded the system will lock-up forever.

- (2) Perform self test (para d. below).

(3) Perform download (para c. below) of data loader cartridge if necessary, or manually enter datum, destinations, magnetic variations, and present position (para f. org. below).

(4) Load Crypto-Key variables (unless previously loaded and still valid) necessary for operation of the GPS in Y mode.

**NOTE**

It is necessary to wait at least 12 minutes for key validation when new keys have been entered, or collection of almanac data when set has no previous almanac data. During this time the GPS operating mode must be M and uninterrupted. After this time the GPS operating mode may be switched to Y. Observe the GPS Key status and number of SVs tracked after switching to Y mode. If the SV number goes to zero repeat this procedure. The Key status shall switch from DK IN to DK OK sometime during the 12 minutes.

(5) Check datum of operation, if MGRS is being used.

(6) Check destinations in MGRS or LAT/LONG coordinates as desired.

(7) Check associated destination variations as desired. Remove all incorrect variations by setting DISPLAY switch to WP/TGT, setting the destination number to appropriate destination, and depressing the KYBD key and ENT key in that order. Variations of at least two destinations must be entered for automatic variation update computation

to be performed. For accurate navigation it is advised to enter variations after each destination unless the variations are the same.

- (8) Select DGNS operating mode (para e. below).

**NOTE**

The set will automatically select combined mode (default or primary operating mode) as this allows the system to select the best possible navigation method available.

(9) Set the FLY-TO DEST to the desired destination location.

c. Procedure for Downloading Data From Dataloader Cartridge

- (1) Set the CDU mode switch to OFF.

(2) Insert the preprogrammed data loader cartridge.

(3) Set the CDU mode switch to MGRS (LAT/LONG may be used). Enter desired GPS code (M or Y) mode of operation.

(4). Set the DISPLAY switch to WIND-UTC/DATA.

(5) To display the select menu depress the ENT key twice.

- 1> SEA CURRENT
- 2> SURFACE WIND
- 3> GPS STATUS
- 4> DATA LOAD end

(6) To select the DATA LOADER page depress the 4 key.

DATA LOADER

ENTER DATA: N  
end

(7) To begin the download depress the KYBD and enter Y (yes).

(8) Observe the CDU display. The CDU shall display DOWNLOAD WAYPTS and WAIT ACK. If a transmission error occurs the CDU display shall change to ERROR-RETRYING.

(9) When the transmission is complete the CDU shall display DOWNLOAD WAYPTS COMPLETE. If this display is not obtained within one minute of beginning the download check the data programming and connections.

(10) Set the CDU mode switch to OFF, remove the data loader cartridge if desired, and then set the CDU mode switch to the desired setting.

d. Self-Test

(1) Set the MODE switch to LAMP TEST. Enter GPS mode "M" or "Y". Verify the following:

(a) All LCD on four-line display are illuminated.

(b) The MAL lamp is illuminated.

(2) Rotate the center console lighting control. Verify the following:

(a) All edge lighting is illuminated.

(b) All keyboard keys are illuminated.

(3) Set MODE switch to TEST.

(a) While test is performing, depress the DIM pushbutton several times, then the BRT pushbutton several times. The LCD display should glow dimmer then brighter. Adjust LCD display for comfortable viewing.

(h) After Doppler and/or GPS self tests have completed (approximately 15 seconds for Doppler, up to 2 minutes for GPS), one of the following displays will be observed in the left and right displays:

**NOTE**

In the event the TEST mode display is not GO ALL the system should be recycled through OFF to verify the failure is to a momentary one.

LEFT DISPLAY	RIGHT DISPLAY	REMARKS
GO		Doppler has completed Built in Test ( BIT) and is operating satisfactorily, GPS is still performing BIT (GPS has a 2 minute BIT cycle maximum). Note that a rotating bar in the display indicates that the GPS is still performing self test.
GO	ALL	The entire system has completed BIT and is operating satisfactorily.
GO	P	Pitch or Roll data is missing or exceeds 90°. In this case, pitch and roll in the computer are both set to zero and navigation in the Doppler mode continues with degrade operation. Problem may be in the vertical gyro or aircraft cabling.
NG	C.R.S. or H followed by a numeric code	A failure has occurred in the Computer Display Unit or the Signal Data. Converter Power Supply. The operator should not use the system
DN	GPS failure code	GPS has failed but operator can use doppler to perform all navigation.
DF	Doppler failure code	Doppler has failed. GPS is still performing self test.
GN	Doppler failure code	Doppler has failed but operator can use GPS to perform all navigation.

e. Procedure for Displaying or Selecting GPS M or Y Operating Mode, Doppler, GPS, or Combined Operation, and Displaying Groundspeed and Track.

(1) Set MODE switch to MGRS position (LAT/LONG or GPS LDG position may also be used).

(2) Set DISPLAY switch to GS/TK/NAV M.

(3) The display indicates the current GPS and navigation mode on the top line:

(a) Selected Fly to waypoint.

(b) EPE (GPS Estimated Position Error in Meters. An asterisk (\*) in the character position of the EPE display indicates an EPE of greater than 999 or data unavailable.

(c) GPS mode of operation:

M for mixed C/A and P/Y code GPS reception

Y for only Y code GPS reception

(d) DGNS mode of operation:

C for combined Doppler and GPS

D for Doppler only

G for GPS only

R for remembered velocities

\* for no navigation.

(e) Target destination where the present position will be stored next time TGT/STR is depressed.

**NOTE**

In MGRS mode, ground speed is displayed in km/hr; in LAT/LONG mode, ground speed is displayed in knots.

Only mode C, G, and D may be selected as the primary navigation mode. Modes R and \* are automatic fall back modes used when both the Doppler and GPS are unavailable.

(4) Selection of GPS mode of operation:

As an example, consider selection of Y-only mode. Depress KYBD key. Observe that the GPS mode blinks. To enter Y (for Y mode) depress key LTR LEFT followed by key

9. A Y will be displayed. Depress ENT key. The entire display will blank out for less than one second and the center display will now indicate: Y.

(5) Selection of DGNS mode of operation:

As an example, consider selection of GPS-only mode of operation. Depress KYBD key twice. Observe that the DGNS mode blinks. To enter G (for GPS mode) depress key LTR LEFT followed by key 3. A G will be displayed. Depress ENT key. The entire display will blank out for less than one second and the DGNS Mode will now indicate: G (or \* if GPS is not available).

(6) Ground Speed and Ground Track Angle are displayed on lines 3 and 4.

f. Procedure for Entering/Displaying Present Position or One of the 100 Possible Destinations in MGRS

The DGNS has the capability to display 100 destinations (numbered 00 through 99).

100 destinations

-00 to 69 Standard Waypoints

-70 to 89 Data Load-only Waypoints, Observable but not changeable via CDU keyboard. Used for National Airspace Data Such as VORs, NDBs. and intersections.

-90 to 99 Target Store Waypoints (Usable as Standard Waypoints)

As an example, consider display of destination number 25.

(1) Enterdatum asdescribed in paragraph j below.

(2) Set MODE switch to MGRS.

(3) Set DISPLAY switch to WP/TGT.

(4) Notice the current destination number displayed. To display destination number 25 depress the INC or DEC keys, or depress keys 2 then 5. This is a direct key entry action.

(5) Observe that the current destination MGRS zone, area, and easting/northing coordinates are now displayed. The destination number 25 and location name/ICAO identifier also appears in the display.

(6) Entry for destination coordinates and location name/ICAO identifier: As an example, consider entry of zone 18T, area WN, easting 5000, northing 6000, and ICAO identifier BANDO.

(7) To enter keyboard mode depress the KYBD key. Observe "kybd" displayed in the bottom right corner of the display. (Destination number blinks.) Depress KYBD again. (Zone field blinks.) To enter 18T depress keys 1,8, LTR MID. 7.

(8) Depress KYBD. (Area and northing/easting blinks.) To enter WN5000 6000 depress keys LTR MID, 8 LTR MID, 5, KYBD,5,0,0,0,6,0,0,0.

(9) Depress KYBD. (Location name/ICAO identifier blinks.) To enter BANDO depress keys LTR MID, 1, LTR LEFT, 1, LTR MID, 5, LTR LEFT, 2, LTR RIGHT, 5.

(10) To store the displayed information into the selected destination display position depress the ENT key.

**NOTE**

To access P, depress the LTR LEFT key followed by the 6 key. Another way to access P is to display way point 99 then depress the INC key or display way point 00 then depress the DEC key.

Way points cannot be recalled by location name/ICAO identifier.

g. Procedure for Entering/Displaying Present Position or one of the 100 Possible Destinations in LAT/LONG.

The DGNS set has the capability to display 100 destinations (number 00 through 99).

100 destinations

-00 to 69	Standard Waypoints
-70 to 89	Data Load only Waypoints, observable but not changeable via CDU keyboard. Used for National Airspace Data such as VORs, NDBs, and intersections.
-90 to 99	Target Store Waypoints (Usable as Standard Waypoints)

As an example, consider display of destination number 25.

- (1) Enter the datum as described in paragraph j. below.
- (2) Set MODE switch to LAT/LONG.
- (3) Set DISPLAY switch TO WP/TGT.
- (4) Notice that the current destination number is displayed. To display destination number 25 depress the INC

or DEC keys, or depress keys 2 then 5. This is a direct key entry action.

(5) Observe that the current Latitude and Longitude coordinates are now displayed. The destination number 25 and location name/ICAO identifier appears in the display.

(6) Entry of destination coordinates and location name/ICAO identifier: As an example, consider entry of Latitude N41° 10.13 minutes and longitude E035° 50.27 minutes and ICAO identifier BANDO.

(7) To enter keyboard mode depress KYBD key. Observe "kybd" displayed in the bottom right corner of the display. (Destination number blinks.) Depress KYBD again. (Latitude field is blinks.) To enter N41° 10.13 depress keys N,4,1,1,0,1,3.

(8) Depress KYBD. (Longitude field blinks.) To enter E035° 50.27 depress keys E,0,3,5,5,0,2,7.

(9) Depress KYBD. (Location name/;ICAO identifier blinks.) To enter BANDO depress keys LTR MID, 1, LTR LEFT, 1, LTR MID, 5, LTR LEFT, 2, LTR RIGHT, 5.

(10) To store the displayed information into the selected destination display position depress the ENT key.

Display indicates:

N41° 10.13 E035° 50.27.

**NOTE**

To access P, depress the LTR LEFT key followed by the 6 key. Another way to access P is to display way point 99 then depress the IUNC key or display way point 00 then depress the DEC key.

Waypoints cannot be recalled by location name/ICAO identifier.

h. Procedures for Entering Variation and Landing Mode Data

(1) Set MODE switch to MGRS position-altitude entered/displayed in meters (LAT/LONG may also be used-altitude entered/displayed in feet).

(2) Set DISPLAY switch to WP/TGT position.

(3) Select the way point number desired by directly entering the two digit target number or depressing the INC/DEC keys. Observe the way point number entered and position data.

(4) Depress the ENT key and observe the way point number, variation and/or landing data if entered.

(5) To enter a magnetic variation and/or landing mode data depress the KYBD key to select the field for entry and enter the desired data as shown in steps 6 through 10 below. To end the entry operation depress the ENT key.

(6) Entry of variation: as an example, consider entry of a variation of E001.2. Depress keys E,0,0,1 and 2. The decimal point is inserted automatically. If no landing mode data is to be enter depress ENT to complete the operation. Display indicates: E001.2°

### NOTE

An asterisk appearing in the variation fielded indicates the variation is not entered. Variations may not be entered for waypoints containing target motion.

(7) The bottom two lines indicate the MSL altitude, desired glideslope, and the desired inbound approach course (IAC) to the indicated destination. As an example, consider entry of a glideslope of 8° an IAC of 270°, and an altitude of +230 meters. for destination number 25.

(8) Depress the KYBD key to blink the altitude field. Depress the INC/+ key to enter a positive altitude, depress keys 2,3,0 (the leading zeros may be omitted) for the altitude of 230 meters in the example.

(9) Depress the KYBD key to blink the glide slope field. Enter glideslope. The maximum allowable glideslope is 9 degrees. In the example enter 8 for an eight degree glideslope.

(10) Depress the KYBD key to blink the inbound approach course field. Enter a three digit inbound approach course angle. In the example enter 2,7,0 to enter a 270 degree inbound approach course. Depress the ENT key to complete the operation.

#### i. Procedures for Entering Target Motion and Direction

In MGRS mode, target speed is entered in km/h; in LAT/LONG mode, target speed is entered in knots.

(1) Set the MODE switch to LAT/LONG (MGRS may be used).

(2) Set the DISPLAY switch to WP/TGT and select the target number desired (00-69 or 90-99) by directly entering the two digit target number or INC/DEC keys. Observe the way point number entered and position data.

(3) Depress the ENT key and observe the way point number, variation and/or landing data if entered.

(4) Depress the ENT key and observe the target speed and direction page.

(5) To select target speed depress the KYBD key twice and enter the target speed. The maximum target speed that may be entered is 50 knots. Fill leading zeros before entering.

(6) To select the target direction depress the KYBD key and enter the target direction.

(7) To end the entry operation depress the ENT key. At the time the ENT key is depressed and released, the target position will begin to be updated as a function of time based on the speed and direction entered.

### NOTE

To abort/cancel and entry of target motion. enter a target speed of 000 using the above procedure.

#### j. Procedure for Entering/Displaying Datum or Clearing All Waypoints

(1) Set the MODE switch to MGRS position (LAT/LONG may also be used).

(2) Set the DISPLAY switch to DATUM/ROUTE.

(3) To select the datum field depress the KYBD KEY.

(4) Entry of datum: as an example consider entry of 25. Depress keys LTR 2,5. Depress the ENT key. the display shall show DATUM:25.

(5) To clear all waypoints, variations, landing data and target motions, enter RDW for the spheroid.

#### k. Procedure for Entering Sea Current Speed and Direction for Water Motion Correction.

### NOTE

In MGRS mode, wind speed is displayed in km/hr; in LAT/LONG mode, wind speed is displayed in knots. Leading zeros must be entered. Sea current direction is defined as the direction the current is flowing.

(1) Set MODE switch to LAT/LONG (MGRS may be used).

(2) Set DISPLAY switch to WIND-UTC/DATA and observe the standard wind speed and direction display.

(3) Depress the ENT key twice to display the selection menu

- 1> SEA CURRENT
- 2> SURFACE WIND
- 3> GPS STATUS
- 4> DATA LOAD end

(4) Depress the 1 key to select SEA CURRENT. The display indicates:

SEA CURRENT  
SP:XXXn  
DIR:XXX°

(5) Entry of sea current speed and direction: as an example, consider the entry of 4 knots and 135 degrees. Depress KYBD key. Observe that the speed field blinks.

(6) To enter speed, depress keys 0,0 and 4. The speed indicates 004Kn. The maximum sea current speed that may be entered is 50 knots.

(7) Depress KYBD key. The direction display blinks.

(8) To enter direction, depress keys 1, 3, and 5. Direction indicates 135°.

(9) Depress ENT key. The display momentarily blinks and then reappears.

**NOTE**

To abort entry of sea current, enter a sea current speed of 000 using the above procedure.

1. Procedure for Entering Surface Wind Speed and Direction for Water Motion Correction.

**NOTE**

Not required or necessary when in combined or GPS mode. In MGRS mode, surface wind speed is entered in km/hr; in LAT/LONG mode, surface wind speed is entered in knots. Leading zeros must be entered. Wind direction is defined as the direction from which the wind originates.

(1) Set MODE switch to LAT/LONG (MGRS may also be used).

(2) Set DISPLAY switch to WIND-UTC/DATA and observe the wind speed/direction display.

(3) Depress the ENT key twice to display the selection menu.

- 1> SEA CURRENT
- 2> SURFACE WIND

- 3> GPS STATUS
- 4> DATA LOAD end

(4) Depress the 2 key to select SURFACE WIND. The display indicates:

SURFACE WIND  
SP:XXXKn  
DIR:XXX°

(5) Entry of wind speed and direction: as an example, consider the entry of 20 knots and 150 degrees. Depress KYBD key. Observe that the wind speed field blinks.

(6) To enter speed, depress keys 0, 2 and 0. The wind speed indicates 020. The maximum surface wind speed is 50 knots.

(7) Depress KYBD key. The direction display blinks.

(8) To enter direction, depress keys 1, 5, and 0. Wind direction indicates 150°.

(9) Depress ENT key. The display momentarily blinks and then reappears.

**NOTE**

To abort entry of surface wind speed and direction, enter a surface wind speed of 000 using the above procedure.

**3-61.13. Flight Procedures.**

**NOTE**

This procedure is applicable to the Doppler only mode. Present position is automatically updated when DGNS is in combined mode.

- a. Updating Present Position from a Stored Destination

**NOTE**

The preface is: The aircraft is flying to a destination, that is, the FLY-TO Destination is set to the number of the desired destination.

(1) Set DISPLAY switch to DIST/BRG/TIME position. Distance, bearing and time-to-go to the fly-to destination are displayed.

(2) When the aircraft is over the destination, depress KYBD key. Observe that the display freezes.

(3) Position update can be effected by depressing the ENT key. The computer updated the present position at the time the KYBD key was depressed by using the stored destination coordinates, and adding to them the distance traveled between the time the KYBD key was depressed and the ENT key was depressed. In addition, if an associated variation for the stored destination exists, the present position variation is also updated.

(4) If a present position update is unnecessary (as indicated by an appropriately small value of DISTANCE to go on overflying the destination), set the DISPLAY switches to some other position - this action aborts the update mode.

b. Updating Present Position from a Landmark

**NOTE**

There are two methods for updating present position from a landmark. Method 1 is particularly useful if the landmark comes up unexpectedly and the operator needs time to determine the coordinates. Method 2 is useful when a landmark update is anticipated.

Method 1 (Unexpected update)

(1) Set DISPLAY switch to PP position.

(2) Overfly landmark and depress KYBD key. The present position display shall freeze.

(3) Compare landmark coordinates with those on display.

(4) If the difference warrants an update, enter the landmark coordinates by depressing the KYBD key to blink the field to be changed, enter coordinates, then depress the ENT key. The computer updates the present position (from the time the KYBD key was depressed) to the landmark coordinates, and adds to the updated present position the distance traveled between the time the KYBD key was depressed and the ENT key was depressed.

(5) If an update is not desired, set the DISPLAY switch to some other position. This action aborts the update mode.

Method 2 (Anticipated update)

(1) Set DISPLAY switch to WP/TGT position.

(2) Access P by depressing the LTR LEFT key followed by the 6 key, entering destination 00 then depressing the DEC key, or entering destination 99 then depressing the INC key.

(3) Depress KYBD key. Observe that the display freezes.

(4) Manually enter the landmark coordinates by depressing the KYBD key to blink the field to be changed and enter the coordinates.

(5) When overflying landmark, depress ENT key.

(6) If an update is not desired, set the DISPLAY switch to some other position. This action aborts the update mode.

**3-61.14. Fly-To Destination Operation.**

a. Initialization of Desired Course

When a fly-to destination is selected such as at the start of a leg, the present position at the time is stored in the computer. A course is then computed between the selected point and the destination. If the aircraft deviates from this desired course, the lateral offset or crosstrack distance error is computed.

Distance and bearing to destination, actual track angle, and track angle error correction are computed from present position to destination. See figure 3-15.2 for a graphic definition of these terms.

b. Procedure for Selecting One of 100 Possible Fly-To Destinations (Direct Mode)

The Doppler/GPS navigation set has the capability of selecting a fly-to destination from 100 destinations (number 00 through 99).

As an example, consider selecting Fly-To destination number 43.

(1) Set MODE switch to MGRS (LAT/LONG or GPS LDG may also be used).

(2) Set DISPLAY switch to XTK/TKE. Observe standard Cross Track (XTK) and Track angle error (TKE) display. (DIST/BRG/TIME may also be used)

(3) To display Fly-To destination 43 depress the INC or DEC keys, or depress keys 4 then 3. This is a direct key entry action.

Left-Right Steering Signals

There are two methods the pilot may use to fly-to destination, using left-right steering signals displayed on the computer-display unit. Left-right steering signals may be used when flying the shortest distance to destination from present position (Method 1) or when flying a ground track from start of leg to destination (Method 2).



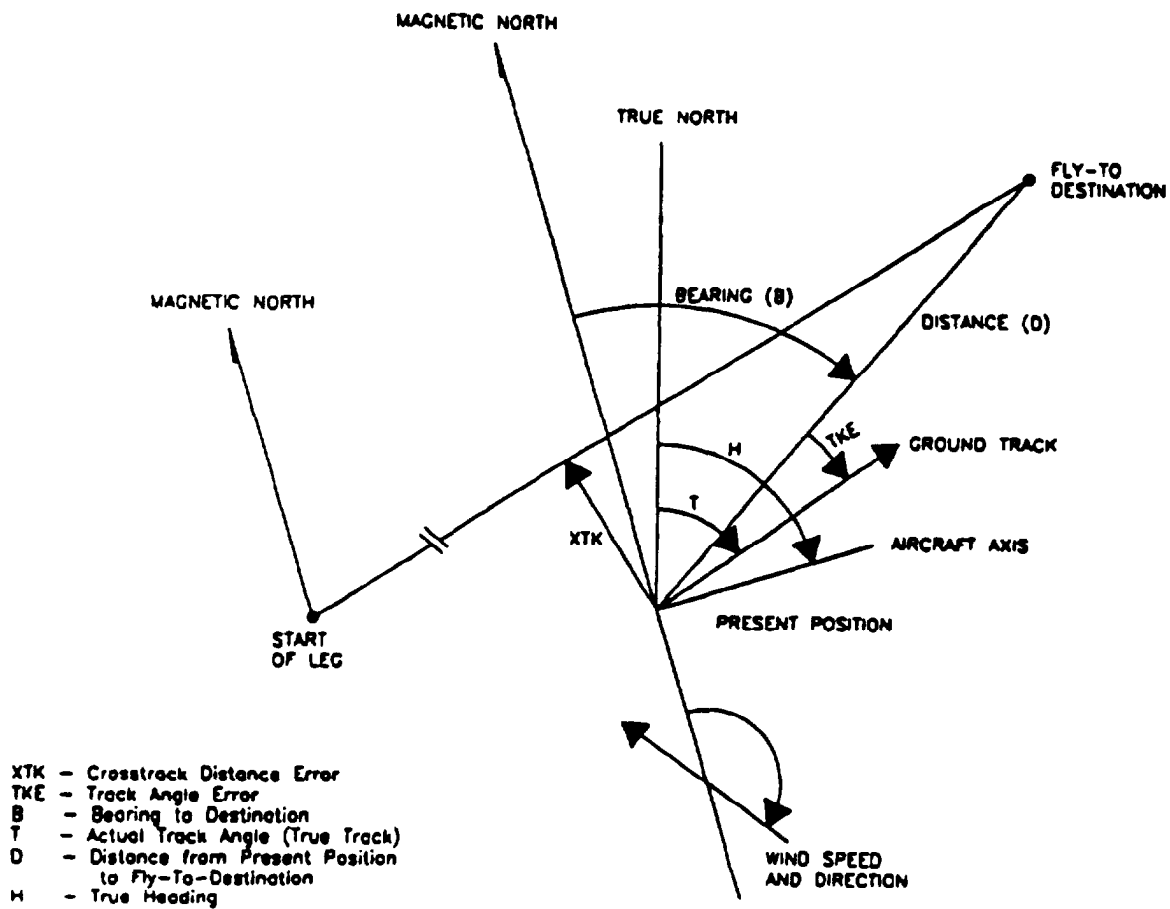


Figure 3-15.2. Graphic Definition of Course Terms

## METHOD 1

When flying shortest distance to destination from present position, set DISPLAY switch to DIS/BRG/TIME position and steer vehicle to bearing displayed. As an aid to maintaining course, set DISPLAY switch to XTK/TKE position and steer aircraft to keep track angle error (TKE) nominally zero. If the display indicates a L (left) TKE, the aircraft must be flown to the left to zero the error.

## METHOD 2

When flying a ground track, set DISPLAY switch to XTK/TKE position. Steer vehicle to obtain zero for crosstrack error (XTK). If XTK is left (L), aircraft is to right of the desired course and must be flown to the left to regain the initial course.

**NOTE**

Since the aircraft has the Horizontal Situation Indicator (HSI) and when the Doppler has been selected then the pilot may use the "#1" needle and course deviation indicator (CDI) for navigation to the Fly-To destination selected on the CDU.

Select CDI by depressing, then releasing the DPLR GPS lens on the HSI Mode Select Panel.

## c. Procedure to Enter Route-Sequence To-To Mode

The Doppler/GPS navigation set has the capability to navigate a course set up between to destinations.

As an example, consider navigating onto a course starting from destination number 62 and ending at destination number 45.

(1) Set MODE switch to MGRS (LAT/LONG may also be used).

(2) Set DISPLAY switch to DATUM/ROUTE.

(3) Depress the ENT key. Observe that a menu of special steering functions appears.

(4) To select the Route-Sequence To-To display depress key 1. Observe that TO-TO and selection mode appears in the display. The display provides entry of starting and ending destination numbers.

(5) To enter keyboard mode depress the KYBD key. (START field blinks.) To enter starting destination 62 depress keys 6, 2.

(6) Depress KYBD key. (END field blinks.) To enter ending destination 45 depress keys 4, 5.

(7) Depress KYBD key. (SELECT field blinks.) Enter Y (yes) for mode selection. N may be entered to arm the system with the start and end destinations but without entering the Route-Sequence To-To mode, or to exit the route-Sequence To-To mode if the system is currently in that mode.

**NOTE**

If an entry is changed after Y is entered for selection, and N must be entered for the selection then it may be changed to Y. The sequence must be flown from the beginning waypoint.

No target destinations or destinations with target motion may be included as To-To waypoints.

## d. Procedure to Enter Route-Sequence Random Mode

The Doppler/GPS navigation set has the capability to navigate through a sequence of randomly number destinations.

As an example, consider navigating through destination numbers 32, 25, 74, 01, 48, 83, 35.

(1) Set MODE switch to MGRS (LAT/LONG may also be used).

(2) Set DISPLAY switch to DATUM/ROUTE.

(3) Depress the ENT key. Observe that a menu of special steering functions appears.

(4) To select the Route-Sequence Random display depress key 2. Observe that RT SEQ RANDOM now appears in the display followed by the sequence of destination numbers and a continuation prompt.

(5) Enter the sequence of destination numbers by depressing the KYBD key to enter keyboard mode. (First destination field is blinks.) To enter first destination 32 depress keys 3, 2.

(6) Depress KYBD key. (next destination field is blinked.) Depress keys 2., 5 to enter second destination 25.

(7) Repeat step 6 until a maximum of ten destinations are entered or if less than ten need to entered, asterisks are left for remaining destinations.

(8) To complete the entry of the random sequence of waypoints depress ENT key.

(9) Depress ENT key to select next page.

(10) To select the start field and enter the starting destination depress KYBD key.

(11) To select the ending field and enter the ending destination depress KYBD key.

(12) Depress KYBD key. (SELECT field blinks.) Enter Y (yes) for mode selection. N may be entered to arm the system but without entering the Route-Sequence Random mode, or to exit the Route-Sequence Random mode if the system is currently in that mode. An entry Y and R indicates a choice of Y-flying in forward order, or R-flying in reverse order. To clear the random sequence, enter a C for selection.

**NOTE**

If an entry is changed after Y or R is entered for selection, an N must be entered for the selection then it may be changed to Y or R. The sequence must be flown from the beginning waypoint. No target destinations or destinations with target motion may be included as Route sequence random waypoints.

(13) After all entries are made, depress ENT key.

e. Procedure to Enter Route-Sequence-Consecutive Mode

The Doppler/GPS navigation set has the capability to navigate through a sequence of consecutively numbered destinations.

As an example, consider navigating through destination numbers 32 through 35.

(1) Set MODE switch to MGRS (LAT/LONG may also be used).

(2) Set DISPLAY switch to DATUM/ROUTE.

(3) Depress the ENT key. Observe that a menu of special steering functions appears.

(4) To select the Route-Sequence-Consecutive display depress key 3. Observe that RT SEQ CONSEC now appears in the display, followed by starting and ending destination numbers, and mode selection.

(5) To enter keyboard mode depress the KYBD key. (START field blinks.) To enter starting destination 32 depress keys 3, 2

(6) Depress KYBD key. (END field blinks.) Depress keys 3, 5 to enter ending destination 35.

(7) Depress KYBD key. (SELECT field blinks.) Enter Y (yes) for mode selection. N may be entered to arm the system but without entering the Route-Sequence-Consecutive mode, or to exit the Route-Sequence-Consecutive mode if the system is currently in that mode. An entry of Y and R indicates a choice of Y-flying in the forward order, or R-flying in reverse order.

**NOTE**

If an entry is changed after Y or R is entered for selection, and N must be entered for the selection then it may be changed to Y or R. The sequence must be flown from the beginning waypoint. No target destinations or destinations with target motion may be included as Route sequence consecutive waypoints.

f. Procedure for Displaying Distance/Bearing/Time Information

(1) Set MODE switch to MGRS (LAT/LONG or GPS LDG may also be used)

(2) Set DISPLAY switch to DIS/BRG/TIME.

(3) Observe that the distance-to-go in kilometers (to the fly-to destination), bearing, and time-to-go appears on the bottom two lines of the display. (Distance is in nautical miles when MODE switch position is LAT/LONG.) Bearing-to-destination is displayed in degrees, and the time-to-go is displayed in hours, minutes, and tenths of a minute.

(4) The display of the second line depends on the current steering mode as follows:

(a) Direct-To Steering (default): Fly-to destination number and ICAO identifier are displayed. Example: 58:BANDO

(b) To-To Steering: TO-TO-:XX TO YY where XX is the 'To-To' start-of-leg destination number, and YY is the 'To-To' fly-to destination number.

(c) Route-Sequence Steering (both consecutive and random): RT-RANDOM:XXTOYY where XX is the current Route-Sequence fly-to destination number, and YY is the next destination number in the sequence. Approximately 10 seconds before overflying the fly-to destination, the system automatically 'pickles' to the next destination, and the new fly-to number blinks for 10 seconds then stops blinking.

g. Procedure for Displaying Present Position and GPS Altitude

(1) Set the MODE switch to MGRS (LAT/LONG or GPS LDG may also be used). Set the DISPLAY switch to PP and observe present position display.

(2) To display present position variation and GPS altitude depress the ENT key. Present position variation may be entered by depressing the KYBD key to select the variation field. A variation is entered and the ENT key is depressed.

h. Target Store (TGT STR) Operation

Two methods may be used for target store operation. Method 1 is normally used when time is not available to preplan a target store operation. Method 2 is used when time is available and it is desired to store a target in a specific location.

Method 1 (uses location 90-99)

(1) Depress the TGT STR key while flying over target.

(2) Present position and variation are automatically stored in the target destination location which was displayed in the target store field immediately prior to depressing the TGT STR key.

Method 2 (uses locations 00-69 and 90-99)

(1) Set MODE switch to MGRS or LAT/LONG position, depending on coordinate from desired.

(2) Set DISPLAY switch to WP/TGT position.

(3) To access P, depress the LTR LEFT key followed by the 6 key. Another way to access P, is to display way point 99 then depress the INC key or display way point 00 then depress the DEC key.

(4) Depress KYBD key when overflying potential target. Observe that display freezes and kybd is displayed in the bottom right corner of the display indicating keyboard mode. The destination number is now under keyboard control indicated by a blinking field.

**CAUTION**

Do not depress ENT key while destination is set to P.

(5) If it is desired to store the target enter the two digit destination number and depress the ENT key.

(6) If it is not desired to store the target, set the DISPLAY switch momentarily or permanently to another position.

i. Procedure for Entering Landing Mode

(1) Set the Fly-to destination by setting the DISPLAY switch to either XTK/TKE/KEY or DIST/BRG/TIME. Directly enter the two digit destination number or use the INC or DEC keys.

(2) Set MODE switch to GPS LDG.

(3) The DISPLAY switch continues to function as before. To switch between metric and English units, depress the ENT key.

**NOTE**

In this mode, the DGNS provides real-time landing guidance information to the HSI indicator. To display course deviation indication (CDI) on VSI and HSI, depress then release the DPLR GPS button on the HSI Mode Select Panel.

j. Procedure for Transferring Stored Destination/Target Data From One Location to Another

The following procedure allows the operator to transfer stored destination/target data from one destination/target location to another destination location. The transferred data consists of destination name/ICAO identifier, location, variation, and landing information. For illustrative purposes only, it is assumed that the operator wants to put the coordinates of stored target 97 into the location for destination 12.

(1) Set DISPLAY switch to WP/TGT position.

(2) Depress keys 9 then 7.

(3) Depress KYBD key, depress keys 1 then 2.

**NOTE**

Location name/ICAO identifier, variation, and landing data may be deleted by first displaying the waypoint, depressing the KYBD key, then the ENT key.

(4) Depress ENT key.

k. Operation During and After a Power Interruption

During a power interruption, the stored destination and target data and present position are retained by non-volatile RAM inside the CDU. This makes it unnecessary to reenter any navigation data when power returns. GPS satellite data

are also retained by a rechargeable battery inside the SDC. This makes it unnecessary to reload the crypto key or wait for the collection of any almanac. Navigation will be interrupted during the absence of power; however the present position will be updated when the GPS data becomes valid provided the DGNS mode has not been selected as Doppler only. The pilot will have to re-enter the GPS operating mode (M or Y) using a single key (5 or 9).

In the event the CDU is initialized, the display will indicate only EN when the CDU is operated. This is an indication to the operator that previously stored data has been lost and that spheroid/variation, destinations, and calibration data must be entered. Present position needs to be entered only if Doppler only mode has been selected. The KYBD key must be depressed to clear the EN.

The computer initializes to the following: operating mode to combined, present position variation to E000.0, destinations and associated variations to a non-entered state, wind speed (water motion) and sea current speed to 000, DATUM: 00, present position to N45° 00.00' E000°00.00' (until updated by GPS), target store location to 91, along track calibration correction to 00.0 percent, and magnetic compass deviation corrections to 000.0 degrees. The following data must be entered:

- (1) Depress KYBD key.
- (2) Set MODE switch to OFF momentarily, to LAMP TEST for approximately one second, and then to MGRS or LAT/LONG.
- (3) Select GPS M or Y mode.
- (4) Select DGNS operating mode if other than combined.
- (5) Enter datum.
- (6) Enter present position if Doppler only has been selected.
- (7) Enter each destination and its associated variation.

1. Procedure for Displaying Aircraft Heading, Pitch, and roll (Maintenance Function)

- (1) Set the CDU mode switch to test and observe the CDU test mode display.
- (2) After the Doppler test is completed depress the ENT key.

(3) Observe the CDU display. The top indicates, in degrees and tenths of a degree, aircraft system heading, pitch, and roll.

**3-61.15. Controls and Indicators - Horizontal Situation Indicators. (fig. 3-15.3.)**

CONTROLS/ INDICATOR	FUNCTION
Compass Card	The compass card is a 360° scale that turns to display heading data obtained from the gyro magnetic compass (AN/ASN-43). The helicopter headings are read at the upper lubber line.
Bearing Pointer No. 1	The pointer operates in conjunction with doppler/GPS. Indicates magnetic bearing to doppler/GPS destination set on FLY-TO-DEST.
Bearing Pointer No. 2	The pointer operates in conjunction with selected VOR or ADF receiver. The pointer is read against the compass card and indicates the magnetic bearing to the VOR or ADF station.
Course Deviation Indicator	This indicator indicates lateral deviation from a selected VOR course or doppler computed course or heading in the case of FM homing. When the helicopter is flying to correct course, the course indicator will be aligned with the course pointer and will be centered on the fixed aircraft symbol. The two dots on either side of the indicator indicate amount of course deviation. One dot displacement is equivalent to 5° off VOR or doppler and 1 1/4 degrees off localizer course. These displacements do not apply to FM homing.

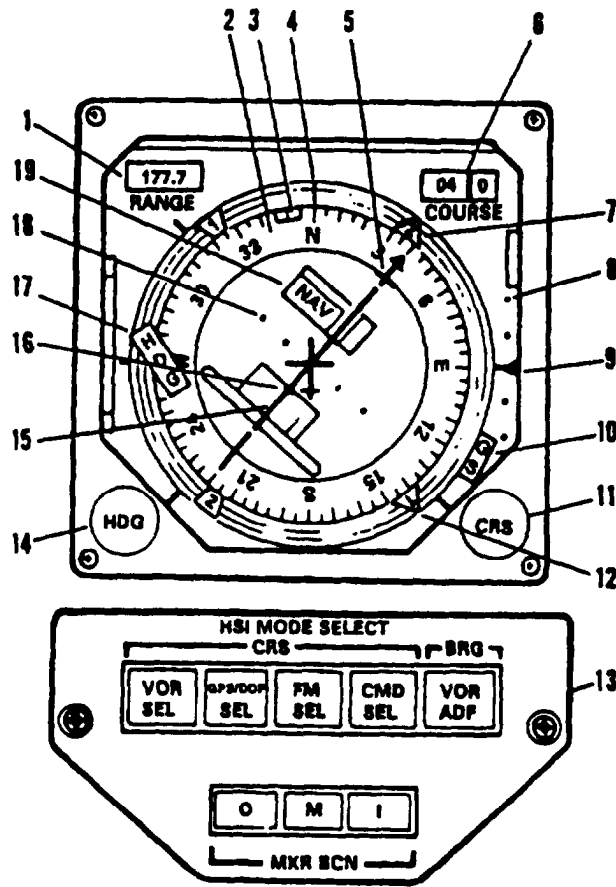
CONTROL/ INDICATOR	FUNCTION
CRS Knob Course Indicator Pointer	The COURSE indicator and course pointer operate in course conjunction with the course select (CRS) knob, and allow the pilot to select any VOR course. The course pointer turns with the compass card and will be aligned with the lubber line when the helicopter heading is the same as the selected course.
Range Indicator	Digital distance display in kilometers (KM) to destination set on doppler FLY-TODEST thumbwheel.
HDG Knob	Heading select (HDG) knob operates in conjunction with the heading bug. It allows the pilot to select any one heading. With CMD SEL (fig. 3-14) selected on the HSI MODE SELECT panel, the AFCS (chapter 2) will turn the helicopter to and maintain the selected heading.
HDG Flag	The HDG flag is in view when the signal from the gyro magnetic compass is unreliable or power to the indicator is lost.
To-From Arrow	To-from arrow indicates that the helicopter is flying to or away from a selected VOR.
NAV Flag	The NAV flag turns with the compass card. The flag will retract from view when a reliable VOR doppler or FM homing signal is being applied to the instrument.
Aircraft Symbol	Corresponds to longitudinal axis of the helicopter; shows helicopter position and heading relative to the selected course.

CONTROL/ INDICATOR	FUNCTION
Glide Slope Pointer	Displays glide slope position relative to the helicopter or FM homing signal strength. When pointer is above center, helicopter is below glide slope, conversely when pointer is below center, helicopter is above glide slope. Increasing homing signal strength is shown by pointer rising. Decreasing homing strength is shown by pointer falling.
Glide Slope (GS) Warning Flag	Indicates loss of or an unreliable glide slope or FM homing signal.

**3-61.16. Horizontal Situation Indicator Mode Select Panel. (fig. 3-15.3)**

The HSI MODE SELECT panel is on each pilots instrument panel below the HSI. The panel allows the pilot to select the navigation mode to be displayed on the HSI, command AFCS heading select feature, and visually indicates marker beacon passage. The panel is divided into three sections labeled CRS, BRG, and MKR BCN,

- a. The CRS (course) section consists of four pushbutton selector switches labeled VOR SEL, GPS/DOP SEL, FM SEL, and CMD SEL. Pressing VOR SEL, GPS/DOP SEL, or FM SEL causes the output of the selected navigation set to be electrically connected to the course deviation indicator on the corresponding HSI and lights SEL legend in the switch. These switches are electrically interlocked so only one set may be selected at a time. Selecting another navigational modes, automatically disengages the mode in use, turns out the SEL legend of the mode in use, engages the selected mode, and lights the SEL legend of the selected mode. Each pilot may independently select different navigational modes for display on his HSI.



23882

- |  |  |
|--|--|
| <ul style="list-style-type: none"> <li>1. RANGE indicator (Km)</li> <li>2. Compass card</li> <li>3. Heading Bug</li> <li>4. Lubber Line</li> <li>5. Course pointer</li> <li>6. COURSE indicator</li> <li>7. No. 2 bearing pointer</li> <li>8. Glide slope deviation marks</li> <li>9. Glide slope deviation pointer</li> </ul> | <ul style="list-style-type: none"> <li>10. GS (glide slope) failure flag</li> <li>11. CRS (course) select knob</li> <li>12. No. 1 bearing pointer</li> <li>13. HSI MODE SELECT panel</li> <li>14. HDG (heading) select knob</li> <li>15. Course deviation indicator</li> <li>16. To - from indicator</li> <li>17. HDG (heading) failure flag</li> <li>18. Course deviation marks</li> <li>19. NAV (navigation) failure warning flag</li> </ul> |
|--|--|

Figure 3-15.3. Horizontal Situation Indicator Mode Select Panel

b. Pressing CMD SEL engages the AFCS heading select feature, causes the helicopter to turn to and maintain heading to which the HSI heading bug is set, and illuminates the SEL legend on the switch. Due to electrical interlocks between the two HSI control panels, both CMD SEL switches cannot be engaged at the same time. The engaged switch is indicated by the lit SEL legend. If the opposite CMD SEL switch is pressed when operating with heading select, the HDG on the AFCS panel will release and heading select will be disengaged. Control of the course deviation indicator in the VOR mode relative to bearing and course deviation to or from a VOR is assigned to the pilot who has CMD SEL engaged. If the pilot who does not have CMD SEL engaged makes an adjustment on his CRS knob, it will have no effect on the CDI relative to the course.

c. Pressing VOR/ADF pushbutton on the BRG side selects the navigational aid, the bearing of which will be indicated by the HSI No. 2 pointer. The switch is divided into

two segments labeled VOR and ADF. If the VOR segment is lit, the No. 2 pointer will indicate the bearing to a VOR station to which the VHF navigation set is tuned. Pressing the switch will cause the VOR segment to go out and the No. 2 pointer will indicate the bearing to the station to which the ADF set is tuned out and light the ADF segment. The opposite action occurs if the ADF segment is lit and the switch is pressed.

d. A MKR BCN light will illuminate during marker beacon passage. The light labeled O comes on when passing through an outer marker beam. The light labeled M comes on when passing through a middle marker and finally the light labeled I comes on when passing through an inner marker. As each light illuminates, a distinctive tone identifying the beacon will be heard over the interphone (table 3-2). The lights have a press-to-test feature; pressing any one of the three lamps will cause all mode select panel indicator lamps to illuminate on that HSI MODE SELECT panel.



SECTION IV TRANSPONDERS

3-62. Transponder System (AN/APX-100).

The transponder system provides automatic radar identification of the helicopter. The system receives, decodes, and replies to interrogations on modes 1, 2, 3/A, 4, TEST and C from all suitably equipped challenging helicopter or ground facilities. The receiver section operates on a frequency of 1,030 MHz and the transmitter section operates on a frequency of 1,090 MHz. Because these frequencies are in the UHF band, the operational range is limited to line-of-sight. Power to operate the system is supplied by the No. 2 DC bus through the COMM IFF circuit breaker on No. 2 PDP.

The integral receiver-transmitter-control panel is on the console. It provides the control switches for application of power, setting of the -modes and codes, modes of operation, identification of position, and emergency functions of the set. It receives coded interrogating pulses and tests them for validity. If the signals conform to the preset mode and code, a coded reply is transmitted. Additional preset codes for emergency use are available when selected. These emergency codes are transmitted on modes 1,2,3/A and 4 regardless of codes selected. Transponder functions are continuously monitored by built-in-test circuits. Each mode also has a self-test feature which can be selected by the pilot to verify operation. The RT-1285/APX-100 is the interim NVG compatible control. The RT-1558/APX-100 is the NVG Blue Green version. Both units are form, fit and functionally interchangeable. The receiver-transmitter must be removed from the console to replace the fuse.

3-83. Controls and Function, Transponder Control (RT-1285/APX-100)(RT-1558/APX-100). (fig. 3-16)

CONTROLS/ INDICATOR	FUNCTION
MASTER Control Switch:	
OFF	Removes power from transponder set and computer.
STBY	Power is applied to transponder receiver and computer; transmitter inoperative. Set ready for operation after 2 minute warmup in STBY.
NORM	Transponder in normal operation.
EMER	Transmits emergency reply signals to mode 1, 2, or 3/A and 4 interrogations, regardless of mode control settings.

CONTROLS/ INDICATOR	FUNCTION
M-1, M-2, M-3/A Switches	At ON position, the applicable mode is selected for operation. OUT position turns off applicable mode. At TEST position, that particular mode is tested for proper operation. If test is valid, TEST lamp will illuminate.
M-C	In mode C, altitude information is provided to ground controllers by the AAU-32A encoding altimeter. Switch position functions are the same as for M-1, M-2, and M-3A switches.
MODE 1 Selector Switches	Selects and indicates a two digit 32 code reply number.
MODE 2 Selector Switches	Selects and indicates a 4 digit 4096 code reply number. (Switches are preset and covered by a guard. Only the reply code can be seen.)
MODE 3/A Selector Switches	Selects and indicates a 4 digit 4096 code reply number.
MODE 4 CODE Control Switch	Selects type of MODE 4 operation.
HOLD	This function is enabled only when the right aft landing gear strut is compressed. It holds the MODE 4 code which would otherwise be cleared when the set is turned off or electrical power is removed. Switch is spring-loaded to A. HOLD function is reset when the transponder is turned on.
A	Enables transponder to reply to code A interrogations.
B	Enables transponder to reply to code B interrogations.

CONTROLS/ INDICATOR	FUNCTION
ZERO	Clears (zeroizes) mode 4 code settings in transponder computer.
MODE 4 AUDIO LIGHT OUT Switch	At AUDIO, the REPLY indicator light will illuminate when the transponder replies to valid mode 4 interrogations. A pulse tone will be heard in the headset when a code A interrogation is received but the CODE control switch is in B position and vice versa. At LIGHT, only the light will illuminate when the transponder replies to mode 4 interrogations. At OUT, the audio and REPLY light monitoring is disabled.
MODE 4 TEST-ON-OUT Switch	At ON, the transponder replies to valid mode 4 interrogations. At OUT, mode is disabled. At TEST, mode 4 is tested for proper operation. If test is valid, TEST GO.
Mode 4 REPLY Light	Illuminates to indicate valid mode 4 replies when MODE 4 AUDIO LIGHT switch is set to either AUDIO or LIGHT.
TEST GO Light	Illuminates when transponder responds properly to TEST position of M-1, M-2, M-31A, M-C, or MODE 4 TEST-ON-OUT switches.
TEST/MON NO GO Light	The light illuminates when any of the following occurs: <ul style="list-style-type: none"> <li>a. MASTER switch is on STBY.</li> <li>b. Transponder does not respond to interrogation.</li> <li>c. Transponder does not respond to TEST position of mode switches.</li> <li>d. Transponder malfunctions.</li> </ul>
RAD TEST Switch	At RAD TEST, the transponder replies to interrogations from external test equipment. At OUT, the

CONTROLS/ INDICATOR	FUNCTION
IDENT-MIC Switch	RAD TEST feature is inoperative. At IDENT, the set will transmit a coded identification pulse for about 20 seconds to all interrogating stations on modes 1, 2, and 3/A to identify the helicopters position. OUT position turns off the identification pulse. MIC feature is not used in this installation.
STATUS Indicators	The indicator lights are part of built-in-test equipment. A lit ALT indicator indicates trouble in the encoding altimeter. A lit KIT indicator indicates trouble in the computer or the computer is not installed. A lit ANT indicator indicates antenna trouble.
ANT Switch	Three-position antenna diversity switch labeled TOP, DIV, and BOT. Normal position is DIV. When jamming is heavy, TOP or BOT antenna may be selected.
IFF Fail Light (Located on the center instrument panel)	The light will illuminate in MODE 4 when any of the following occurs: <ul style="list-style-type: none"> <li>a. The computer is installed without a code.</li> <li>b. No reply or improper reply is made to a valid interrogation.</li> <li>c. A malfunction occurs in the transponder.</li> </ul>

**3-64. Normal Operation - Transponder System.**  
The following steps provide transponder system operating procedures.

- a. Starting.
  - (1) MASTER control switch – STBY. Red TEST/MON NO GO light illuminates.
  - (2) Warmup – 2 minutes.
  - (3) RAD TEST switch – OUT.
  - (4) IDENT-MIC switch – OUT.
  - (5) AUDIO-LIGHT switch – OUT. (During mode 4 operation – As desired.)

- (6) M-1, M-2, M-3/A, M-C and MODE 4 switches – As required. MODE 4 switch must be OUT when computer is not installed.
- (7) MODE 4 CODE control switch – As required.
- (8) MASTER control switch – NORM,
- (9) ANT DIV switch – DIV. TEST/MON light should extinguish after 6 seconds.

b. Stopping.

- (1) If code retention is desired:
  - (a) MODE 4 CODE selector switch – HOLD, then release.
  - (b) MODE 4 CODE selector switch – A or B, as applicable.
  - (c) MASTER control switch – OFF.
- (2) If code retention is not desired:
  - (a) MODE 4 CODE selector switch – ZERO.
  - (b) MODE 4 CODE selector switch – A or B, as applicable.
  - (c) MASTER control switch – OFF.

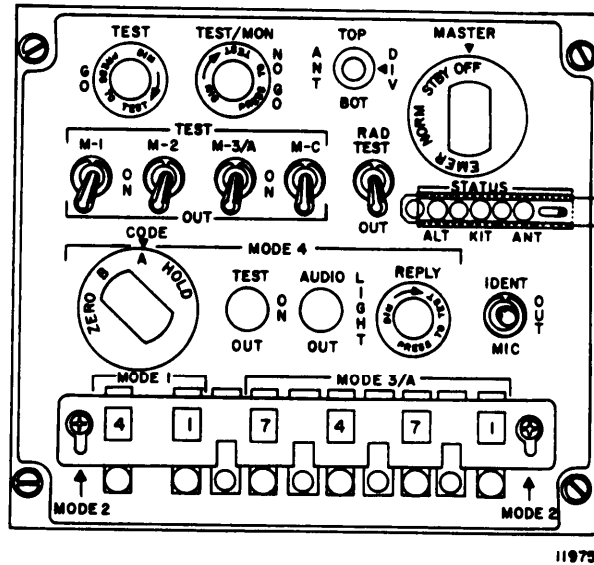


Figure 3-16. AN/APX-100 Control Panel

**3-65. AN/ASN-149(V) Global Positioning System (GPS).**

a. Description. The AN/ASN-149 Global Positioning System (GPS) shown in Figure 3-17 receives satellite signals through an antenna located on top of the aircraft above the cockpit. The GPS then calculates the aircraft's location with respect to the position of the

satellites. The aircraft location data calculated by the GPS is then used to update the INS present position of the aircraft.

b. Controls and Functions. The controls and functions for the Global Positioning System are described in Table 3-5.

**Table 3-5. AN/ASN- 149( ) GPS Controls/Indicators and Functions.**

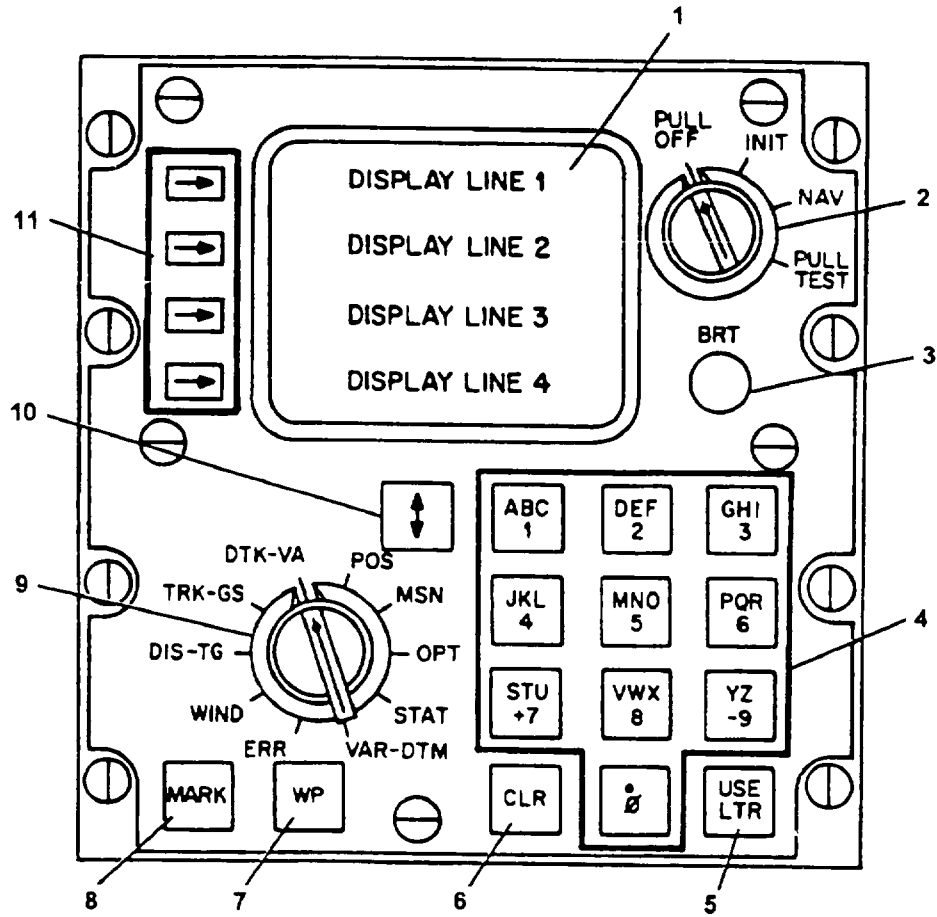
Control/Indicator	Function
Line Select → Keys	Lighted. Momentary-contact push-button switches.  Provide three functions:  Enable scratch-pad display to allow operator to enter data on display line Transfer data from scratch-display to memory. Select or cancel action displayed on the data entry display line.
Display Screen	Displays operational menus and data entry fields. Contains four display lines with each line displaying up to 13 characters.
Mode Switch	Four-position rotary switch with pull-to-turn mechanical interlock at OFF and TEST positions.
OFF	Disables Receiver and Indicator Controller power supplies. Mode switch knob must be pulled out to rotate to or from OFF position.
INIT (initialize)	Enables initialization (start-up) of the GPS.
NAV (navigation)	Enables GPS navigation functions and sends/receives outputs/receives to/from the operator and/or other on-board navigation systems.
TEST	Enables GPS self-test. Failures are isolated to assembly level and failure codes are displayed on the data display. Mode switch knob must be pulled out to rotate to or from TEST position.
BRT Control	Adjusts data display brightness.
<b>NOTE</b> Panel lighting brightness is controlled by aircraft dimmer control.	
Data Entry Keys	Lighted momentary-contact push-button switches.

**Table 3-5. AN/ASN- 149( ) GPS Controls/indicators and Functions - (Continued)**

Control/Indicator	Function
USE LTR Key	Lighted momentary-contact push-button switch. Allows letters to be selected for entry. Also terminates alphabetic data entry.
CLR (clear)	Lighted momentary-contact push-button switch. During Data entry:  One press clears last character entered. Two presses clears entire display line. Three presses exits data entry and returns original data display.
WP (Waypoint) Key	Lighted momentary-contact push-button switch.  Allows selection of destination (> ) or waypoint (WP) operation.
MARK Key	Lighted momentary-contact push-button switch. Enters present position into scratch-pad memory to either freeze position display or store position information in GPS memory.
Data Select Switch	Ten position rotary switch.
POS (position)	Allows display of resent position coordinates and altitude when D is displayed on display line 1 or waypoint position coordinates and altitude when WP is displayed on display line 1.
MSN (mission)	Allows selection of area navigation (RNAV) (stationary waypoint), rendezvous (moving waypoint) operation. Doppler aiding and GPS outputs to other aircraft systems. Operates only when > is displayed on display line 1.
OPT (option)	Allows selection of display options.
STAT (status)	Allows display of system status and performance information. Operates only when > is displayed on display line 1.
VAR-DTM (magnetic variation-map datum)	Allows display of present position magnetic variation and map datum when > is displayed on display line 1, or waypoint magnetic variation and map datum when WP is displayed on display line 1.
ERR (error)	Allows display of crosstrack, vertical and track angle errors. Operates only when > when WP is displayed on display line 1.

**Table 3-5. AN/ASN- 149( ) GPS Controls/Indicators and Functions - (Continued)**

Control/Indicator	Function
WIND	Allows display of wind speed and wind direction. Computed by GPS using drift angle, true airspeed and heading. Operates only when > is displayed on display line 1.
DIS-TG (distance-time to go)	Allows display of great circle distance, time to go, bearing and slant range to waypoint.
TRK-GS (track ground speed)	Allows display of ground track, ground speed of aircraft and time of day when > is displayed on display line 1, or display of ground track, ground speed and time of fix of moving waypoint when WP is displayed on display line 1.
DKT-VA (desired track-vertical angle)	Allows display of desired track and vertical angle to destination when > is displayed on display line 1 or desired track and angle to waypoint when WP is displayed on display line 1.
SLEW (↕) Key	Lighted momentary-contact push-button switch.  Accesses next page of multiple-page displays. Operates when double-headed arrow (↕) is displayed on right side of display line 1.



- |                       |                     |
|-----------------------|---------------------|
| 1. Data Display       | 7. Waypoint Key     |
| 2. Mode Switch        | 8. Mark Key         |
| 3. Brightness Control | 9. Data Switch      |
| 4. Data Entry Keys    | 10. Slew Key        |
| 5. Use Letter Key     | 11. Line Select KEY |
| 6. Clear Key          |                     |

Figure 3-17. AN/ASN-149( ) GPS Controls and Display Unit (CDU)

c. Operation. The GPS requires map datum, a position reference, a time reference, and almanac or ephemeris data to perform a normal start-up. Table 3-6. If the position reference is not available from internal memory or external aircraft systems the GPS will request position data be entered by the operator. If the almanac data is not available from memory or the data loader, the GPS will automatically perform a cold-start of the sky to receive satellites. The GPS begins cold-start by searching for PRN6. The search takes up to 6 minutes. If PRN6 signal is not received (tracked), the GPS will search for PRN 7. If PRN7 is not tracked in 6 minutes, the GPS will search for PRN 8. This process will continue up to PRN32 and start over at PRN1 until a good satellite is tracked.

Once a good satellite is tracked the AN/ASN149(V) receive almanac (data). This takes about 13 minutes. After which the GPS will begin normal start-up operation. Based on the above description, the time to complete a cold start is totally dependent on satellite visibility. If Start-up is being done when PRN6 is overhead and good, start-up may be completed in less than 20 minutes.

If the GPS already has current almanac, the first search pattern will be based on information contained in the almanac. For example, if the GPS contains almanac for PRN3, 9, 12 etc., it will search for PRN3 first then PRN6 etc. The time cold start takes under these conditions may be considerably less than described above; however, it is still based on satellite visibility. The start-up procedure must be performed prior to using the GPS for navigation. Before operating, be sure GPS antenna is open to the sky (TM 11-5826-308-12),

(1) Preliminary Procedures. Perform the following procedure before attempting GPS start-up.

Commanded Self-Test - Table 3-8.

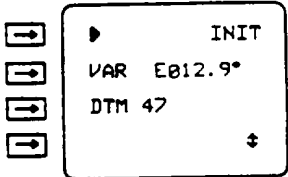
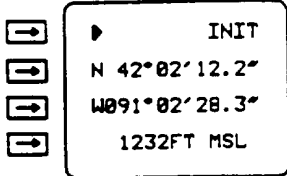
Selecting units of measurement, coordinate systems, north reference, altitude reference. Table 3-7.

**Table 3-6. AN/ASN-149(V) GPS Start-Up Procedure**

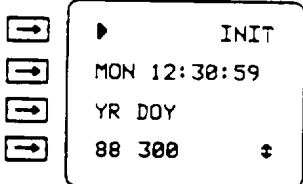
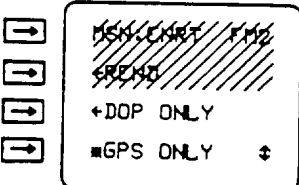
Step	Procedure	Display
a.	Set mode switch to INIT.	
<p><b>NOTE</b> Complete step b if data transfer module receptacle is installed; if not, go to step c. Transfer data takes 30 seconds. If NAV is selected before data transfer is finished, the data will be lost.</p>		
b.	Ensure data transfer module (if required) is programmed with current data, then insert data transfer module into data transfer module receptacle.	



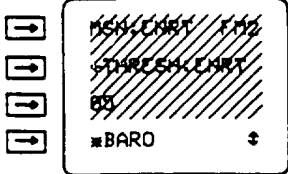
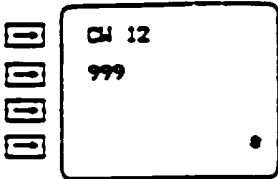
**Table 3-6. AN/ASN-149(V) GPS Stan-Up Procedure - (Continued).**

Step	Procedure	Display
	<p><b>NOTE</b></p> <p>ENTER POS will be displayed if AN/ASN-149(V) has no position data in memory. If ENTER POS is displayed, line select key 3 must be pressed to return to normal display.</p>	
c.	Set data switch to VAR-DTM.	
d.	Check display line 1. If WP is displayed, press WP key.	
e.	Check map datum on map in use- Look up code for that map datum in Table 3-16. Compare map datum (DTM) code displayed on display line 3 with Table 3-16 map datum code. If displayed DTM code is incorrect, enter correct DTM code display line 3.	
f.	Set data switch to POS.	
	<p><b>NOTE</b></p> <p>When entering MGRS coordinates, do not press line select key 2 after entering zone, and line select key 3 before entering coordinates. MGRS zone and coordinates are entered like a one display line entry.</p>	
	<p><b>NOTE</b></p> <p>Leading zeros must be entered (Example: 91°02'28.3" = 091°02'28.3", 800 = 00800) in steps g. thru i. if required.</p>	
g.	Check latitude/MGRS zone displayed on display line 2. If displayed position and actual position differ by more than 60 miles or 100 kilometers, enter correct position on display line 2.	
h.	Check longitude/MGRS coordinates displayed on display line 3. If displayed position and actual position differ by more than 60 miles or 100 kilometers, enter correct position on display line 3.	

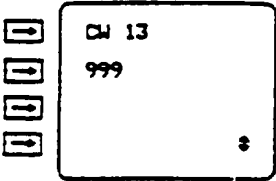
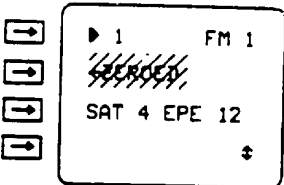
**Table 3-6. AN/ASN-149(V) GPS Start-Up Procedure - (Continued).**

Step	Procedure	Display
i.	Check altitude on display line 4. If displayed altitude and actual altitude differ by more than 656 feet (FT) or 200 meters (M), enter correct altitude on display line 4.	
j.	Set data switch to TRK-GS.	
k.	Press slew key.	
<b>NOTE</b>		
Time is displayed in coordinated universal (Zulu) time (24 hour clock).		
Leading zeros must be entered (Example: 1:09:08 = 01:09-.08) in step l if required. Leading zeros will not be erased when entry is complete.		
l.	Check Zulu time displayed on display line 2. If displayed Zulu time differs from actual Zulu time by more than 1 minute, enter correct Zulu time on display line 2.	
<b>NOTE</b>		
Day of year is Julian date.		
Leading zeros must be entered (example: 3 = 003, 33 - 033) in step m, if required. Leading zeros will not be erased when entry is complete.		
m.	Check year (YR) and day of year (DOY) on display line 4. If YR and DOY and actual YR and DOY differ, enter actual YR and DOY on display line 4.	
n.	Set data select switch to MSN.	
o.	Check display line 3; if *DOP ONLY displayed, press line select key 3.	
p.	Check display line 4; if *GPS ONLY displayed, press line select key 4.	
q.	Press slew key.	

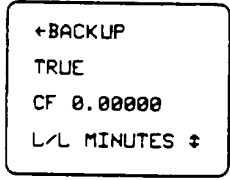
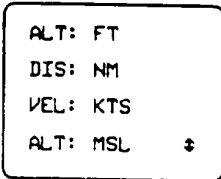
**Table 3-6. AN/ASN-149(V) GPS Start-Up Procedure - (Continued).**

Step	Procedure	Display
r.	Check display line 4; if - BARO is displayed, press line select key 4.	
	<b>NOTE</b>	
	After NAV is selected, time and position initialization inputs cannot be changed.	
s.	Remove data transfer module from data transfer module receptacle if installed.	
	<b>NOTE</b>	
	Complete steps t thru y if AN/ASN-149(V) is to supply time correction information to precise time and time interval (PTTI) equipment. If not, go to step z.	
t.	Rotate data switch to OPT.	
u.	Press slew key until CW is displayed on display line L	
v.	Enter 12 on display line 1.	
	<b>NOTE</b>	
	Leading zeros must be entered (example: 5 = 005, 10 = 010) in steps w and y, if required. Leading zeros will be erased when data entry is complete.	
w.	Check LI path delay on display line 2. If displayed LI path delay and actual LI path delay differ, enter actual LI path delay in nanoseconds on display line 2.	

**Table 3-6. AN/ASN-149V) GPS Start-Up Procedure-(Continued).**

Step	Procedure	Display
x.	Enter 13 on display line 1.	
y.	Check L2 path delay on display line 2. If displayed L2 path delay and actual 12 path delay differ, enter actual L2 path delay in nanoseconds on display line 2.	
<b>NOTE</b>		
<p>After NAV is selected, initialization inputs cannot be changed. If a cold start is required, COLD will alternate with FM on display line 1 while cold start is in progress. Cold start progress may be checked by setting the data switch to STAT and pressing the slew key three times.</p>		
<p>After NAV is selected, FM will be replaced with MEM or DOP until FM 2 or less is displayed.</p>		
z.	Set mode switch to NAV.	
aa.	Set data switch to STAT.	
ab.	<p>Check number of satellite measurements (SAT) being used in the navigation solution and estimated position error (EPE) on display line 3. The AN/ASN-149(V) is ready for operation when four satellite measurements are being used and EPE is less than 25 meters, approximately 2 minutes. If only three satellites are available, the AN/ASN-149(V) may be prepared for use by entering an altitude estimate. Altitude can be entered by setting the data switch to POS and entering the altitude estimate. M will be displayed to left of altitude display indicating that an altitude may be entered. If an altitude has been entered AHLD (altitude hold) will alternate with FM while the entered altitude is being used. M and AHLD will be automatically dropped when four satellites are acquired. Manual altitude hold may be dropped by pressing line select key 4 twice.</p>	

**Table 3-7. Units of Measurement, Coordinate Systems. North Reference, Altitude Reference, and Lever Arm Selection Procedure.**

Step	Procedure	Display
a.	Set mode switch to INIT or NAV.	
b.	Set data switch to OPT.	
c.	Check display line 1. If WP is displayed, press WP key.	
d.	Press line select key 2 to select a desired north reference TRUE, GRID, or MAG (magnetic).	
	<p style="text-align: center;"><b>NOTE</b></p> <p>Convergence factor (CG) is meaningless unless GRID is selected.</p> <p style="text-align: center;"><b>NOTE</b></p> <p>Leading zeros must be entered (example: 0.00098, 0.00100) in step e, if required. Leading zeros will not be erased when entry is complete.</p>	
e.	Check convergence factor (CF) displayed on display line 3. If the displayed convergence factor is different than the convergence factor of the map in use, enter new convergence factor on display line 3.	
f.	<p>Press line select key 4 until the desired coordinate system is displayed on display line 4:</p> <p style="padding-left: 40px;">L/L SECONDS - Latitude/longitude in degrees, minutes, seconds, and tenths of seconds.</p> <p style="padding-left: 40px;">L/L MINUTES - Latitude/longitude in degrees, minutes, and thousandths of minutes.</p> <p style="padding-left: 40px;">MGRS - Military grid reference system.</p>	
g.	Press slew key.	
h.	Press line select key 1 to select FT (feet) or M (meters) for altitude (ALT) and estimated position error (EPE) displays.	

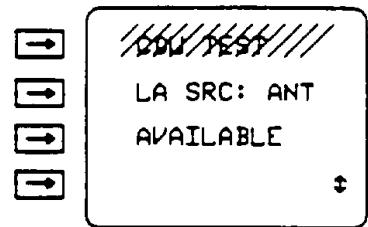
**Table 3-7. Units of Measurement, Coordinate Systems. North Reference, Altitude Reference, and Lever Arm Selection Procedure - (Continued).**

Step	Procedure	Display
i.	Press line select key 2 to select NM (nautical miles) or KM (kilometers) for distance (DIS) displays.	
j.	Press line select key 3 to select KTS (knots) or KPH (kilometers per hour) for speed (VEL) displays.	
k.	Press line select key 4 to select mean sea level (MSL) or map datum (DTM) for altitude reference.	
l.	Press and release slew key until LA SRC: is displayed on display line 2.	
m.	Check lever arm source (LA SRC) on display line 2:	


- ANT - antenna
- CDU - C-11702/UR
- DL - data loader
- HV - aircraft external navigation equipment

**NOTE**

















































The status will change automatically depending on the selection on display line 2.



**Table 3-7. Units of Measurement, Coordinate Systems. North Reference, Altitude Reference, and Lever Ann Selection Procedure - (Continued).**

Step	Procedure	Display
n.	<p>Check status of LA SRC on display line 3:</p> <p>AVAILABLE - Indicates data is available for the LA SRC displayed on display line 2, but is not being currently used.</p> <p>NO DATA - Indicates no data is available for LA SRC displayed on display line 2.</p> <p>USING - Indicates LA SRC displayed on display line 2 is being used for lever arm input data.</p> <p>DEFAULT - Indicates the AN/ASN-149(V) has no LA SRC in memory. The default lever arm data source is the antenna. To select the antenna, press line select key 3. Display line 3 will automatically change from DEFAULT TO USING. If line select key 3 is not pressed, the AN/ASN-149(V) will automatically select the antenna as the LA SRC.</p>	
	<p><b>NOTE</b></p>	
	<p>An LA SRC may be selected only when display line 3 displays AVAILABLE or DEFAULT.</p>	
o.	<p>Select desired LA SRC on display line 2 by pressing line select key 3.</p>	
	<p><b>NOTE</b></p>	
	<p>To check actual lever arm data being used by the AN/ASN-149(V), complete steps p thru v. To enter lever arm enter data using the C-11702/UR, complete steps w thru ab.</p>	
p.	<p>Press and release slew key until CW is displayed on display line 1.</p>	
q.	<p>Enter 08 on display line 1.</p>	

**Table 3-7. Units of Measurement, Coordinate Systems. North Reference, Altitude Reference, and Lever Arm Selection Procedure - (Continued).**

Step	Procedure	Display
r.	Check current up/down (+ = up, - = down) lever arm displayed in meters (M) on display line 2.	    <div style="border: 1px solid black; padding: 5px; width: fit-content;">             CW 8              +100.0  <span style="float: right;">↕</span> </div>
s.	Enter 09 on display line 1.	    <div style="border: 1px solid black; padding: 5px; width: fit-content;">             CW 9              +100.0  <span style="float: right;">↕</span> </div>
t.	Check current fore/aft (+ = fore, - = aft) lever arm displayed in meters (M) on display line 2.	    <div style="border: 1px solid black; padding: 5px; width: fit-content;">             CW 10              +100.0  <span style="float: right;">↕</span> </div>
u.	Enter 10 on display line 1.	    <div style="border: 1px solid black; padding: 5px; width: fit-content;">             CW 10              +100.0  <span style="float: right;">↕</span> </div>
v.	Check current left/right (+ = left, - = right) lever arm in meters (M) displayed on display line 2.	    <div style="border: 1px solid black; padding: 5px; width: fit-content;">             CW 5              +100.0  <span style="float: right;">↕</span> </div>
w.	Enter 05 on display line 1.	    <div style="border: 1px solid black; padding: 5px; width: fit-content;">             CW 6              +100.0  <span style="float: right;">↕</span> </div>
	<p><b>NOTE</b>                      To enter new or correct lever arm source data, complete steps w. thru ab.</p>	    <div style="border: 1px solid black; padding: 5px; width: fit-content;">             CW 7              +100.0  <span style="float: right;">↕</span> </div>
x.	Enter desired up/down (+ = up, - = down) lever arm in meters (M) on display line 2.	    <div style="border: 1px solid black; padding: 5px; width: fit-content;">             CW 6              +100.0  <span style="float: right;">↕</span> </div>
y.	Enter 06 on display line 1.	    <div style="border: 1px solid black; padding: 5px; width: fit-content;">             CW 7              +100.0  <span style="float: right;">↕</span> </div>
z.	Enter desired fore/aft (+ = fore, - = aft) lever arm in meters (M) on display line 2.	    <div style="border: 1px solid black; padding: 5px; width: fit-content;">             CW 7              +100.0  <span style="float: right;">↕</span> </div>
aa.	Enter 07 on display line 1.	    <div style="border: 1px solid black; padding: 5px; width: fit-content;">             CW 7              +100.0  <span style="float: right;">↕</span> </div>
ab.	Enter desired left/right (+ = left, - = right) lever arm in meters (M) on display line 2.	    <div style="border: 1px solid black; padding: 5px; width: fit-content;">             CW 7              +100.0  <span style="float: right;">↕</span> </div>



d. GPS Self-Test. Testing is divided into three parts: automatic built-in test (BIT), command self-test and keyboard/display test. The automatic BIT is done each time the indicator controller is set to INIT, NAV or TEST from OFF. The command self-test is done when the indicator controller mode switch is set to TEST.

The keyboard/display test is done by pressing each of the keys on the indicator controller and checking that each character is displayed correctly. Perform the keyboard/display test only when the keyboard or the data display appears to work incorrectly.

Preliminary Procedures. None

**Table 3-8. Command Self-Test Procedure.**

Step	Procedure	Display
------	-----------	---------

**NOTE**

Be sure aircraft power is applied to AN/ASN-149(V) before starting procedure.

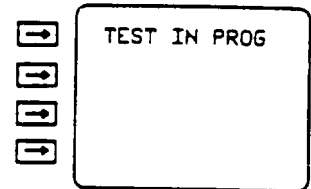
- a. Adjust indicator controller BRT control full clockwise.
- b. Set mode switch to TEST. Mode switch must be pulled out to set to TEST.

**NOTE**

The indicator controller requires a 30-second warm-up before the data display will display data.

**NOTE**

If failure data is displayed instead of TEST IN PROG, notify organizational maintenance.



- c. After 30 seconds, check TEST IN PROG is displayed on display line 1.

**NOTE**

Test may take up to 5 minutes Test progress reports will flash briefly during testing.

- d. Adjust indicator controller BRT control counterclockwise for a comfortable viewing level.

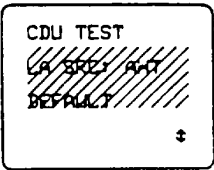
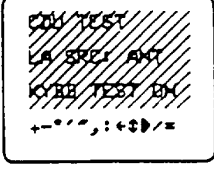
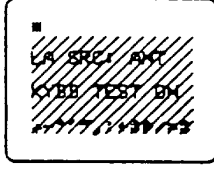
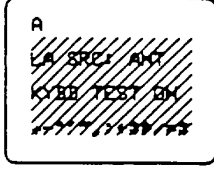
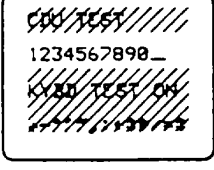
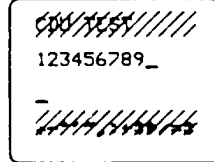
**NOTE**

Indicator controller panel lighting glows green. Light level is very low; shield C-1 1702/UR from any light while checking.

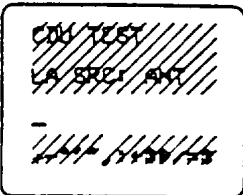
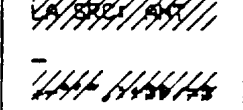
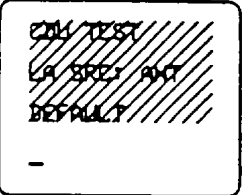
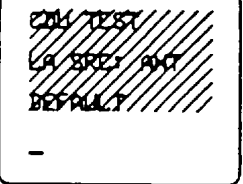
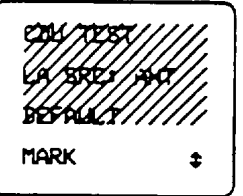
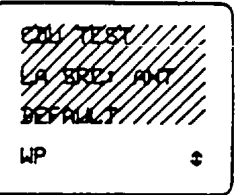
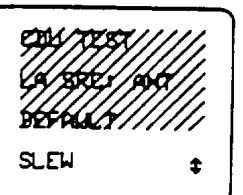

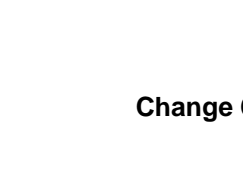
**Table 3-8. Command Self-Test Procedure - (Continued).**

Step	Procedure	Display
e.	Adjust aircraft dimmer control clockwise and counterclockwise while checking indicator controller panel lighting.	Panel light level varies with changing setting of aircraft dimmer control.
f.	Adjust aircraft dimmer control for a comfortable viewing level.	
g.	Check data display. If no failures were detected, display line 1 will display TEST COMPLETE. Display line 2 will display TEST OK- Display line 4 will display CLEAR N/V MENU; this is for maintenance use only. If a failure is detected, H/W FAILURE or a fault code will be displayed on display line 1. Display lines 2 and 3 will display failure codes. Display line 4 may display additional information. Report all failures to organizational maintenance.	<p>The display diagrams show three possible outcomes of a self-test:</p> <ul style="list-style-type: none"> <li><b>Successful Test:</b> Line 1: TEST COMPLETE; Line 2: TEST OK; Line 3: (blank); Line 4: CLEAR N/V MENU.</li> <li><b>Hardware Failure:</b> Line 1: H/W FAILURE; Line 2: RCVR A4; Line 3: 17# 0040; Line 4: (blank).</li> <li><b>External Fault:</b> Line 1: EXT FAULT; Line 2: RCVR A1; Line 3: 41 0000; Line 4: (blank).</li> </ul>
h.	Set mode switch to any position except TEST to end commanded self-test.	

**Table 3-9. Keyboard/Display Test Procedure.**

Step	Procedure	Display
a.	Set mode switch to NAV.	
b.	Set data switch to OPT.	
c.	Check display line 1. If WP is displayed, press WP key.	
d.	Press slew key until CDU TEST is displayed on display line 1.	
e.	Press line select key 1.	
f.	Check symbols +-°O, ‘ “ , : ← ↑ > / = are displayed on display line 4.	
g.	Press line select key 1. Check display line 1 is cleared.	
h.	Press USE/LTR key. Check (*) is displayed on display line 1.	
<p style="text-align: center;"><b>NOTE</b> Letters will blink after entering. This is normal.</p>		
i.	Enter letters A thru Z while checking that letters are displayed on display line 1, in the first character position.	
j.	Press line select key 1.	
k.	Press line select key 2. Check display line 2 is cleared.	
l.	Enter numbers 1 thru 0 while checking 1234567890 are displayed on display line 2.	
m.	Press CLR key and check last number is erased.	
n.	Press line select key 2.	

**Table3-9. Keyboard/Display Test Procedure.**

Step	Procedure	Display
o.	Press line select key 3. Check display line 3 is cleared.	
p.	Press line select key 3.	
q.	Press line select key 4. Check display line 4 is cleared.	
<p style="text-align: center;">NOTE First letter will blink after MARK key is pressed. This is normal.</p>		
r.	Press MARK key and check MARK is displayed on display line 4.	
<p style="text-align: center;">NOTE First letter will blink W then M. This is normal.</p>		
s.	Press WP key and check WP is displayed on display line 4.	
<p style="text-align: center;">NOTE First letter will blink S then W. This is normal.</p>		
t.	Press slew key and check SLEW is displayed on display line 4.	
u.	Set data switch to any position except OPT to end keyboard/display test.	

e. Entering and Checking Waypoints.

A waypoint is the location of a point on the desired course. The AN/ASN-149(V) provides information to perform area navigation (RNAV) operations. The AN/ASN-149 (V) displays data that allows the aircraft to fly from the present position to the next programmed waypoint. The next waypoint is referred to as the current steer-to destination. A normal mission consists of a series of waypoints. During normal operation the aircraft is navigated from the departure point to waypoint 1 (WP1). After arriving at WP1, WP2 is entered as the steer-to destination and the aircraft is navigated to WP2. The aircraft is navigated to consecutive waypoints until reaching the final destination. The location of targets, prominent landmarks, or navigational aids (NAVAID) are usually used to define waypoints. NAVAID include very high frequency omnidirectional radio range (VOR), tactical air navigation (TACAN), and nondirectional beacon (NDB) stations. Another aircraft can also be defined as a moving waypoint. Moving waypoints are normally used in rendezvous (\*REND) operation. The AN/ASN-149(V) can store 209 waypoints in memory. These waypoints are numbered WP1 thru WP209. WP1 thru WP9 may be used as stationary or moving destinations. WP100 thru WP209 may be used with stationary destinations only. Data for moving waypoints may be stored in W10 thru WP209; however, the data must be moved to a WP1 thru WP9 location to be selected as a destination. All waypoints are defined by position (latitude/longitude (L/L) or military grid reference system (MGRS) coordinates) altitude, and map datum (DTM). A ground track (TRK), ground speed (GS), and time of fix (TOF) are also required for moving waypoints.

Waypoints can also be defined by a bearing (BRG), range (RNG), and elevation angle (EL ANG) from some reference point. Present position or a previously defined waypoint are the usual references. Alphanumeric identifier can be stored for all 209 waypoints. If the waypoint identifies a NAVAID, the frequency or channel can be stored. An alphanumeric identifier is required if more than one waypoint will be stored using the same frequency or channel information. Desired track (DTK) vertical angle (VA), and map datum (DTM) to the waypoint may also be stored.

Waypoints can be automatically entered with a data loader using a data transfer module containing the required data. When a data loader capability is available, entering waypoints is accomplished during the start-up procedure (Table 3-6). If the data loader capability is not available, waypoints may be entered using the indicator controller, Table 3-6.

NOTE

Keeping a written record of the waypoint memory numbers, alphanumeric identifiers, and frequency or channel numbers may save time later.

**Table 3-10. Entering Stationary Waypoints via the Indicator Controller**

Step	Procedure	Display
------	-----------	---------

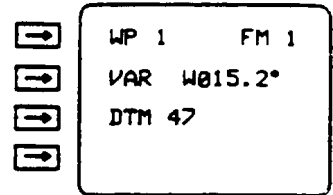
**NOTE**

This procedure can be used for waypoint numbers 1 thru 209. The waypoint must be stationary

- a. Ensure mode switch set to NAV or INIT.
- b. Set data switch to VAR-DTM
- c. Check display line 1. If > is displayed, press WP key.

**NOTE**

If WP entered in step d has been previously defined with an alphanumeric identifier, the alphanumeric identifier will be displayed when the waypoint number is entered.



- d. Enter waypoint (WP) number (1 thru 209) for waypoint to be defined on line 1

**NOTE**

Step e is optional.

**NOTE**

Leading zeros must be entered (example: 1= 00.0, 10- 010.0) in step e, if required. Leading zeros will not be erased when entry is complete.

- e. Enter waypoint magnetic variation (VAR) on display line 2. First character must be E (east) or W (west).
- f. Enter waypoint map datum (DTM) code on display line 3. Map datum codes are listed in Table 3-12

**Table 3-10. Entering Stationary Waypoints via the Indicator Controller - (Continued).**

Step	Procedure	Display
------	-----------	---------

g. Set data switch to POS.

**NOTE**

When entering MGRS coordinates, do not press line select key 2 after entering zone, and line select key 3 before entering coordinates. MGRS zone and coordinates are entered like a one display line entry.

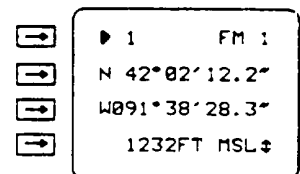
**NOTE**

Leading zeros must be entered (example: 91 02'28.3" = 091 02'28.3", 800 =00800) in steps h thru j, if required.

h. Enter waypoint latitude or MGRS grid zone on display line 2.

i. Enter waypoint longitude or MGRS coordinates on display line 3.

j. Enter waypoint altitude on display line 4.



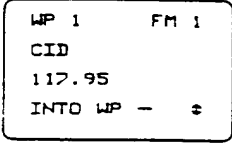
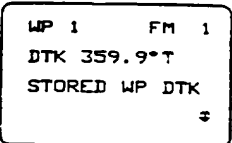
**NOTE**

Steps k thru m are optional. A waypoint may be identified by entering an alphanumeric identifier (step 1) and/or a NAVAID frequency (step m) in addition to the waypoint number (step d).

**NOTE**

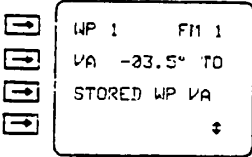
If an alphanumeric identifier is selected and the data switch is set to another position, the WP display will indicate the alphanumeric identifier and the waypoint number will not be displayed. If an alphanumeric identifier is not selected, the waypoint number will be displayed.

**Table 3-10. Entering Stationary Waypoints via the Indicator Controller - (Continued)**

Step	Procedure	Display
k.	Press slew key	
l.	Enter waypoint alphanumeric identifier on display line 2. Alphanumeric identifier can be a maximum of six characters.	
m.	Enter NAVAID frequency or channel on display line 3. Allowable NAVAID frequencies are:  VOR - 108.00 to 117.99 TACAN - IX to 126X and IY to 126Y. NDB - 1 to 9999 Decimal point must be entered for VOR or NDB frequencies.	
	NOTE	
	To transfer waypoint description into WP 1 thru 9, enter applicable waypoint (WP) number on display line 4.	
	NOTE	
	Steps n thru q are optional.	
n.	Set data switch to DTK-VA	
	NOTE	
	Leading zeros must be entered (example: 5 = 000.5, 50 = 050.0) in step o, if required. leading zeros will not be erased when entry is complete.	
o.	Enter desired track (DTK) to waypoint as referenced to true (1), grid (G), or magnetic (M) north on display line 2.	
	NOTE	
	Display line 3 displays STORED WP DTK to remind operator that DTK displayed is entered for waypoint number displayed on display line 1.	



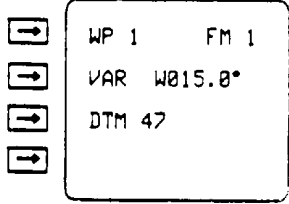
**Table 3-10. Entering Stationary Waypoints via the Indicator Controller - (Continued)**

Step	Procedure	Display
p.	Press slew key.	
	<p><b>NOTE</b>                      Leading zeros must be entered (example: .5 = 00.5, 2 = 02.0) in step q, if required. Leading zeros will not be erased when entry is complete.</p>	
q.	Enter vertical angle (VA) from present position to waypoint on display line 2.	
	<p><b>NOTE</b>                      Display line 3 displays STORED WP VA to remind operator that VA displayed is entered for waypoint number displayed on display line 1.</p>	

**Table 3-11. Entering Moving Waypoints via the Indicator Controller.**

Step	Procedure	Display
	<p><b>NOTE</b>                      The displayed position coordinates of a moving waypoint will not change unless it is selected as the destination in rendezvous (*REND) operation.</p>	
a.	Ensure mode switch set to NAV or INIT.	
b.	Set data switch to VAR-DTM.	
c.	Check display line 1. If > is displayed, press WP key	

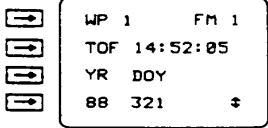
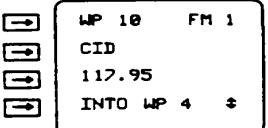
**Table 3-11. Entering Moving Waypoints via the Indicator Controller (Continued).**

Step	Procedure	Display
d.	Enter waypoint (WP) number for waypoint to be defined on display line 1	
	<p>NOTE Step e. is optional</p>	
	<p>NOTE Leading zeros must be entered (example: 1 = 001.0, 10 = 010.0) in step e, if required. Leading zeros will not be erased when entry is complete</p>	
e.	Enter waypoint magnetic variation (VAR) on display line	
2.	First character must be E (east) or W (west)	
f.	Enter waypoint map datum (DTM) code on display line 3. Map datum codes are listed in Appendix E. If datum code is 20, complete paragraph 2-27 before going to step g	
g.	Set data switch to POS	
	<p>NOTE When entering MGRS coordinates, do not press line select key 2 after entering zone and line select key 3 before entering coordinates. MGRS zone, and coordinates are entered like a one display line entry</p>	
	<p>NOTE Leading zeros must be entered (example: 91 02"28.3" = 091 °02"28.3", 800 in steps h. thru j. if required</p>	
h.	Enter waypoint initial latitude or MGRS grid zone on display line 2	

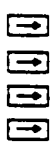

**Table 3-11. Entering Moving Waypoints via the Indicator Controller (Continued)**

Step	Procedure	Display
i.	Enter waypoint initial longitude or MGRS coordinates on display line 3	
j.	Enter waypoint initial altitude on display line 4	
NOTE		
<p>Steps k. thru m. are optional. A waypoint may be identified by entering an alphanumeric identifier (step 1) and/or a NAVAID frequency (step m.) in addition to the waypoint number (step d.)</p>		
NOTE		
<p>If an alphanumeric identifier is selected and the data switch is set to another position, the WP display will indicate the alphanumeric identifier and the waypoint number will not be displayed                      If an alphanumeric identifier is not selected, the waypoint number will remain displayed</p>		
k.	Press slew key	
l.	Enter moving waypoint alphanumeric identifier on display line 2. Alphanumeric identifier can be a maximum of six characters	

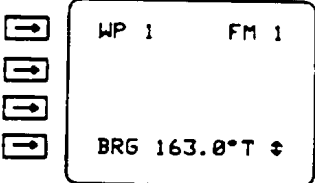
**Table 3-11. Entering Moving Waypoints via the Indicator Controller (Continued)**

Step	Procedure	Display
m.	<p>Enter NAVAID frequency or channel on display line 3.                      Allowable NAVAID frequencies are:</p> <p>VOR- 108.00 to 117.99                      TACAN -IX to 126X and 1Y to 126Y                      NDB - 1. to 9999Decimal point must be entered for VOR or NDB frequencies</p>	
n.	<p>Set data switch to TRK-GS</p> <p style="text-align: center;">NOTE</p> <p style="text-align: center;">Leading zeros must be entered (example: 0.1 = 000.1, 1=001.0) in step o, if required. Leading zeros will not be erased when entry is complete</p>	
o.	<p>Enter moving waypoint track (TRK) referenced to true (T), grid (G), or magnetic (M) north on display line 2</p> <p style="text-align: center;">NOTE</p> <p style="text-align: center;">Leading zeros must be entered (example: 10 = 0010, 100 = 0100) in step p, if required. Leading zeros will be erased when entry is complete</p>	
p.	<p>Enter moving waypoint ground speed (GS) in knots (KTS) or kilometers per hour (KPH) on display line 3</p> <p style="text-align: center;">NOTE</p> <p style="text-align: center;">Time of fix (TOF) is the time at which the waypoint was at the position coordinates, altitude, TRK, and GS just entered;</p> <p style="text-align: center;">or</p> <p style="text-align: center;">The starting time for the waypoint to begin moving</p>	

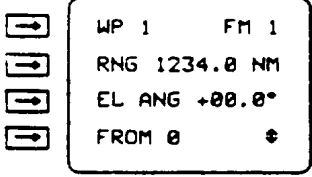
**Table 3-11. Entering Moving Waypoints via the Indicator Controller - (Continued)**

Step	Procedure	Display								
q.	Press slew key									
	NOTE									
	Leading zeros must be entered (example: 1:09:08 = 01:09:08) in step r, if required. Leading zeros will not be erased when entry is complete									
r.	Enter time of fix (TOF) of moving waypoint on display line 2									
	NOTE									
	Leading zeros must be entered (example: 3 = 003, 33=033) in step s if required. Leading zeros will not be erased when entry is complete									
		 <table border="1" style="border-collapse: collapse; width: 100%;"> <tr> <td style="padding: 2px;">WP 1</td> <td style="padding: 2px;">FM 1</td> </tr> <tr> <td style="padding: 2px;">TOF 14:52:05</td> <td></td> </tr> <tr> <td style="padding: 2px;">YR DOY</td> <td></td> </tr> <tr> <td style="padding: 2px;">88 321</td> <td style="padding: 2px;">↕</td> </tr> </table>	WP 1	FM 1	TOF 14:52:05		YR DOY		88 321	↕
WP 1	FM 1									
TOF 14:52:05										
YR DOY										
88 321	↕									
s.	Enter year (YR) and Julianne date (day of year) (DOY) on display line 4									
	NOTE									
	Complete steps t thru w to move data to waypoints 1 thru 9 if necessary									
t.	Set data switch to POS									
u.	Check display line 1. If I> is displayed, press WP key									
v.	Press slew key									
w.	Enter waypoint number on display line 4 where waypoint data is to be moved									
		 <table border="1" style="border-collapse: collapse; width: 100%;"> <tr> <td style="padding: 2px;">WP 10</td> <td style="padding: 2px;">FM 1</td> </tr> <tr> <td style="padding: 2px;">CID</td> <td></td> </tr> <tr> <td style="padding: 2px;">117.95</td> <td></td> </tr> <tr> <td style="padding: 2px;">INTO WP 4</td> <td style="padding: 2px;">↕</td> </tr> </table>	WP 10	FM 1	CID		117.95		INTO WP 4	↕
WP 10	FM 1									
CID										
117.95										
INTO WP 4	↕									

**Table 3-12. Entering Waypoints by Bearing, Range and Elevation Angle Procedure**

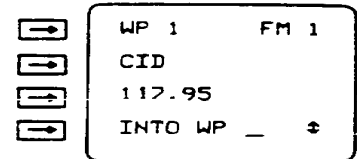
Step	Procedure	Display
a.	Ensure mode switch set to NAV or INIT	
b.	Set data switch to POS	
c.	Check display line 1 If > is selected, press WP key	
d.	Enter waypoint (WP) number (1 thru 209) for waypoint to be defined on display line 1	
e.	Set data switch to DIS-TG	
	<p>NOTE</p> <p>After BRG has been entered, data display will automatically change to enter range (RNG). Do not press slew key</p>	
	<p>NOTE</p> <p>Leading zeros must be entered (Example: .5 = 000.5, 10 = 0010) in step f and g, if required. Leading zeros will not be erased when entry is complete</p>	
f.	Enter bearing (BRG) to waypoint referenced to true (T), grid (G), or magnetic (M) north on display line 4	
	<p>NOTE</p> <p>If no range is entered, AN/ASN-149(V) will assume range of zero</p>	

**Table 3-12. Entering Waypoints by Bearing, Range and Elevation Angle Procedure - (Continued)**

Step	Procedure	Display
g.	Enter range (RNG) in kilometers (KM) or nautical miles (NM) on display line 2	
	<p style="text-align: center;">NOTE</p> A negative elevation angle means the waypoint is lower than reference point. If no elevation angle is entered, the range in step g is a great circle distance and the AN/ASN-149(V) will assume waypoint is at same altitude as reference point	
	<p style="text-align: center;">NOTE</p> Leading zeros must be entered (Example: 1 = 00.1, 1 = 01) in step h, if required. Leading zeros will not be erased when entry is complete	
h.	Enter elevation angle (EL ANG) on display line 3	
	<p style="text-align: center;">NOTE</p> If no reference waypoint number or identifier is entered, AN/ASN-149(V) will assume reference is present position and will display dashes (-)	
i.	Enter reference waypoint number or alphanumeric identifier on display line 4	
	<p style="text-align: center;">NOTE</p> Waypoint position will not be computed until step j. is performed. If present position is being used as reference and aircraft has moved since bearing, range, and elevation angle were determined, waypoint position will be incorrect	

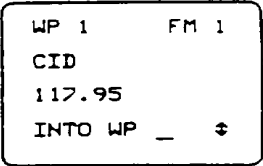
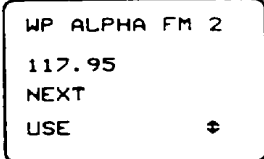
**Table 3-12. Entering Waypoints by Bearing, Range and Elevation Angle Procedure - (Continued)**

Step	Procedure	Display
j.	Press slew key to return to normal DIS-TG display	
	NOTE	
	Steps k. thru n. are optional. A waypoint may be identified by entering an alphanumeric identifier (step m.) and/or a NAVAID frequency (step n.) in addition to the waypoint number (step d.)	
	NOTE	
	If an alphanumeric identifier is selected and the data switch is set to another position, the WP display will indicate the alphanumeric identifier and the waypoint number will be erased. If an alphanumeric identifier is not selected, the waypoint number will be displayed	
k.	Set data switch to POS	
l.	Press slew key	
m.	Enter waypoint alphanumeric identifier on display line 2. Alphanumeric identifier can be a maximum of six characters	
n.	Enter NAVAID frequency or channel on display line 3. Allowable NAVAID frequencies are:	
	VOR- 108.00to 117.99 TACAN - 1X to 126X and 1Y to 126Y NDB - 1. to 9999Decimal point must be entered for VOR or NDB frequencies	
	NOTE	
	To transfer waypoint description into WP 1 thru 9, enter applicable waypoint (WP) number on display line 4	














**Table 3-13. Checking Waypoints Procedure**

Step	Procedure	Display
a.	Ensure mode switch set to NAV or INIT	
b.	Set data switch to POS	
c.	Check display line 1. If is displayed, press WP key	
	<p style="text-align: center;">NOTE</p> <p>More than one waypoint may be defined using the same NAVAID frequency or channel. The first waypoint displayed is the closest to present position. The next waypoint or waypoints are displayed in the order entered. Verify alphanumeric identifier is the correct choice before selecting waypoint for checking</p>	
d.	Enter waypoint (WP) number, alphanumeric identifier, or NAVAID frequency or channel on display line 1	
	<p style="text-align: center;">NOTE</p> <p>Allowable NAVAID frequencies are:  VOR- 10800 to 117.99  TACAN - IX to 126X and 1Y to 126Y  NDB - 1. to 9999.  Decimal point must be entered for VOR or NDB frequencies</p> <p>If multiple waypoints were entered that have the same NAVAID frequency or channel go to step e; if not, go to step F</p>	
e.	<p>Check waypoint (WP) identifier displayed on display line 1</p> <ol style="list-style-type: none"> <li>1. If incorrect, press line select key 3 (NEXT) for next waypoint with the same frequency or channel</li> <li>2. If correct, press line select key 4 (USE) to return to normal display</li> </ol>	

**Table 3-13. Checking Waypoints Procedure (Continued)**

Step	Procedure	Display
f.	Check waypoint position coordinates and altitude on display lines 2, 3, and 4	 <div style="border: 1px solid black; padding: 5px; width: fit-content;"> <p>▶ 1      FM 1</p> <p>N 42°02'12.2"</p> <p>W091°38'28.3"</p> <p>1232FT MSL↕</p> </div>
g.	Press slew key	
h.	Check waypoint number on display line 1, alphanumeric identifier on display line 2, and NAVAID frequency or channel on display line 3	 <div style="border: 1px solid black; padding: 5px; width: fit-content;"> <p>WP 1      FM 1</p> <p>CID</p> <p>117.95</p> <p>INTO WP _ ↕</p> </div>
	<p>NOTE</p> <p>Entering a number (1-9) on display line 4 causes the waypoint being checked to be transferred into the WP number selected</p>	
i.	Set data switch to VAR-DTM	
j.	Check magnetic variation (VAR) on display line 2 and map datum (DTM) code on display line 3. If no magnetic variation is stored display line 2 will display dashes	 <div style="border: 1px solid black; padding: 5px; width: fit-content;"> <p>WP 1      FM 1</p> <p>VAR W015.0°</p> <p>DTM 47</p> </div>
k.	Set data switch to DIS-TG	
l.	Check great circle distance (DIS) to waypoint on display line 2, time to go (TG) to waypoint in days; hours, minutes, and seconds on display line 3; and bearing (BRG) to waypoint on display line 4	 <div style="border: 1px solid black; padding: 5px; width: fit-content;"> <p>WP 1      FM 1</p> <p>DIS 125.4 NM</p> <p>TG 2 05:23:17</p> <p>BRG 147.2°T ↕</p> </div>
m.	Press slew key	
n.	Check slant range (RNG) to waypoint on display line 2	
o.	Set data switch to TRK-GS	
p.	Check ground track (TRK) on display line 2 and ground speed (GS) for the moving waypoint (*REND operation only) on display line 3	 <div style="border: 1px solid black; padding: 5px; width: fit-content;"> <p>WP 1      FM 1</p> <p>RNG 124.23NM</p> <p>↕</p> </div>
		 <div style="border: 1px solid black; padding: 5px; width: fit-content;"> <p>WP 1      FM 1</p> <p>TRK 359.9°T</p> <p>GS 265.8 KTS</p> <p>TIME NEXT PG↕</p> </div>

**Table 3-13. Checking Waypoints Procedure - (Continued)**

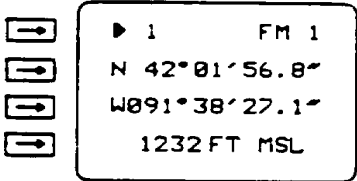
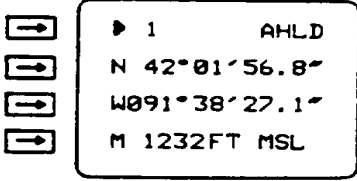
Step	Procedure	Display
q.	Press slew key	
r.	Check starting time of fix (TOF) for moving waypoint (*REND operation only) on display line 2 and year (YR) and day of year (DOY) for the starting time on display line 4. Line 3 always displays YR and DOY as label references for line 4	 <div style="border: 1px solid black; padding: 5px; width: fit-content;"> <p>WP 1      FM 1</p> <p>TOF 23:59:59</p> <p>YR DOY</p> <p>88 321      ‡</p> </div>
s.	Set data switch to DTK-VA	
t.	Check desired track (DTK) to rendezvous with moving waypoint (*REND operation only) or desired track (DTK) stored with stationary waypoint on display line 2. If no (DTK) is stored, display line 2 will display dashes	 <div style="border: 1px solid black; padding: 5px; width: fit-content;"> <p>WP 1      FM 1</p> <p>DTK 359.9°T</p> <p>STORED WP DTK</p> <p>‡</p> </div>
u.	Press slew key	
v.	Check vertical angle (VA) to moving waypoint (*REND operation only) or vertical angle stored with stationary waypoint on display line 2. If no VA is stored, display line 2 will display dashes (-)	 <div style="border: 1px solid black; padding: 5px; width: fit-content;"> <p>WP 1      FM 1</p> <p>VA -03.5° TD</p> <p>STORED WP VA</p> <p>‡</p> </div>

f. Displaying Present Position.

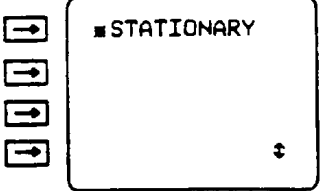
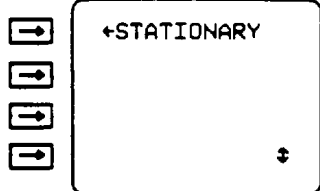
Present position latitude, longitude or military grid reference system (MGRS) coordinates, and altitude may

be displayed at any time after start-up is completed This data is available while the aircraft is moving or stationary. To display present position perform the procedure in Table 3-14

**Table 3-14. Displaying Present Position**

Step	Procedure	Display
a.	Set mode switch to NAV	
b.	Set data switch to POS	
c.	Check display line 1. If WP is displayed, press WP key	
d.	Read present position:	
	Display line 2 - Latitude or MGRS zone Display line 3 - Longitude or MGRS coordinates Display line 4 - Altitude in feet (FT) or meters (M), referenced to mean sea level (MSL) or datum (DTM)	
	NOTE	
	Present position is calculated from the antenna position, or at the point designated by the lever arm. This position may differ from expected present position	
	NOTE	
	If the figure of merit is high and AN/ASN-149(V) is tracking fewer than four satellites, accuracy may be improved by entering a manual altitude hold. Manual altitude hold can be entered any time M is displayed on display line 4	
e.	If manual altitude hold is desired, enter present altitude estimate on display line 4. M will continue to be displayed and AHLD will alternate with FM	
	NOTE	
	AN/ASN-149(V) will automatically drop manual altitude hold if four satellites are received	
	NOTE	
	The position display is more accurate when *STATIONARY operation is selected. The aircraft must be stationary when *STATIONARY operation is selected. Complete steps f thru h for *STATIONARY operation	

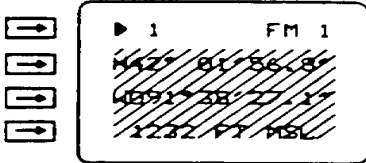
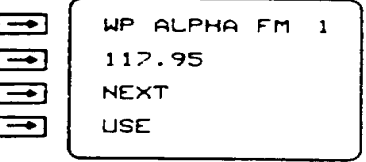
**Table 3-14. Displaying Present Position - (Continued)**

Step	Procedure	Display
f.	Set data switch to OPT	
g.	Press and release slew key until STATIONARY is displayed on display 1	
h.	Check display line 1, if -STATIONARY displayed press line select key 1. Set data switch to POS	
j.	Repeat steps d thru e	
<p><b>NOTE</b> To return to moving operation (-STATIONARY) complete steps k. thru m.</p>		
k.	Set data switch to OPT	
l.	Press and release slew key until *STATIONARY is displayed on display line 1	
m.	Press line select key 1.	

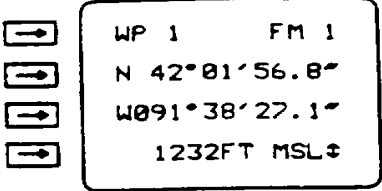
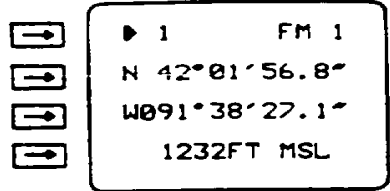
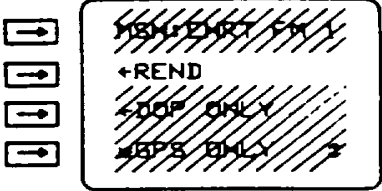
g. Area Navigation (RNAV). The GPS can display information needed to navigate from present position to any mark or waypoint whether stationary or moving, that is selected as the destination. Horizontal information (bearing, great circle distance time to go to destination and slant range distance) can be displayed for all waypoints as well as the selected NAVAID frequency or channel and alphanumeric station identifier. To use the GPS efficiently, it is necessary to understand the basic definitions of area navigation (RNAV).

h. Features. A desired track may be defined and stored with each waypoint entry. When a waypoint is selected as the destination, the desired course is computed by the GPS based on the desired track information. The operator may enter a desired track when an approach to the destination is required from a specific direction. When the destination waypoint is passed, the desired course will be maintained on the outboard radial. The GPS does not automatically advance to the next waypoint when the selected one has been reached: the operator must manually select the next waypoint



**Table 3-15. Area Navigation (RNAV)**

Step	Procedure	Display
a.	Set mode switch to NAV	
b.	Set data switch to POS	
c.	Check display line 1. If >↑s displayed, press the WP key	
	<p><b>NOTE</b> Steer-to destination is the next waypoint you want to steer to. It may not be the final destination of the mission</p>	
d.	<p>Check display line 1. If waypoint (WP) number, alphanumeric identifier, NAVAID frequency or channel displayed is the next steer-to destination, go to step g. If waypoint (WP) number alphanumeric identifier, NAVAID frequency or channel displayed is not the next steer-to destination, go to step e</p>	
	<p><b>NOTE</b> Multiple waypoints may be defined using the same NAVAID frequency or channel. The first waypoint displayed is the closest to present position. The next waypoint or waypoints are displayed in the order entered. Verify alphanumeric identifier is the correct choice before selecting waypoint for use</p>	
e.	<p>Enter waypoint (WP) number, alphanumeric identifier, NAVAID frequency or channel of steer-to destination on display line 1. If multiple waypoints were entered that have the same NAVAID frequency or channel go to step f. if not, go to step g</p>	

**Table 3-15. Area Navigation (RNAV) - Continued**

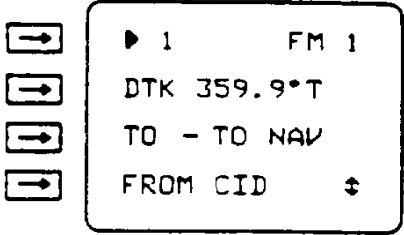
Step	Procedure	Display
f.	<p>Check alphanumeric identifier displayed on display line 1</p> <p>1. If incorrect press line select key 3 (NEXT) for waypoint with the same frequency or channel</p> <p>2. If correct, press line select key 4 (USE) to return to normal display</p>	
g.	<p>Check waypoint position coordinates and altitude to be sure that the correct waypoint is displayed</p>	
h.	<p>Press WP key. The &gt; will be displayed on display line 1; present position coordinates and altitude will be displayed on display lines 2, 3, and 4</p>	
	<p style="text-align: center;">NOTE</p> <p>GPS will continue to compute RNAV data to the previously selected waypoint until the next waypoint number entry is completed by pressing line select key 1</p>	
i.	<p>Check steer-to destination number on display line 1. If not correct, enter correct steer-to destination number on display line 1</p>	
j.	<p>Set data switch to MSN</p>	
k.	<p>Check mission profile. If waypoint is not moving, RNAV mission profile should be selected (- REND displayed). If waypoint is moving, rendezvous mission profile should be selected (- REND displayed). Press line select key 2 until correct profile is displayed on display line 2</p>	
	<p style="text-align: center;">NOTE</p> <p>If NO REND DATA is displayed, some data for a moving waypoint is missing. See paragraph 2-17</p>	
l.	<p>Set data switch to DIS-TG</p>	

**Table 3-15. Area Navigation (RNAV)- Continued**



Step	Procedure	Display
m.	Read great circle distance (DIS) in nautical miles (NM) or kilometers (KM) to destination on display line 2  NOTE Time to go (TG) is invalid unless your aircraft is moving	 <div style="border: 1px solid black; padding: 5px; width: fit-content;"> <p>▶ 1            FM 1</p> <p>DIS 129.8 NM</p> <p>TG 2 12:23:34</p> <p>BRG 359.9° T ↕</p> </div>
n.	Read time to go (TG) on display line 3	
o.	Read bearing (BRG) to destination referenced to true (T), grid (G), or magnetic (M) north on display line 4	
p.	Press slew key	
q.	Read slant range (RNG) in nautical miles (NM) or kilometers (KM) to destination on display line 2	 <div style="border: 1px solid black; padding: 5px; width: fit-content;"> <p>▶ 1            FM 1</p> <p>RNG 128.3 NM</p> <p style="text-align: right;">↕</p> </div>
r.	Set data switch to DTK-VA  NOTE If NO DEST or DEST MOVING is displayed on display line 2, the GPS will not accept a source of DTK or DTK entry	
	NOTE  Each time a new waypoint is selected as the new destination, verify that the correct DTK is being used	



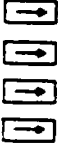
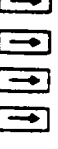
**Table 3-15. Area Navigation (RNAV) - Continued**

Step	Procedure	Display
s.	<p>Select source of desired track (DTK) by pressing line select key 3. Sources are:</p> <p><b>USING OE DTK</b> - Using operator-entered DTK.                      If selected and there is no operator-entered DTK, display line 2 will display dashes (- -). A DTK may be entered by completing step u on display line 2. A DTK may be cleared by pressing line select key 2 twice. Display line 3 will automatically display USING OE DTK if an entry has been made on display line 2</p> <p><b>USING WP DTK</b> - Using the DTK entered during waypoint entering (Table 3-10). If DTK was not entered, display line 2 will display dashes (- -)</p> <p><b>TO-TO NAV</b> - Using FROM waypoint entered on display line 4 as the destination to define a great circle path as the desired course. If no valid FROM waypoint is entered (by completing step t), display lines 2 and 4 will display dashes (- -). Display line 3 will automatically display TO-TO NAV if a valid FROM waypoint has been entered on display line 4</p> <p><b>DIRECT-TO</b> - Using present position to destination great circle desired track. Gives desired track (DTK) defined by the great circle path from the present position to the destination</p>	
	<p style="text-align: center;"><b>NOTE</b></p> <p style="text-align: center;">Complete step t. if TO-TO NAV was selected on display line 3</p>	
t.	<p>Enter waypoint (WP) number or alphanumeric identifier (that was entered with the desired waypoint) on display line 4</p> <p style="text-align: center;"><b>NOTE</b></p> <p style="text-align: center;">Complete step u if USING OE DTK was selected on display line 3</p>	

**Table 3-15. Area Navigation (RNAV) - Continued**

Step	Procedure	Display
u.	Enter desired track (DTK) on display line 2	 <div data-bbox="1154 239 1446 422" style="border: 1px solid black; padding: 5px; display: inline-block;"> <p>▶ 1      FM 1</p> <p>DTK 359.9°T</p> <p><del>PP DEST 50</del></p> <p>FROM -----&gt;</p> </div>
v.	Read desired track (DTK) on display line 2	
w.	Press slew key	
<p><b>NOTE</b> If NO DEST is displayed on display line 3, the GPS will not accept a VA entry</p>		
x.	<p>Select source of vertical angle (VA) by pressing line select key 3. Sources of VA are:</p> <p><b>USING OE VA</b> - Using operator entered VA. If selected and there is no operator entered VA, display line 2 will display dashes (- -). A VA may be entered by completing step y on display line 2. A VA may be cleared by pressing line select key 2 twice. Display line 3 will automatically display USING OE VA if an entry has been made on display line 2</p> <p><b>USING WP VA</b> - Using the VA entered during waypoint entering (Table 3-10). If VA was not entered, display line 2 will display dashes (- -)</p> <p><b>NO VA USED</b> - No VA computation made or desired. If VA is not desired go to step aa</p>	
<p><b>NOTE</b> Complete step y if USING OE VA was selected on display line 3. If not go to step aa</p>		
y.	Enter vertical angle (VA) on display line 2	
z.	Read vertical angle (VA) on display line 2	
aa.	Set data switch to ERR	 <div data-bbox="1154 1272 1446 1455" style="border: 1px solid black; padding: 5px; display: inline-block;"> <p>WP 1      FM 1</p> <p>VA -03.0° TO</p> <p><del>USING OE VA</del></p> </div>
ab.	<p>Read crosstrack error (XTK) left (L) or right (R) of desired course in nautical miles (NM) or kilometers (KM) on display line 2</p>	

**Table 3-15. Area Navigation (RNAV) - Continued**

Step	Procedure	Display
ac.	Read track angle error (TKE) in degrees left (L) or right (R) of desired track on display line 3	 <div style="border: 1px solid black; padding: 5px; width: fit-content;"> <p>▶ 1            FM 1</p> <p>XTK R 4.823NM</p> <p>TKE L 12.6°</p> <p>VE +129 FT</p> </div>
ad.	Read vertical error (VE) in meters (M) or feet (FT) above (+) or below (-) desired vertical angle (VA) on display line 4	
ae.	Set data switch to TRK-GS	
af.	Read present ground track (TRK) referenced to true (T), grid (G), or magnetic (M) north on display line 2	 <div style="border: 1px solid black; padding: 5px; width: fit-content;"> <p>▶ 1            FM 1</p> <p>TRK 359.9°T</p> <p>GS 123.9 KTS</p> <p>TIME NEXT PG⚡</p> </div>
ag.	Read present ground speed (GS) in knots (KTS) or kilometers per hour (KPH) on display line 3	

**Table 3-16. Map Datum Codes.**

Map datum	Data Code
ADINDAN	01
ARC 1950	02
AUSTRALIAN GEODETIC 1966	03
BUKIT RIMPAH	04
CAMP AREA ASTRO	05
DJAKARTA	06
EUROPEAN 1950	07
GEODETIC DATUM 1949	08
GHANA	09
GUAM 1963	10
G. SEGARA	11
G. SERINDUNG	12
HERAT NORTH	13
IJORSEY 1955	14
HU-TZU-SHAN	15
INDIAN	16
IRELAND 1965	17
KERTAU (MALAYAN REVISED TRIANGULATION)	18
LIBERIA 1964	19
USER ENTERED	20
LUZON	21

*Table 3-16. Map Datum Codes - (Continued).*

Map datum	Data Code
MERCHICH	22
MONTJONG LOWE	23
NIGERIA (MINNA)	24
NORTH-AMERICAN-1927:	
CONUS	25
ALASKA AND CANADA	26
OLD HAWAIIAN:	
MAUI	27
OAHU	28
KAUAI	29
ORDINANCE SURVEY OF GREAT BRITAIN 1936	30
QORNOQ	31
SIERRA LEONE 1960	32
SOUTH AMERICA:	
PROVISIONAL SOUTH AMERICAN 1956	33
CORREGO ALEGRE	34
CAMPO INCHAUSPE	35
CHUA ASTRO	36
YACARE	37
TANANARIVE OBSERVATORY 1925	38
TIMBALAI	39
TOKYO	40
VOIROL	41
SPECIAL DATUMS(SD) MGRS RELATED	
SD, INDIAN SPECIAL	42
SD, LUZON SPECIAL	43
SD, TOKYO SPECIAL	44
SD, WGS-84 SPECIAL	45
WGS-72	46
WGS-84 (Default map datum))	47

**3-66. GPS Data Loader Receptacle. (fig. 3-18)**

The GPS data loader receptacle allows the operator to load pre-programmed navigation information into the GPS receiver. This navigational information, such as way point position, DTM or almanac data is pre-loaded on a data loader module, part number 164191-01-02 or 164191-03-01, if Unit Operations and mission dictates.

**3-67. Controls and Function - GPS Data Loader Receptacle.**

Controls of the GPS Data Loader Receptacle are as follows:

CONTROLS/ INDICATOR	FUNCTION
RELEASE Pushbutton	When pressed, releases Data Loader Module from Data Loader Receptacle.

**3-68. Normal Operation - GPS Data Loader Receptacle.**

Perform the following steps in sequence to operate the data loader system:

- a. Turn on the GPS System. Allow system to warm up and time in for approximately one minute.

**Note**

Loading data loader must be done in INIT Mode.

- b. Insert data loader module into data loader receptacle. Wait at least 30 seconds before switching to another mode. Display momentarily flashes when information has been successfully transferred.

- c. Locate module release button on left side of data loader receptacle. Release and remove data loader module from data loader receptacle.

- d. Verify operation of data loader system by:

- (1) Turn GPS Data Select switch to POS.
- (2) Select a way point that is known to be pre-programmed.
- (3) Compare data displayed with known programmed data.
- (4) If other selections are to be checked,

rotate Data Select switch to position desired. Then compare data displayed with the known programmed data.

- (5) Repeat steps (1) thru (5) as desired for any or all remaining way points.

- (6) GPS should now be ready for use during flight operations.

**3-69. GPS KYK-13 Remote Fill Panel. (fig. 3-18)**

The GPS KYK-13 Remote Fill Panel allows encryption data to be loaded from a KYK-13 or KOI-18 fill device. Reference will only be made to the KYK-13.

**3-70. Controls and Function - GPS KYK-13 Remote Fill Panel. (fig. 3-18)**

Controls of the GPS KYK-13 Remote Fill Panel are as follows:

CONTROLS/ INDICATOR	FUNCTION
LOAD STATUS LED INIT	Provides positive indication that GPS receiver has successfully received crypto key fill.
LOAD switch	When pressed, causes the transfer of crypto key from fill device (KYK-13 or KOI-18) to GPS receiver.

**3-71. Normal Operation - GPS KYK-13 Remote Fill Panel.**

To load keys from KYK-13 into the GPS receiver:

**Note**

The GPS receiver does not need to be on to load keys with the KYK-13 Fill Device.

- a. Connect KYK-13. either directly or using a fill cable, to KYK/GPS FILL JI receptacle located on the Remote Fill Panel (Figure 3-18).
- b. Turn KYK-13 Fill switch to desired position.
- c. Turn KYK-13 Mode switch to ON.
- d. Press LOAD IN!T switch on the Remote Fill Panel (Figure 3-18). Wait approximately 5 seconds. If key was successfully loaded, Load Indicator light on the Remote Fill Panel will flash.
- e. Repeat steps b. thru d. to load additional keys.

- f. Turn KYK-13 Mode switch to OFF.
- g. Disconnect KYK-13 from aircraft receptacle.

**3-72. GPS Zeroize Switch.** (fig. 2-9)

The GPS Zeroize switch is located on center instrument panel, right side of AN/APR-39AV(1) Indicator, and is used to erase any crypto data and all navigational information stored in the GPS Receiver.

This zeroize switch consists of a guarded toggle switch.

**3-73. Normal Operation - GPS Zeroize Switch.**

**Note**

Aircraft battery must be connected, or power applied to aircraft.

a. Lift protective guard from zeroize toggle switch and activate switch.

b. If GPS receiver is on, turn Data Switch to Stat. Observe message on Page 1, Line 2.

The message ZEROED indicates a successful attempt to erase information stored in the GPS receiver.

The message ZERO FAIL indicates an unsuccessful attempt to erase the information. The GPS receiver remains classified.

c. An alternate method to zeroize the GPS receiver is to use the C-11702/UR and GPS Control Unit keyboard as follows:

- (1) Select STAT page 1.
- (2) Enter ZZ on line 4, and push Line Select Key 4.
- (3) If ZEROIZED message is displayed on Stat Page 1, Line 2, the GPS receiver is declassified.
- (4) If ZERO FAIL message is displayed, zeroization was not successful and the GPS receiver remains classified.

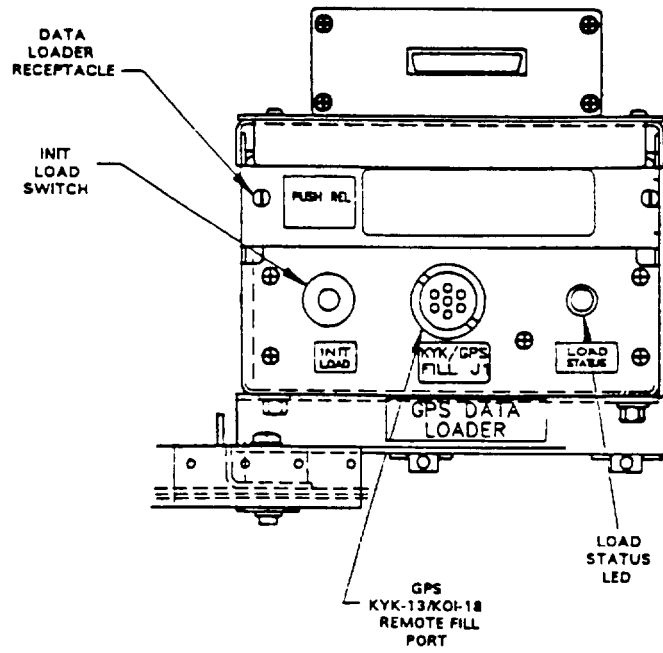


Figure 3-18. Remote GPS Data Loader Receptacle/KYK-13 Fill! Panel



## CHAPTER 4

### MISSION EQUIPMENT

#### SECTION I MISSION AVIONICS

##### 4-1. Radar Signal Detecting Set, AN/APR-39A(V)1.

The radar signal detecting set (RSDS) AN/APR-39A (V) 1 is a passive electronic warfare system that provides visual and aural indications of the presence of and bearing to active radar transmitters. The RSDS detects those pulse radar signals usually associated with hostile fire control radars in the H-J and MMW (millimeter wave) frequency bands. The RSDS is the heart of the helicopter threat warning suite. It interfaces with the laser detecting set AN/AVR-2, missile warning system AN/AAR-47, and radar warning system AN/APR 44(V)3 to process, display, and announce threats detected by those systems. The system consists of the indicator on the center instrument panel (fig. 4-0), a digital processor located in the right aft avionics pod, two video receivers (one at station 50, another at station 605), four spiral antennas (hi-band) outside the helicopter (two at station 26, two at station 623), and a blade antenna (lo-band) mounted on the bottom of the fuselage at station 99. In addition, a separate AN/APR-39A volume control labeled RWR VOL on the canted console provides additional volume control capabilities external of the ICS (fig. 4-1). The RSDS is powered in the No. 2 DC bus through the ASE RADAR WARN circuit breaker on No. 2 PDP.

a. The antenna-detector characteristics determine the frequency range of the system. Each of the antenna-detectors contain two spiral elements, one operating in the H-J bands and one operating in the MMW (millimeter wave) region. Each of the spiral elements receive radio frequency (RF) signals in their respective band and supply it to the detector circuits. The detector portion of the antenna-detector employs an elaborate set of filter banks that extract the video (pulses) from the RF received in each band. The resultant video outputs are then summed and provided as a composite video signal to the appropriate video receiver.

b. Each video receiver has two video input channels and they serve the left and right antenna-detectors for the corresponding forward or aft sector. The video receiver supplies power to the antenna-detectors and amplifies the detected video inputs from the antenna-detectors. Two video outputs are then sent to the digital processor for signal analysis. The video receiver also performs initiated built-in test on command from the digital processor.

c. The digital processor supplies 15 VDC operating power to the two video receivers and superimposes a self-test signal on the 15 VDC power line to the receivers during RSDS self-test. The digital processor receives video inputs from the video receivers and processes them to determine signal parameters. These signal parameters include pulse repetition

interval (PRI), pulse width (PW), pulse spacing (PS), and signal strength. The system does not provide center frequency resolution for detected signals. It then compares these signals parameters to the threat library stored in the emitter Identification data (EID) files. If a match occurs, the digital processor sends the appropriate symbol data to the indicator and a corresponding computer-synthesized voice warning message to the helicopter ICS. If the received signal parameters do not match a threat in the EID files, the processor generates a symbol "U" to indicate an unknown threat. It executes and evaluates the results of an IBIT routine, providing an indication of results on the indicator. Also, it processes threat data inputs from the AN/AVR-2, AN/APR-44(3), and AN/AAR-47 systems for display on the indicator and annunciation over the ICS.

d. The blade antenna senses C/D lo-band RF and routes it to the C/D band amplifier portion of the digital processor. The RF signal is filtered, limited, and detected by the C/D band amplifier with the resultant video being analyzed for the presence of a threat in the C/D band. This analysis occurs in conjunction with the hi-band signal analysis to determine the threat type and current threat mode (scan, acquisition, track, launch, etc.).

e. The RSDS employs a removable user data module (UDM) which is mounted in the digital processor. The UDM contains the classified portion of the system operational flight program (OFP) and the classified emitter identification data (EID) files. The EID files contain the threat library which includes threat signal parameters, threat symbols and threat audio data. The UDM can be removed at the unit level and reprogrammed to accommodate new and changing threats. It allows the RSDS to be tailored to the specific theatre of operation and/or current mission requirements. Removal of the UDM from the digital processor declassifies the RSDS

#### NOTE

Threat symbols (except for U) shown on indicator illustrations are for illustration purposes only. Actual threat symbols are classified.

f. The indicator displays threat symbols corresponding to threat signals detected and identified by the system. Threat relative position from the helicopter is shown on the indicator. Symbol position relative to the center of the indicator shows the threats lethality. The highest priority threats (most lethal) are shown nearest the center. The 12 outer edge markings on the indicator graticule represent clock positions relative to helicopter heading. The system displays a maximum of seven threat symbols. If the number of threats in the environment exceeds the number the system can display, only the seven highest priority threats will be displayed. If a detected threat

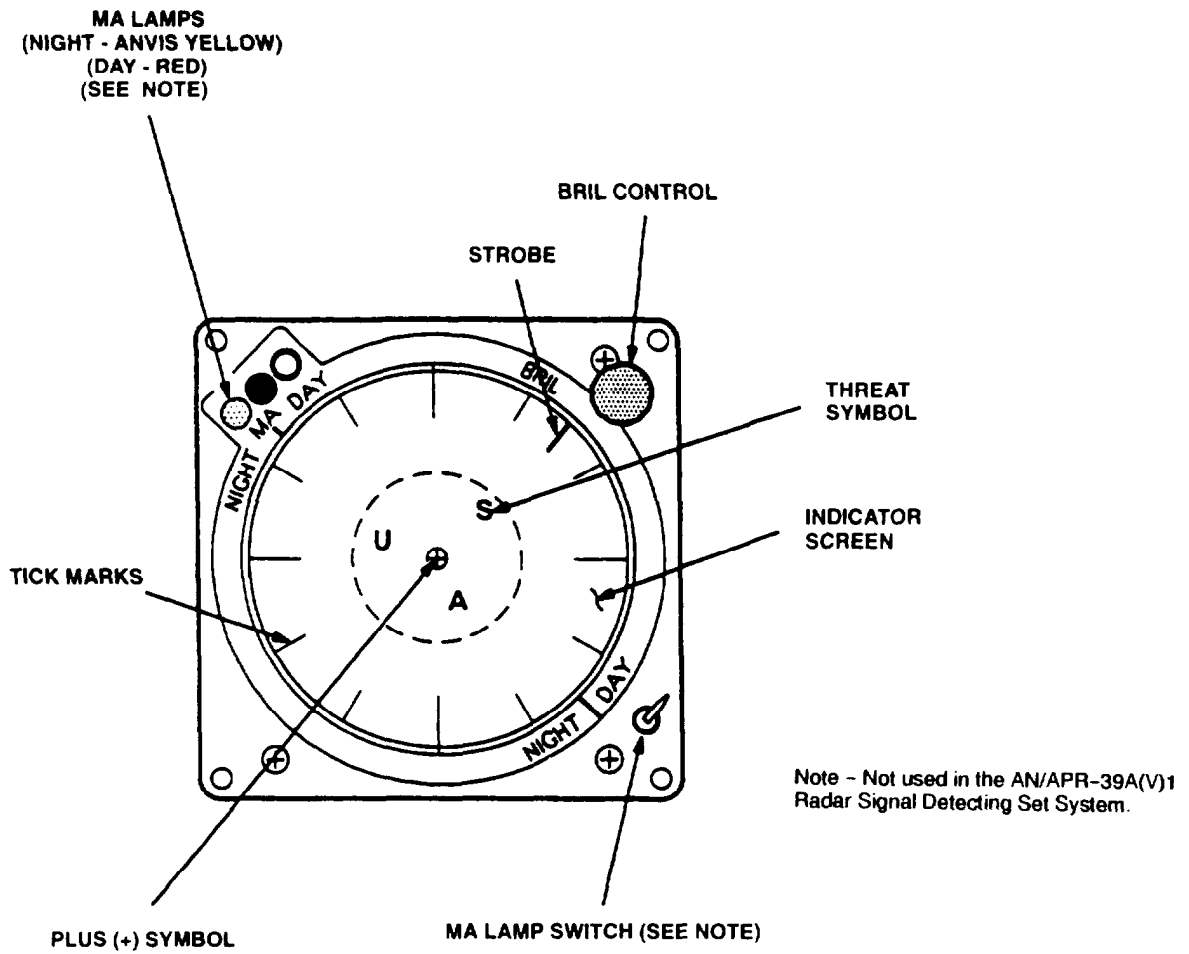


Figure 4-0. Radar Signal Detecting Set Indicator

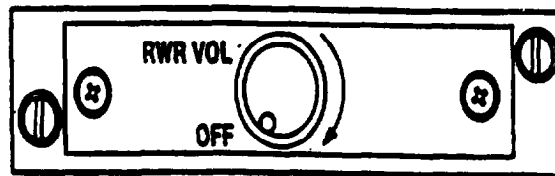


Figure 4-1. AN/APR-39A Volume Control

cannot be identified as a specific threat type, it is displayed as an unknown (symbol U). Search radars and fire control radars operating in search mode are displayed as strobes at the edge of the indicator. The position of the strobe on the display represents the relative bearing of the search radar from the helicopter. New threats appear in boldface on the display. Threats that drop out of the environment are ghosted on the display for **10 seconds** before being dropped. A ghosted symbol appears as though drawn with a dotted line.

g. Threats are announced by voice messages over the helicopter ICS. Either of two voice message formats can be selected using page 2 of the CDU ASE control layer. RWR AUDIO 1 or normal (full message format) selects full audio. RWR AUDIO 2 or terse (shortened message format) provides shorter audio messages and reduces the audio clutter in dense signal environments. Both modes provide specific threat type and threat position voice messages.

h. When dense signal environments cause the system to operate in a degraded (less sensitive) mode, the system informs the operator by flashing the plus (+) symbol on the RSDS indicator and the voice message "Threat Detection Degraded" will be heard over the ICS. When system sensitivity returns to normal, the plus (+) symbol in the center of the RSDS indicator stops flashing and the voice message "Threat Detection Restored" will be heard over the ICS.

i. The RSDS, LDS, and MWS all execute periodic built-in test (PBIT) routines during normal operation to verify operational status with the results of these tests being reported to the digital processor. Failures of PBIT for these three systems are indicated by the presence of an "F" replacing the plus (+) symbol in the center of the RSDS indicator. The "F" informs the operator that one or more of the systems has failed at least some portion of their respective PBIT routines. This prompts the operator to perform initiated built-in test (IBIT) to determine what system(s) has failed and the extent of the failure(s).

j. IBIT may be selected by the operator. If the RSDS interface circuitry within either RTU fails the self-test, the RWR TEST FAIL advisory is displayed on the MFD. Faulty receivers are shown on the indicator as blinking symbols and the voice message "APR-39 Failure" will be heard over the ICS. If the test is good, the voice message "APR-39 Operational" will be heard over the ICS. The RWR FAIL caution is displayed if the RSDS interface circuitry within both RTU's fails while in its normal operating state. Self-test of the laser detecting set (LDS) and the missile warning system (MWS) are incorporated in the RSDS self-test.

k. The system interfaces with the interference blanker unit (IBU) in an attempt to prevent other aircraft systems, which operate in the same approximate frequency range, from interfering with it. The lo-band portion of the RSDS is blanked by the IBU when either the IFF transponder system or the TACAN system is transmitting. The hi-band portion of the system is blanked by the IBU when the radar altimeter sys-

tem, radar beacon transponder system, multimode radar system, pulse radar jammer system, or the CW radar jammer system is transmitting. This blanking is accomplished to prevent the possible detection of false threats as a result of interference induced by these systems. Because the RSDS is a passive system, it does not provide any input to the IBU for the potential blanking of other systems.

**4-2. Controls and Function, Radar Signal Detecting Set Indicator. (fig. 4-0)**

CONTROLS/ INDICATOR	FUNCTION
Indicator Screen (CRT)	Displays the appropriate symbol at the appropriate position for each processed signal received by the antenna detectors.
Plus (+) Symbol	Displayed in center of indicator during operation and self-test. Plus (+) symbol flashes to let operator know when the system is operating in a dense signal environment and threat detection is degraded.
Tick Marks	The 12 outer edge markings on the indicator graticule represent clock positions relative to helicopter heading.
Red MA Indicator	Not used.
Anvis Yellow MA Indicator	Not used.
MA Lamp Switch	Not used.
BRIL Control	Varies the brilliance of the indicator display Turning knob clockwise increases brightness.
Strobe	Indicates that a search radar or a fire control radar operating in search mode has been detected and identified.

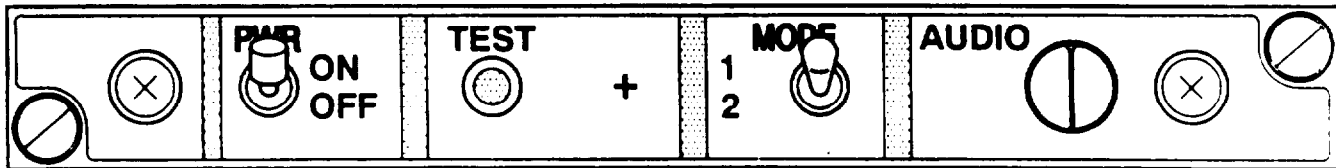
**4-2. Controls and Function, Radar Signal Detecting Set Indicator. (fig. 4-0)(Continued)**

Threat Symbols

Threat symbols correspond to threat signals detected and identified by system. A maximum of seven threat symbols (classified) can be displayed at the same time. Unidentified threat signals are displayed as an unknown (symbol U).

**4-3. Multi-Function Display and Control Display Unit Controls and Function, Radar Signal Detecting Set AN/APR-39A(V)1.**

The radar signal detecting set is turned on via the EQUIPMENT STATUS PAGE 5 OF 5. It is accessed by pressing MFD key T5 SYST until SYST\* is displayed. Then press MFD key L3 EQP STAT to access EQUIPMENT STATUS PAGE 1 OF 5. Access to EQUIPMENT STATUS PAGE 5 OF 5 is accomplished by pressing MFD key R5 PG↑ or R6 PG↓. Press MFD key L1 ↑ SEQ or L2 EQP ↓ to place cursor by RWR then press MFD key R2 PWR OFF to display PWR ON. Access to the ASE control layer is accomplished by pressing CDU dedicated key VCR/ASE. Page 1 of the ASE control layer is displayed. Page 2 is accessed by pressing CDU dedicated key PG ↑ or PG ↓.



**Figure 4-2. Radar Signal Detecting Set Control**

**4-4. Normal Operation - Radar Signal Detecting Set.** This paragraph provides radar signal detecting set operating procedures.

**CAUTION**

To prevent damage to the antenna detectors (when operating) never operate the AN/APR-39A(V)1 within 60 yards of ground based radars or within six yards of airborne radar antennas. Operating the system closer than these limits may damage the antenna-detectors. Allow an extra margin for new, unusual, or high-powered radar transmitters.

**CAUTION**

Excessive indicator display brightness may damage the CRT. Set indicator BRIL control for readable display.

a. *Starting.*

- (1) PWR switch – ON. Allow 1 minute for warm-up – Check for synthetic voice message “APR-39 POWER UP”.
- (2) BRIL control – adjust display of (+ ) symbol.
- (3) MODE switch – Select MODE 1 (up) for normal messages. Select MODE 2 (down) for terse (abbreviated) messages.

b. *Self-test check*

- (1) MODE switch – Set position 1 (up)

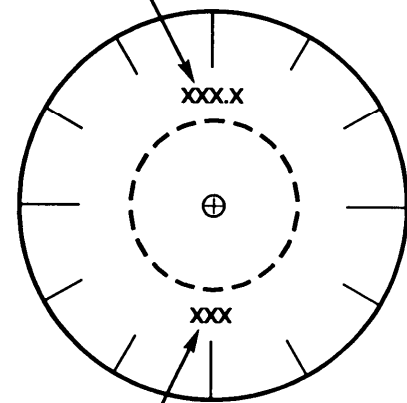
**NOTE**

SYSTEM SELF-TEST provides a six step test of system functions. A complete system self-test is initiated any time the test button is pressed. The complete system self test runs in less than thirty seconds. The following is a description of the system functions.

(2) TEST – As follows:

- (a) TEST switch – Press. A synthetic voice long count is performed. The audio message “SELF-TEST, SET VOLUME 1, 2, 3, 4, 5, 6, 7, 8, 9, 10, 11, 12”...will be heard on the ICS.
- (b) TEST switch – Press. A display of two numbers which represent the installed software revision on the indicator; one number (OFP-Operational Flight Program) at the top and one number (EID-Emitter Identification Data) at the bottom (fig. 4-3). Check OFP and EID numbers are correct for theater or mission.
- (c) TEST switch – Press. Performs the Receiver and AN/AVR-2 status display. See figure 4-4 for normal indicator displays, and faulty indicator displays.

OFF (OPERATIONAL FLIGHT PROGRAM)  
VERSION NUMBER

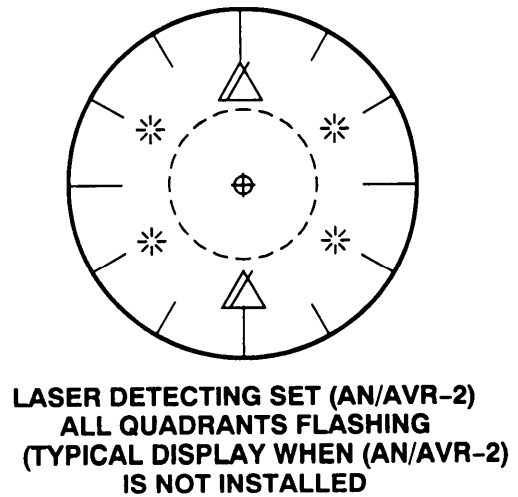
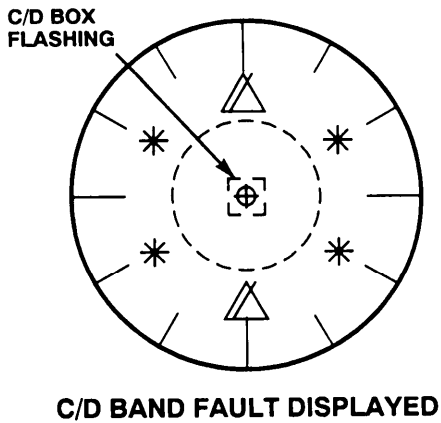
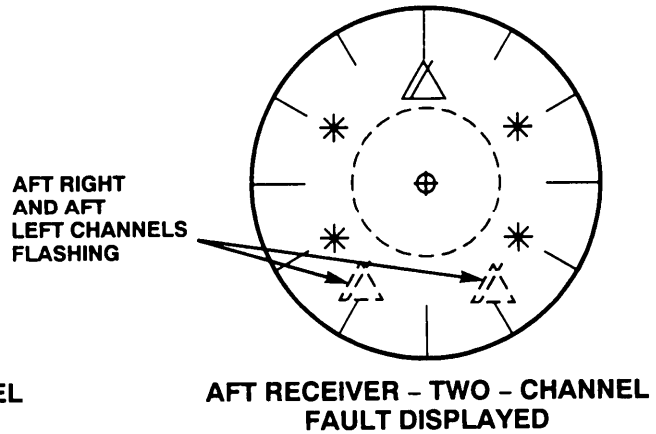
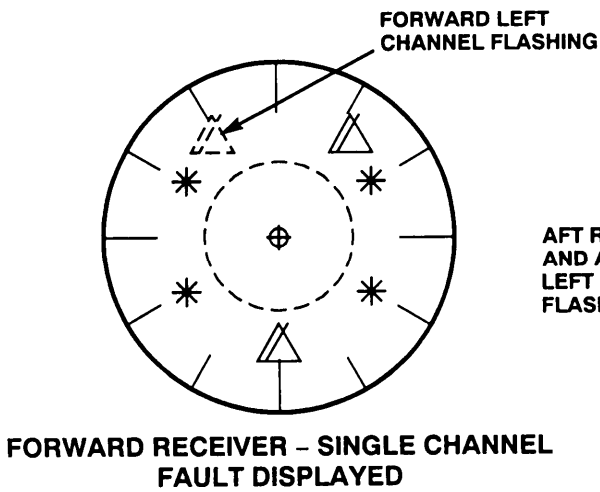
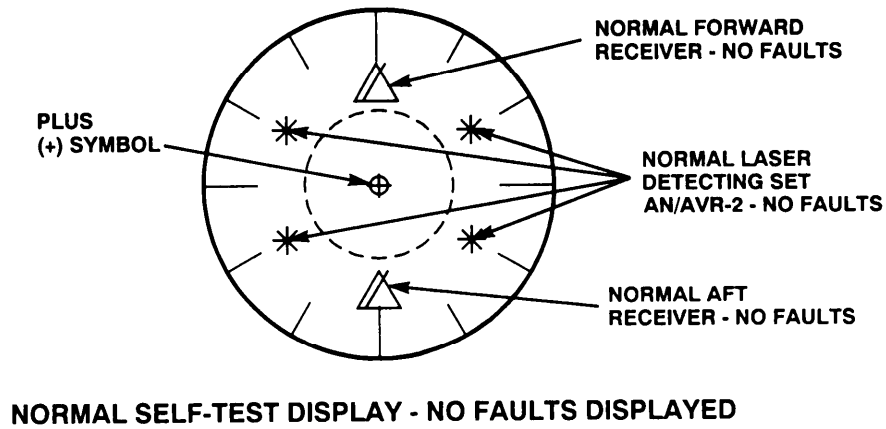


EID (EMITTER IDENTIFICATION DATA)  
VERSION NUMBER

A28565

**Figure 4-3. Radar Signal Detecting Set (OFP and EID VERSION DISPLAY)**

- (d) TEST switch – Press. Performs a test on the synthetic voice status messages. A no fault detected during test will end with message “APR-39 OPERATIONAL” any fault detected will end with message “APR-39 FAILURE”, which will be heard over the ICS.
  - (e) TEST switch – Press. Performs the plus (+) symbol display status. The plus (+) symbol will be displayed, centered within the small circle on the indicator, anytime the system is operational.
  - (f) MODE switch – MODE 2 (down), TEST switch – Press. Performs the synthetic voice short count. Listen to synthetic voice message and adjust volume. Mode 2 short count is: “SELF-TEST SET VOLUME 5, 4, 3, 2, 1.”
- (3) The following fault display conditions are the result of a bad self test, and will result in an audio message “APR-39 FAILURE” over the ICS.
- (a) If a receiver fault is noted, faulty receiver is shown as two triangles, (fig. 4-4) representing right and left video channel(s) will be flashing.
  - (b) A faulty C/D band amplifier in a processor is shown as a flashing square centered on indicator display (fig. 4-4).



A28567

Figure 4-4. Radar Signal Detecting Set Indicator (Self Test Displays)

- (c) The Laser Detecting Set (LDS)(AN/AVR-2) status is displayed along with the receiver status. A faulty LDS quadrant is shown as a flashing asterisk. LDS faults do not cause an audio message “APR-39 FAILURE”, heard over the ICS.
  - (d) If LDS is not installed, all four quadrants (asterisks) will flash.
- (4) Operating In A Dense Signal Environment.
- (a) When a dense signal environment is detected, the plus (+ ) symbol on the Radar Signal Detecting Set (RSDS) indicator will flash, and the voice message “THREAT DETECTION DEGRAD-ED” will be announced over the ICS.
  - (b) Position mode switch to mode 2,(terse mode). When the plus (+) symbol stops flashing, the voice message “THREAT DETECTION RESTORED” will be announced over the ICS.

**4-5. Countermeasures Set (AN/ALQ-156).**

The Countermeasures Set (AN/ALQ-156) detects the approach of anti-aircraft missiles, and signals the M-130 Flare Dispenser to launch flares to decoy the missiles from the helicopter. The set consists of a control unit on the console, a receiver-transmitter in the electronics compartment, two antennas on the bottom of the fuselage, and two caution light capsules on the master caution panel. The set alternately applies pulsed signals to the two antennas which radiate the signals about the helicopter. A missile approach is detected by the frequency shift of the transmitted signals echo returned from the missile. Any echo is received during the

interval following each pulsed transmission. Built-in-test-equipment monitors system operation. If a malfunction is detected, the system is disabled and the CM INOP caution capsule on the master caution panel will come on. Also, if enemy jamming or interference from other countermeasures sets is detected, the set will automatically shift to a clear channel. The set receives AC electrical power from the No.2 AC bus through the MSL DET SYS circuit breaker on the No.2 PDP. The set receives DC power from the No.2 DC bus through the MSL DET SYS circuit breaker also on the No.2 PDP.

**4-6. Controls and Indicators, Missile Detector Set (AN/ALQ-156).** (fig. 4-6)

CONTROLS/ INDICATOR	FUNCTION
POWER OFF/ON	At ON, power is applied to set. The switch is locked at ON. Signals radiate after the normal warmup period is completed.
STBY Indicator Light on STATUS Switch	Lights when switch is depressed and system is in standby operation.
Amber Warmup Caution Light on STATUS Switch	Lights when power is applied to set and remains on until operating temperatures are reached.
FLARE TEST Switch	Simulates launch command signal to flare dispenser.
CM INOP Caution Light (on caution panel)	When lit indicates the set has failed and the helicopter is without countermeasures protection.
CM JAM Caution Light (on caution panel)	Lights when system detects mutual interference from nearby countermeasures sets or enemy jamming.

**Figure 4-5. (Deleted)**

4-7. Normal Operation; Countermeasure Set.

**WARNING**

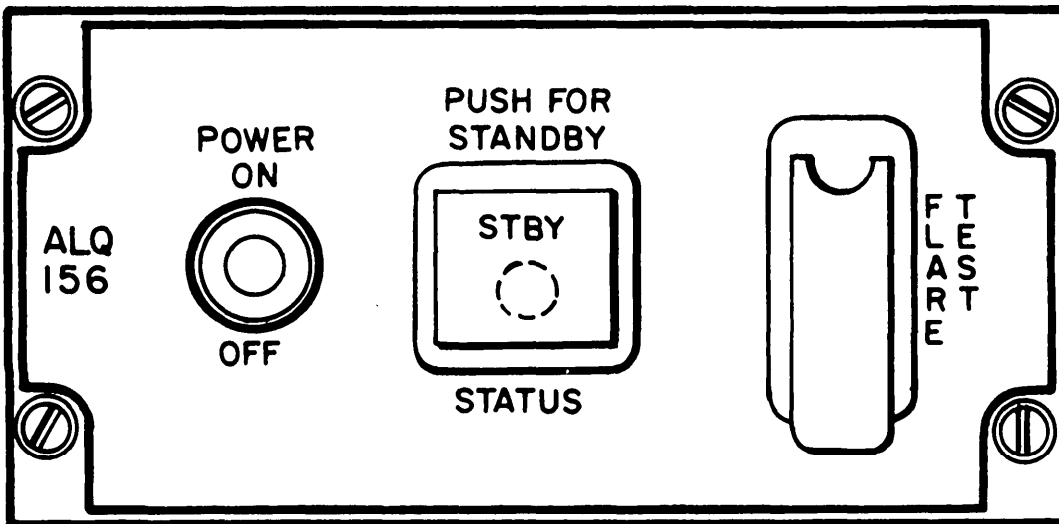
An accidental flare launch can occur when the Flare Dispenser System is armed (control switch at ARM) and the Countermeasures Set is operating (CM caution and indicating lights off). A flare launch will also occur if the FLARE TEST switch on the countermeasures control panel is operated. Arm these systems only in cases where a launched flare will not cause injury or property damage.

**WARNING**

During operation, the AN/ALQ-156 antennas radiate radio-frequency energy. This energy may cause burns to personnel near the antennas. Be sure ground personnel are at least 6 feet from the antennas when the control switch is at ON.

a. Starting.

- (1) MSL DET SYS circuit breakers on No. 2 PDP – Check in.



14692

Figure 4-6. Countermeasures Set Control Panel (AN/ALQ-156)



**WARNING**

The system requires a 10-minute warmup prior to operation. To ensure automatic system operation when required, be sure the set is operational and all caution and indicator lights are out prior to entering hostile areas.

- (2) POWER control switch – ON.
  - (3) Warmup light - ON, allow 10 minutes for warmup. At the end of the warmup period, the warmup light will be shut off.
- b. *ECM operation.*
- (1) STATUS switch – Push for standby operation or release to commence automatic protection.
  - (2) CM JAM caution light – Check OUT.
  - (3) CM INOP caution light – Check OUT. If caution light is on, the set has malfunctioned and the helicopter is without countermeasures protection.
  - (4) POWER switch – OFF when countermeasures protection is no longer required.

**WARNING**

If the countermeasures set has been off for less than 5 minutes and further operation is required, the warmup indicator light may go out immediately (or within some interval less than the normal 10 minute warmup period) after the power switch is set to on. If this occurs, it is mandatory that the system be operated in STBY for at least 1 minute. Failure to observe this requirement can result in a false alarm (launch) and or transmitting frequency instability resulting in interference with other countermeasures sets.

**4-8. Flare Dispenser M-130.**

The Flare Dispenser M-130 (fig. 4-7) will dispense up to 30 decoy flares as a countermeasure to infrared-seeking missiles. The externally mounted dispenser is controlled by a DISP CONT control panel on the console and six firing switches. Two cockpit firing switches are provided, one on each pilot's control stick grip. Four hand-held crewmember firing switches are installed in the cabin area. Flares can also be automatically fired by firing commands from the countermeasure set (AN ALQ-156) if the set detects a missile approach. A timer in the cabin provides a 2.5 second delay between firing pulses regardless of firing switch position. A ground safety relay, controlled by a landing gear proximity switch and a safety pin manually installed into the dispenser, prevents firing flares when the helicopter is on the ground. The system is powered by the No. 1 DC bus through the CHAFF circuit breaker on the No. 1 PDP.

**NOTE**

Although the control panel, dispenser, and circuit breaker are marked CHAFF or have CHAFF (C) selector positions, chaff cannot be dispensed at this installation.

**4-9. Dispenser Control Panel.** The DISP CONT panel is installed in the center console. The panel contains the ARM SAFE switch, ARM indicator light, RIPPLE FIRE switch, FLARE counter, and counter setting knob. The panel also includes a MAN-PGRM switch and CHAFF counter, which are not used in this installation.

**4-10. Dispenser Status Panel.** The dispenser status panel (fig. 4-7) provides an indication of safety relay operation and system arming. It also allows the landing gear safety switch to be bypassed for ground testing of the dispenser system. The panel is on the left side of the cabin at sta 534.

**4-11. Controls and Function, Flare Dispenser System (M-130).** (fig. 4-7)

CONTROLS/ INDICATOR	FUNCTION
ARM/SAFE Switch	At SAFE, the system is not powered. At ARM, the system is powered, provided the safety pin is removed from the electronic module and the ground safety relay is energized. (Helicopter airborne or remote bypass switch on remote test panel is at BYPASS.)
ARM Indicator Light	Red PRESS-TO-TEST warning light indicates, when lit, that ARM/SAFE switch is at ARM, safety relay is closed, and safety pin is not installed in electronic module.
FLARE Counter	Two digit counter displays number of flares remaining in the dispenser. The number of flares loaded is set manually, using the knob directly below the counter.
RIPPLE FIRE Switch	Guarded two-position switch allows rapid emergency ejection of all remaining flares.
CHAFF Counter	Not used in this installation.

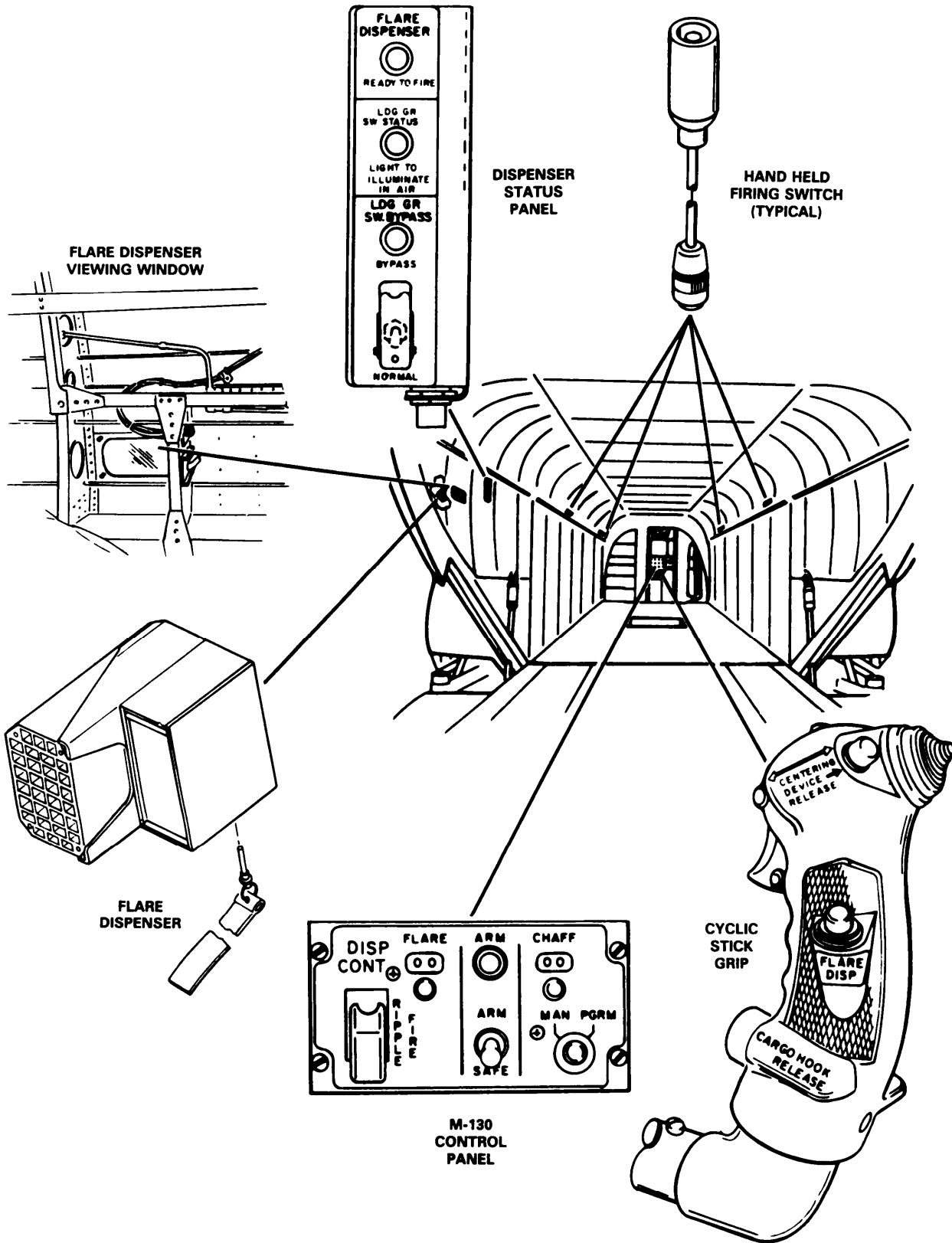


Figure 4-7. Flare Dispenser System

CONTROLS/ INDICATOR	FUNCTION
MAN/PGRM Switch	Light intensity controlled by caution panel DIM/BRT SW.
Dispenser Status Panel	(fig. 4-7)
READY TO FIRE Light	Amber light comes on when system is armed and ready to fire. Light receives power through timer and will go out for 2.5 seconds after flare launch.
LDG GR SW STATUS Light	Green light comes on when ground safety relay is deactivated. The safety relay is deactivated when the helicopter is airborne or bypassed via the LDG GR SW BYPASS switch.
LDG GR SW BYPASS Light	Red light, when lit, indicates that the ground safety relay is bypassed (NORMAL/BYPASS switch is at BYPASS).
NORMAL/BYPASS Switch	Guarded switch. At BYPASS, the landing gear safety switch is bypassed. Switch normally used to test system prior to installing flares.
Cyclic Stick FLARE DISP Switch	Pushbutton switch on side of each cyclic stick. Fires a flare each time when pressed.
Hand Held Firing Switches (4)	Located in forward and aft cabin sections. When pressed, a single flare is fired.

**4-12. Normal Operation - M-130 Flare Dispenser.**

**4-13. Preflight.**

**WARNING**

**An inadvertent flare launch can occur when the Flare Dispenser System is armed (control switch at ARM) and the Countermeasures Set is operating (CM caution and indicating lights off).**

1. Dispenser Assembly.
  - a. Selector switch - Set to F.
  - b. Safety pin - Remove and stow
  - c. Flares - Note quantity installed.
2. Dispenser Status Panel.
  - a. LDG GR SW BYPASS switch - NORMAL Cover down.
  - b. Indicator lights - PRESS-TO-TEST.
3. Cabin hand held firing switches -Check connected and secured in holder.
4. Cockpit Control Panel.
  - a. RIPPLE FIRE switch -Cover down
  - b. ARM/SAFE switch-SAFE.
  - c. FLARE counter - Set to amount of flares in dispenser.

**4-14. In-Flight Operation.**

1. After liftoff, LDG GR SW STATUS advisory light on remote test panel - Check lit.
2. ARM/SAFE switch - ARM. Check ARM warning light lit.
3. READY-TO-FIRE light on dispenser status panel - Check lit.
4. ECM set - ON. Allow 10 minutes for warmup. The ECM set will monitor the area around the helicopter for missiles and automatically fire flares when missiles are detected.

**NOTE**

The flare dispenser can be safely observed from the cabin through the filtered glass window on the left side of the helicopter above the ramp at sta 575.

5. If the ECM set is inoperative, proceed as follows:

**NOTE**

The crewmember observing a missile launch is responsible for firing the flares.

- (a) Missile threat - Actuate the dispensing switch on the cyclic grip to fire flares or chaff or press one of the four firing switches in the cabin to tire flares. Fire a total of three flares or hold button down and timer will automatically space firing interval.

**NOTE**

The flare dispensers will fire one flare each time a button is pressed following the 2.5 second time delay or at 2.5 second intervals if the flare dispense button is held down. If the flare fails to ignite, a second flare will automatically fire within 75 milliseconds. If burning is still not detected, a third flare will be fired. If all three flares fail to ignite, automatic operation will stop until one of the fire switches is again pressed.

**NOTE**

Firing chaff in MAN (manual) mode will dispense chaff one pair at a time or according to the setting of the programmer when set in the PROG (programmed) mode.

(b) Announce over interphone that a missile launch was detected and flares have been fired.

(c) If more than one missile launch is observed, continue firing flares at 3-second intervals until the helicopter is clear of the threat.

**4-15. Before Landing Check.**

1. ARM-SAFE switch-Set to SAFE.
2. Indicator lights - Check that READY- TO -FIRE and ARM lights are out.

**4-16. After Landing Check**

1. Check that the LDG GR SW STATUS light goes out.
2. Install the ground safety pin in the dispenser electronic module.
3. Remove and stow the crew firing switches.

**4-16.1 Heads Up Display (AN/AVS-7) System**

The Heads U Display (HUD) System (fig. 4-7.1) serves as an aid to pilots using the AN/AVS-6 (ANVIS) during night flight operations. The system allows the pilot and copilot to receive flight data without viewing the instrument panel. Instrument data is applied to the system, processed for display, and superimposed over the ANVIS image. The set consists of the Converter Control Unit (CCU) on the console. The Signal Data Converter (SDC) on the avionics shelf, an inclinometer and air data transducer both located on the avionics shelf, a HUD control switch on the pilots/copilots THRUST CONT (control) lever, and the Display Unit (DU), consisting of the Optical Unit (OU) and Power Supply Calibration Unit (PSCU). The CCU selects pilot/copilot programming which allows the pilot and copilot to select information for their respective display modes from a master set of symbols. The pilot and copilot can independently program up to eight display modes, four normal and four declutter, which can be selected for display. Declutter can be used when less symboling is needed. The declutter mode has four vital symbols that will always be displayed: Airspeed, Altitude (MSL), Altitude (pitch and roll), and Engine Torque(s). An adjust mode, during operation, is used to adjust barometric altitude, pitch and roll. If the HUD system loses operating power after adjustments have been made, the barometric altitude, pitch and roll must

be readjusted. The system self test is divided into power-up or operator initialized built-in-test (BIT) and in-flight BIT. The system built-in-test (BIT) is initialized during power-up or selected by the operator. Part of the BIT is a periodic test that is performed automatically along with normal system operation. A failure of the SDC, pilots DU, or copilots DU will illuminate the CCU FAIL light and display a FAIL message on the DU. When a fail message is displayed on the DU, the operator should acknowledge the failure and rerun BIT to confirm the fault. 26-volt AC to operate the HUD system is taken from the No.1 INSTXFMR through the HUD REF circuit breaker on the No.1 PDP DC power for the system is taken from the ESSENTIAL bus through the HUD SYS circuit breaker also on the No. 1 PDP

**4-16.2 Controls and Function, Converter Control Unit. (fig. 4-7.1)**

CONTROLS/ INDICATOR	FUNCTION
<b>CPLT</b>	
BRT/DIM Switch	Three position toggle switch spring loaded to off. When placed to BRT or DIM position momentarily, copilots display will increase or decrease brightness (when held, display will go full bright or full dim).
DSPL POS D/U/L/R	Copilots control for display position down/u (outer knob) and left/right (inner knob).
MODE 1-4/DCLT	Three position toggle switch spring loaded to off. Changes the copilots primary mode and/or primary mode's declutter display.
<b>PLT</b>	
BRT/DIM Switch	Three position toggle switch spring loaded to off. When placed to BRT or DIM position momentarily, copilots display will increase or decrease brightness (when held, display will go full bright or full dim).
DSPL POS D/U/L/R	Pilots control for display position down/up (outer knob) and left/right (inner knob).

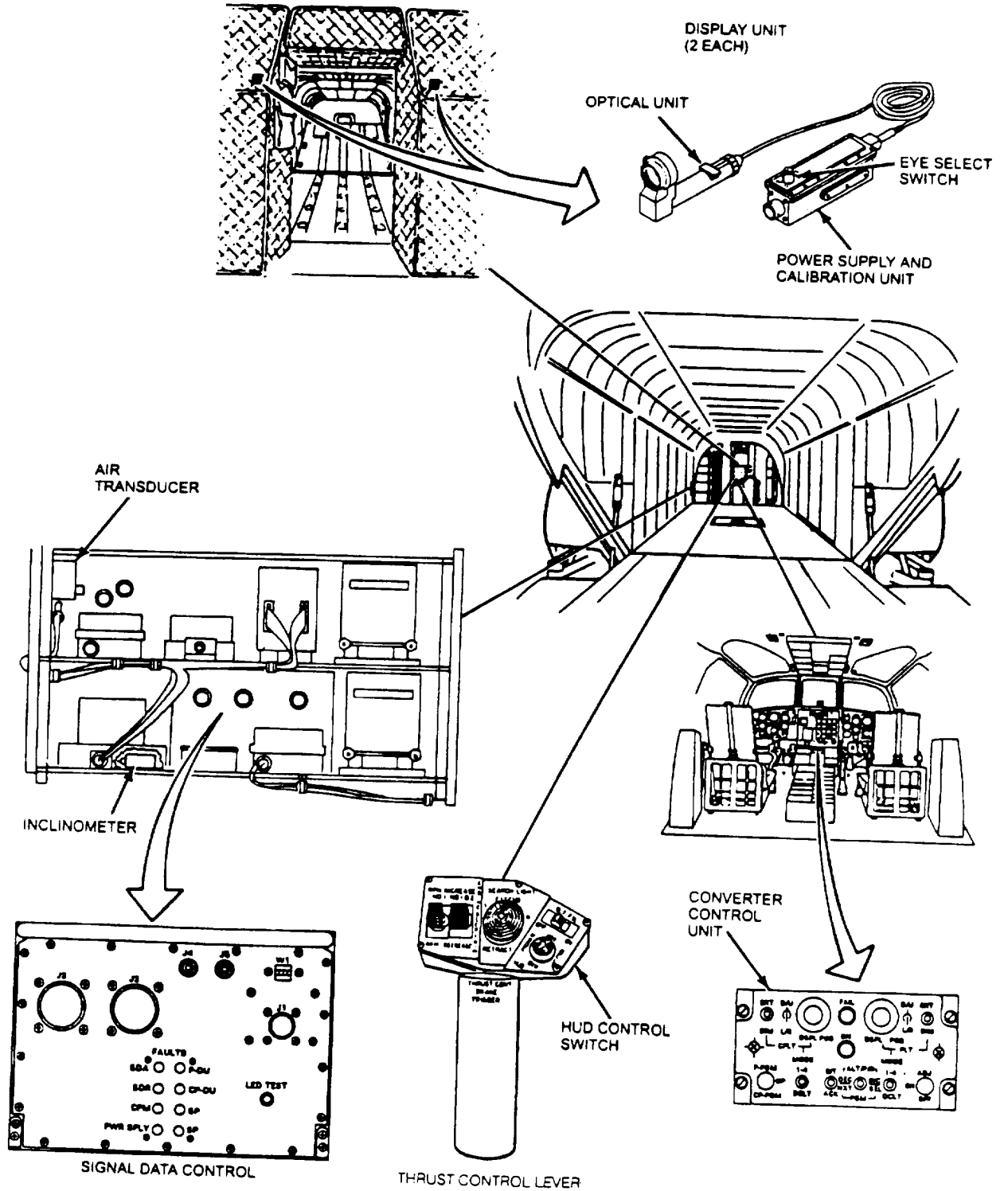


Figure 4-7.1. Heads Up Display A1A V5-7

CONTROLS/ INDICATOR	FUNCTION
MODE 14/DCLT Switch	Three position toggle switch spring-loaded to off. Changes the pilot's primary mode and/or primary mode's decluttered display. Refer to paragraph 4-16.11 for detailed procedures.
ADJ/ON/OFF Switch	Three position switch. Selects adjust mode, enabling the INC/DEC switch to adjust altitude, pitch or roll. Turns power on/off to HUD system.
FAIL Light	Illuminates to indicate a system failure.
ON Light	Illuminates to indicate when system is powered up.
P-PGM/OP/CP-PGM Switch	Three position switch. Selects pilot program mode, operational mode or copilot program mode. Used with the PGM NXT/SEL switch.
BIT/ACK Switch	Three position toggle switch spring-loaded to off. Placed to BIT momentarily, selects built-in-test. Placed to BIT position and held, changes display to symbol generator test mode until switch is released. When placed to ACK, used to acknowledge displayed fault, completion of adjustment. or completion of programming sequence. After ACK is used to acknowledge a fault, fault will not reappear until BIT is selected or power is cycled off and on.

CONTROLS/ INDICATOR	FUNCTION
ALT/P/R DEC/INC Switch	Three position toggle switch spring-loaded to off. Active when adjust mode is selected to decrease/increase altitude /pitch /roll. When adjusting altitude (MSL) momentary movement of DEC/ INC switch will change data in 5 ft increments. When DEC/INC switch is held for one second, data will change in 10 ft increments. Pitch and roll change in increments of 1 degree.
PGM NXT/SEL	Three position toggle switch spring-loaded to off. Active when program mode is selected. Operator can preprogram four normal modes and four declutter modes. Operator selects flashing symbol for display or goes to next symbol. Once complete, operator toggles ACK switch to save programmed display. To program full display, use ACK after changing to new mode.

**4-16.3. Controls and Function, Pilot/Copilot HUD Control (THRUST CONT Lever). (fig. 4-7.1)**

CONTROLS/ INDICATOR	FUNCTION
BRT/DIM	Allows pilot/copilot to control brightness of their respective displays.
MODE/DCLT	Allows pilot/copilot to select respective display modes or declutter modes.

**4-16.4. Controls and Function, Display Unit.(fig. 4-7.1)**

CONTROLS/ INDICATOR	FUNCTION
EYE SELECT	Selects the proper orientation of the symbology for left or right eye viewing.

**4-16.5. Modes of Operation.**

There are two programming modes and one operational mode for the HUD system selected by the programming switch on the CCU. The adjust mode is a sub-mode under the operational mode.

- b. Copilot programming - switch set to CP-PGM.
- c. Operation (flight mode) - switch set to OP. (Adjust - ADJ/ON/OFF switch to ADJ).

**4-16.6. Display Modes.**

Symbology display modes are programmable by the pilot and copilot via the converter control unit located on the console. Modes are defined by selecting from a master symbology menu (fig. 4-7.2 and 4-7.3). Up to eight (8) display modes, four normal and four declutter can be programmed for each user and can be selected for display using the display mode selection switch on the pilot or copilot thrust control lever or on the CCU. The default declutter mode has a minimum symbology display of:

- a. Pilot programming - switch set to P-PGM

- Airspeed - No. 25
- Altitude (MSL) - No. 7
- Attitude (pitch and roll) - Nos. 5, 6, 20, 26
- Engine Torque(s) - No. 22, 23

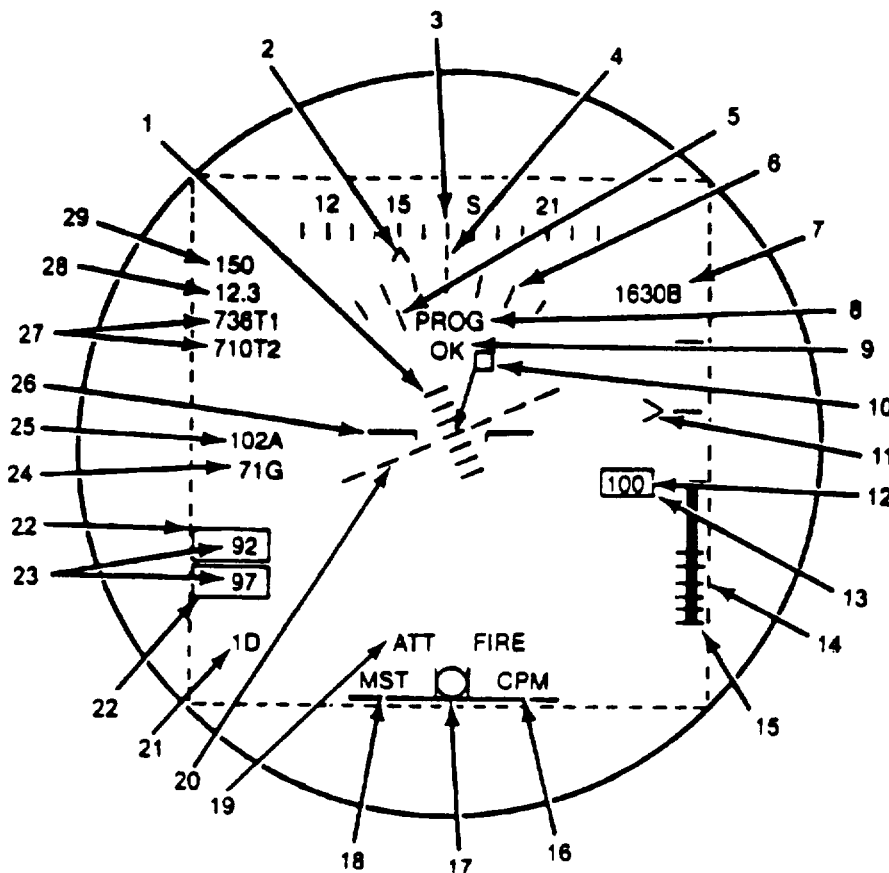


Figure 4-7.2. CH-47D HUD Master Mode Display

No.	Symbol	Source	Range/Description
1	Angle of Pitch Scale	HUD System	$\pm 30^\circ$ (100 units, tic marks flash when angle of pitch is $>+ 30^\circ$ )
2	Bearing to Waypoint - Pointer	Doppler	0 - 359° (cursor will invert "V" when aircraft is moving away from waypoint)
3	Compass Reference Scale	HUD System	0 - 3590 (100 units)
4	Aircraft Heading Fix Index	HUD System	Fixed Reference Mark
5	Angle of Roll - Pointer	Vertical Gyro, Copilot	$\pm 300$ (right turn moves pointer to right, pointer flashes $> \pm 300$ )
6	Angle of Roll - Scale	HUD System	$\pm 300$ (100 units)
7	Barometric Altitude (MSL)	Air Data Transducer	-1500 to 20,000 feet (set during adjustment mode)
8	Adjust/Program Mode Message	HUD System	ADJ or PROG
9	OK/Fail	HUD System	OK or FAIL
10	Velocity Vector	Doppler	0 - 15 knots/15 kilometers, 0 - 3590
11	Rate of Climb Pointer No. 15)	Air Data Transducer	$\pm 2000$ feet-per-minute (used with vertical speed scale,
12	Radar Altitude (AGL) - Numeric	Radar Altimeter, Pilot	0 - 1000 feet (0 - 200 feet, 1 foot units; 200 - 1000 feet, 10 foot units; disappears above 999 feet, and reappears below 950 feet)
13	Minimum Altitude Warning	Radar Altimeter, Pilot	Blinking square around symbol - No. 12, set on pilot's radar altimeter (use low set index)
14	Radar Altitude (AGL) Analog Bar	Radar Altimeter, Pilot	0 - 200 feet (disappears at 250 feet, reappears at 225 feet; digital readout symbol, No. 12)
15	AGL, Vertical Speed - Scale	HUD System	0 - 200 feet/ $\pm 2000$ feet-per-minute
16	HUD Fail Message	HUD System	CPM, SDR, SDA, PS, PDU, CPDU, NAV, PGM; can be cleared from the display by selecting "ACK" (See NOTE)
17	Trim (Slide Ball)	Inclinometer	$\pm 2$ balls (left/right)
18	MST, MEM, HOOK Messages	Master Caution Panel	MST, MEM, HOOK; cannot be cleared from the display by selecting "ACK"

NOTE: After ACK is used to acknowledge a fault, the fault will not reappear until BIT is selected or power is cycled off and on.

Figure 4-7.3. CH-47D HUD Master Mode Symbology Display (Sheet 1 of 2)

#### 4-8.4 Change 7



No.	Symbol	Source	Range/Description
19	Sensor, Fire Warnings	Light Plate Ass'y, Cockpit	ATn (failure of copilot VGI), MSL, IAS, FIRE; ATT, MSL, and IAS can be cleared from the display by selecting "ACK" (See NOTE). FIRE cannot be cleared.
20	Horizon Line (pitch roll)	Vertical Gyro, Copilot	Pitch: ± 30° Roll: 0 - 359°
21	Display Mode Number	HUD System	IN - 4N for normal modes, ID - 4D for declutter modes
22	Torque Limits	Torque Transducer	(> 100%, solid box) (> 123%, Thresholds, solid box flashes)
23	Torque - Numerics	Torque Transducer	0 - 130% (flashes when engine torque separation is greater than 5% threshold) Max % torque split between cockpit panel and HUD is 3%
24	Ground Speed	Doppler	0 - 999 knots/ 0 - 530 km/h (dependent on doppler)
25	Indicated Airspeed	Air Data Transducer	0 - 220 knots (no symbol 00 knots and below, reappears at 02 knots)
26	Attitude Reference	HUD System	Represents helicopter Indicator
27	Engines Temperature	Thermocouple Amplifiers	0 - 9990C (0 - 755 C, 20 units; 7760C - 9990C, 1° units) Max split between cockpit and HUD is ±15
28	Distance to Waypoint	Doppler	0 - 999.9 km
29	Bearing to Waypoint - Numeric	Doppler	0 - 3590

NOTE: After ACK is used to acknowledge a fault, the fault will not reappear until BIT is selected or power is cycled off and on.

**Figure 4-7.3. CH-47D HUD Master Mode Symbology Display (Sheet 2 of 2)**

**416.7. Operation.**

**416.8. Starting Procedure.**

1. ADJ/ON/OFF switch - OFF.
2. Optical unit support clamps - Installed on ANVIS. Verify clamps can be rotated.

**NOTE**

Check surface of lens for cleanliness. Clean in accordance with TM 11-5855-300-10.

3. DU lens - Check.

**WARNING**

**Failure to remove the ANVIS neck cord prior to operation of the HUD may prevent egress from the aircraft in an emergency and may result in serious injury or death.**

4. ANVIS neck cord - Removed.
5. Optical unit Install on ANVIS. Attach Optical Unit (OU) to either ANVIS monocular housing. Do not tighten OU clamp completely with thumbscrew at this time. The OU (display) may have to be rotated to horizon after the system is operating.

**NOTE**

The helmet may now have to be rebalanced.

6. EYE SELECT switch on PSCU - L or R.

**WARNING**

**CCU ADJ/ON/OFF switch must be OFF before connecting or disconnecting quick release connector.**

**CAUTION**

**The AN/AVS-7 system should not be used if the quick-release connector is not in working order.**

7. PSCU Connect. Connect PSCU to quickrelease connector by rotating the connector engagement ring.

**CAUTION**

**Keep the protective caps on the ANVIS whenever it is not in use. Operate the ANVIS only under darkened conditions.**

**NOTE**

Ensure ANVIS operator procedures have been completed.

8. P-PGM/OP/CP-PGM switch - OP.

**NOTE**

The system ON and FAIL lights will not be visible if the center console lights are turned off.

9. ADJ/ON/OFF switch - ON. SYS ON and FAIL lights illuminate and BIT will initiate automatically.
10. FAIL light - Check. Light should go out after ten seconds. BIT is complete.

**NOTE**

Allow 1 minute for display warmup. Display intensity is preset to low each time ADJ/ON/ OFF switch is set from OFF to ON.

If a fault is displayed in the DU, acknowledge fault and re-run BIT to confirm fault. If the fault remains notify AVUM personnel.

11. BRT/DIM switch - As desired.
12. DSPL POS control As required. Center display in field of view.
13. Display aligned to horizon Check. Tighten OU clamp.

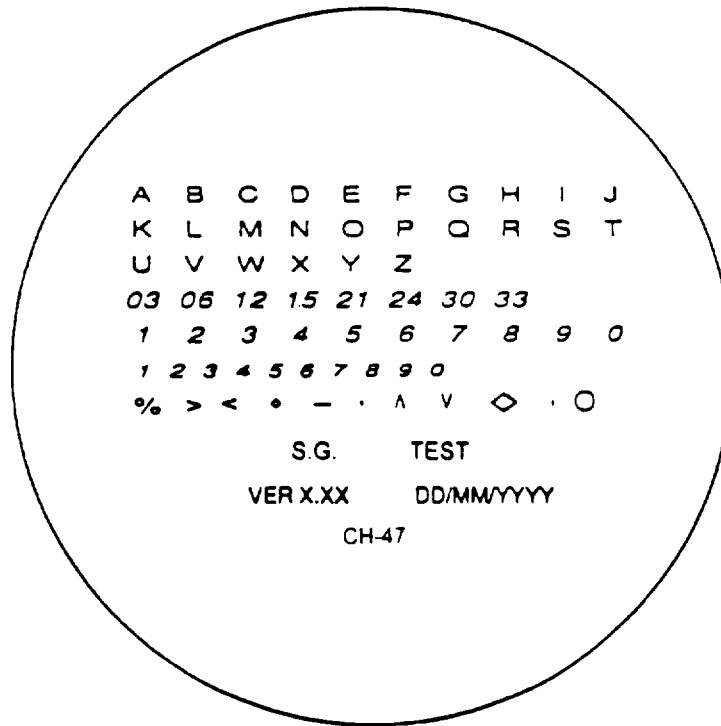
**4-16.9. Operator Self Test (BIT).**

1. BIT/ACK switch Press to BIT and hold. The ON and FAIL LIGHT will illuminate. At end of BIT, FAIL indicator will extinguish (lamp will not be visible when center console lights are off).
2. Display Unit(s) Verify symbol generator test mode software for CH-47 (figure 4-7.4).
3. BIT/ACK switch - Release.

**4-16.10. Displayed System Faults.**

The system self test is divided into power-up or operator initialized built-in-test (BIT) and in-flight BIT. The faults result as warnings and messages that blink at a rate of two per second in the Display Units.

Part of the BIT is a periodic test that is performed automatically along with normal system operation. This BIT monitors and/or tests SDC functions and/or signals. A failure of the SDC. NAV signals, pilot's DU, or copilot's DU will illuminate the converter control FAIL light and display a FAIL message CPM. SDR, SDA. PS NAV, PDU or CPDU on the Display Unit. An ATT (gyro invalid), IAS (indicated air speed out of range), or MSL (MSL altitude out of range) sensor failure warning message will be displayed when condition exists. ATT, IAS, MSL, NAV, PDU, CPDU. And all SDC faults can be cleared by setting BIT/ACK switch to ACK.



**NOTE: VERSION NUMBER AND DATE WILL CHANGE AS SOFTWARE IS UPDATED.**

**Figure 4-7.4. Symbol Generator Test Mode**

The following helicopter status messages are also displayed.

1. The caption MST (first priority) indicates operation of the master caution warning lamp. This message will disappear during the reset of the main warning lamp operation.
2. The caption MEM (second priority) indicates that the doppler data is not updated. A previous computed data is available. This message will appear simultaneously with the MEM lamp on the doppler operating panel.
3. The caption HOOK (third priority) indicates the selected cargo hook has been opened in the helicopter. The message will appear after the reset of the master caution warning light when any of the cargo hooks have been opened.

Setting BIT/ACK switch to ACK will not clear MST, MEM, HOOK status messages, or FIRE warning from the DU.

**4-16.11. Programming Procedure.**

**NOTE**

The programming procedure for the pilot and copilot is identical except for the location of controls on the CCU.

1. Select mode to be programmed (IN through 4N). The first mode that will appear is "IN" (Normal Mode 1).
2. P-PGM/CP-PGM/OPR switch - P-PGM or CP-PGM.

3. "PROG" blinking in display Check. Verify that a complete set of symbology is displayed and attitude reference symbol is blinking. Verify "PGM" is displayed in the HUD FAIL message location for the DU not being programmed.

4. BIT/ACK switch ACK to program the full display or go to step 5 and select desired symbols.
5. PGM SEL/NXT control SEL to select symbol. Selected symbol stops blinking. If symbol is not desired, toggle switch to NXT and the symbol will disappear.

**NOTE**

All symbols have been programmed when the "PROG" annunciator is the only symbol flashing.

6. BIT/ACK switch - ACK. (Hold switch to ACK for one second.)
7. "OK" displayed - Check. ("OK" will be displayed for two seconds.)

**NOTE**

If programming is not accepted, "FAIL" will be displayed. If a fail message is displayed, attempt to reprogram the same mode, if fail reappears notify maintenance.

Declutter mode is recognized by flashing ground speed indicator in lieu of attitude reference symbology.

8. MODE 1-4/DCLT switch - DCLT (ID through 4D). The first DCLT mode that will appear is "ID" (Declutter Mode 1).

**NOTE**

If MODE 14/DCLT switch is toggled to DCLT a second time the display will cycle back to the DCLT's normal mode (1N-4N). The MODE 1-4/DCLT switch must be set to MODE 14 to advance to another normal mode.

9. Repeat steps 4 through 7. for declutter.
10. Mode 1-4/DCLT switch - As required.
11. Repeat steps 4 through 10 until all desired modes are programmed.
12. P-PGM/CP-PGM/OP switch - OP.

**WARNING**

**An improperly adjusted barometric altimeter will result in an improperly set HUD barometric altitude display.**

**NOTE**

Barometric altimeter set to the most current altimeter settings, field elevation.

**4-16.12. Adjustment of Barometric Altitude, Pitch, and Roll.**

1. Ensure P-PGM/OP/CP-PGM switch is in the OP position.
2. ADJ/ON/OFF switch - Pull and set to ADJ.

**NOTE**

Changes to barometric altimeter settings will require a corresponding change to the HUD barometric altitude. Each 0.01 inch change in pressure equals 10 feet.

3. ADJ blinking in display - Check.
4. INC/DEC switch - as required.
5. BIT/ACK switch - ACK.

6. Repeat steps 3 through 5 for pitch and roll.
7. ADJ/ON/OFF switch - ON.

#### 116.13. In-flight Operation.

##### **WARNING**

Whenever the symbology displayed in the DU is suspected of being incorrect the pilot will compare the data with the aircraft instrument indicator and take the appropriate action.

##### **WARNING**

Excessive brightness of the symbology display may impair vision outside the cockpit.

##### **WARNING**

Interruption of electrical power, such as change over from APU generator to NO. 1 and NO. 2 generators and vice versa, will cause the DU to default to minimum brightness and normal MODE IN. Any adjustments made to the barometric altitude, pitch and roll prior to flight will be lost, thereby decreasing the accuracy of the barometric altitude, pitch and roll.

1. BRT/DIM switch - As desired.

##### **NOTE**

Whenever the symbology is interfering with the outside visibility, declutter may be selected to remove symbology.

2. MODE 1-4/DCLT switch - As required.

#### 4-16.14. System Shutdown Procedure.

1. Set ADJ/ON/OFF switch - OFF.
2. Turn off ANVIS.

##### **WARNING**

CCU ADJ/ON/OFF switch must be OFF before connecting or disconnecting quick-release connector.

##### **WARNING**

Do not disconnect DU by pulling on the cable connected to the PSCU. The DU could be damaged or the cable may separate from the PSCU creating an explosive atmosphere hazard.

##### **WARNING**

Do not attempt to egress the aircraft without performing disconnect as this may result in neck injury.

##### **CAUTION**

Do not disconnect DU by pulling on the cable. To do so may damage the DU.

3. Display Unit - Disconnect. Disconnect DU by grasping the PSCU and rotating the quick-release connector engagement ring and pull downward. Remove OU by loosening thumb-screw on OU and remove OU from the ANVIS and place into protective storage case.
4. Reattach neck cord to ANVIS.

**4-16.15. Emergency Egress**

The quick-release feature allows you to exit quickly from the aircraft in an emergency without:

- a. Damaging or turning the unit off.
- b. Getting tangled in cords.
- c. Being restrained in the cockpit by hardwired connections.
- d. Removing ANVIS.

It is up to the operator to determine the desired mode of disconnect based upon his evaluation of the

emergency condition and whether or not the ANVIS goggles will be needed following egress. The available means of disconnect are as follows:

- a. Release the ANVIS goggles from the helmet.
- b. Disconnect the OU from the ANVIS goggles via the thumbscrew.
- c. For routine disconnect, take hold of PSCU and rotate the quick-release connector engagement ring and pull downward.
- d. For emergency disconnect, take hold of PSCU and pull down.

**4-8.10 Change 7**

## SECTION II ARMAMENT

### 4-17. Armament Subsystems.

The armament subsystems, (fig. 4-8) are the M24, and M41 machine guns installed in the cabin door, cabin escape hatch, (M24) and on the ramp (M41). The two flexible 7.62 mm machine guns (M60D) (fig. 4-9) are free pointing but limited in traverse, elevation, and depression by cam surfaces, stops on the pintles, and pintle posts of the left and right mount assemblies (fig. 4-10). Spent cartridges are collected by an ejection control bag on the right side of the machine gun, and an ammunition can is on the left side (fig 4-11).

### 4-18. Machine Gun.

The 7.62 machine gun (M60D) is a link-belt-fed gas-operated air-cooled automatic weapon. Refer to TM 9-1005-224-10

### 4-19. Mount Assemblies (M24).

The mount assemblies (fig. 4-12) are installed on mounting brackets fastened inside the helicopter and secured with mounting pins.

### 4-20. Machine Gun Controls.

For information on the operation and maintenance of the M24 and M41 machine gun systems, refer to TM 9-1005-224-10 and 9-1005-262-13.

#### **WARNING**

To prevent injury to personnel, the cocking handle must be returned to the forward or locked position before firing.

#### **WARNING**

Pressing the trigger to release the bolt accomplishes feeding and releasing of the firing mechanism. Unless firing is intended, make sure the machine gun is cleared of cartridges before pressing the trigger.

#### **CAUTION**

To prevent damage to the cartridge tray when no ammunition is in the machine gun, retard the forward force of the released bolt by manually restraining forward movement of the cocking handle.

### 4-21. Mount Assembly Stops, Cams, Quick-Release Pin, and Shock Cord (M24).

The mount stops, cams, quick-release pin, and shock cord have the following functions:

- a. Maximum traverse (table 4-1) of the machine gun are controlled by stops on both sides of the cam on the pintle post.
- b. Maximum elevation and depression are controlled by cam surfaces on the pintle.
- c. The quick-release pin (fig. 4-12) is attached by cable to the mount bracket of the mount and fastens the mount bracket to the rear bracket at the helicopter opening.
- d. The shock cord (fig. 4-13) is fastened to the mount bracket and to the machine gun when stowed.

### 4-22. Operation - Armament Subsystem M24.

Operate the ARMAMENT SUBSYSTEM M24 as described in the following paragraphs.

**4-23. Preflight Checks.** The preflight check consists of the following:

1. Machine Gun M60D – Check to make sure that gun is thoroughly cleaned and lubricated, operable, and secured on the pintle with the quick-release pin (fig. 4-16).
2. Ejection control bag (fig. 4-14) – Installed and securely latched.
3. Ammunition can (fig. 4-15) – Installed on machine gun and loaded.
4. Safety – Push button to safe (S) position, aim at clear area, and try to fire the unloaded machine gun.
5. Mount – Secured and checked for free pintle movement.
6. Extra ammunition boxes – Properly stowed.

### 4-24. Before Takeoff Check.

1. Check the weapon safety is on – (S) position.
2. Inspect the chamber to be sure it is clear.

**Table 4-1. Armament Subsystem M24 Data**

Effective range	1100 meters (max)
Rate of fire	550-650 rnds per min.
Length, overall	44.875 in.
Sighting	Aircraft ring and post type
Total traversing capability - left side	122°
Total traversing capability - right side	127°
Depression and elevation limits:	
Left side maximum depression	67°30'
Left side maximum elevation	7°30'
Right side maximum depression	73°
Right side maximum elevation	7°

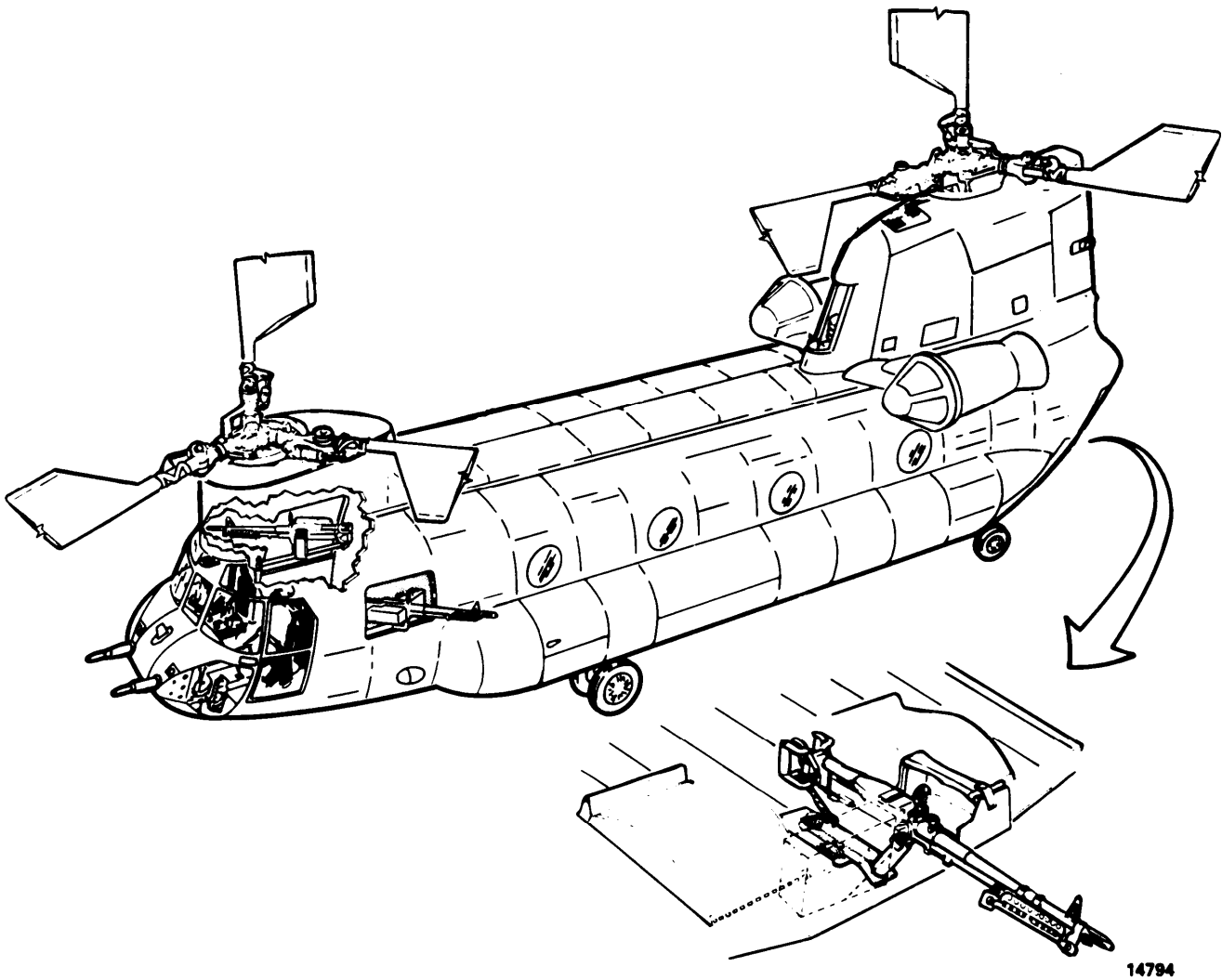


Figure 4-8. Armament Subsystem



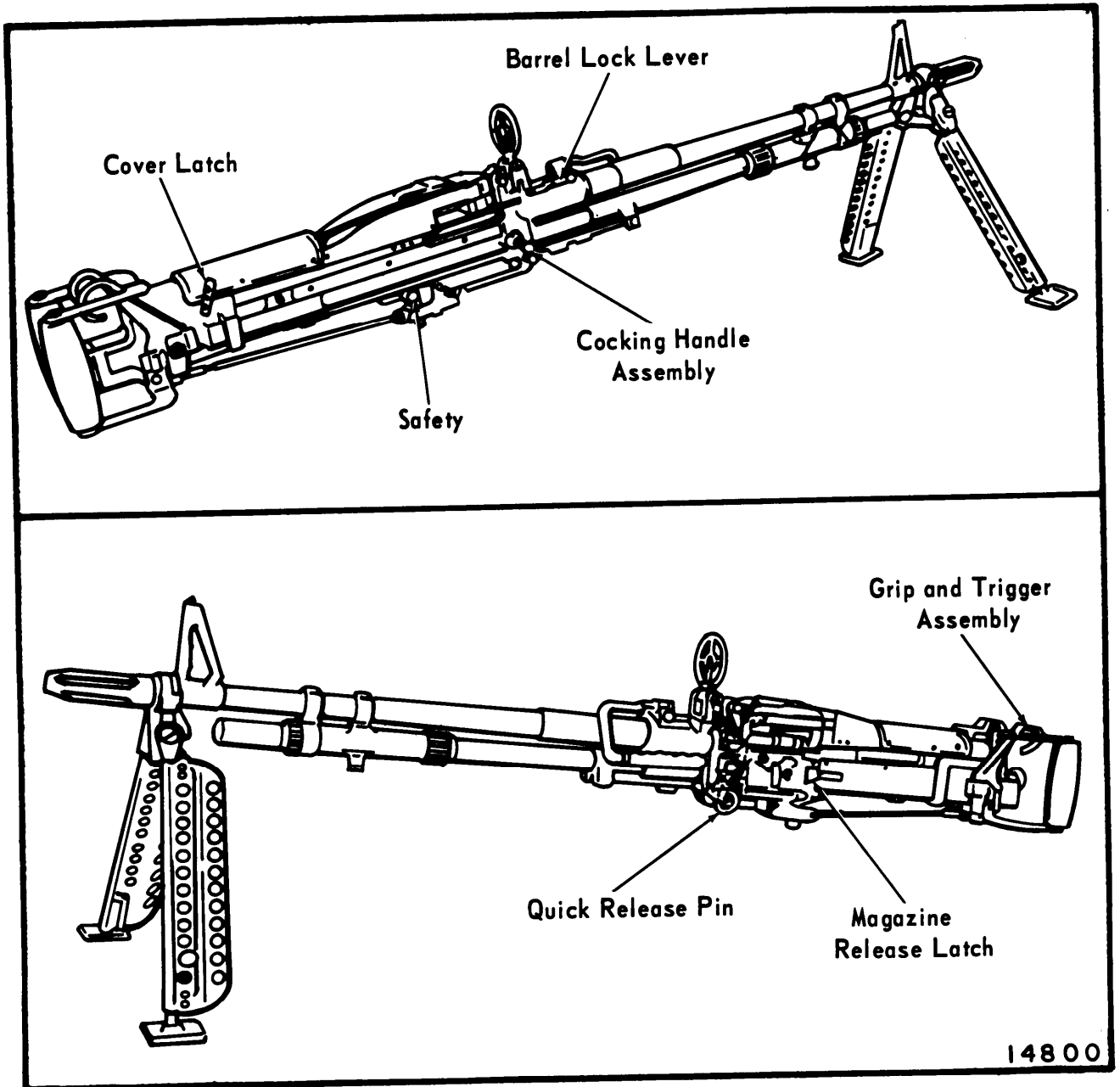


Figure 4-9. Machine Gun M60D

3. Close the cover and secure the machine gun in stowed position.

c. Load the linked cartridges into the machine gun.

**4-25. Inflight Operation.** Inflight operation consists of the following:

1. Preparation for firing.
  - a. Check the machine gun to see that it is secured with a quick-release pin on the pintle (fig. 4-16).
  - b. Check the machine gun for freedom of movement in elevation, depression, and traverse.

**NOTE**

Inspect the linked cartridges to make sure they are securely positioned in the links.

**NOTE**

The pilot will alert the gunners when there is need to fire the machine gun.

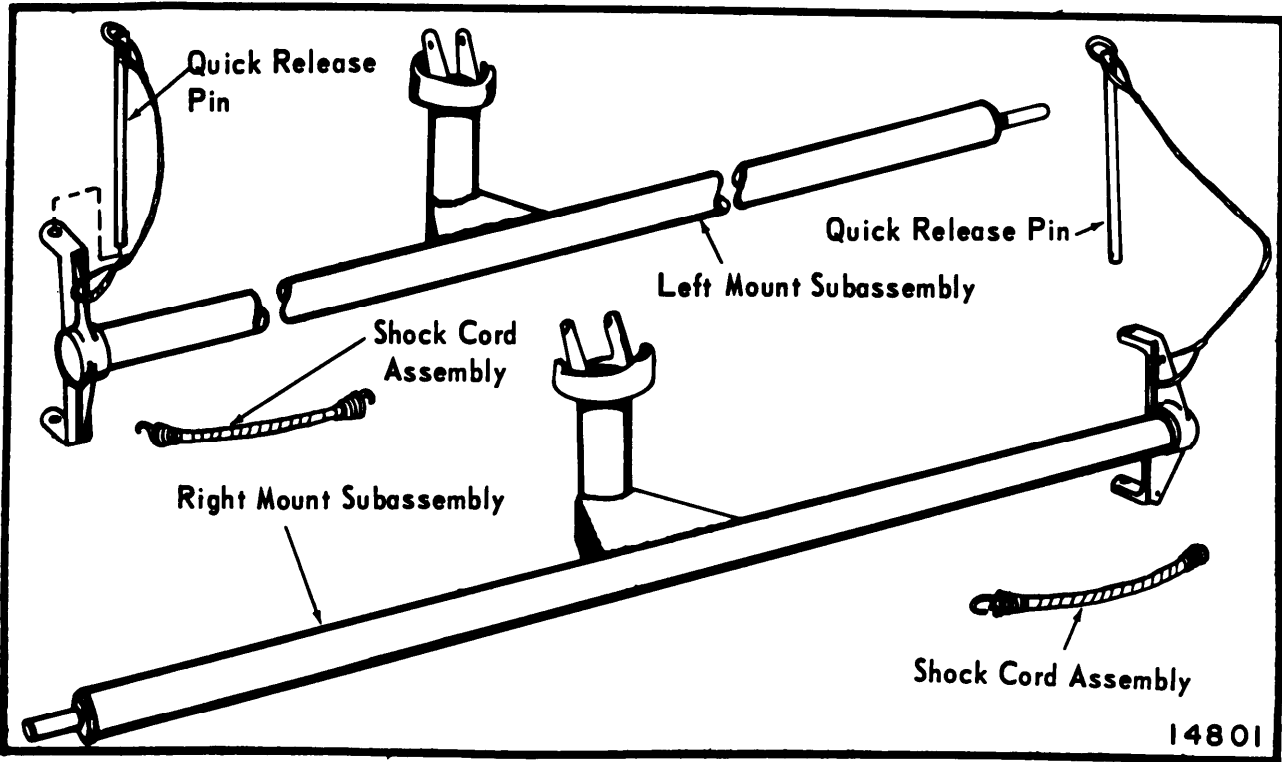


Figure 4-10. M24 Mount

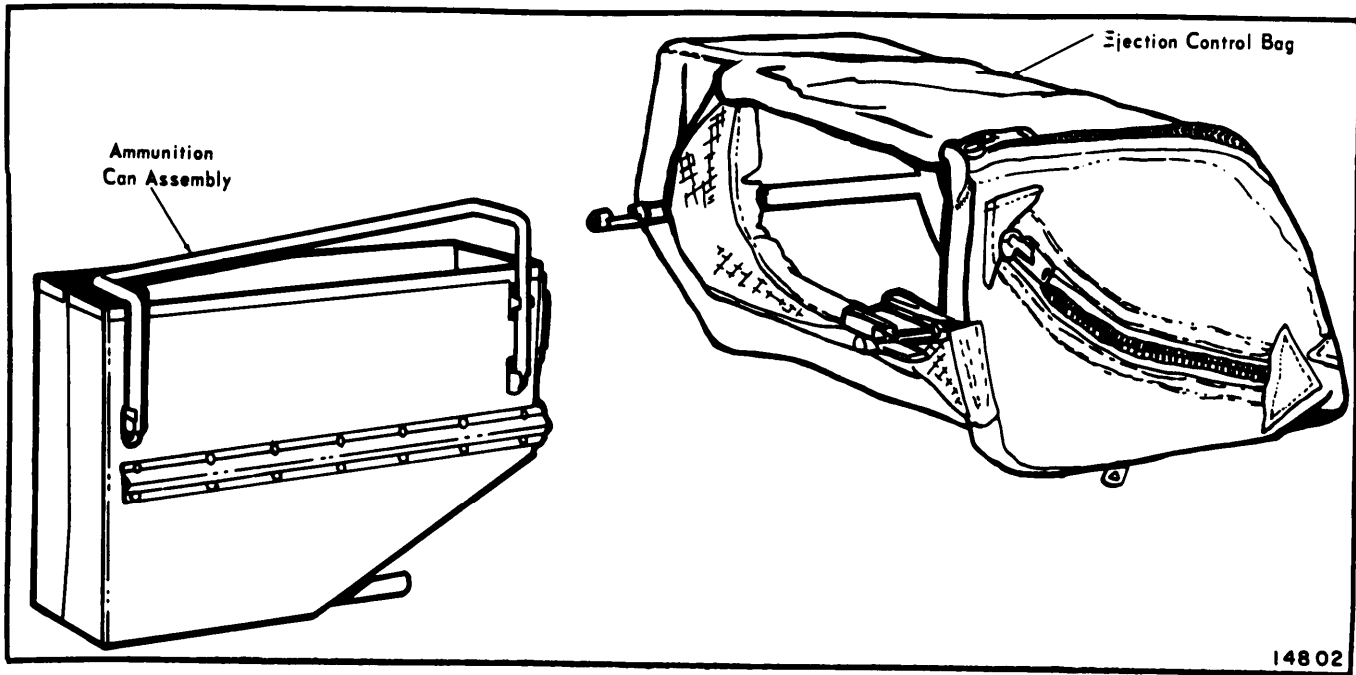


Figure 4-11. Ammunition Can and Ejection Control Bag

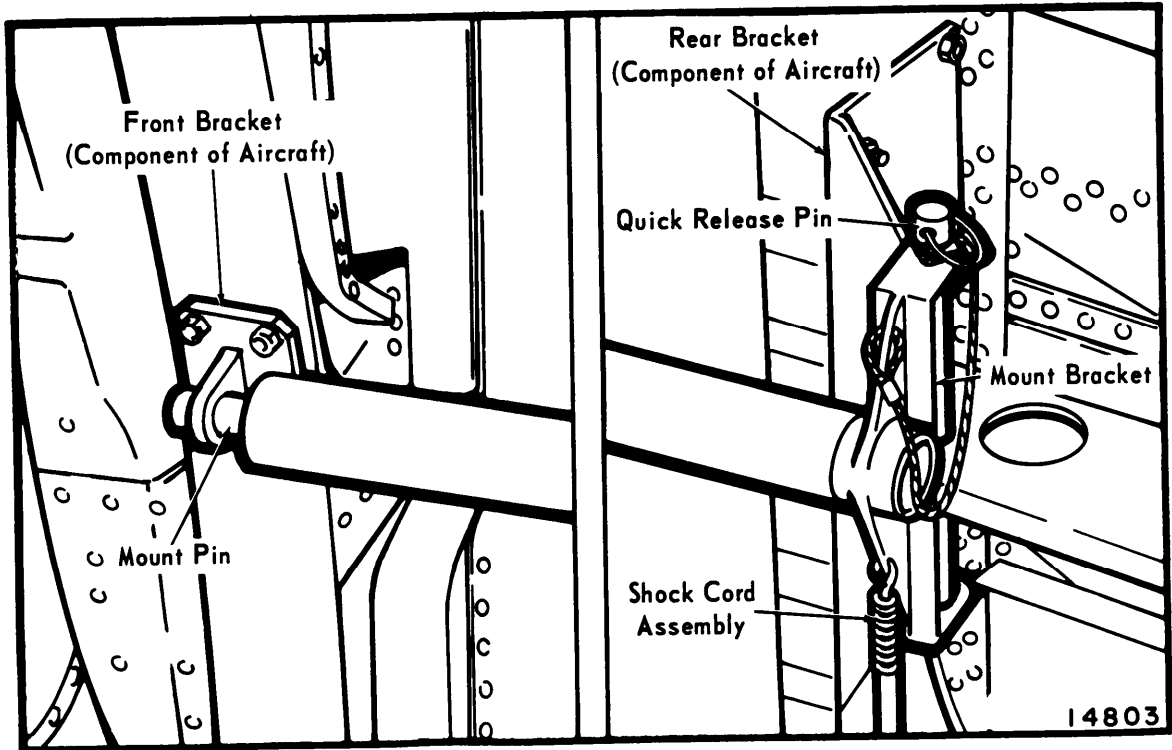


Figure 4-12. Right Machine Gun Mount - Installed

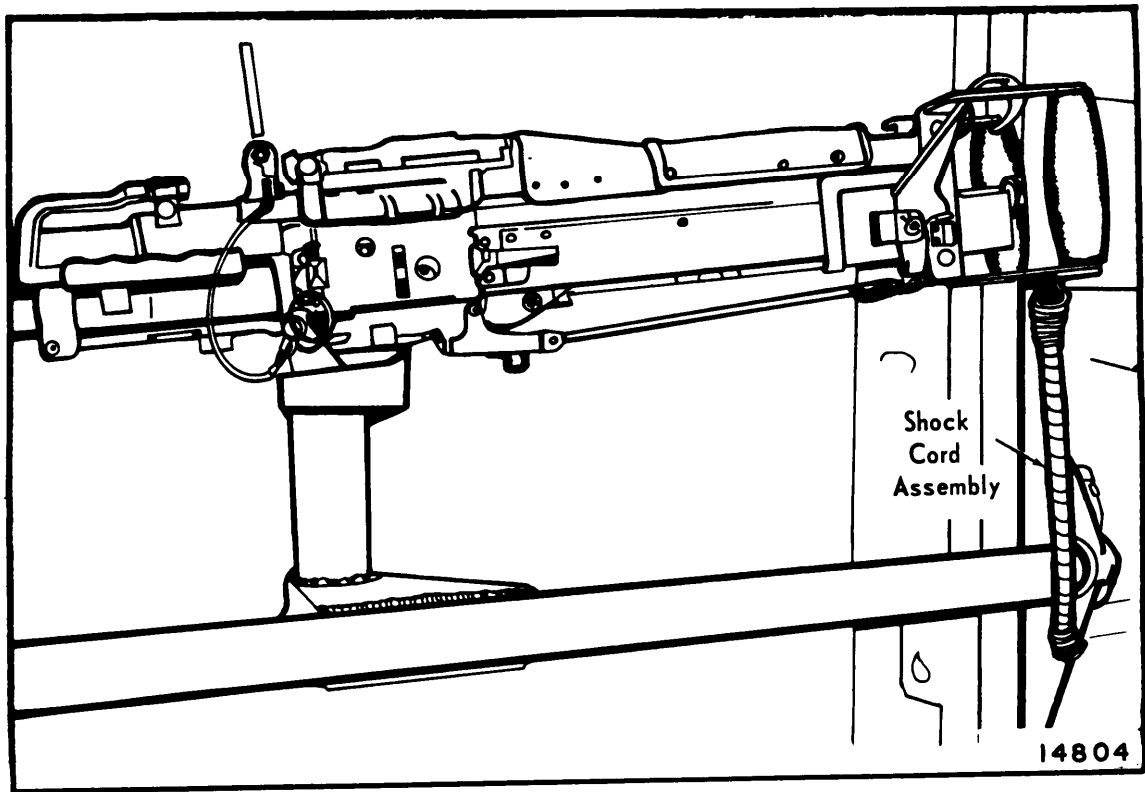


Figure 4-13. Machine Gun Stowed on Right Mount

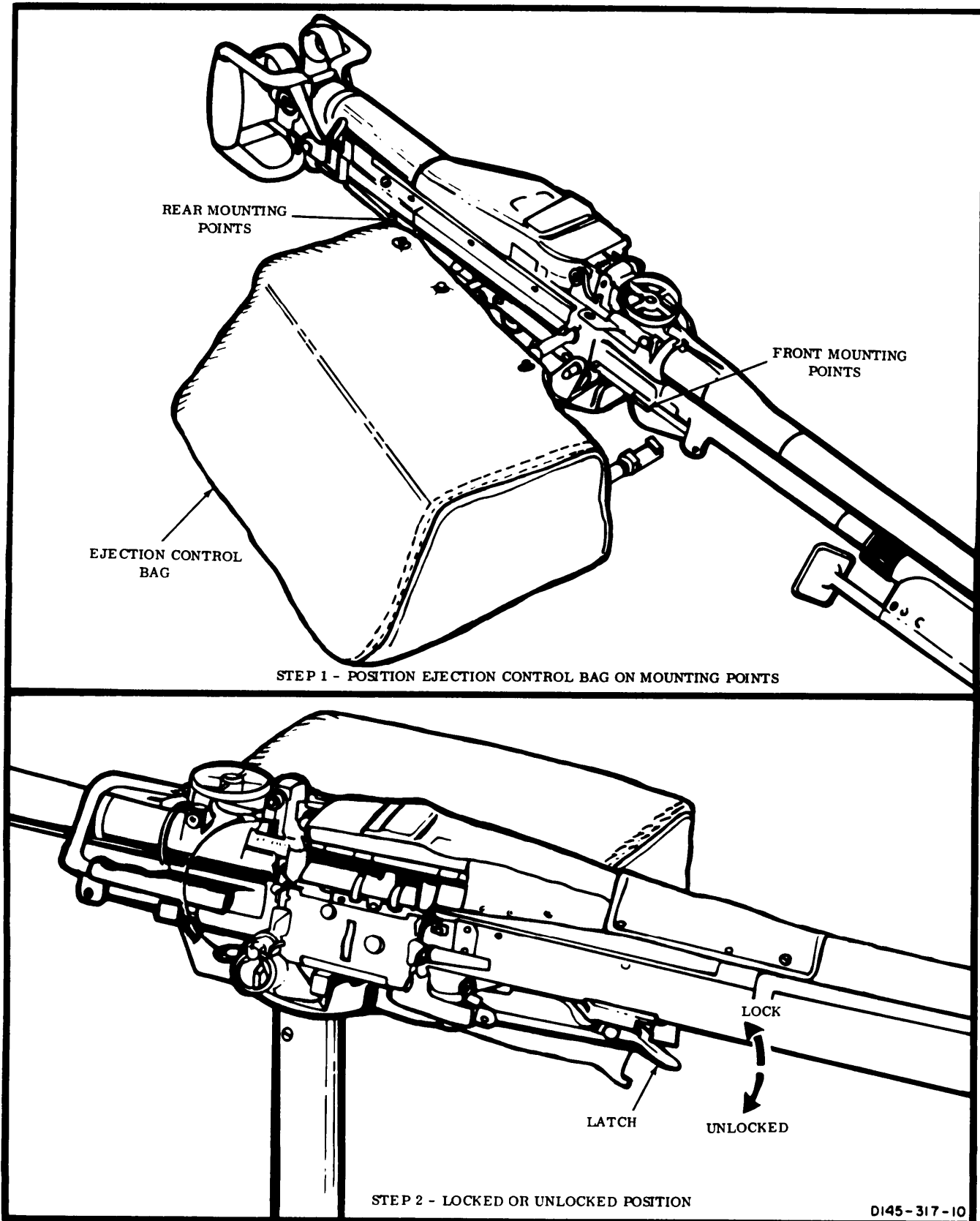


Figure 4-14. Ejection Control Bag - Installed

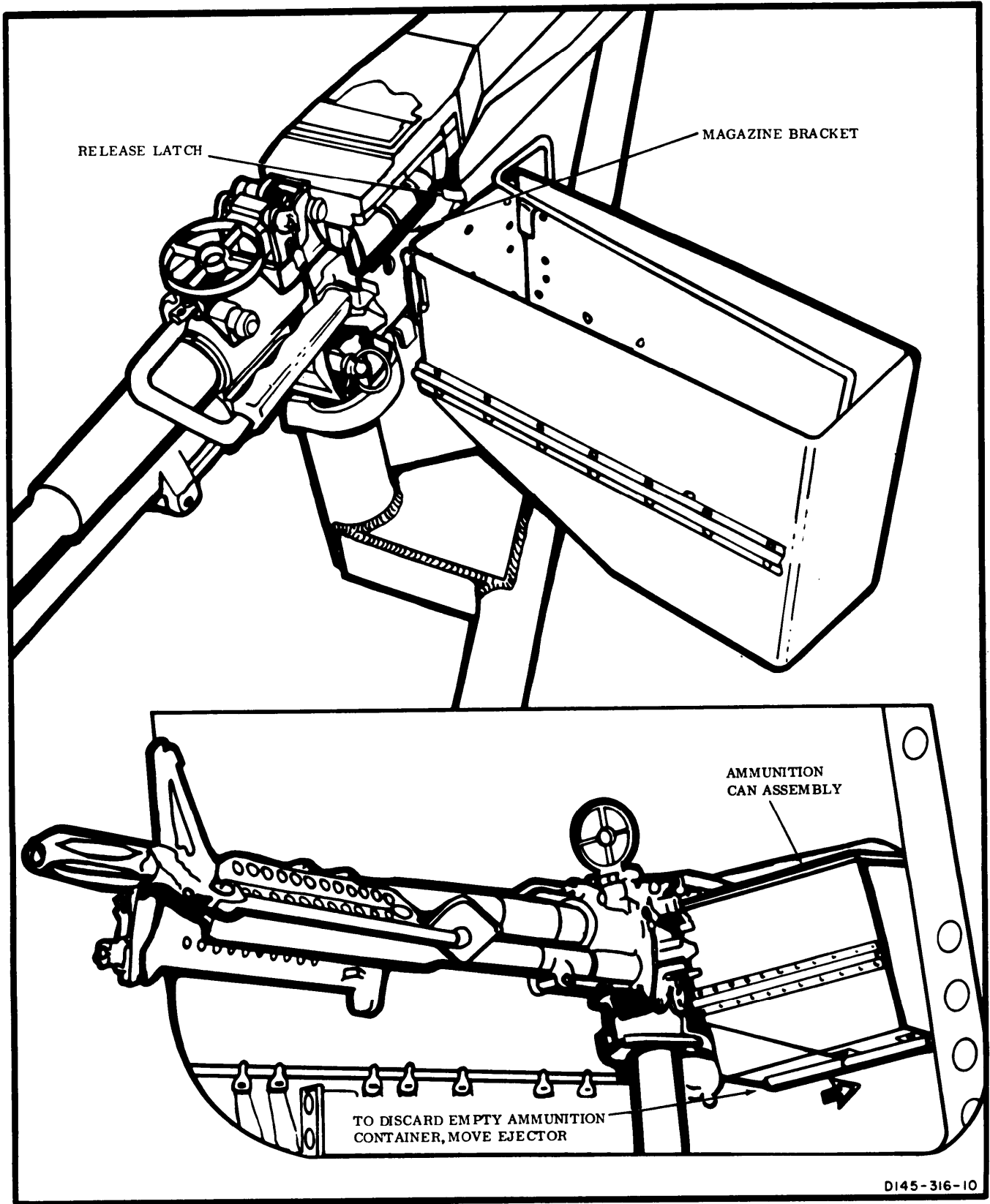


Figure 4-15. Ammunition Can - Installed

2. Firing.

With the machine gun loaded and aimed, push the safety button to fire (F) position. Because of the low rate of fire, single cartridges or short bursts can be fired. The trigger must be completely released for each shot to fire single cartridges or to interrupt firing. When the ammunition is exhausted, the last link will remain in the cartridge tray. Remove the link and the end plug by hand after the cover is opened for loading.

**CAUTION**

Do not fire the M24 machine guns unless the ejection control bags are installed. Failure to install the bags before firing the machine guns could cause the brass and links to be ejected overboard and ingested into the engines if engine screens are removed.

**CAUTION**

The M24 machine guns are not to be fired unless RRPM is at minimum beep or higher.

3. After Firing Operation.

- a. Push the safety button to safe (S) position, aim at safe area, and try to fire the machine gun.

- b. Retract the bolt by pulling the handle fully rearward until the sear engages and then push the handle to forward position. Move the cover latch rearward to the horizontal position and then raise the cover. Remove the linked cartridges.
- c. Inspect the chamber to be sure it is clear,
- d. Close the cover and secure the machine gun in stowed position.

**4-26. Ammunition.**

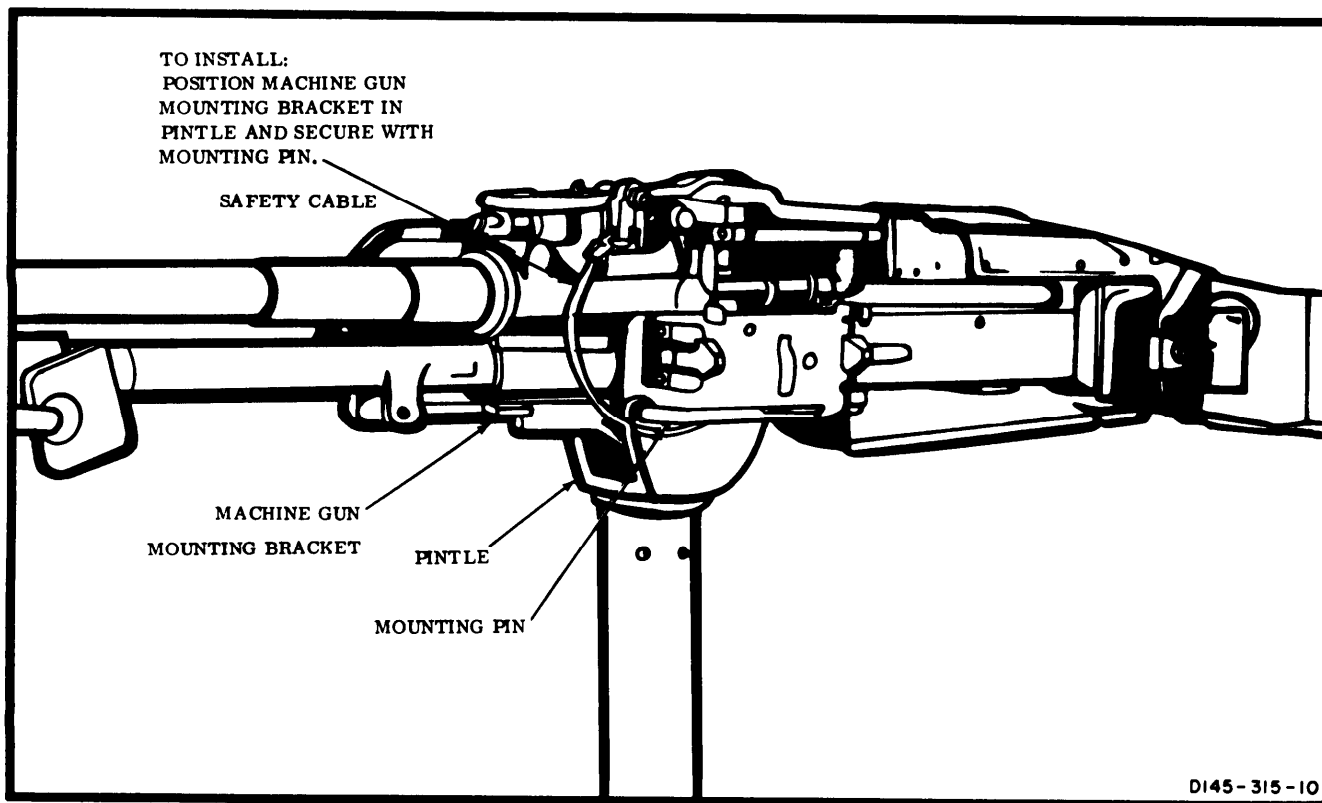
The M60D machine gun is used for both the M24 and M41 armament subsystems. The ammunition for 7.62 mm machine gun M60D is classified as small arms ammunition and is issued in linked belts. Issue is in proportion by types to meet tactical requirements (table 4-2).

**Table 4-2. Authorized Cartridges**

7.62-millimeter: AP, NATO M61
7.62-millimeter: Ball, NATO M59
7.62-millimeter: Ball, NATO M80
7.62-millimeter: Tracer, NATO M62
7.62-millimeter: Dummy, NATO M63

**4-27. ARMAMENT SUBSYSTEM M41.**

Armament subsystem M41 is installed at the rear edge of the ramp. The mount has a pintle and post with



**Figure 4-16. Machine Gun Positioned on Pintle – Left Side Shown**

limiting cam surfaces similar to those on armament subsystem M24 mount assembly. The machine gun, ammunition can, and ejection control bag are the same as those on armament subsystem M24.

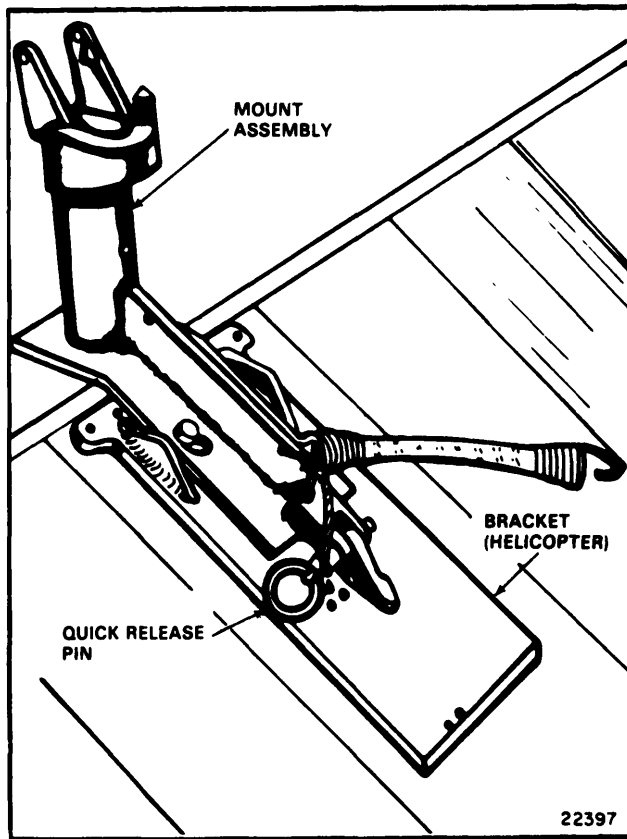


Figure 4-17. M41 Mount - Installed on Ramp

**4-28. Mount Assembly (M41).**

The mount is positioned on the lugs of the ramp bracket and is secured with a quick-release pin (fig. 4-17).

**NOTE**

If the bracket must be installed, be sure to center it along the rear edge of the loading ramp.

**4-29. Mount Assembly Stops, Cams, Quick-Release Pin, and Elastic Cord (M41).** The mount stops, cams, quick-release pin, and elastic cord have the following functions:

- a. Maximum traverse, elevation, and depression of the machine gun M60D are controlled by cam surfaces and stops on the pintle and the pintle post (table 4-3).
- b. The quick-release pin, attached by cable to the rear of the mount, secures the mount to the ramp (fig. 4-17).
- c. The elastic cord is fastened to the mount and the machine gun when holding it in a stowed position.

**Table 4-3. Armament Subsystem M41 Data**

Effective range	1100 meters (max)
Rate of fire	550-650 rnds per min.
Length, overall	44.875 in.
Sighting	Aircraft ring and post type
Total traversing capability	94°
Elevation	12°30'
Depression	69°

**4-30. Operation - Armament Subsystem M41.**

Operation of the armament subsystem M41 is the same as operation of the M24.

## SECTION III CARGO HANDLING SYSTEMS

### 4-31. Winch/Hoist System.

A 3,000-pound-capacity hydraulically operated winch (fig. 4-18) is mounted on the floor in the right forward cabin at sta 120. Hydraulic power cooperate the winch is supplied by the utility hydraulic system. The winch (fig. 4-19) has **150** feet of usable  $\frac{1}{4}$  inch cable. It is capable of winching up to **12,000** pounds of cargo with the aid of pulley blocks. When used in hoisting mode (fig. 4-26), the load is limited to **600** pounds. The winch has two maximum reeling speeds: one for cargo loading (**20 fpm**) and one for hoisting (**100 fpm**). When the winch is used for cargo loading, a selector control lever on the cable drum housing is moved to CARGO. When the winch is used for hoisting, the selector control lever is moved to RESCUE. A mechanical braking device automatically locks the cable drum when power is off, preventing loss of load control through cable payout. If the winch cable load exceeds **3,200 pounds**, an overload switch will automatically stop the winch. The free end of the winch cable is equipped with a metal ball which locks into one end of a quick-disconnect device that is used to attach hooks to the cable. Both ends of the cable are painted red for **20** feet to alert the operator that the cable end is approaching. In CARGO mode, the winch will automatically stop when the cable is reeled out **150** feet, and at **3** feet when the cable is reeled in. In RESCUE mode, the winch will stop when the cable is reeled out **150** feet and at **28.5** feet when the cable is reeled in.

### 4-32. Winch Controls.

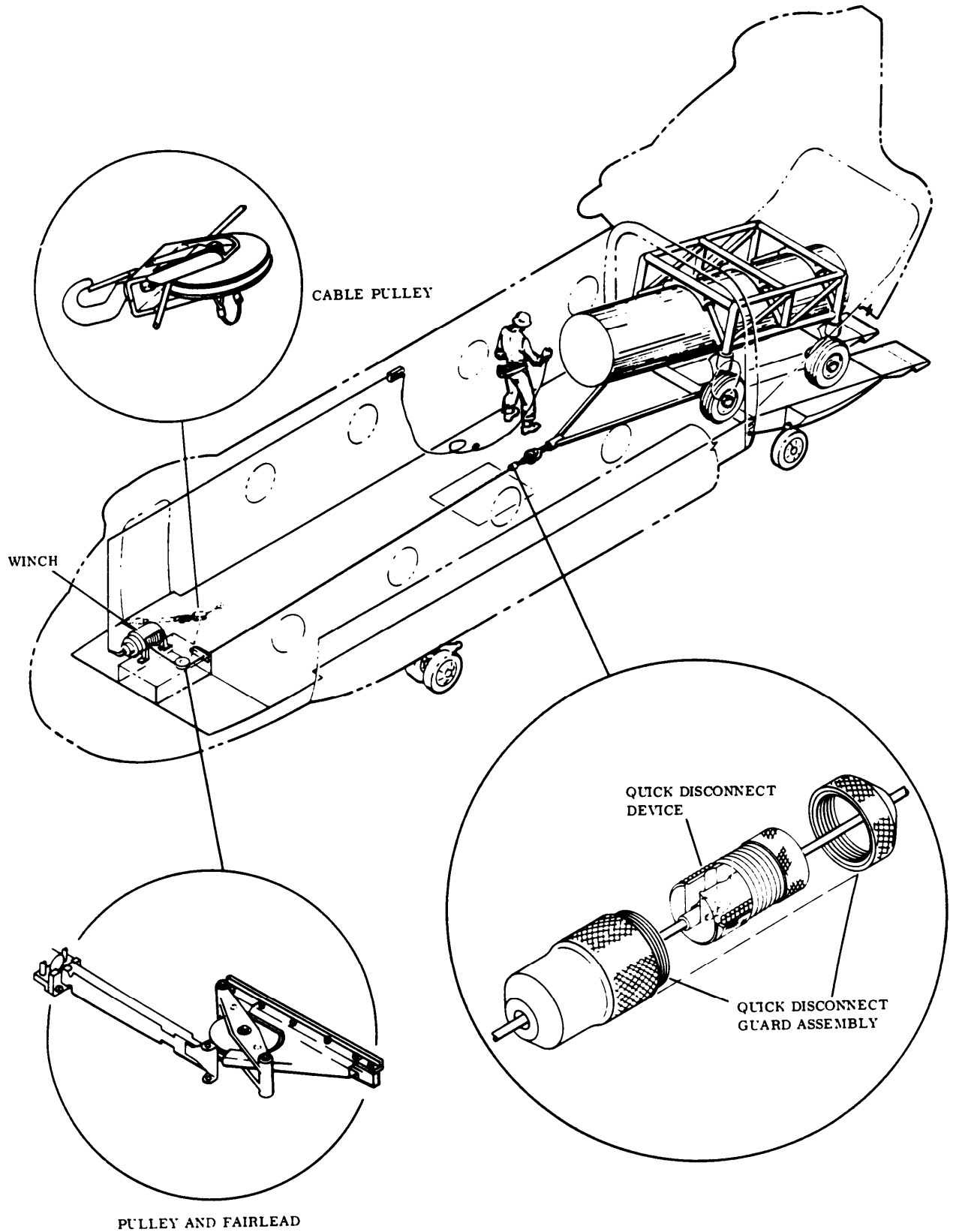
The winch can be controlled from the cockpit by switches on the overhead switch panel (fig. 4-20) or from the cargo compartment by switches on the winch/hoist control grip. The switches in the cockpit override the switches on the control grip, enabling the pilot to assume control of hoisting operations in an emergency. When operating from the cargo compartment, the winch-hoist control grip can be plugged into a receptacle on the auxiliary control panel (fig. 4-21) at sta 95, the hoist operators panel at sta 320 (fig. 4-25), or the receptacle at sta 502 (fig. 4-22) by an extension cord. The winch can also be manually operated from the cabin. These controls are for emergency use only. The controls are mounted on the structure in the heater compartment. Instructions for manual operation of the winch are on the structure above the control valves and instructions in this section. Electrical power to operate and control the winch is supplied by the 28-volt No. 1 DC bus through two circuit breakers on the No. 1 PDP. These two circuit breakers are marked HOIST CABLE CUTTER and HOIST CONT.

### NOTE

The cable cutter arming device must be plugged into the receptacle on the auxiliary control panel at sta 95 (fig. 4-21) and the cable speed selector lever must be at CARGO to complete the winch control circuit for cargo operations. The cable cutter arming device must be plugged into the receptacle on the overhead above the utility hatch (fig. 4-23) and the cable speed selector lever must be at RESCUE to complete the hoist control circuit for hoisting operations.

- a. Winch control switches (overhead switch panel).
  - (1) Hoist master switch. A toggle hoist master switch is on the hoist control panel (fig. 4-20). The switch (labeled HOIST MSTR) has positions marked REMOTE, OFF, and PLT. When the switch is at REMOTE, electrical power from the 28-volt No. 1 DC bus, through the HOIST CONT circuit breaker, energizes the winch arming switch on the winch/hoist control grip. Once this switch is pressed, the winch cable switch, also on the grip, is energized, allowing the winch reeling speed to be controlled at the hoist operator's station. When the master switch is at PLT, electrical power energizes the hoist control switch on the overhead switch panel, which gives the pilot control of the hoisting system. When the switch is at OFF, power is removed from the hoist control switches at both stations.
  - (2) Hoist control switch. A spring-loaded, rheostat-type switch is provided for hoist control and is on the hoist control panel. The switch (labeled HOIST) has positions marked OFF, IN, and OUT. When the hoist master switch is at PLT, electrical power, from the 28-volt No. 1 DC bus through the HOIST CONT circuit breaker, energizes the hoist control switch. Then the switch is moved to IN or OUT, the hoist brake release solenoid valve is energized open. The open valve applies hydraulic pressure through the hoist control valve to the winch to turn the cable drum in the appropriate direction. The speed of the cable is proportional to hoist control switch movement. When the switch is released, the switch assumes the center OFF position. In addition, the brake release solenoid valve is deenergized closed, which removes hydraulic pressure to brake the cable drum.
  - (3) Cable cutter switch. A cable cutter switch is on the left side of the hoist control panel. The guarded switch (labeled CABLE CUT) has

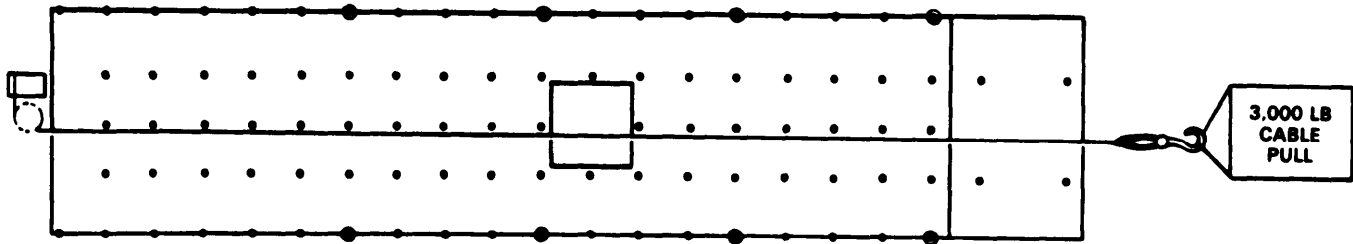




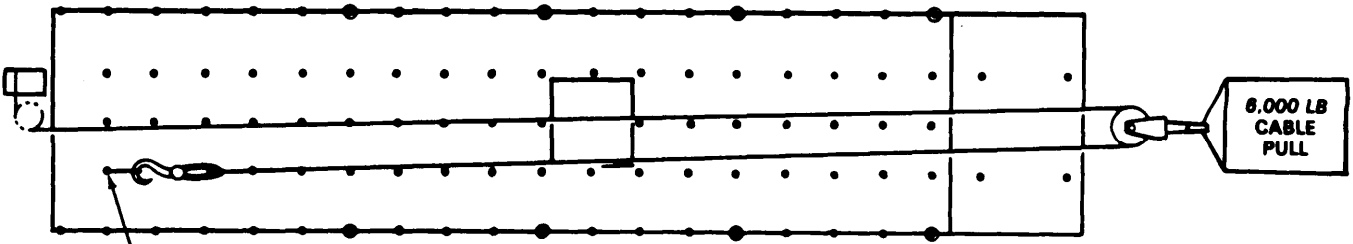
D145-128-10

Figure 4-18. Winching System

**WINCHING IN**

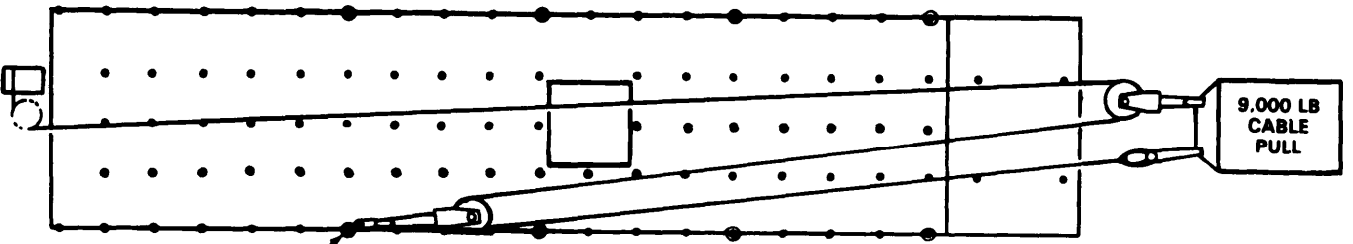


**3,000 LB  
CABLE  
PULL**



**6,000 LB  
CABLE  
PULL**

**ATTACH THE HOOK TO THIS 5,000 LB  
TIEDOWN FITTING (STATION 140.00)**



**9,000 LB  
CABLE  
PULL**

**ATTACH THE PULLEY TO THIS 10,000 LB  
TIEDOWN FITTING (STATION 240.00)**

**NOTE**

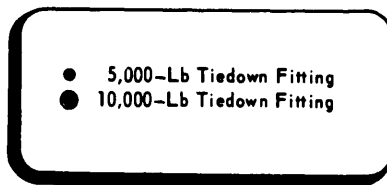
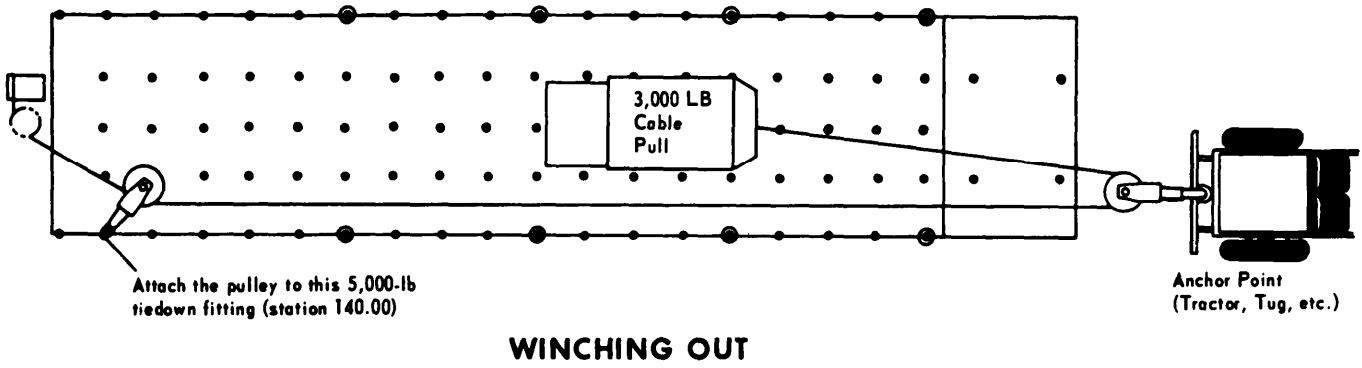
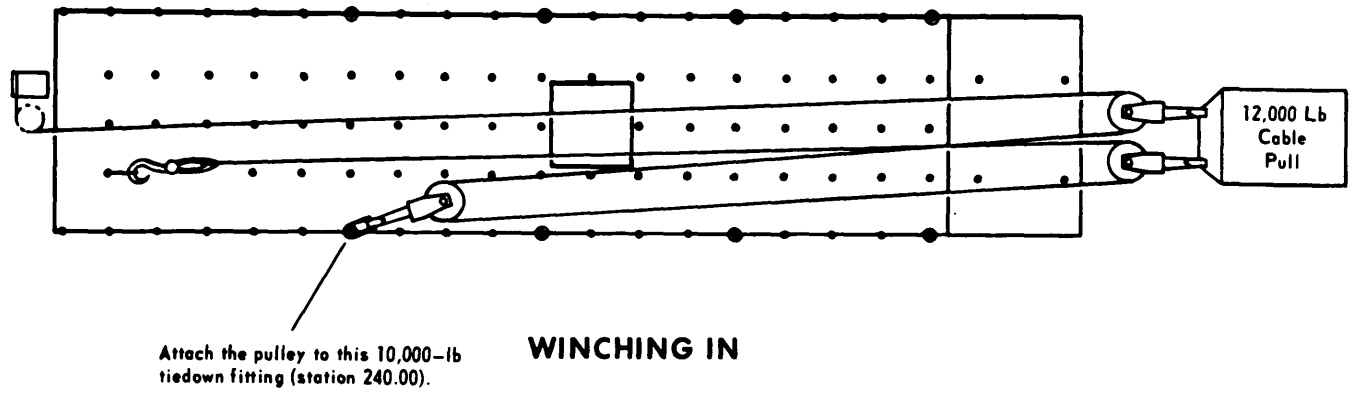
WHEN THE LOAD TO BE WINCHED IS RESTING ON THE HICHS ROLLERS, THERE IS NO REQUIREMENT TO USE PULLEYS. ENSURE THAT THE PULLEY NEXT TO THE WINCH MOTOR IS INSTALLED JUST FORWARD OF STATION 120, RIGHT HAND SIDE OF THE AIRCRAFT.

**NOTE**

THE CABLE SPEED WHEN WINCHING IS 20 FEET PER MINUTE; HOWEVER THE LOAD WILL MOVE AT THE FOLLOWING RATES:  
3,000 LB — 20 FEET PER MINUTE. 6,000 LB — 10 FEET PER MINUTE. 9,000 LB — 6.6 FEET PER MINUTE, AND 12,000 LB — 5 FEET PER MINUTE.

22386

*Figure 4- 19. Winch Capabilities (Sheet 1 of 2)*



14808

Figure 4-19. Winch Capabilities (Sheet 2 of 2)

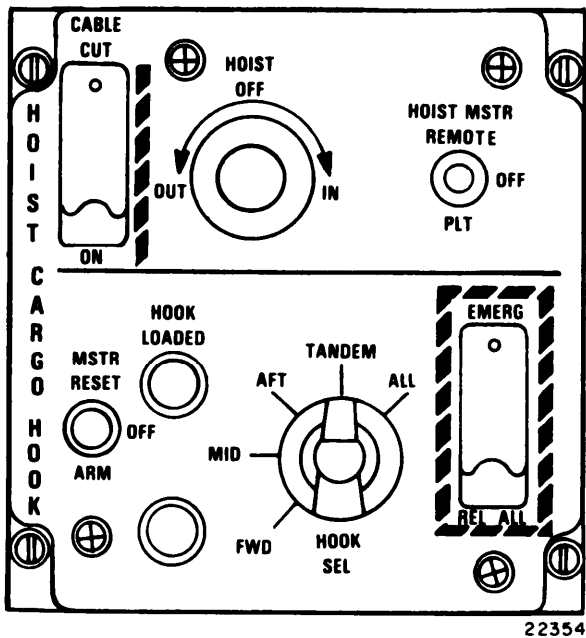


Figure 4-20. Hoist Control Panel

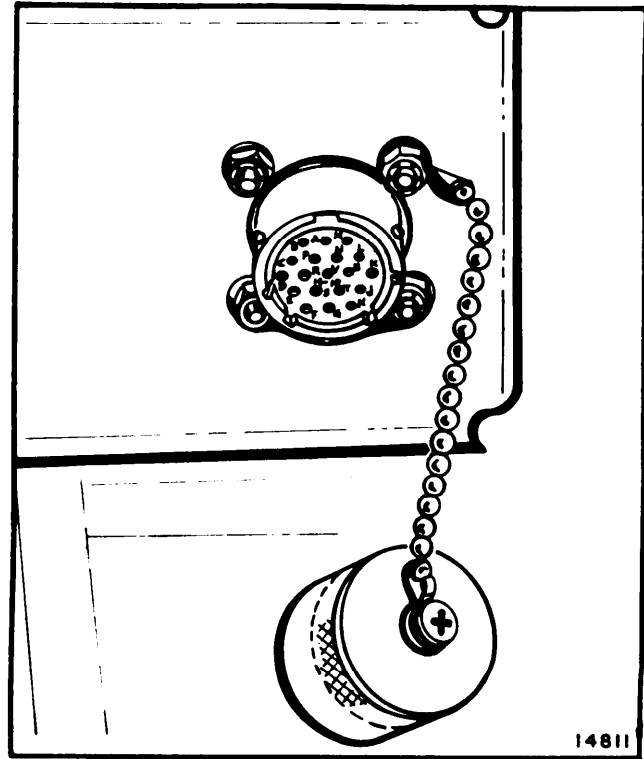


Figure 4-22. Winching Receptacle (Station 502)

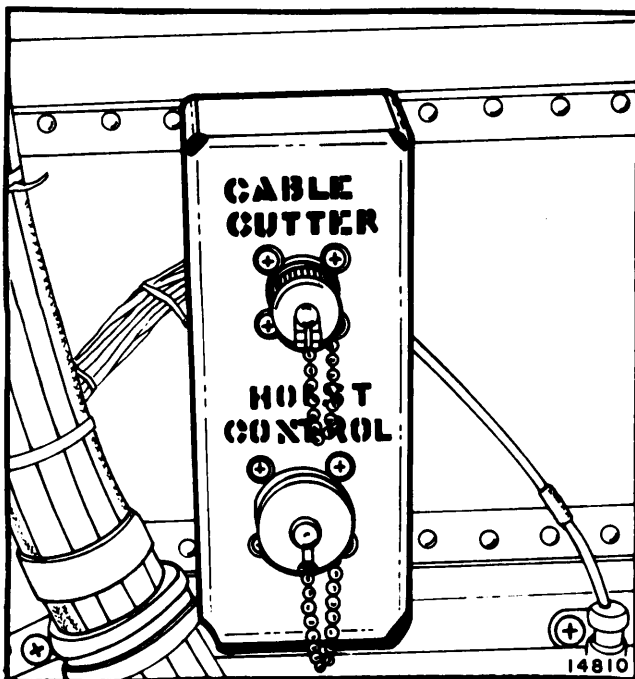


Figure 4-21. Auxiliary Control Panel (Station 95)

positions marked ON and OFF. When the switch is at ON, electrical power from the 28-volt No. 1 DC bus, through the CABLE CUTTER circuit breaker, detonates a ballistic cartridge in the cable cutter which cuts the

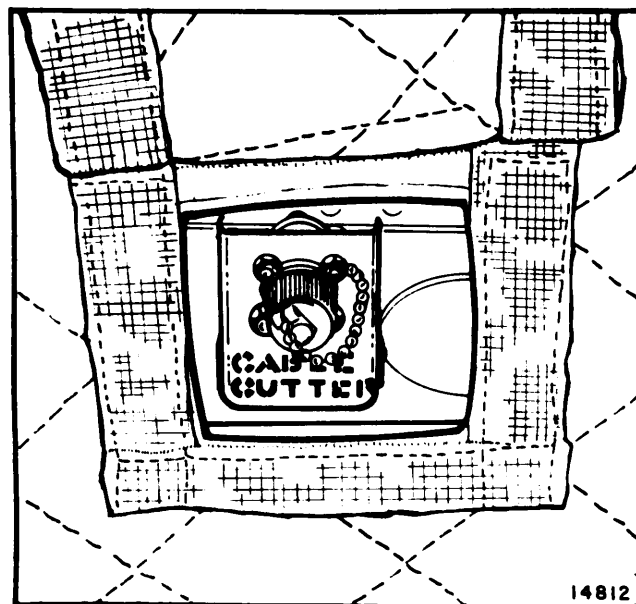


Figure 4-23. Overhead Cable Cutter Receptacle

cable. When the switch is at OFF, the cable cutter circuit is deenergized.

- b. Winch control switches (fig. 4-24). A portable pistol-shaped control grip contains a built-in microphone switch and a number of other switches

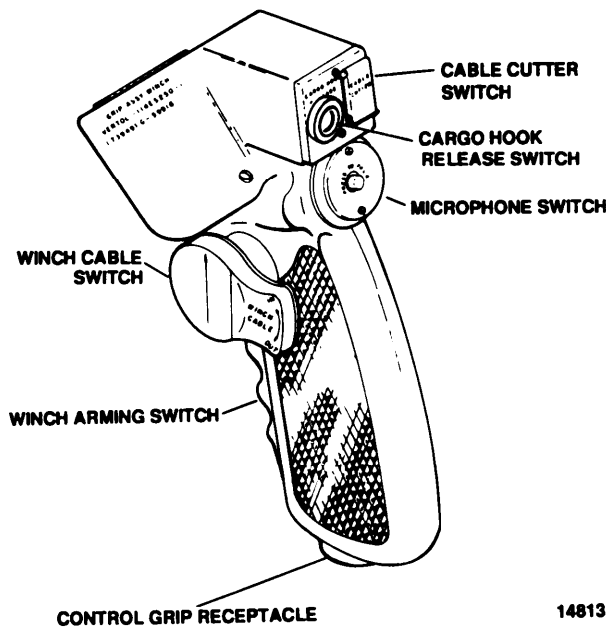


Figure 4-24. Winch/Hoist Control Grip

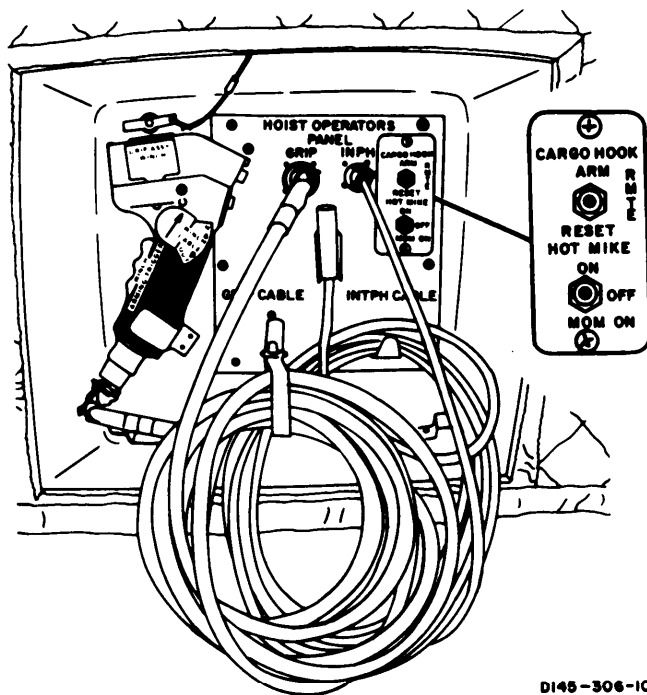


Figure 4-25. Hoist operators Panel (Station 320)

used in hoisting, winching, and cargo hook operations. A receptacle for plugging in the extension cord cord is in the butt end of the grip. A hook extending from the side of the grip is used to hang the grip in its stowed position on the hoist control panel. The switches contained in the grip are as follows:

- (1) Winch arming switch. The winch is armed for use by a trigger-type, spring-loaded switch. When the switch is pressed, a circuit closes, arming the control circuits of the winch hydraulic motor. When the switch is released, the circuit opens, rendering the winch inoperable.

**NOTE**

The winch arming switch must be pressed to operate the winch.

- (2) Winch cable switch. Winch cable reeling is controlled by a rotary switch on the left side of the control grip. Action markings around the switch are IN, OFF, and OUT. The switch is spring-loaded to center OFF position. When the switch is moved to IN or OUT, a selector valve in the winch hydraulic system is electrically actuated, providing hydraulic pressure to turn the cable drum. The speed of the cable is proportional to cable switch movement in either direction.
- (3) Cable cutter switch. A pushbutton switch on the upper shoulder of the control grip actuates the cable cutter. A metal guard marked CABLE CUTTER prevents accidental closing of the switch. When pressed, the switch closes a circuit, providing electrical current to fire a ballistic cartridge in the cable cutter. The firing propels a cutter which cuts the cable.
- (4) A cargo hook release switch.
- (5) Microphone switch.

**CAUTION**

When using the microphone switch on the hoist control grip, be careful not to press the cargo hook switch.

**4-33. Winch Operation.**

With hydraulic and electrical power available, the winch can be operated from the cockpit or from the cargo compartment, in either the cargo mode (for winching cargo into the cargo compartment via the ramp) or in the rescue mode (for rescue or hoisting small cargo through the rescue hatch).

- a. Control settings and electrical connections for operating the winch in the **cargo** mode from the cockpit are as follows:
  - (1) Cable speed selector lever on the winch – CARGO.
  - (2) Cable cutter arming device (or adapter cable, pig-tail) – Plugged into the auxiliary control panel, in the heater compartment at sta 95.
  - (3) Hoist master switch on the cockpit overhead panel – PLT.

- (4) Hoist control switch on cockpit overhead panel – OUT, OFF, or IN as required to control direction and speed of cable.
- b. Control settings and electrical connections for operating the winch in the cargo mode from the cargo compartment are as follows:
  - (1) Cable speed selector lever on the winch – CARGO.
  - (2) Cable cutter arming device (or adapter cable, pig-tail) – Plugged into the auxiliary control panel, in the heater compartment at sta 95.
  - (3) Hoist master switch on the cockpit overhead panel – REMOTE.
  - (4) Winch/hoist control grip – Plugged into either the auxiliary control panel in the heater compartment, sta 95, the hoist control panel, right side sta 320, or the receptacle, left side sta 502.
  - (5) Winch arming switch on the winch/hoist control grip – Depress.
  - (6) Winch cable switch on the winch/hoist control grip – OUT, OFF, or IN as required to control direction and speed of winch cable.
- c. Control settings and electrical connections for operating the winch in the **rescue** mode from the cockpit are as follows:
  - (1) Cable speed selector lever on the winch – RESCUE.
  - (2) Cable cutter arming device – Plugged into the overhead receptacle above the rescue hatch.
  - (3) Hoist master switch on the cockpit overhead panel – PLT.
  - (4) Hoist cable switch on the cockpit overhead panel – OUT, OFF, or IN as required to control the direction and speed of the winch cable.
- d. Control settings and electrical connections for operating the winch in the rescue mode from the cargo compartment are as follows:
  - (1) Cable speed selector lever on the winch – RESCUE.
  - (2) Cable cutter arming device – Plugged into the overhead receptacle above the rescue hatch.
  - (3) Hoist master switch on cockpit overhead panel – REMOTE.
  - (4) Winch/hoist control grip – Plugged into the receptacle on the hoist control panel, right side, sta 320.

- (5) Winch arming switch on the winch/hoist control grip – Depress.
- (6) Winch cable switch on the winch/hoist control grip – OUT, OFF, or IN as required to control direction and speed of the winch cable.
- e. Rigging and operating procedures for use of the winch in the cargo mode are as follows:
  - (1) Using the hoist control switch on the cockpit overhead panel or on the winch/hoist control grip – reel out the winch cable as required for rigging. As the cable is being reeled out, a crewman should maintain tension on the cable to avoid snarling and kinking. After the cable is extended, the usable cable length will be checked to ensure that the cable is free of any broken strands or definite bends that may reduce the cable capability.

**CAUTION**

**Do not exceed 3,000 pounds single line pull. Overload will result in the winch overload switch actuating to stop the winch.**

- (2) Remove the pulley from the pulley blocks by removing the quick-release pins. Reeve the cable through pulley as required to provide the required pull and angle of entry (fig. 4-26 (Sheet 1 of 2)) for rigging configurations for various loads. Install the pulley blocks and secure them with the quick-release pins.

**WARNING**

**The cable quick-disconnect cover guard must be installed during all cargo operations. Otherwise, the hook assembly can be inadvertently disconnected from the winch cable which can result in serious injury to personnel.**

- (3) Attach the winch cable to the cable hook assembly by depressing the lock rings on each end of the quick-disconnect device, inserting the ball ends of the winch and hook assembly cables into the quick-disconnect device and releasing the lock rings. Install the quick-disconnect cover guard.
- (4) Attach the winch cable to the load.

**WARNING**

**Personnel not required for the winching operation must remain well clear of the winch cable to prevent possible injury should the cable break.**

**CAUTION**

Slack must be removed from the cable train before applying the fill load to the winch system to prevent shock and overload of the system.

- (5) Reel the cable in slowly until all slack in the cable is removed. Then winch the load into the cargo compartment to the desired position.

**WARNING**

Chock vehicles and wheeled cargo before disengaging cable hook. Injuries to personnel can result from uncontrolled rolling of the load.

- (6) Reel out the cable slowly to provide slack in the cable. The hook can either be left attached to the load or disconnected. If the hook is disconnected, it should be attached to a tiedown fitting to prevent in-flight vibrations damage to the cargo floor.
- f. Rigging and operating procedures for use of the winch in the rescue mode are as follows:

**NOTE**

The cargo hook assembly must be removed from the rescue hatch.

- (1) Using the hoist control switch on either the cockpit overhead panel or on the winch/hoist control grip, reel out the winch cable as required for rigging. As the cable is being reeled out, a crewman should maintain tension on the cable to avoid snarling and kinking. After the cable is extended, the usable cable length will be checked to ensure that the cable is free of broken strands or definite bends that may reduce the cable capability.

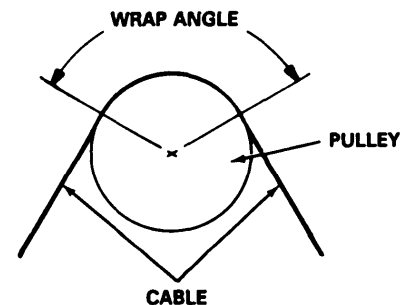
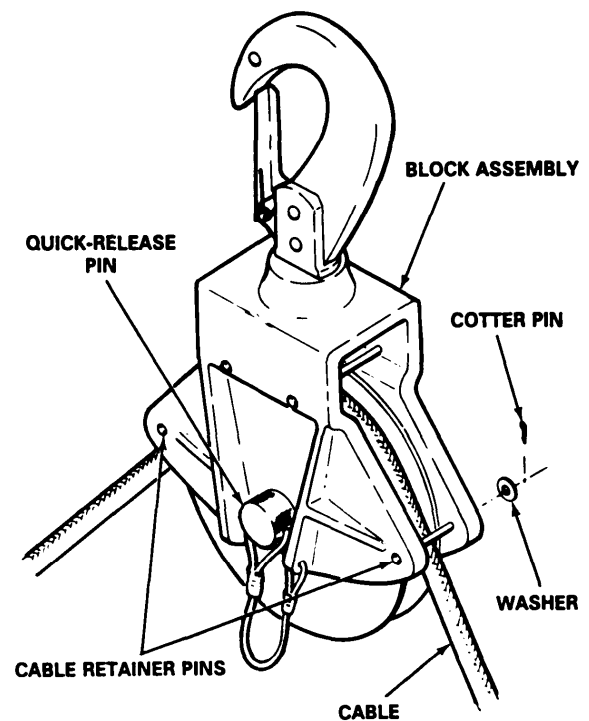
**CAUTION**

Some pulley block assemblies have flanges with cable retainer pins as shown in fig. 4-26 (Sheet 1 of 2). These pins should be installed only if the cable makes a wrap angle of 180° or more around the pulley. Otherwise, the cable will bind on the pins and overload the winch and cable. When not in use, the pins and attaching hardware should be stowed in the container provided for the hoist accessories.

- (2) Install the pulley block assembly on the floor at sta 140, the overhead on the aft face of sta 120 bulkhead and the cable cutter pulley

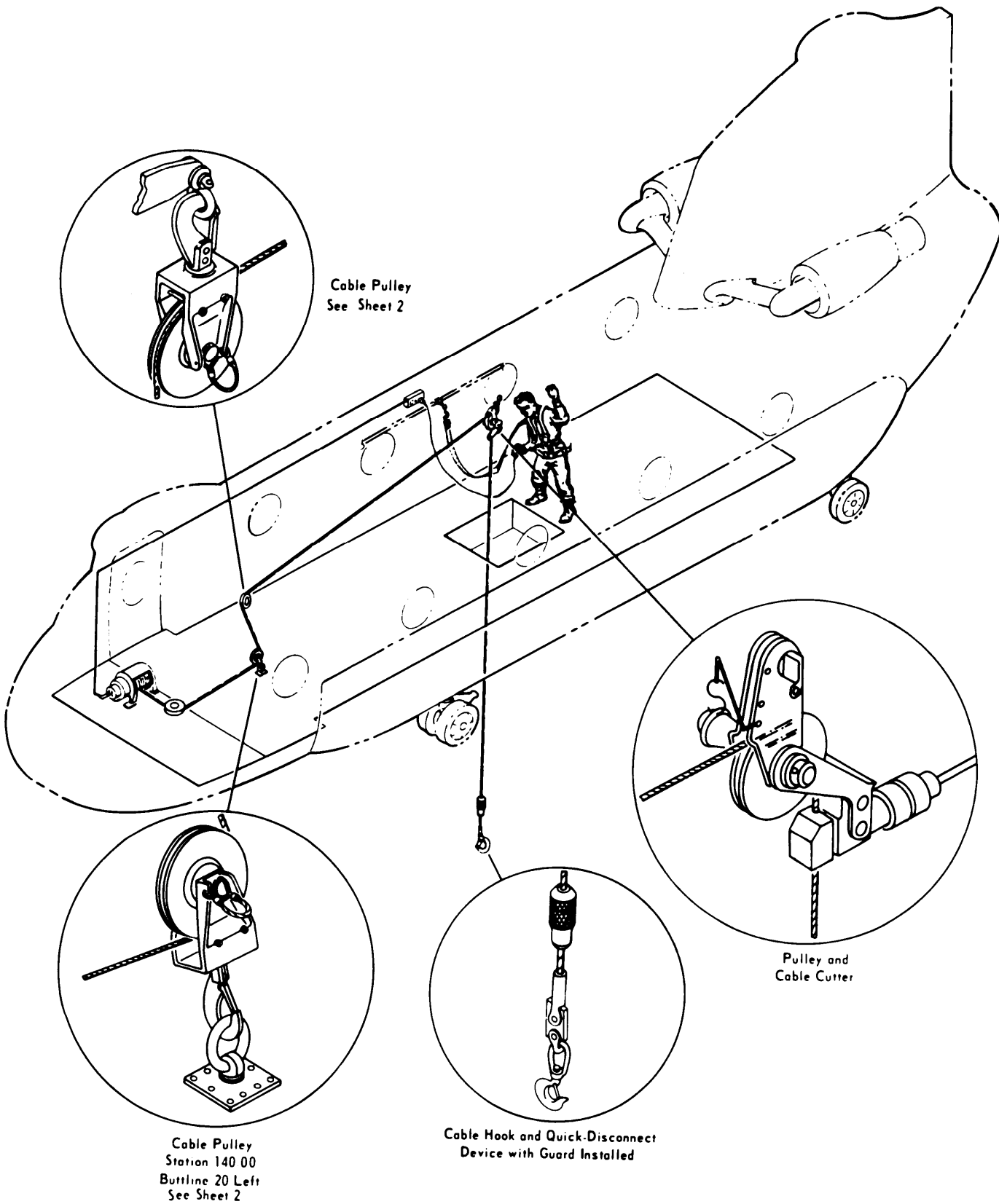
block over the rescue hatch (fig. 4-26 (Sheet 2 of 2)).

- (3) Reeve the cable through the pulley at each location by first removing the quick-release pin, removing the pulley and positioning the cable over the pulley. Reinstall each pulley and secure with the quick-release pin (fig. 4-26 (Sheet 1 of 2)).



24945

Figure 4-26. Hoisting System (Sheet 1 of 2)



14815

Figure 4-26. Hoisting System (Sheet 2 of 2)



**WARNING**

The quick-disconnect cover guard must be installed during rescue and cargo operations. Otherwise, the hook assembly can be inadvertently disconnected from the winch cable which can result in loss of life or the load or serious injury to operating personnel. For personnel rescue, the cable must touch the ground or water prior to touching personnel or a dangerous static electrical shock may result.

- (4) Attach the winch cable to the cable hook assembly by depressing the lock rings on each end of the quick-disconnect device, inserting the ball ends of the winch and hook assembly cables into the quick-disconnect device and releasing the lock rings. Install the quick-disconnect cover guard.

**WARNING**

Slack must be removed from the cable train before applying the full load to the winch system to prevent shock and overload of the system and possible injury to the personnel being hoisted.

**CAUTION**

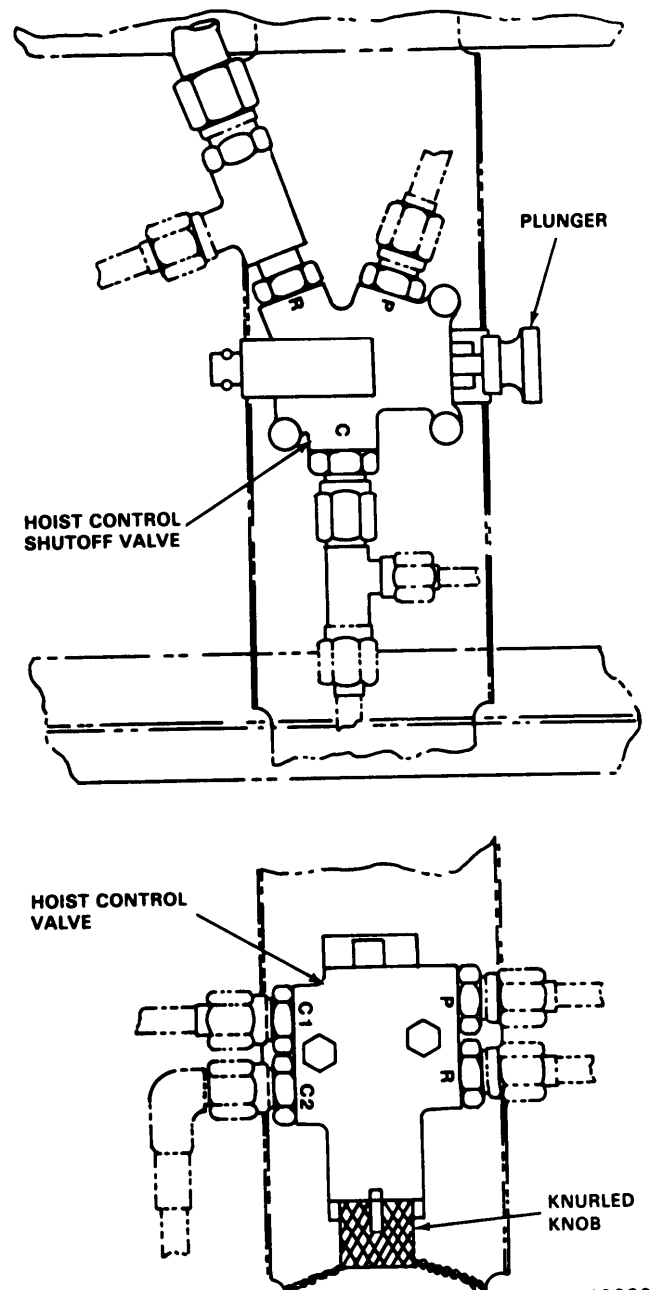
Ensure that the load is clear of the ground and all obstacles before proceeding from hover to forward flight. Do not exceed 600 pounds. An overload can result in damage or failure of the support structure for the overhead cable pulley.

- (5) Reel the cable out and attach the cable hook to load - Reel in or out as required.
- g. When electrical power to the winch is not available, the winch may be operated in emergency mode as follows:

**CAUTION**

When the winch is operated in emergency mode, the cable limit switches are disabled. To avoid kinking the cable stop the winch when there is no less than 3 turns of cable on the drum. Stop reeling the cable in when the quick-disconnect guard assembly contacts the pulley and fairlead (fig. 4-18).

- (1) Remove electrical connectors from the hoist control valve and hoist control shutoff valve on the left bulkhead of the heater compartment (fig. 4-27).



**Figure 4-27. Hoist Control Valve and Hoist Control Shutoff Valve**

- (2) Break the shear wire on the knurled knob of the hoist control valve.
- (3) Push in the plunger on the hoist control shutoff valve and rotate it 90 degrees to lock the valve open.
- (4) Turn the knurled knob on the hoist control valve clockwise to reel the cable out or counterclockwise to reel it in. Return the knob to the center (detent) position to stop the winch.
- (5) When use of the winch is completed, turn the plunger on the hoist control shutoff valve to unlock and extend it.

#### 4-34. Winching Accessories.

Accessories are provided for winching and hoisting operations. Employment of these accessories is determined by winch usage. A compartment bag is attached to the bulkhead wall above the winch for stowage of winching accessories.

a. *Cable Pulleys.* A sufficient number of pulleys are provided to permit routing the winch cable for winching and hoisting operations. The pulleys are equipped with snap-lock fasteners for attachment to tiedown fittings or shackles as required.

b. *Cable Hook.* A 2-ton-capacity removable hook is provided for use in winching and hoisting operations. Extending from the hook is a length of  $\frac{1}{4}$  inch cable, equipped with a metal ball which locks into a quick-disconnect device that is used for attaching the hook to the cable. The full-swiveling hook contains a spring snap lock to prevent opening of the hook and accidental loss of cargo.

c. *Quick-Disconnect Device.* The quick-disconnect device permits rapid connecting and disconnecting of winch cable hooks. The device consists of a short length of steel with socket cavities at each end. The sockets are enclosed by spring-loaded rings that rest against flared rims on either edge of the device. The lockrings are depressed to admit the ball ends of the cables into the sockets and snap into place when released, securing the ball ends of the cables in a positive connection. A guard is supplied with the quick-disconnect device. When installed, it prevents the hoist operator from inadvertently operating the quick-disconnect device when assisting a rescued person into the helicopter.

d. *Cable Cutter.* In hoisting operations, there is always a possibility that the cable hook might snag, resulting in critical strain on the hoisting system and restriction of helicopter mobility. The cable cutter provides a means of quickly severing the snagged hook by cutting the cable. The cable cutter consists of a housing, two follower rollers that permit free travel of cable through the housing, a cutting shell, a ballistic cartridge, and a threaded receptacle for an electrical connector. The cutter housing is split to allow reeving the cable and is bolted to a pulley bracket through two holes in the housing. The cable cutter is armed by coupling an arming device to the receptacle in the cutter housing and plugging the device into the receptacle above the

utility hatch marked CABLE CUTTER. The cable cutter cartridge is to be checked for total time prior to any hoisting or rescue operations. The cartridge should not be used after 8 years from date of manufacture and should also be replaced after 1 year of installed service life. Cartridges are considered over age when either limit is exceeded.

#### **WARNING**

**If personnel are in the cargo compartment when a load is jettisoned, make sure that they remain aft of the rescue hatch and face away from the cable cutter. The hoist cable can whip forward when it is cut and particles can be ejected from the cable cutter.**

e. *Cable Cutter Arming Device.* The arming device consists of an electrical wiring harness with electrical connectors at either end. This device is used to arm the cable cutter during hoisting operations. A connector at one end of the device couples with the threaded receptacle in the cable cutter; the connector at the other end of the device plugs into a receptacle above the utility hatch and is labeled CABLE CUTTER.

f. *Extension Cord.* A 15-foot extension cord is provided to allow mobility of the winch or hoist operator. Electrical connectors at each end of the cord connect with receptacles in the winch control grip and in the hoist control panel. This cord is the only means of plugging in power to the switches on the control grip.

g. *Safety Harness.* A safety harness is provided for the hoist operator in operations involving the use of the rescue hatch. The harness permits complete freedom of movement while affording a measure of safety in preventing the wearer from falling through the door opening. The safety harness is attached to a fitting on the wall of the cargo compartment near the hoist control panel or a floor tiedown fitting.

#### 4-35. Hoisting System.

The hoisting system (fig. 4-26) is used for air rescue and for aerial loading of smaller general cargo through the utility hatch. The hoisting system differs from the winching system only in the manner in which the cable is reeved and the mode selected at the winch. Hoisting operations require the winch cable to be reeved overhead and the hoist load capacity to be limited to a maximum of 600 pounds. The winch cable hook is used for hoisting operations together with the cable cutter which provides for quick release of the paid out cable and hook in event of emergency. On those aircraft provided with pulley block assemblies having pins as shown in fig. 4-26 (Sheet 1 of 2), the following instructions apply: When the hoisting system is reeved as shown in fig. 4-26 (Sheet 2 of 2), the pins and their retaining hardware are to be installed only if the cable makes a wrap angle of 180° or more around the pulley. When not in use, the pins and their retaining hardware are to be stowed in the container provided for hoist accessories.

**WARNING**

To prevent dangerous electrical shock to personnel being hoisted, the cable must touch the ground or water prior to contacting personnel.

**4-36. Static Line Retriever.**

A static line retriever is provided with the static line anchor cable (fig. 4-28). The retriever is used to haul static lines into the helicopter at the completion of a paratrooper mission and can also be used to haul in a paratrooper *hung up* on a static line. The static line anchor cable and retriever are installed and operated as follows:

- a. Install the anchor cable between sta 120 and 592.

**NOTE**

Do not allow the cable to sag more than 6 inches.

- b. Plug the cable cutter into the auxiliary control panel at sta 95 and move the speed selector on the winch to CARGO.
- c. Plug the winch control grip into the power receptacle at sta 502 on the left side.
- d. Reeve the winch cable through a pulley attached to a 5,000-pound tiedown fitting at sta 140, buttline 20 left and then through another pulley attached at sta 120, buttline 18 left (fig. 4-28).
- e. Reel out enough cable to allow the cable to rest on the floor and out of the way of personnel. Attach a quick-disconnect and cover guard to the winch cable.
- f. When the static lines are ready to be retrieved, reel out additional cable and attach the retriever to the winch cable. Reel in sufficient cable; then disconnect the static lines from the anchor cable.

**4-37. Triple Cargo Hook System.**

Three external cargo hooks are provided for attaching external cargo. The hooks can be used with a single load on one hook, two hooks in tandem (forward and aft hooks), or individual loads on three hooks. The tandem hook configuration provides improved load stability at higher airspeeds. With the triple hook system, up to three loads can be deposited at different locations during a single mission. The forward hook is at sta **249**. The center hook is at sta **331**. The aft hook is at sta **409**.

All hooks have normal release modes, emergency release modes, and manual release modes. Normal release mode can be controlled by both pilots or by the hoist operator. Emergency release of all hooks can be performed electrically by either pilot or manually by the crew member.

**CAUTION**

Do not lift or rotate the center cargo hook into the cabin area or allow the mid hook

to lay on the cargo floor or access door panel during inspection or use. The excessive tension placed on the triple emergency release cable housing assembly may partially dislodge the housing and engage or activate the forward and aft hook emergency release mechanism. This may cause an inadvertent release of loaded forward and aft hook assemblies in flight.

**4-38. Center Cargo Hook.** The position of the center cargo hook is such that the load is suspended beneath the CG of the helicopter at sta 331. The hook assembly consists of a hook, hydraulic actuator, and a release mechanism. The hook is suspended by means of a beam which is mounted inside the rescue hatch. This beam rotates within its mounting supports for longitudinal swing. The hook pivots about its attachment bolt for lateral swing. The cargo hook system is normally operated hydraulically by pressure from the utility hydraulic system. In the event of a loss in utility system pressure, the cargo hook can be opened pneumatically or manually. The cargo hook contains a spring-tensioned keeper which prevents accidental loss of cargo through slippage of the sling rings. When not in use, the cargo hook can be removed from the hatch since both the electrical and hydraulic lines are equipped with quick-disconnectors or the cargo hook can be stowed. The cargo hook and beam assembly must be removed for rescue operations through the hatch.

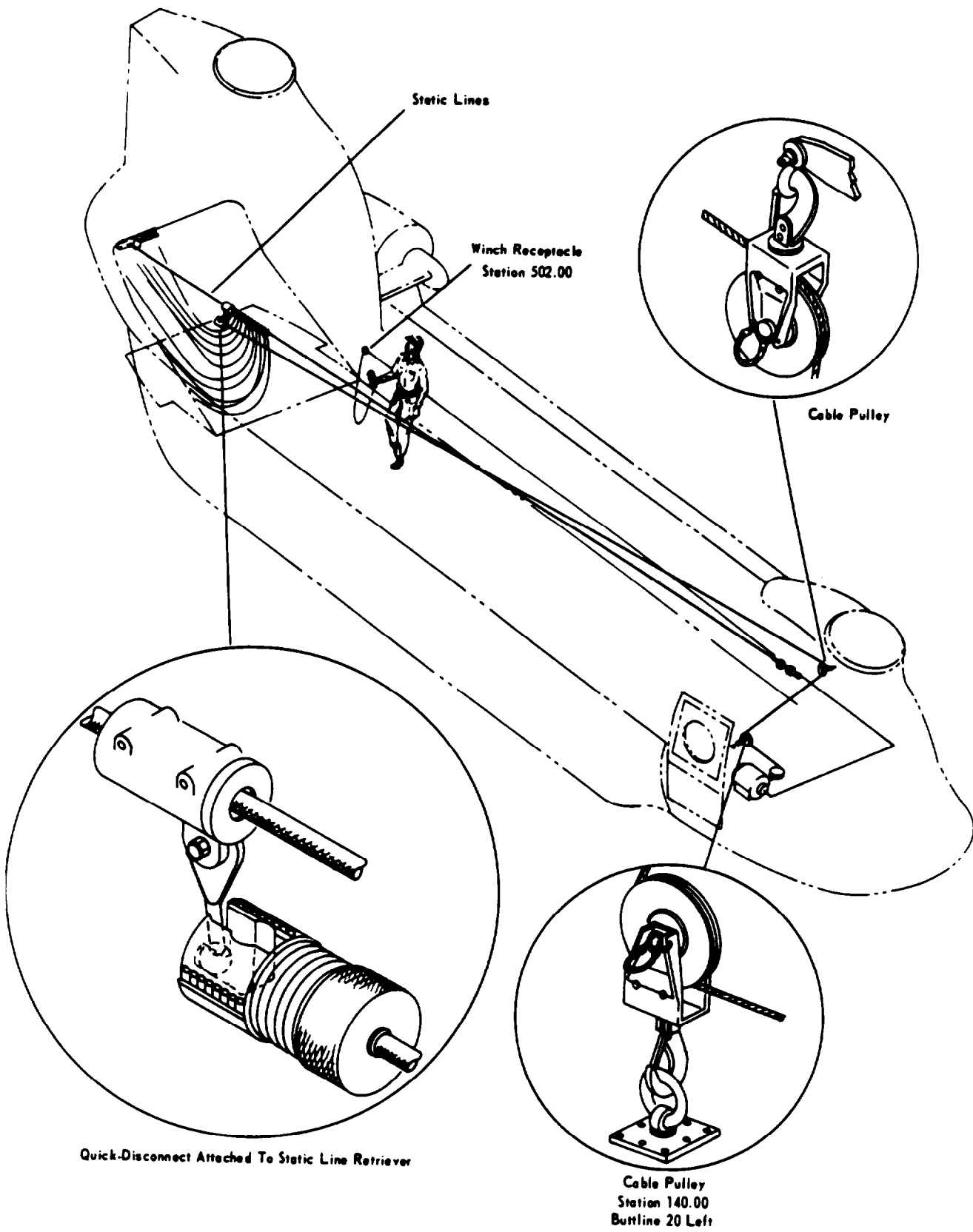
**4-39. Center Cargo Hook Loading Pole.****WARNING**

Make sure the ground cable is connected. With the rotors turning, static potential between the helicopter and a load on the ground can be as high as 40,000 volts.

A cargo hook loading pole (fig. 4-29) is provided for picking up the sling loop of external cargo loads from inside the helicopter. The loop is then placed on the cargo hook by hand. The pole has a hook at one end and a cable at the other end. The cable is attached to the fuselage to prevent accidental loss of the pole when in use and to provide a discharge path for static electricity. When not in use, the pole is stowed on the lower right side of the cabin at about sta 360.

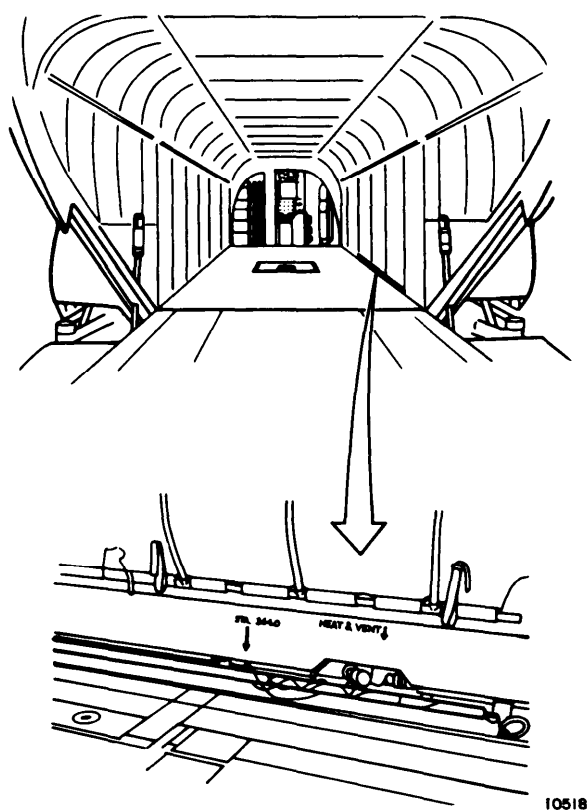
**4-40. Forward and Aft Cargo Hooks.**

The forward and aft cargo hooks (fig. 4-31) are attached to bottom centerline of the helicopter at sta **249** and **409**. Unlike the center hook, these hooks are not accessible to the crew in flight. Both hooks have electrical normal and emergency release mechanisms. The normal mechanisms can be operated by either pilot or by the hoist operator. In an emergency, both hooks can also be released from the cockpit through a dedicated emergency release circuit or manually by the hoist operator. A knurled knob on the side of each hook allows the hook to be opened by a ground crewman. A



14818

Figure 4-28. Static Line Retriever System



**Figure 4-29. Center Cargo Hook Loading Pole (Typical)**

spring-loaded keeper prevents accidental loss of cargo through slippage of sling rings. Each hook has a hook-loaded sensor. The sensor will close and light a hook loaded advisory light when the hook load exceeds approximately 150 pounds. Stops on the hook allow the hook to swing approximately 80° between full forward and full aft and approximately 50° full right to full left.

#### 4-41. Cargo Hook Controls.

The cargo hook control can be operated from the cockpit by a switch on each cyclic stick grip and switches on the overhead panel (fig. 4-20). The hooks can be operated from the cargo compartment by a switch on the winch/hoist control grip (fig. 4-24) and switches on the hoist operators panel (fig. 4-25). Normal power to control the cargo hook system is supplied by the 28-volt DC bus, through the CARGO HOOK NORM RELEASE PWR and CONT circuit breakers on the No. 2 PDP. Power to operate and control the emergency release is provided by the 28-volt DC bus through the CARGO HOOK EMER RELEASE PWR and CONT circuit breakers on the No. 1 PDP.

a. **CARGO HOOK MSTR Switch.** The CARGO HOOK MSTR (master) switch is on the CARGO HOOK panel (fig. 4-20) of the overhead panel. The switch has three positions marked ARM, OFF, and RESET. When the switch is set to ARM, power is applied to the CARGO HOOK RELEASE switches on

the cyclic sticks and also to the CARGO HOOK ARMING switch at the hoist operator's station. OFF position is used to close the mid cargo hook. RESET position is used to turn off the FWD, MID, and/or AFT HOOK OPEN caution capsule(s).

b. **CARGO HOOK SEL Switch.** The CARGO HOOK SEL (select) switch is on the CARGO HOOK panel on the overhead switch panel. It is a five position rotary switch marked HOOK SELECT. The switch positions are FWD, MID, AFT, TANDEM, and ALL. The position of this switch determines which hook or hooks open when the CARGO HOOK RELEASE switch on either cyclic stick or the hoist operator's grip is pressed.

c. **CARGO HOOK ARM Switch.** A CARGO HOOK ARM (arming) switch is on the hoist operator's panel (fig. 4-25) in the cargo compartment. The hoist operator's control panel CARGO HOOK ARM switch has three marked positions: ARM, RMTE (remote), and RESET. When the cockpit CARGO HOOK MASTER switch is at ARM, and the hoist operator's switch is moved to ARM, power is applied to the CARGO HOOK RELEASE switch, on the winch/hoist control grip. When the switch is at RMTE, power is removed from the CARGO HOOK RELEASE switch and the cargo hooks can be operated from the cockpit only. RESET position is used when the pilot requests that the center cargo hook be closed from the hoist operator's station. When the switch is set to RESET, the CARGO HOOK OPEN cautions will go out.

d. **CARGO HOOK RELEASE Switches.** A CARGO HOOK RELEASE switch is on each of the following: the pilot's and copilot's cyclic grip, and the winch/hoist control grip. Any one of these switches can be used to operate the cargo hooks. Each of these switches are the momentary type. When either the pilot's or copilot's CARGO HOOK RELEASE switch is pressed with the CARGO HOOK MASTER switch at ARM, the hook or hooks selected on the HOOK SELECT switch will open. The forward and aft hooks will open, then close. The center hook, if selected, will open and remain open until the cargo hook MASTER switch on the overhead panel is set to OFF or the cargo hook ARM switch on the hoist operators panel is set to RESET.

### **CAUTION**

**The forward and aft hooks may fail to open if the slings are slack when the release solenoids are energized (a load of approximately 20 pounds is required for opening). The hooks can be opened by selecting the desired hook(s) and depressing the release switch as the aircraft is lifted to apply tension to the slings.**

e. **CARGO HOOK EMERG Switch.** The emergency cargo hook release switch is on the CARGO HOOK control panel. It is a guarded switch and it is labeled EMERG REL ALL (emergency release all). The switch

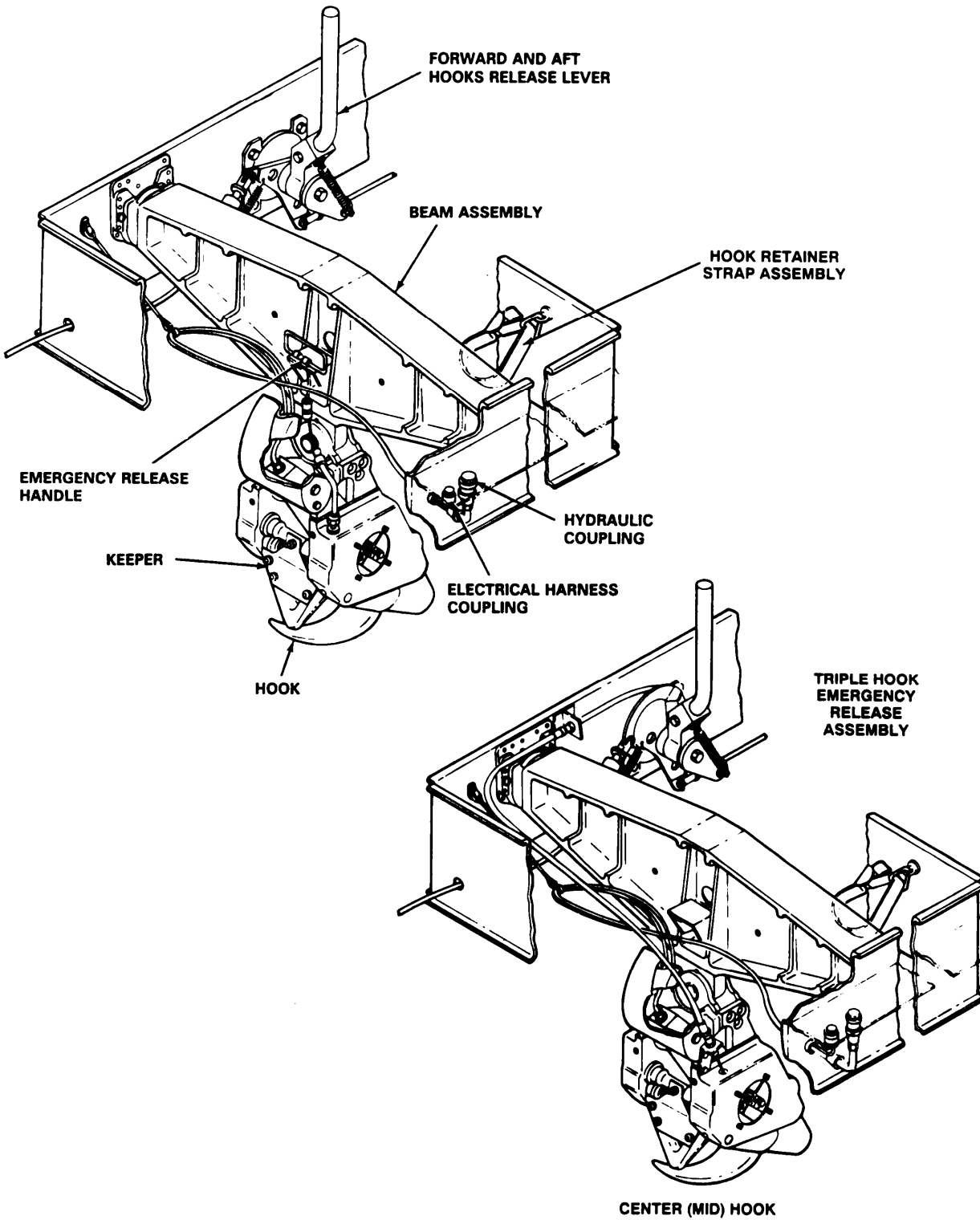


Figure 4-30. Center Cargo Hook and Cargo Hook Release

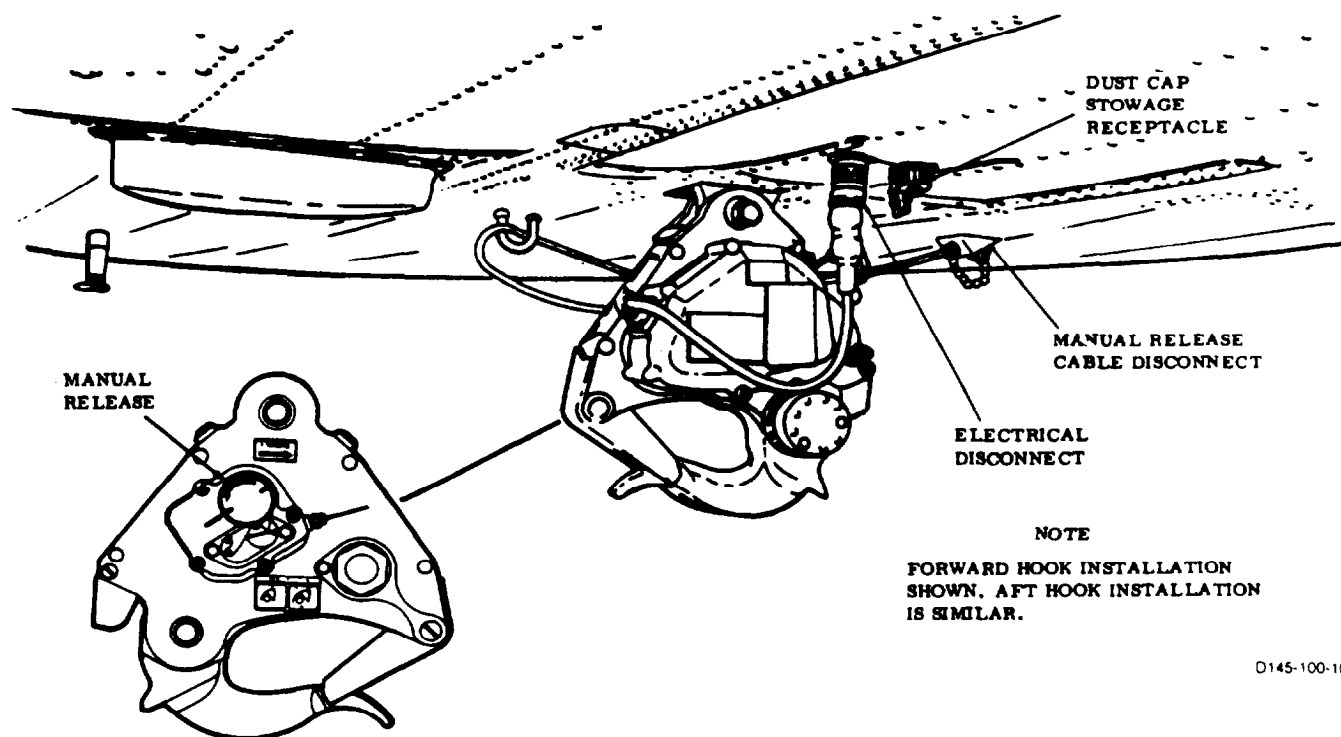


Figure 4-31. Forward and Aft Cargo Hooks

is used to simultaneously open the three hooks, if an emergency situation develops. The three hooks will open regardless of CARGO HOOK MSTR or HOOK SEL switch positions. Setting the switch to REL ALL, energizes an emergency hook release relay. The relay then energizes release solenoids in the forward and aft hooks and a solenoid valve in the center hook. The solenoid valve in the center hook releases the aircharge stored in the lower half of the hydraulic actuator, transferring the charge to the upper (release) half of the actuator to open the hook. After this method of opening the hook, the hook actuator must be recharged to 2,000 to 2,100 psi. The emergency hook release relay will automatically deenergize after a 10 second time delay. This prevents damage to the hook release solenoids.

#### CAUTION

Before external load operations, crewmembers shall familiarize themselves with the manual emergency cargo release mechanism installed on the helicopter.

**4-42. Manual Emergency Release Systems.** The triple cargo hook system has two manual emergency release systems configurations: one system has a center hook “D” ring to release the center hook, and a release lever for the forward and aft hooks. The other system incorporates both mechanisms requiring activation of only one lever to open all three hooks (fig. 4-30).

#### WARNING

When the center cargo hook is opened with the external load off the ground, the cargo hook will whip back and forth.

#### CAUTION

When the center cargo hook is opened using the manual emergency release handle, the hook must be closed manually. No attempt should be made to close the hook using the normal hydraulic or pneumatic method, since damage to the cargo hook can result.

#### 4-43. Manual Emergency Release Systems.

a. *Manual cargo hook release mechanisms requiring independent operation, (forward and aft and “D” ring).* The center hook is equipped with a manually operated cargo hook release handle (“D” ring), secured to the cargo hook assembly. It is used to release the hook should failure in the utility hydraulic or electrical system occur. A spring-tensioned cargo hook release lever controls a camshaft which keeps the hook locked in the closed position. A metal cable connects the lever arm to the release handle which is held in place on the support beam by metal clips. When the “D” handle is pulled upward, the lever moves the camshaft enough to allow the cargo hook to swing free, releasing the load. The

forward and aft hook release lever is located on the right side of the rescue hatch. The manual release lever for the forward and aft hooks is in the rescue hatch. The handle is connected by cables to the manual release mechanism in the forward and aft hooks. The lever has three positions: vertical, forward, and aft. In the stowed position, the lever is pointing forward. The vertical position is the normal position when external cargo is-carried on the forward or aft hook. The aft spring-loaded-to-ready position releases the forward and aft hooks simultaneously, loaded or not.

b. *Single handle cargo hook release system.* This release system incorporates the release mechanisms for all three cargo hooks. The "D" ring on the center hook has been replaced with a cable routed to the release lever on the right side of the rescue hatch. The lever has the same functions and positions as the forward and aft release lever. Activation of the lever by pulling aft will open all three cargo hooks.

**4-44. Cargo Hook Cautions.** The cargo hook caution capsules are on the master caution panel. They are labeled FWD HOOK OPEN, MID HOOK OPEN, and AFT HOOK OPEN. A lit caution capsule indicates that the corresponding hook has opened. The cautions can be extinguished by setting the CARGO HOOK MSTR switch to RESET or by setting the CARGO HOOK switch on the hoist operators panel to RESET.

**4-45. Hook Loaded Advisory Lights.** Two advisory lights marked HOOK LOADED are on the CARGO HOOK control panel (fig. 4-20). The lights are marked HOOK LOADED. When on, the light indicates that the corresponding (forward or aft) hook has a load of above approximately 150 pounds on it. The lights are turned on by sensors in the forward and aft hooks.

**WARNING**

If the DUAL HOOK FAULT light indicates a malfunction of the forward or aft hook, releasing the load using other than the manual release handle is prohibited.

**4-46. Dual Hook Fault Caution.** A caution capsule labeled DUAL HOOK FAULT is on the master caution panel. This light provides continuous monitoring of the electrical continuity of the release solenoids in the forward and aft hook. When on, it indicates a loss of electrical release capability of the forward and/or aft hook in both normal and emergency modes. When the capsule is on, loads on the forward or aft hooks can only be released by the manual release system.

**4-47. Cargo Hooks Operational Check.**

**WARNING**

When stowing or positioning the cargo hook, do not grasp the hook assembly by the synchronizing assembly shaft. Serious injury can result if the hook is operated while the hand is in this position. The nylon web strap is to be used when positioning or stowing the hook.

Before external load operations, perform the following check of the cargo hooks.

1. CARGO HOOK MSTR switch – ARM.
2. CARGO HOOK SEL switch – FWD.
3. Press the CARGO HOOK RELEASE switch on the pilot's cyclic stick – Check that the FWD HOOK OPEN caution capsule comes on and the hook opens.

**NOTE**

The forward and aft hooks will not open unless a force is applied. As long as one of the CARGO HOOK RELEASE switches are pressed, the forward and aft hooks will make a chattering sound. This sound indicates the hook solenoids are operating normally.

4. CARGO HOOK SEL switch – MID.
5. Press the CARGO HOOK RELEASE switch on the copilot's cyclic stick. Check that the MID HOOK OPEN caution capsule comes on and the hook opens.
6. CARGO HOOK SEL switch - Am.
- F 7. CARGO HOOK switch on HOIST OPERATORS PANEL - ARM.
- F 8. Press the CARGO HOOK RELEASE switch on the WINCH/HOIST CONTROL GRIP . Check that the AFT HOOK OPEN caution capsule comes on and the hook solenoid activates. RESET and release to OFF.
9. CARGO HOOK MSTR switch - RESET and release to OFF. Check all HOOK OPEN caution lights go out and the hooks close. Then set ARM.
10. CARGO HOOK SEL switch – TANDEM.
11. Press the CARGO HOOK RELEASE switch on the pilot's cyclic stick. Check that the FWD and AFT HOOK OPEN caution capsules come on and the forward and aft hook solenoids activate.
12. CARGO HOOK MSTR switch – RESET and release to OFF. Check both HOOK OPEN caution capsules go out and the hooks close. Then set to ARM.
13. CARGO HOOK SEL switch – ALL.
14. Press the CARGO HOOK RELEASE switch on the copilot's cyclic stick. Check that all HOOK OPEN caution capsules come on and the hooks open or the solenoids activate.
15. CARGO HOOK MSTR switch – RESET and release to OFF. Check all HOOK OPEN cautions go out and the hooks close.
16. To confirm safety of the cargo hook system, the pilot, copilot, and flight engineer each press a CARGO HOOK RELEASE switch to attempt to open cargo hooks with the CARGO HOOK MSTR switch at OFF.



**4-48. Normal Operation of Cargo Hooks.**

Normal operation of the cargo hooks from the cockpit or from the cargo compartment is as follows:

1. CARGO HOOK MSTR switch – ARM. (If used from the cockpit or the cargo compartment.)
2. HOIST OPERATORS PANEL CARGO HOOK switch – ARM. (If used from the cargo compartment.)
3. HOOK SEL switch – Rotate to hook or hooks to be released.
4. CARGO HOOK RELEASE switch – Press. (From either the cockpit or the cargo compartment.)
5. Master caution panel – Check HOOK OPEN cautions come on.
6. Loads – Check released. If the forward or aft hooks did not open because of sling slack, press the release switch and lift the helicopters to apply a strain to the sling and pull the hooks open.

**4-49. Emergency Operation of Cargo Hooks.**

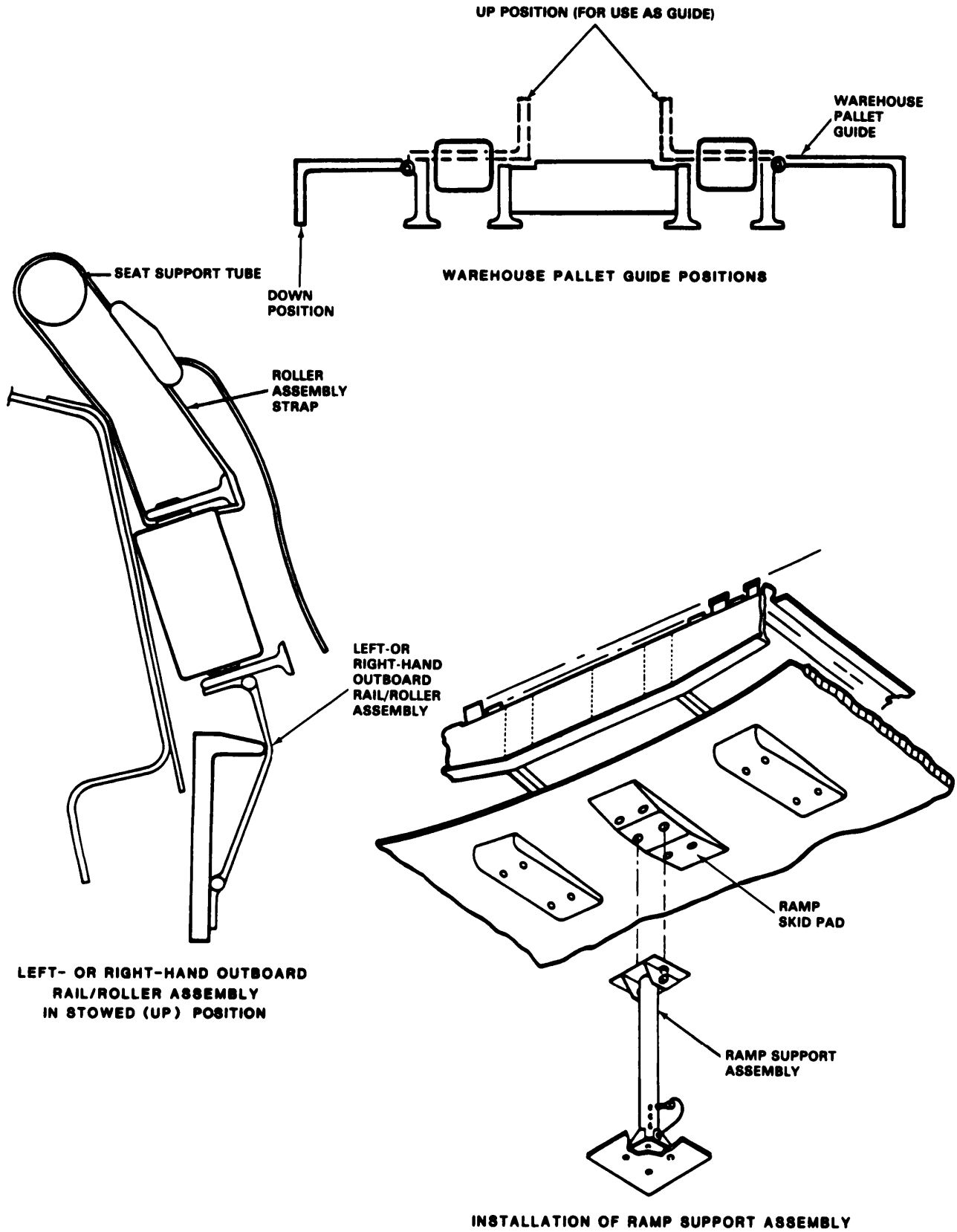
Refer to Chapter 9 for emergency operation of cargo hooks.

**4-50. Helicopter Internal Cargo Handling System (HICHS).**

An internal cargo handling system is provided for quick loading securing and unloading of palletized cargo (fig. 4-32 and 4-34). The system consists of a set of rail assemblies and guide roller assemblies that are secured to the helicopter floor. For descriptive information, service/maintenance instructions, operation, installation and removal instructions, refer to TM 55-1680-358-12 & P.

The system has three main sections: a cabin section, a ramp section, and a ramp extension section (fig. 4-34). The cabin section has outboard rail/ rollers along both sides of the cabin, and inboard guide rollers running along the center of the cabin. There are six outboard rail / roller assemblies, three on each side of the cabin. Each of the six rail / roller assemblies has its own dedicated

*Figure 4-32. HICHS with 463L Palletized*



13935

Figure 4-33. Fixture Configuration

location in the helicopter. The left and right side rail/roller assemblies are symmetrically opposite. There are four inboard guide roller assemblies mounted in the center of the cabin. All of the outboard and inboard roller assemblies are installed by being bolted to the existing tiedown fitting locations in the cabin floor.

The system is equipped with a set of locking devices and tiedown fittings for securing loaded cargo.

#### NOTE

All cargo must be properly restrained to ensure safe operation of the helicopter and the safety of personnel. Loads must be restrained in accordance with procedures and guidelines in Chapter 6 and FM 55-450-2, Helicopter Internal Loads.

The ramp section has two inboard roller assemblies along the center of the ramp and two outboard guide/roller assemblies along the sides of the ramp. A ramp support assembly is used to support the ramp when loading or unloading the helicopter with the ramp in the horizontal position.

The ramp extension section has two ramp extension roller assemblies and two ramp extension support assemblies to support the ramp extensions when loading and unloading with the ramp in the horizontal position.

**4-51. HICHS Cargo Types.** The HICHS allows relatively quick and easy loading of palletized cargo. The following pallet types may be used:

- a. Three 463L pallets, 88 x 108 inches.
- b. Six HCU-12/E or HCU/C pallets, 54 x 88 inches.
- c. Eight to ten warehouse wooden pallets, 40 x 48 inches.

The HICHS has provisions for locking and securing 463L pallets. This type of pallet does not need to be tied down but the cargo must be secured to the pallet. Combinations of different pallet types may be used. Miscellaneous cargo and equipment may be carried providing that they do not exceed weight or floor loading restrictions, and can be properly tied down.

**4-52. System Configurations.** The HICHS can be placed in any of four configurations. These are loading, restraint, flight, and unloading. Refer to Chapter 6 for configurations applicable to 463L pallets, warehouse pallets, and wheeled vehicles.

To accomplish the configurations described above and in the referenced tables, several components must be set in a predetermined position. These components are listed below in conjunction with the illustration that defines the component location and or position.

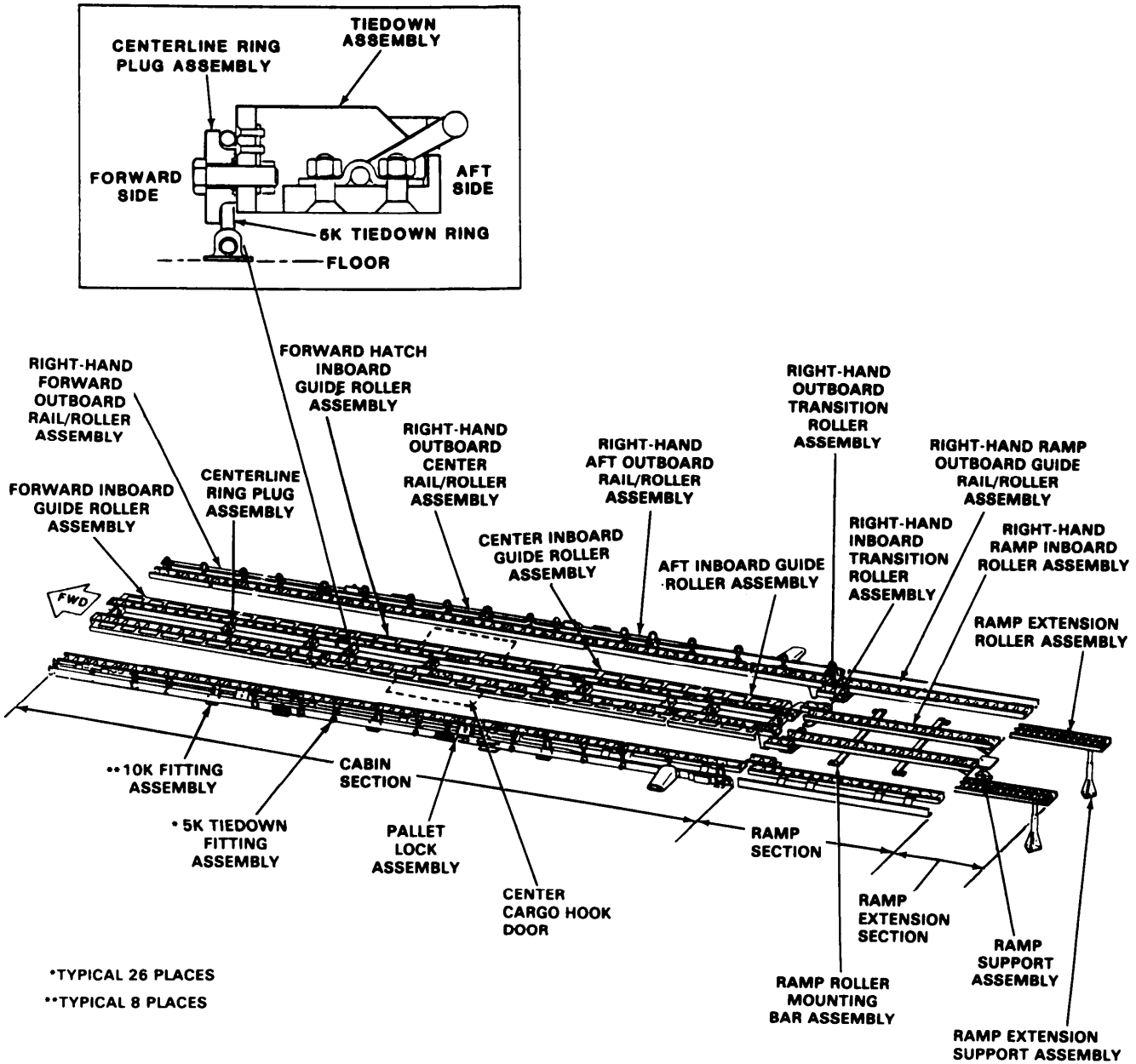
- a. Outboard rollers – fig. 4-33.
- b. Warehouse pallet guides – fig. 4-33.
- c. Ramp support assembly – fig. 4-33.
- d. Pallet lock assembly – fig. 4-34.
- e. Retractable flange assembly – fig. 4-32.
- f. 10K fitting assemblies - fig. 4-35.
- g. 5K fitting Assemblies – fig. 4-35.

**4-53. Hatch Access.** Remove, if necessary, any cargo forward of sta 377.250 to at least sta 157.750.

Remove three centerline ring plug assemblies to free the forward hatch inboard guide roller assembly (fig. 4-34). Stow the removed parts ahead of sta 272.250. The hatch is now accessible and the removed parts can be re-installed by reversing the preceding steps.

**4-54. System Stowage.** Flip-up the outboard rail/roller assemblies and secure the seat support tube as shown in fig. 4-33. Secure loading pole to clips located at the top of the buffer board between sta 300 and 400 on right side of helicopter with quick release pin. Inboard guide roller assemblies can be stowed on the floor beneath the troop seats. Secure ramp extension rollers to the underside of the ramp extensions with quick release pins. Stow ramp extension supports on the left side of the helicopter in brackets mounted between sta 520 and 534. Stow ramp support at sta 550 left side.

**4-55. Load Configuration and Sequence.** Chapter 6 contains the detailed descriptions and procedures for load configuration and sequence.



13936

Figure 4-34. Internal Cargo Handling System

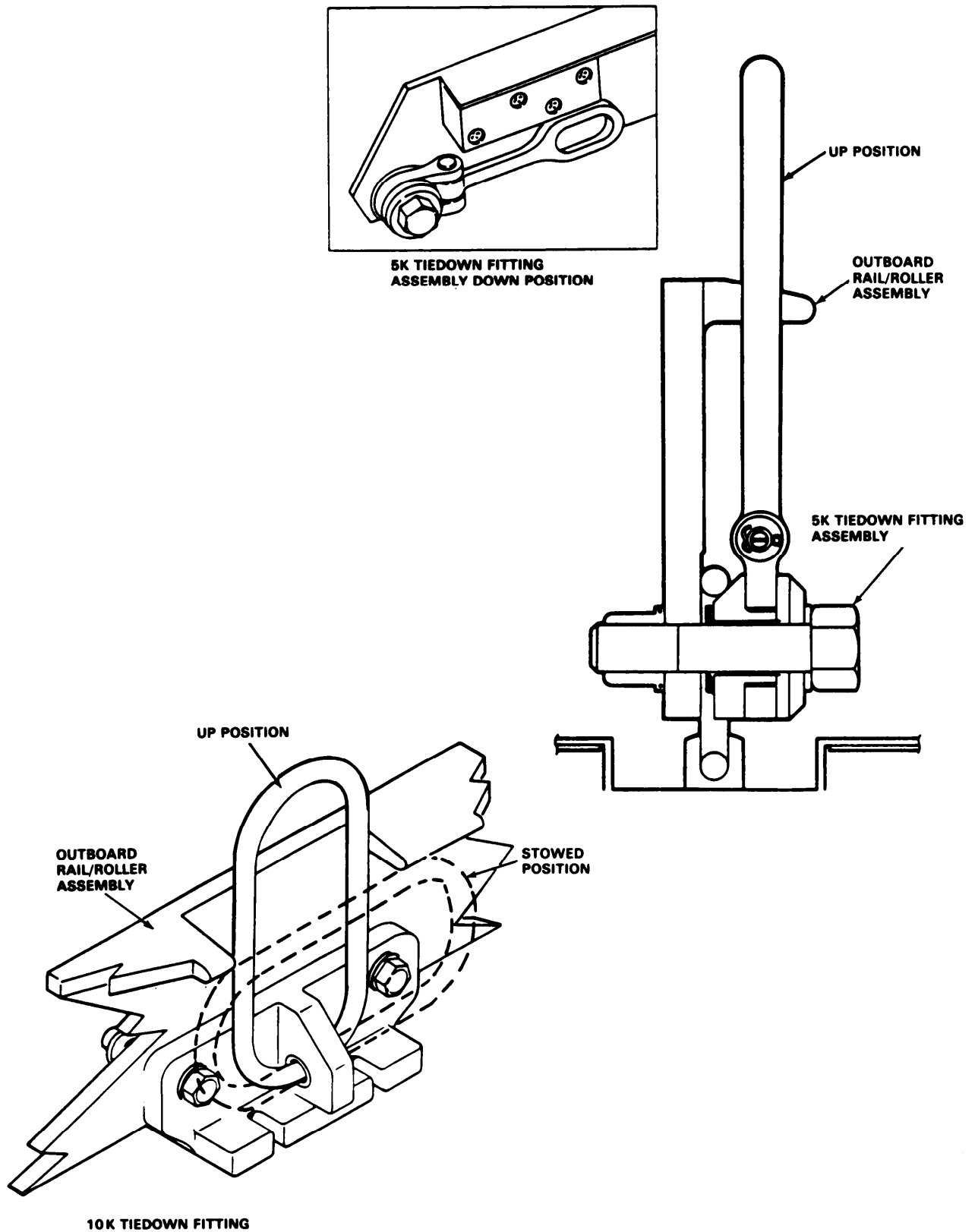


Figure 4-35. Tiedown Fittings HICHS

## SECTION IV EXTENDED RANGE FUEL SYSTEM (ERFS) AND ERFS II

### WARNING

The ERFS is a non-crashworthy auxiliary fuel system. The use of non-crashworthy internal extended range fuel system may compromise the helicopters crashworthiness and may increase the risk of burns in a potentially survivable accident.

#### 4-56. Extended Range Fuel System.

The ERFS provides mission flexibility as an extended range mission kit and a forward area refueling source. The ERFS is mounted on the left side of the cabin between sta 109 and 450, depending on the helicopter CG limits. The ERFS is a modular, interconnected system composed of up to four 600 gal **non-crashworthy** metal tanks, four electrically operated fuel pumps, and a vent system with associated wiring and plumbing. The tanks are secured using 5K and 10K pound cargo straps. The fuel management control panel (FMCP) is housed in an aluminum box and is mounted on the forward most tank. Refer to TM 55-1560-307-13&P for installation, operation, and maintenance procedures.

### WARNING

Chains will not be used to tie down the ERFS.

### CAUTION

FMCP will not be operated without fuel in the tank(s), or with tank cam lever in the CLOSED position.

### CAUTION

A fuel sample is required before the first flight of the day.

### CAUTION

Hot refueling is not recommended.

### NOTE

For clarity, the tanks are numbered front to rear 1,2,3,4. In order to maintain helicopter CG, suggested tank burn is 4, 1, 3, 2.

#### 4-56.1. Extended Range Fuel System II.

The Extended Range Fuel System II (ERFS II) is an internal tank fuel system that provides the CH-47D with the ability to fly for an extended period of time without having to land for refueling. The ERFS II may be installed in one, two or three tank applications in addition to the Forward area Refuel Equipment (FARE) kit installation. Through the use of a FARE kit, the CH-47D can also be used to ferry fuel to forward areas to support refueling operations of other aircraft and equipment. The system

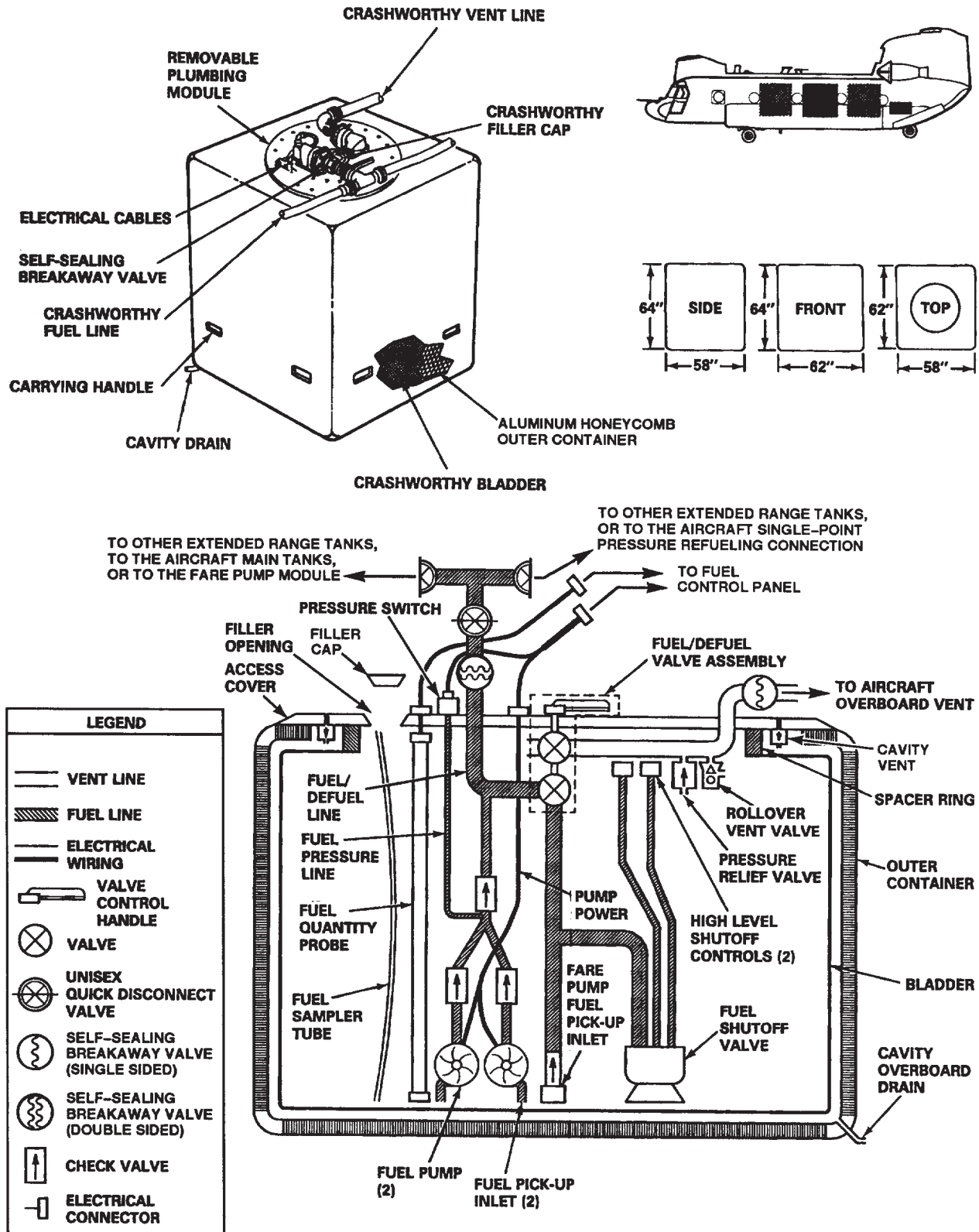
consists of five functional components: the fuel tank assembly with fuel and vent hoses, restraint system, ERFS II Fuel Control Panel, and FARE kit assembly. References and illustrations provided describe the three tank and FARE kit installation. Power is supplied to the ERFS II from the No. 1 DC BUS and No. 1 AC BUS through LH Utility Receptacles and wiring harness to the ERFS II Fuel Control Panel. Refer to TM 55-1520-240-23 and tM 1-1560-312-10 for installation and maintenance procedures.

#### 4-57. ERFS Capabilities.

- a. The ERFS provides up to **2320** gallons, (**580** gallons maximum per tank) of usable fuel for extended range missions.
- b. The ERFS can be installed, operated, removed, transported, handled, and stored in climatic conditions of **-32°C to +52°C**.
- c. The ERFS can be installed and used in a one tank or multiple tank configuration as the mission requires.
- d. Fuel quantity can be accurately monitored in flight within four percent of the actual quantity using the liquid level indicators.
- e. The ERFS can be refueled using the splash fill or pressure fill techniques.
- f. The system can also be defueled using standard equipment.
- g. The ERFS has redundant fuel feed capability in all pump/tank combinations.
- h. Fuel transfer pump system can operate with APU, engine, or external power applied.
- i. The ERFS can be used as a forward area refueling equipment (FARE) system, providing **2320** gallons of fuel for refueling other helicopters.

#### 4-57.1. Fuel Tank Assembly.

The ERFS II fuel tank assembly consists of an outer aluminum honeycomb and fiberglass shell container, ballistically self-sealing bladder, plumping module, fuel hose, vent hose assembly, and ground cable. Each tank measures **58 inch L x 62 inch W x 64 inch H** with the capacity of **800 to 820** gallons of usable fuel and empty weight of approximately **607** pounds (fig. 4-36). ERFS II tanks are designed to be loaded and unloaded by four persons (with restraint system in place) in no more than 10 minutes and require no tools. The tanks should not be unloaded with any quantity of remaining fuel. When the tanks are installed there is an aisle up the right side of the aircraft which is approximately 25 inches wide. the plumbing module consists of an aluminum access cover secured to an energy-absorbing aluminum tube or column. The in-tank plumbing components are attached to a column in the center of the



A72474

Figure 4-36. ERFS II Fuel Tank

tank permitting easy removal and maintenance on components. A **75 psi** fuel cap, dual transfer pumps, fuel quantity probe, fuel sampling tube, and fuel pressure switch are the internal parts of each of the tanks. Refueling the ERFS II tanks is performed by either the helicopter Single Point Refueling System or gravity.

a. *Fuel Hoses.* An interconnecting fuel hose manifold connects the ERFS II tanks together. A two inch hose connected at the forward end of the ERFS II fuel manifold is connected to the helicopter Single Point Refueling System in the vicinity of STA 255 on the left side of the cargo compartment. Fuel transfer hoses connected at the aft end of the manifold carry fuel to the aircraft fuel system quick disconnects at STA 380 on both left and right sides of the cargo compartment.

**CAUTION**

**Up to 4 OZ. of fuel can be trapped between the closed “Dry Break” valves in the Unisex couplings. Care should be taken to minimize spillage of this trapped fuel when separating the couplings.**

b. *Vent Hose Assembly.* Aircraft overboard vents and connections are installed on the left side of the cabin area through the fuselage at STA 254.0, 330.0, and 410.0. Overboard fuel vent caps must be removed anytime internal fuel tanks are installed. Vent hoses are connected to the tank vent line at the self-sealing breakaway valve on top of the tank assembly and one of the three aircraft overboard vent connections.

**CAUTION**

**Trying to pressure refuel the tanks without connecting the vent line could overpressurize the tanks.**

The vent hose assembly allows the venting to atmosphere of fuel vapor, thus providing vent air to relieve internal tank pressures. Fuel hoses and manifold are self-sealing incorporating Unisex couplings. Each Unisex coupling, ballcock valve, permits hose removal without fuel spillage. The manifold also provides connection to the FARE pump module. The fuel/defuel valve is a manually operated vented valve that simultaneously opens a high flow rate fuel path in the fuel/defuel line, and a high flow rate vent path out of the tank. The valve must be open for pressure refueling of the tanks, FARE operations, or suction defueling. An automatic fuel shutoff valve, with dual high level shutoff controls is located inside the tank. Inside each of the tanks is an open vent valve to allow fuel to vent overboard in the event of high level shutoff valve failure.

**4-58. Restraint System.**

Each tank restraint system consists of an aluminum frame and straps of polyester webbing with connecting hardware and ratcheting buckles. This system provides longitudinal, vertical, and lateral restraint. The forward, vertical, and lateral restraint ratings are **8g's** and the aft rating is greater than **3g's**. Each of the buckles are connected to twelve 5,000 pound tiedown rings on the helicopter cargo floor.

**4-59. ERFS II Fuel Control Panel.**

All transfer of ERFS II fuel into the helicopter main fuel tanks is controlled by the ERFS II Fuel Control Panel (fig. 4-37). The control panel is located and mounted on the forward most ERFS II tank facing forward. It has individual switches that control the operation of the transfer pumps and circuit breakers to protect each of the pumps in the tank. Illumination is controlled by a dimmer rheostat on the fuel control panel and is night vision goggles (NVG) compatible. Electrical cables run from cargo compartment AC and DC utility outlets at STA 358 and 320 to the ERFS II fuel control panel, and from the panel to connectors on each tank. A fuel quantity gauge is installed on the panel to provide readings in pounds of fuel for the individual tanks and their combined total fuel remaining.

**4-60. Fuel Transfer to Helicopter Main Tanks.**

a. Manual FUEL/DEFUEL valve in all installed ERFS II tanks – CLOSED.

**NOTE**

An OPEN manual FUEL/DEFUEL valve on the transferring ERFS II tank will significantly reduce the transfer rate because of fuel circulation inside the tank. An OPEN valve on a non-transferring tank will result in fuel transfer into that tank if it is not full.

b. Unisex valves in ERFS II fuel transfer hose assembly – OPEN.

c. Select the ERFS II tank from which fuel is to be transferred.

d. PUMP switch for the selected tank – OVERRIDE. Hold in this position until PRESS LOW light goes out (normally less than five seconds). When released, the spring-loaded switch will return to the ON position and fuel transfer will continue.

e. Monitor the helicopter fuel indicators to verify fuel transfer.

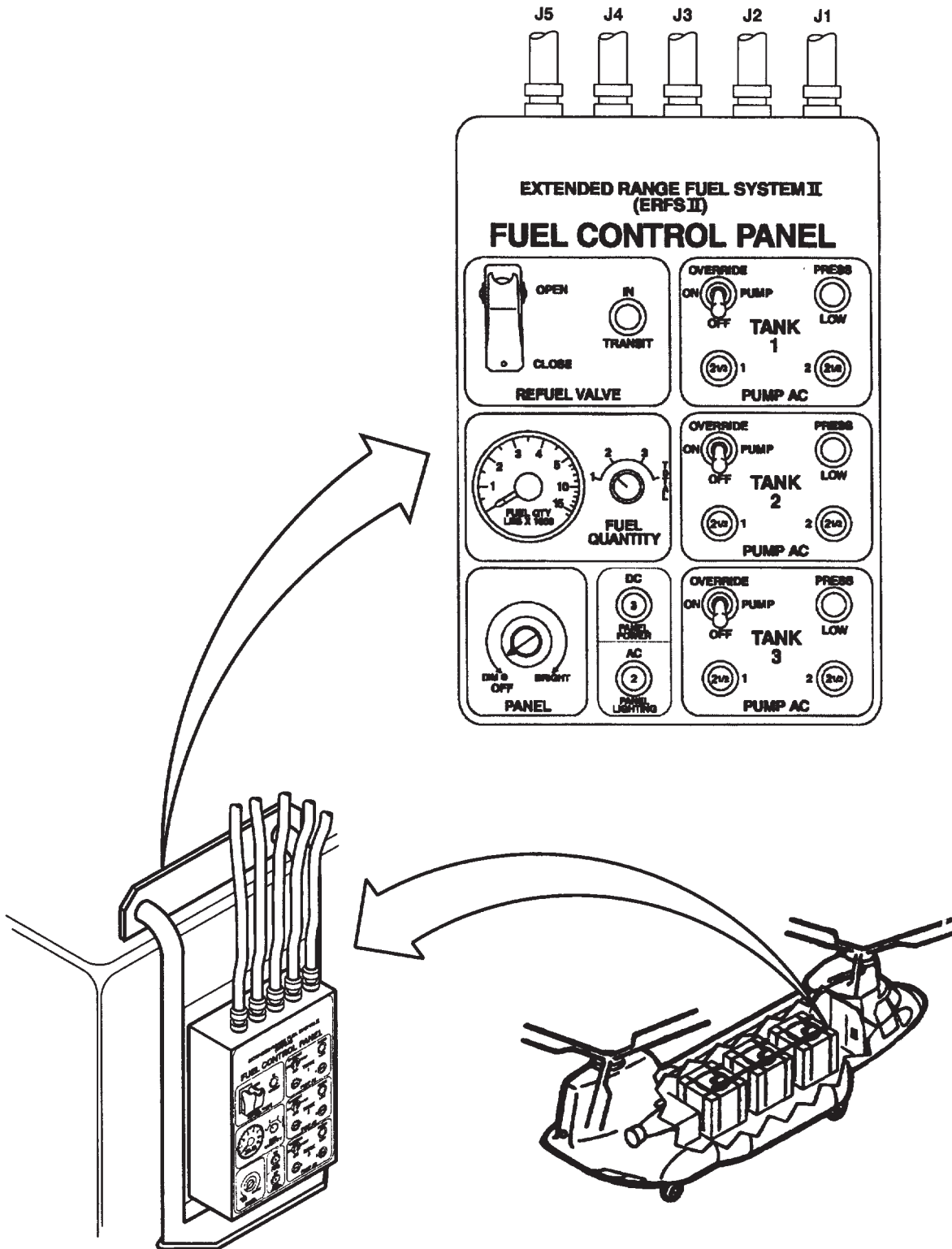
f. PUMP switch for selected tank – OFF when directed by the pilot or when the PRESS LOW light illuminates.

g. FUEL QUANTITY switch – Set to 1, 2, or 3 for selected tank to confirm desired amount of fuel transferred.

**4-61. Forward Area Refuel (FARE) Kit Assembly.**

The FARE kit contains a pump module with a self-priming pump rated at **120 GPM** and Flowmeter. The pump can be used to either fuel or defuel the ERFS II tanks. The pump module easily mounts on any one of the tanks when used. A manually operated valve reverses the fuel flow and permits defueling of the hoses after FARE operation. Two in-line, multiple cartridge filters capable of filtering out 5 micron absolute particulates are included as part of the FARE kit. The 45 inch x 44 inch x 35 inch container for FARE component storage is secured to the cargo floor (fig. 4-38).





A72256

Figure 4-37. ERFS II Fuel Control Panel

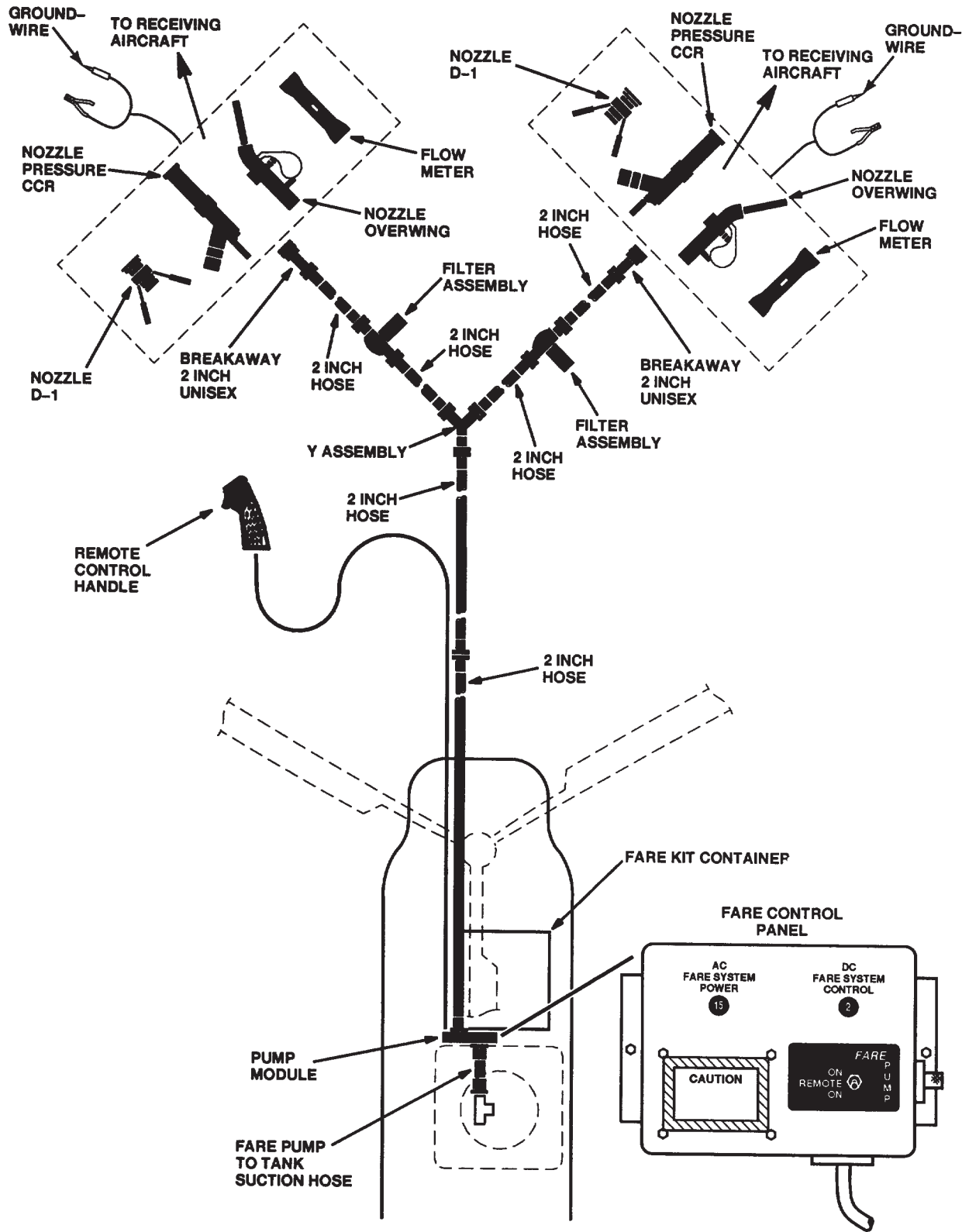


Figure 4-38. FARE Fuel System Schematic

## 4-62. FARE Transfer.

**CAUTION**

Some fuel will remain trapped in the FARE pump module, suction hose, filters, and collapsible hoses after suctioning and rolling of the FARE hoses has been completed. To avoid spilling trapped fuel, the valves in the Unisex couplings must remain closed and the couplings capped after the FARE system is disassembled. All trapped fuel should be drained into an appropriate container when the operational situation permits.

**WARNING**

The manually operated FUEL/DEFUEL valve must be placed in the CLOSED position following FARE operation. Failure to do so could permit significant fuel leakage in the event of a crash and the vent self-sealing breakaway valve fails to actuate.

- a. Single-Point Pressure Refueling Hose Assembly – Unisex valve at ERFS II tank – check CLOSE.
  - b. Valve in the base of the Unisex “T” coupling on tanks that are NOT the fuel source – CLOSE.
  - c. Valve in the base of the Unisex “T” coupling on tank that is the fuel source – OPEN.
  - d. Manual FUEL/DEFUEL Valve on the tank that is the fuel source – OPEN.
  - e. FARE Valve Control Handle – OFF-LOAD.
  - f. Flowmeter DISPLAY button – Press until TOTAL 2 is displayed. Press and hold three seconds to zero batch total.
  - g. FRE PUMP switch – REMOTE.
- To begin FARE transfer.
- h. Remote Control Handle trigger switch – Squeeze.
- When FARE transfer is complete:
- i. FARE Valve Control Handle – SUCTION.
  - j. Valves in the Unisex couplings adjoining the nozzle(s), and filter(s) – CLOSE. Remove nozzles and filters from dispensing hoses, replace dust caps, and stow in FARE container. Reconnect hoses. Valves in the Unisex couplings, except at nozzle end – OPEN. Valve in Unisex coupling at far end of hose assembly – CLOSE.
  - k. Remote Control Handle trigger switch – Squeeze to suction fuel from hose assemblies and return it to tank. While the FARE pump is running, slightly open the Unisex valves at the nozzle ends of the collapsible hoses to permit the pump to evacuate most of the fuel prior to rolling the hose.
  - l. Collapsible Fuel Hose Assemblies – Lift and tightly roll from the nozzle end toward the pump module while the pump is suctioning fuel from the hose. Close the valves in the Unisex couplings as they are reached in the disassembly process. Disconnect the hoses, replace dust caps, and stow in the FARE container. Repeat this process until all collapsible fuel hose assemblies are recovered.
  - m. Remote Control Handle trigger switch – Release.
  - n. FARE PUMP switch – OFF.
  - o. Manual FUEL/DEFUEL valve(s) – CLOSED.
  - p. Valve in the base of the Unisex “T” coupling on all tanks – check OPEN.

## CHAPTER 5

### OPERATING LIMITS AND RESTRICTIONS

#### SECTION I GENERAL

##### **5-1. Purpose.**

This chapter identifies or refers to all important operating limits and restrictions that shall be observed during ground and flight operations.

##### **5-2. General.**

The operating limitations set forth in this chapter are the direct result of design analysis, test; and operating experience. Compliance with these limits will allow the pilot to safely perform the assigned missions and to

derive maximum utility from the aircraft. Limits concerning maneuvers, weight, and center of gravity limitations are also covered in this chapter.

##### **5-3. Minimum Crew Requirement.**

The minimum crew required to fly this helicopter is two pilots, and flight engineer. Additional crewmembers, as required, will be added at the discretion of the commander, in accordance with pertinent Department of the Army Regulations.

## SECTION II SYSTEM LIMITS

### 5-4. Instrument Markings.

**5-5. Instrument Marking Color Codes.** Operating limitations and ranges are identified by the colored markings on the dials of the engine, flight and utility system instruments. The RED markings on the dials of these instruments indicate the limit above or below which continued operation is likely to cause damage or shortened life. The GREEN markings on instruments indicate safe or normal range of operation. The YELLOW markings on instruments indicate the time limited range or when special attention should be given to the operation covered by the instrument. Operation is permissible in the yellow range, but should be avoided. BLUE is a maximum indication associated with sustained operation of the related aircraft system for a prescribed period of time. Limitations (fig. 5-1) which are marked on the various instruments are not necessarily repeated in the subsequent text. When further explanation of certain markings is required, refer to the specific area of discussion.

**5-6. Instrument Glass Alignment.** All instruments with range markings on the glass have short white alignment marks extending from the dial glass onto the rim of the indicator. These slippage marks appear as a single line when limitation markings on the glass properly align with the proper increments on the dial face. However, the slippage marks appear as separate radial lines when a dial glass has rotated.

### 5-7. Rotor Limitations.

Refer to figure 5-1 for limitations. Should **108** percent power off be inadvertently exceeded, no entry need be

made in DA Form 2408-13 unless the rotor system accelerates to **111** percent or above. Even though no action is required when RRPM exceeds **108** percent power off but remains less than **111** percent, willful operation should not be conducted in this range. **712** Operation between **96** and **92** percent (MIN BEEP) is permitted when water taxiing.

**5-8. Inoperative Cruise Guide Indicator.** Flight at or below **98** percent RRPM with an inoperative cruise guide indicator is prohibited.

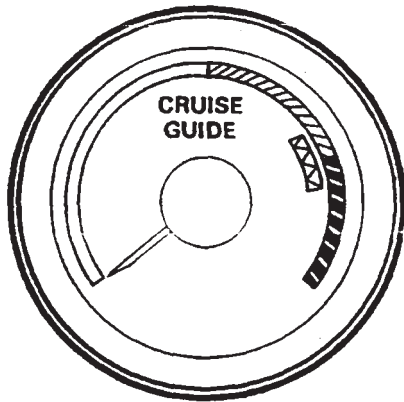
### 5-9. Starting and Shutdown Limits.

The APU shall not be started with a tailwind in excess of 25 knots. Main engines shall not be started with a tailwind in excess of 10 knots. The rotor blade start-up and shutdown limits of Figure 5-7.1 shall be observed. If it becomes necessary to shut down in conditions outside the limits show in Figure 5-7.1, the following precautions are recommended:

a. Aircraft should be landed in an area which is clear, as level as possible, and at least 300 feet away from any vertical obstructions, abrupt changes in ground terrain, trees, bushes, fences etc.

b. Aircraft should be oriented such that the wind would be coming in at the left side. If the pilot is unsure of the wind direction after landing, a crew member should be dispatched beyond the rotorwash to make a true wind direction determination before the engines are secured.

**ENGINE LIMITATIONS  
BASED ON USE OF JP-4 FUEL**



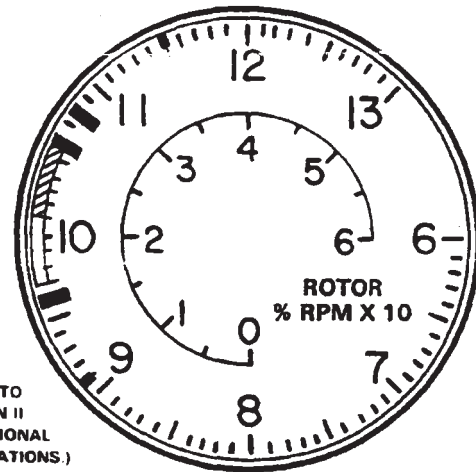
**CRUISE GUIDE  
INDICATOR**

(REFER TO SECTION V FOR  
ADDITIONAL INFORMATION)

- NORMAL OPERATION
- ▨ TRANSIENT
- ▩ AVOID
- ▧ TEST

**RANGE MARK  
LEGEND**

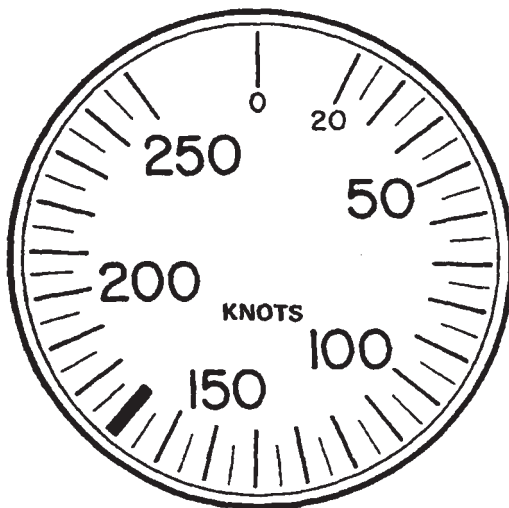
- GREEN
- ▨ YELLOW
- ▩ RED
- ▧ Y & R
- ▧ WHITE (TEST)



(REFER TO  
SECTION II  
FOR ADDITIONAL  
ROTOR LIMITATIONS.)

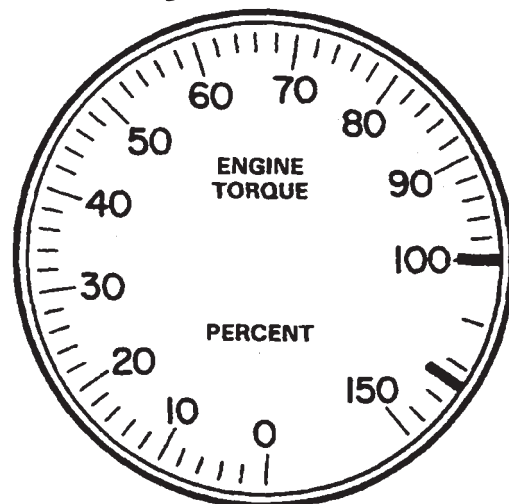
**ROTOR TACHOMETER**

- ▩ 91 PERCENT MINIMUM TRANSIENT
- ▩ 96 PERCENT DISREGARD (NOT APPLICABLE)
- 97 TO 101 PERCENT NORMAL OPERATION
- ▨ 102 TO 105 PERCENT TRANSIENT
- ▩ 106 PERCENT MAXIMUM TRANSIENT POWER ON
- ▩ 108 PERCENT MAXIMUM DURING AUTOROTATION
- ▩ 111 PERCENT MAXIMUM TRANSIENT



**AIRSPEED**

- ▩ 170 KNOTS MAXIMUM
- (REFER TO SECTION V FOR  
ADDITIONAL AIRSPEED  
LIMITATIONS.)

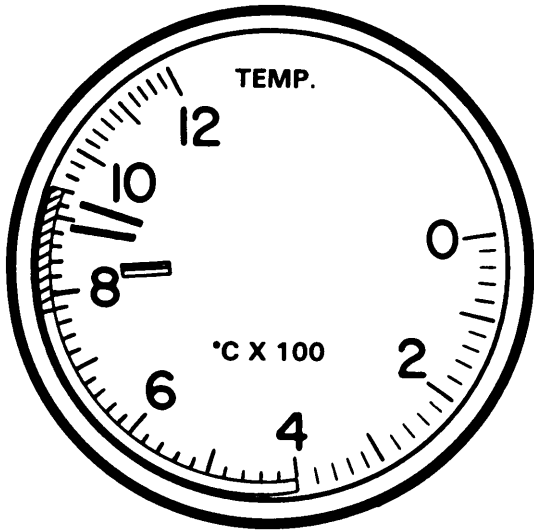


**712 TORQUEMETER**

- ▩ 100 PERCENT MAXIMUM DUAL ENGINE
- ▩ 123 PERCENT MAXIMUM SINGLE ENGINE

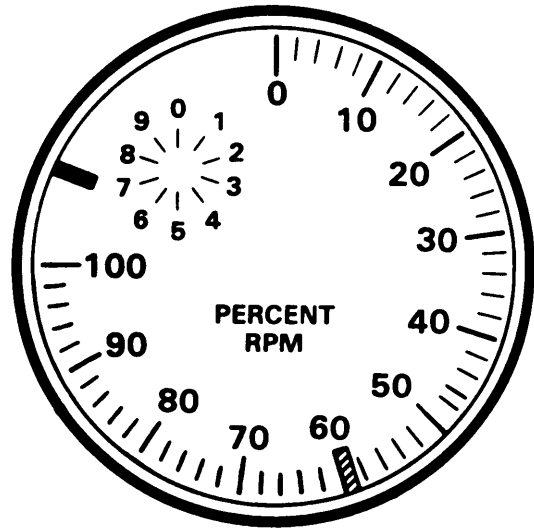
A73350

Figure 5-1. Instrument Markings (Sheet 1 of 5)



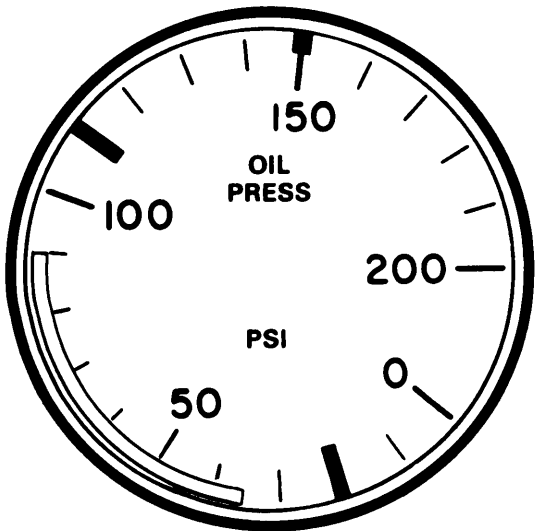
**POWER TURBINE INLET TEMPERATURE**

- 400°C TO 780°C CONTINUOUS OPERATION
- 810°C MAXIMUM FOR NOT MORE THAN 30 MINUTES
- 890°C MAXIMUM FOR NOT MORE THAN 10 MINUTES
- 781°C TO 940°C TIME-LIMITED OPERATION
- 940°C MAXIMUM, FOR NOT MORE THAN 12 SECONDS NEVER EXCEED 890°C TO 930°C EMERGENCY POWER (SINGLE ENGINE OPERATION) (REFER TO FIG. 5-2)



**GAS PRODUCER TACHOMETER**

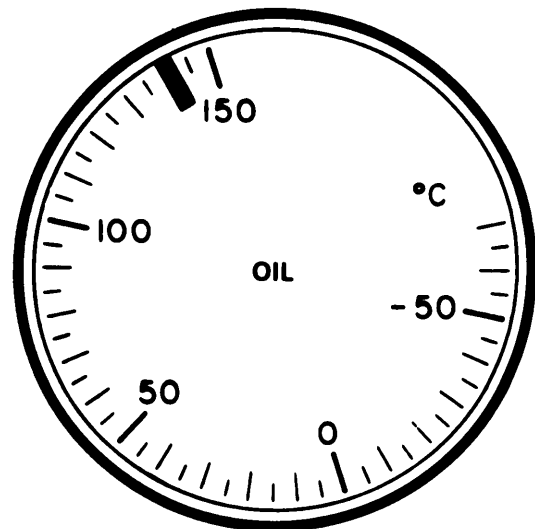
- 60 PERCENT MINIMUM GROUND IDLE
- 107 PERCENT MAXIMUM (SINGLE ENGINE) AND TRANSIENT



**ENGINE OIL PRESSURE**

**RANGE MARK LEGEND**

- GREEN
- YELLOW
- RED
- BLUE



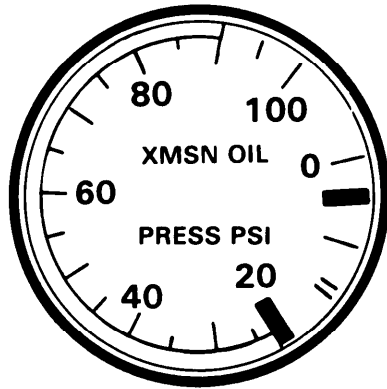
**ENGINE OIL TEMPERATURE**

- 20 PSI MINIMUM AT GROUND IDLE
- 35 PSI MINIMUM AT 80 TO 95% N1
- 50 PSI MINIMUM AT 95% N1 OR ABOVE
- 35 TO 90 PSI FOR NORMAL OPERATION
- 110 PSI MAXIMUM AT EMERGENCY POWER
- 150 PSI MAXIMUM FOR COLD WEATHER STARTS

- 140°C MAXIMUM

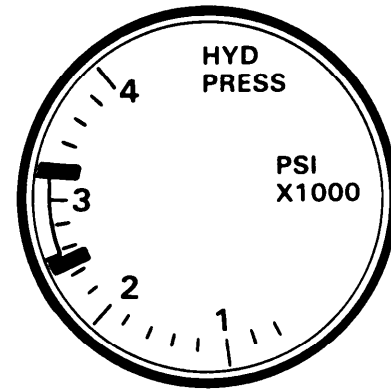
10516

Figure 5-1. Instrument Markings (Sheet 2 of 4)



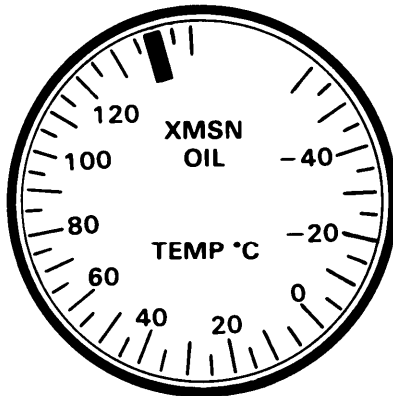
**TRANSMISSION OIL PRESSURE**

- 7 PSI MINIMUM AT GROUND IDLE
- 20 PSI MINIMUM
- 20 TO 90 PSI NORMAL OPERATION



**FLIGHT CONTROL HYDRAULIC PRESSURE**

- 2500 PSI MINIMUM
- 2500 TO 3200 PSI NORMAL OPERATION
- 3200 PSI MAXIMUM

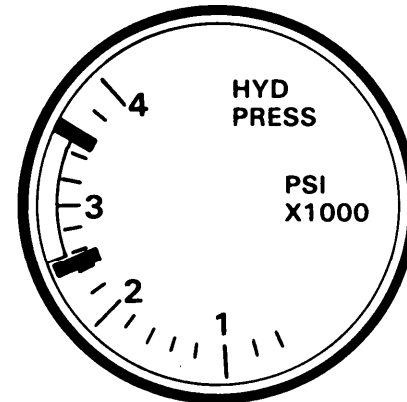


**TRANSMISSION OIL TEMPERATURE**

- 140°C MAXIMUM

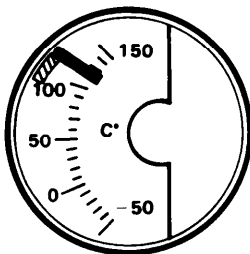
**RANGE MARK LEGEND**

- GREEN
- YELLOW
- RED



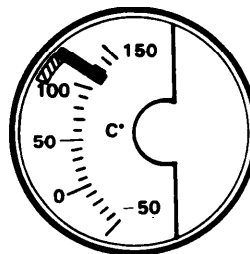
**UTILITY HYDRAULIC PRESSURE**

- 2500 PSI MINIMUM
- 2500 TO 3500 PSI NORMAL OPERATION
- 3500 PSI MAXIMUM



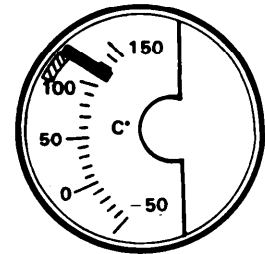
**NO. 1 FLIGHT CONTROL HYDRAULIC TEMPERATURE**

- 120°C MAXIMUM
- 95°C TO 120°C CAUTION



**NO. 2 FLIGHT CONTROL HYDRAULIC TEMPERATURE**

- 120°C MAXIMUM
- 95°C TO 120°C CAUTION

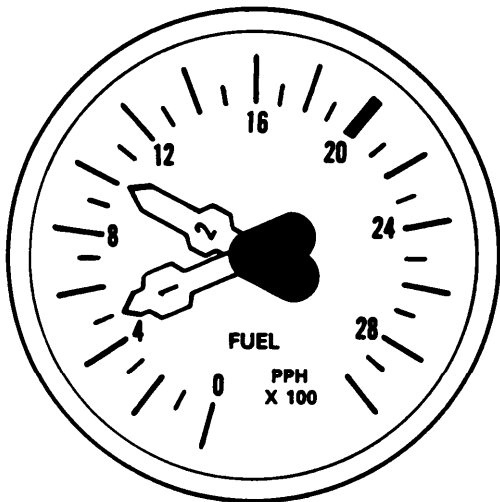


**UTILITY HYDRAULIC TEMPERATURE**

- 120°C MAXIMUM
- 95°C TO 120°C CAUTION

Figure 5-1. Instrument Markings (Sheet 3 of 4)





FUEL FLOW INDICATOR

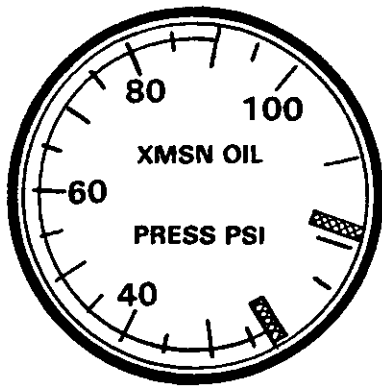
■ 2000 PPH 100% TORQUE

RANGE MARK  
LEGEND  
■ RED




FOR "FUEL FLOW LIMIT  
WITH TORQUE  
INDICATOR SYSTEM  
FAILURE" ONLY,  
DUAL ENGINE.

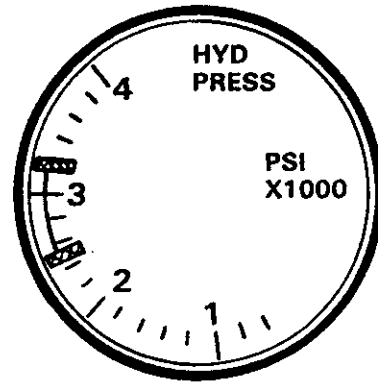
24939

Figure 5-1. Instrument Markings (Sheet 4 of 4)






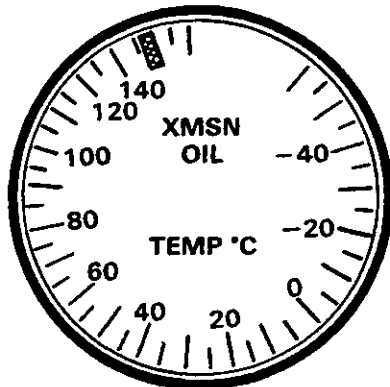
**TRANSMISSION OIL PRESSURE**

-  7 PSI MINIMUM AT GROUND IDLE
-  20 PSI MINIMUM
-  20 TO 90 PSI NORMAL OPERATION



**FLIGHT CONTROL HYDRAULIC PRESSURE**

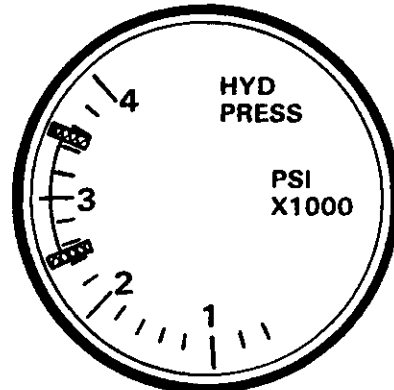
-  2500 PSI MINIMUM
-  2500 TO 3200 PSI NORMAL OPERATION
-  3200 PSI MAXIMUM






**TRANSMISSION OIL TEMPERATURE**

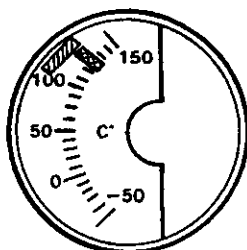
-  140°C MAXIMUM

- G 
- B 
- Y 
- R 



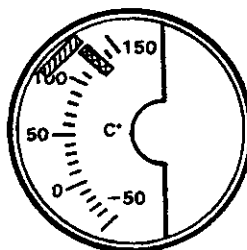
**UTILITY HYDRAULIC PRESSURE**

-  2500 PSI MINIMUM
-  2500 TO 3500 PSI NORMAL OPERATION
-  3500 PSI MAXIMUM



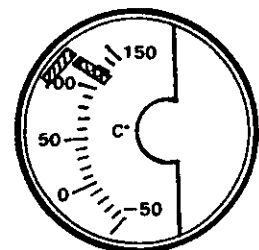
**NO. 1 FLIGHT CONTROL HYDRAULIC TEMPERATURE**

-  120°C MAXIMUM
-  95°C TO 120°C CAUTION





**NO. 2 FLIGHT CONTROL HYDRAULIC TEMPERATURE**

-  120°C MAXIMUM
-  95°C TO 120°C CAUTION



**UTILITY HYDRAULIC TEMPERATURE**

-  120°C MAXIMUM
-  95°C TO 120°C CAUTION

772000-A16863

Figure 5-1. Instrument Markings (Sheet 5 of 5)

### SECTION III POWER LIMITS

**5-10. Engine Rating and Power Level Limits.**

For variations in torque available with temperature and pressure altitude, refer to the Torque Available charts in Chapter 7.

**5-11. Emergency Power.**

Emergency power is only to be used during actual emergency conditions. After 30 minutes of emergency power time have accumulated, the engine must be inspected.

**5-12. Engine Limitations.** See fig. 5-1 for limitations. A gas producer (N1) overspeed exists when an N1 of

107 percent is exceeded. An N1 overspeed can cause overtemperature and/or overtorque. A power turbine (N2) overspeed may exist, depending on power being used, when 106 percent RRPM is exceeded.

**5-13. Engine Temperature Limitations.** See fig. 5-1 and 5-2.

**5-14. Fuel Limitations.** Only those fuels listed in Chapter 2 shall be used. Emergency fuel shall not be used for more than six hours cumulative time.

**5-15. Transmission Torque Limitations (Steady-State).** See fig. 5-1 for limitations.

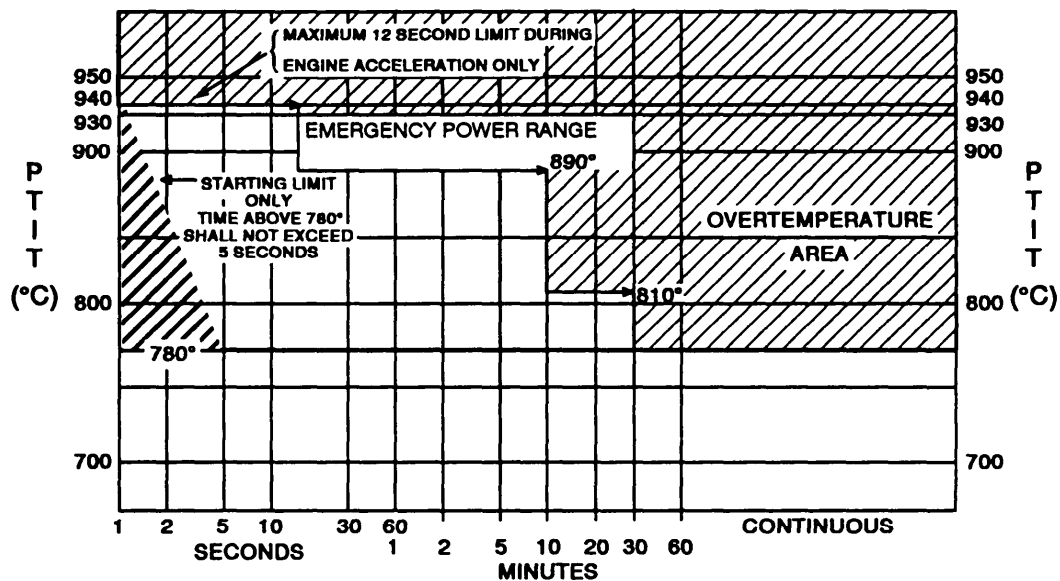


Figure 5-2. Operational PTIT Limits, T55-L-712 Engines

## SECTION IV LOADING LIMITS

### 5-16. Center-of-Gravity Limitations.

See fig. 6-25 for center-of-gravity (CG) limits in terms of gross weight (GW) and arm-inches (fuselage stations).

### 5-17. Maximum Gross Weight.

The maximum allowable operating gross weight is **50,000** pounds.

**5-18. Cargo Hook Limitations.** The limits presented below are structural limitations only.

a. The structural limit of the **forward** and **aft** hook is **17,000** pounds each.

b. The maximum single load that can be suspended as a **tandem** load from the **forward** and **aft** hooks is **25,000** pounds.

c. The **center** cargo hook is limited to a maximum load of **26,000** pounds.

### 5-19. Winch/ Rescue Hoist Limitations.

a. The winch shall not exceed:

- (1) **3,000** pounds, straight line pull.
- (2) **6,000** pounds, one pulley.
- (3) **9,000** pounds, two pulleys.
- (4) **12,000** pounds, three pulleys.

b. The rescue hoist is limited to a maximum load of **600** pounds.

c. Refer to Chapter 4 for system configuration and operation.

## Section V. AIRSPEED LIMITS

### 5-20. AIRSPEED OPERATING LIMITS.

#### 5-21. Airspeed Limitations With an Inoperative Cruise Guide Indicator.

The airspeed operating limits chart, fig. 5-5, shows the maximum allowable airspeeds with an inoperative cruise guide indicator.

#### 5-22. Airspeed Limitations With An Operative or Inoperative Cruise Guide Indicator.

The following airspeed limitations apply with an operative or inoperative cruise guide indicator:

- a. Maximum airspeed in **sideward** flight is **45** knots.
- b. Maximum airspeed in **rearward** flight is **45** knots.
- c. Maximum **crosswind** or **tailwind** for hover is **45** knots.
- d. Maximum airspeed with the lower section of the cabin entrance door open and locked is **60** KIAS.
- e. The rescue hatch door shall not be opened or closed above **90** KIAS. Otherwise the limitations specified in a. and b. above apply.
- f. The windshield wipers shall be shut off at airspeeds above **130** knots.
- g. Cabin door escape panel — assure that airspeed is less than **100** KIAS before closing door in flight.

#### 5-23. External Cargo Airspeed Limits.

**5-24. Mil-Van Type Loads.** Maximum airspeed with Mil-Van type load is dependent on load weight and rigging procedure. If a sling or hook should fail while carrying a tandem load, limit airspeed to a maximum of **60** KIAS. When carrying large external loads, such as the Mil-Van, maximum airspeed for sideward and rearward flight is **20** knots.

- a. Tandem rigging (fig. 5-3).
  - (1) Maximum airspeed for Mil-Van weight **up to 7000** pounds is **70** KIAS.
  - (2) Maximum airspeed for Mil-Van weight **from 7000** pounds to maximum load is **110** KIAS.
- b. Tandem rigging with forward redundant sling (fig. 5-4).
  - (1) Maximum airspeed for Mil-Van weight **up to 7000** pounds is **100** KIAS.
  - (2) Maximum airspeed for Mil-Van weight **from 7000** pounds to maximum load is at **Vh**.

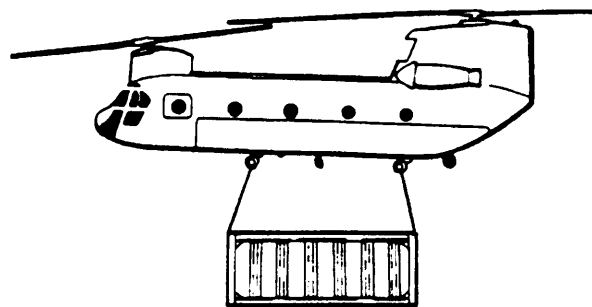


Figure 5-3. Tandem Hook Rigging Without Redundant Sling

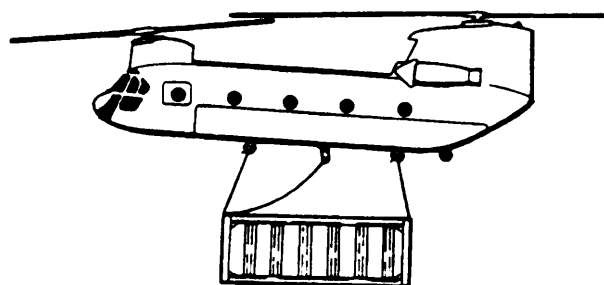


Figure 5-4. Tandem Hook Rigging With Forward Hook Redundant Sling

**5-25. High Density Loads.** Maximum airspeed with high density cargo (jeep, gamma goat, M114, M198) is dependent on load weight and rigging procedure.

#### a. Tandem rigging:

(1) Maximum speed for weights **up to 7000** pounds is **120** KIAS.

(2) Maximum speed for weights **from 7000** pounds to maximum weight is **Vh**.

b. Tandem rigging with forward redundant rigging or both forward and aft redundant rigging: Maximum airspeed is **Vh** for all weights up to maximum authorized.

#### 5-26. Longitudinal Cyclic Trim (LCT) Actuator Airspeed Limits.

The airspeed operating limits chart, fig. 5-6, shows the maximum allowable airspeeds with either LCT, fully retracted. Do not manually extend the LCT beyond the GND position on the cyclic trim indicators at indicated airspeeds below 60 knots. Use of extended cyclic trim at low airspeeds will result in high aft rotor blade stresses.

#### 5-27. Use of Airspeed Limitations Chart.

The use of these charts is illustrated by the example on each chart. To determine the maximum operating airspeed, it is necessary to know the free air temperature,

(FAT), pressure altitude, (PA), and gross weight, (GW). Enter the chart at known FAT, move right to known PA, move down following the graph lines to known GW, then move left and read maximum indicated airspeed. If the cruise guide indicator is inoperative, two airspeed limits must be determined and the lower limit used. One is the structural limit based on GW; the other is based on blade compressibility limit at lower temperatures. After determining the structural limit, move up or down to the dashed line representing FAT, then deflect left and read airspeed. This airspeed should be increased

for GW below **50,000** pounds. Go to the insert graph and enter it at known GW. Move right to the sloping line, then deflect down and read speed increase. To determine maximum operating airspeed, add this value to that previously determined.

**5-28. AFCS Limitations.**

The airspeed limit when operating on **single AFCS** is **100 KIAS** or Vne, whichever is slower. The helicopter may be operated with both AFCS off up to 160 KIAS or Vne, whichever is slower.

# AIRSPED OPERATING LIMITS

## WITH INOPERATIVE CRUISE GUIDE INDICATOR

PROGRAMMED LONGITUDINAL CYCLIC TRIM 100% ROTOR RPM

AIRSPED OPERATING LIMITS  
LIMITS  
CH-47D

### EXAMPLE

#### WANTED

MAX INDICATED AIRSPEED FOR GIVEN TEMP, PRESS ALTITUDE, AND GROSS WEIGHT

#### KNOWN

FAT = -30°C  
PRESS ALTITUDE = 8,800 FT  
GROSS WEIGHT = 36,000 LB

ENTER FAT AT = -30 °C  
MOVE RIGHT TO  
PRESS ALTITUDE = 8,600  
● MOVE DOWN TO GROSS WEIGHT LINE (38,000 LB), MOVE LEFT AND READ IAS = 148 KT  
● MOVE DOWN TO TEMP LINE (-30°C) MOVE LEFT AND READ IAS = 125 KT  
USE INSERT GRAPH TO ADJUST TEMP LIMIT SPEED FOR CHANGE IN GROSS WEIGHT.  
ENTER AT GW = 38,000 LB MOVE RIGHT, THEN DOWN TO READ INCREMENTAL SPEED INCREASE = 4.3 KT (IAS).  
NOW, IAS = 125 + 4 = 129 KT AT GROSS WEIGHT = 38,000 LB.

USE LOWER VALUE AS MAXIMUM IAS.

MAX IAS = 129 KT

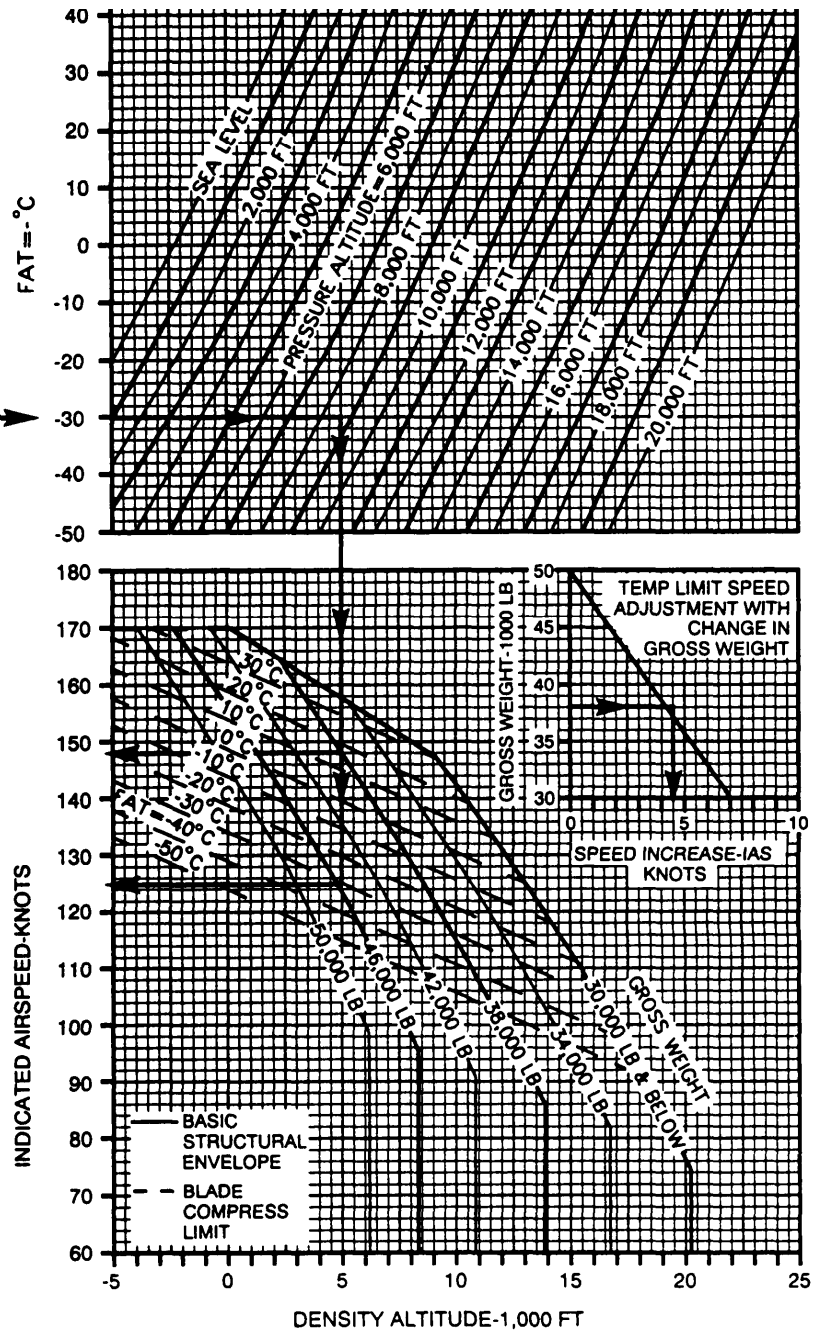


Figure 5-5. Airspeed Limitations - Inoperative Cruise Guide Indicator

A22865

# AIRSPEED OPERATING LIMITS

## WITH RETRACTED LONGITUDINAL CYCLIC TRIM

AIRSPEED  
OPERATING  
LIMITS  
CH-47D

NOTE: USE OF CRUISE GUIDE INDICATOR TO EXCEED THESE AIRSPEED LIMITS PROHIBITED

**EXAMPLE**

**WANTED**

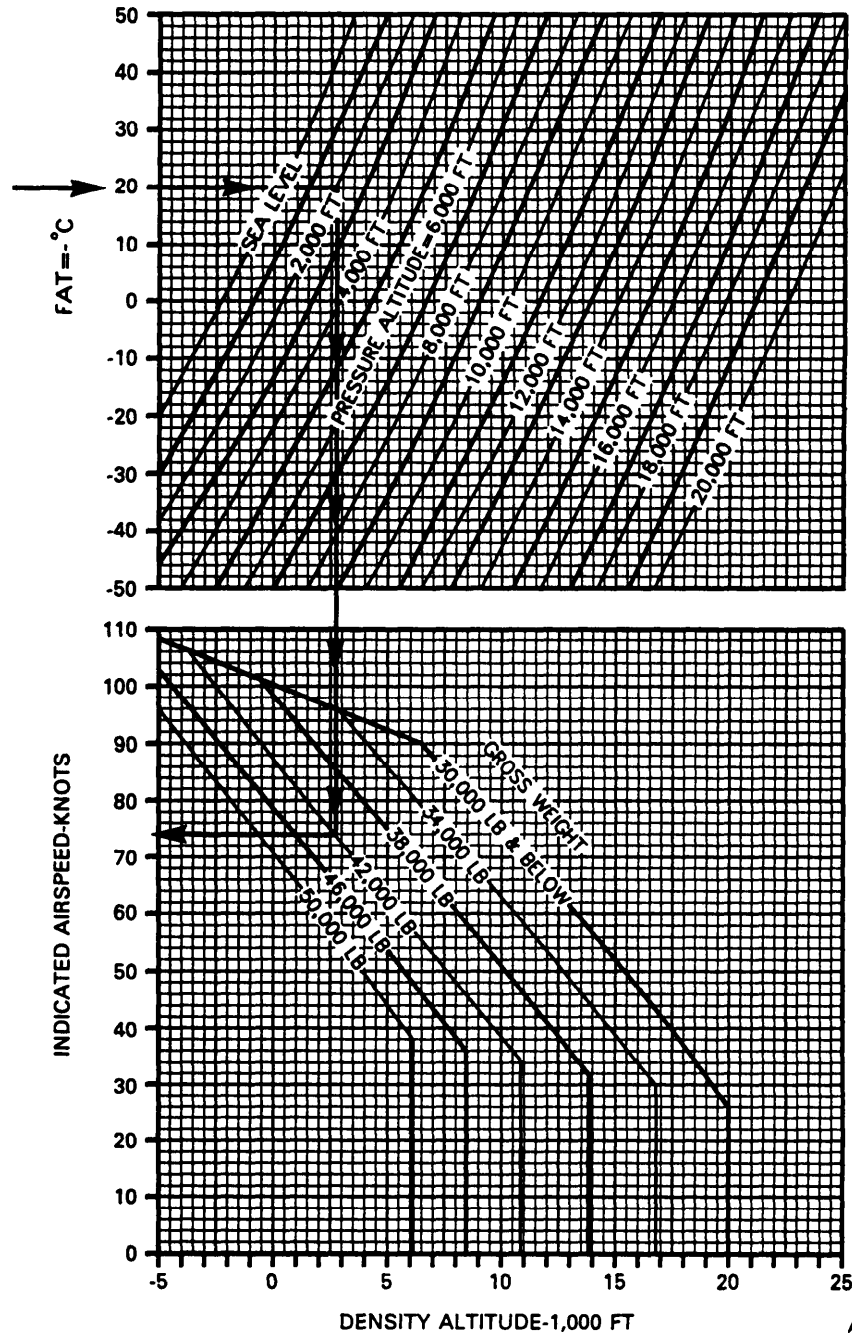
MAX INDICATED AIRSPEED FOR GIVEN TEMP, PRESS ALTITUDE, AND GROSS WEIGHT

**KNOWN**

FAT=20°C  
PRESS ALTITUDE = 2,000FT  
GROSS WEIGHT = 42,000 LB

**METHOD**

ENTER FAT AT 20°C, MOVE RIGHT TO PRESS ALTITUDE=2,000 FT  
MOVE DOWN TO GROSS WEIGHT LINE (42,000 LB), MOVE LEFT AND READ IAS=74 KT



A22866

Figure 5-6. Airspeed Limitations - Longitudinal Cyclic Trim Retracted



## SECTION VI MANEUVERING LIMITS

### 5-29. Aerobatics Prohibition.

Acrobatics are prohibited with this helicopter.

### 5-30. Bank Limitations.

The following bank angle limits apply:

a. With an operative cruise guide indicator, bank angles are as limited by the cruise guide indicator, but no greater than **60** degrees. When operating with **altitude hold**, limit bank angles to **45** degrees maximum.

b. With an inoperative cruise guide indicator, use the bank angle limits defined by fig. 5-7.

### 5-31. Landing Limitations.

a. The maximum rate of descent at touchdown for gross weights **up to 33,000** pounds is **492** feet per minute.

b. The maximum rate of descent at touchdown for gross weights **from 33,000 to 40,000** pounds is **450** feet per minute.

c. The maximum rate of descent at touchdown for gross weights **above 40,000** pounds is **360** feet per minute.

d. The maximum ground speed for running landings is **60** knots.

e. The maximum nose-up attitude during landings is **20°**.

### 5-32. Flight Control Limitations.

When operating at or above an airspeed of 100 knots, the thrust control is not to be lowered at a rate which exceeds 2.5 inches per second. There is no limiting rate for movement less than 2.0 inches.

### 5-33. Ground Operation Limitations.

a. To prevent droop stop pounding while taxiing, flight control movements are not to exceed **0.75** inch **right or left** for the directional pedals, **2 inches longitudinally aft** of neutral and **1.00 inch laterally right or left** for the cyclic stick, and not below the ground detent for the thrust control rod.

b. When ground taxiing less than **75** feet of an obstruction, a blade watcher and taxi director shall be positioned as shown in figure 8-1.

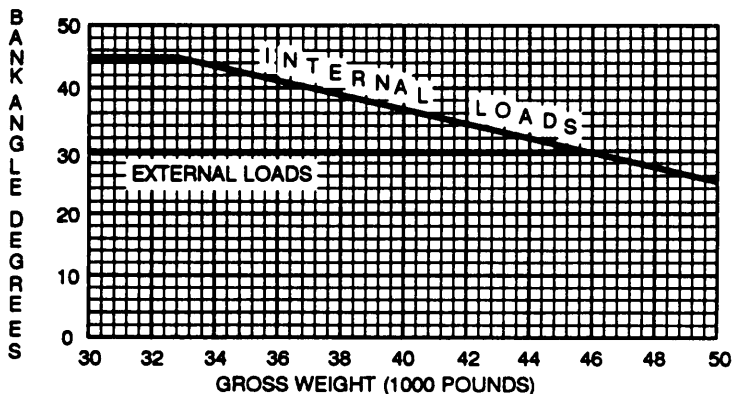


Figure 5-7. Bank Angle Limitations

**SECTION VII ENVIRONMENTAL RESTRICTIONS**

**5-34. Engine Inlet Screen Limitation.**

Refer to table 5-1 for information on engine bypass panel removal.

**5-35. Flight Under Instrument Meteorological Conditions (IMC).**

This helicopter is qualified for flight in instrument meteorological conditions provided the following conditions exist:

- a. Both AFCS are operational.

**NOTE**

Should one AFCS fail during IMC flight, the flight may be continued to destination. Should both AFCS fail during IMC flight, a landing should be made as soon as practical.

- b. Two vertical gyros and two vertical gyro indicators (VGI) are installed and operative.

**5-36. Flight in Ice.**

Pitot tube and Advanced Flight Control Systems (AFCS) yaw port heating, and windshield anti-icing systems

enable safe flight in light-icing conditions. Continuous flight in light-icing conditions below 5°C is not recommended since blade damage can occur from asymmetric ice shedding. Intentional flight into known icing conditions with rotor blade erosion protection materials installed is prohibited. Icing conditions include "trace," "light," "moderate," and "heavy."

**5-37. Thunderstorm Operation.**

To ensure adequate lightning strike protection, the lightning protection cables and straps must be installed and intact on all rotor blades. If any lightning cables or straps are missing or broken, avoid flight in or near thunderstorms, especially in areas of observed or anticipated lightning discharges.

**5-38. Operation With Skis.** If skis are installed, the following limits apply:

- a. The **maximum** allowable airspeed is limited to **130** knots indicated airspeed or Vne, whichever is lower, regardless of gross weight.
- b. The **maximum** allowable gross weight for **ground** operation is **50,000** pounds.
- c. The **maximum** allowable **rate of descent at touch-down** in snow is **480** feet per minute at gross weights up

**Table 5-1. Bypass Panel Removal Requirement**

Types of Icing Conditions	FREE AIR TEMPERATURE (°C)				
	4°C	-3°C -4°C	-18°C	-37°C -40°C	-53°C
Free Moisture or Liquid Water	Bypass Panels Removed			Probable Limit of Liquid Water	
				CAUTION Ice Accumulation Region	
Freezing Rain or Sleet		Probable Limit of Freezing Sleet	CAUTION Ice Accumulation Region		
		Bypass Panels Removed			
Snow		Wet Snow Region	Dry Snow Region		
		Bypass Panels Removed			

to 33,000 pounds, decreasing linearly to 240 feet per minute at 46,000 pounds gross weight. For gross weights 46,000 pounds to 50,000 pounds, the rate of descent is 240 feet per minute.

d. The maximum taxi speed is 5 knots when operating on hard prepared surfaces.

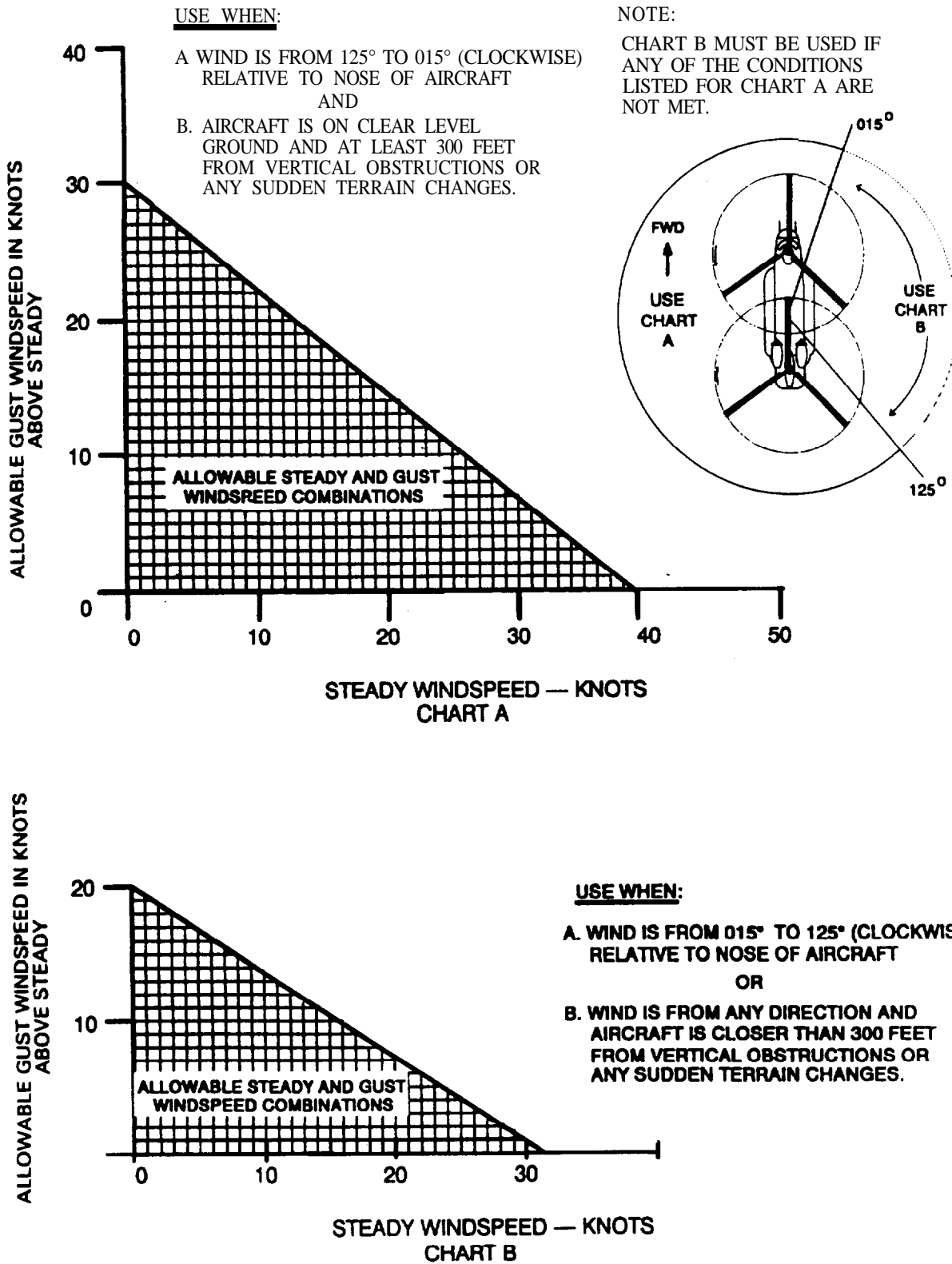


Figure 5-7.1. Rotor Blade Start-Up & Shutdown Limits

**SECTION VIII WATER OPERATION LIMITATIONS**

**5-39. WATER OPERATION LIMITATIONS.**

**5-40. Night Operation on Water.** Night operation on water is permissible provided:

- a. Both AFCS are operational.
- b. Pilot and copilot radar altimeter systems are operational.
- c. A visible horizon is present at the landing site.
- d. Two or more highly visible, stationary objects are on the water surface to provide necessary visual cues for landing.

**5-41. Sea State Limits.** Operation on water is restricted to a maximum of Sea State 2. Refer to table 5-2 for information on sea states.

**5-42. Operation Time Limit.** Operation on water is restricted to **30** minutes total flotation time without draining the helicopter.

**5-43. Gross Weight Limitations.** Maximum gross weight for water operations is as follows:

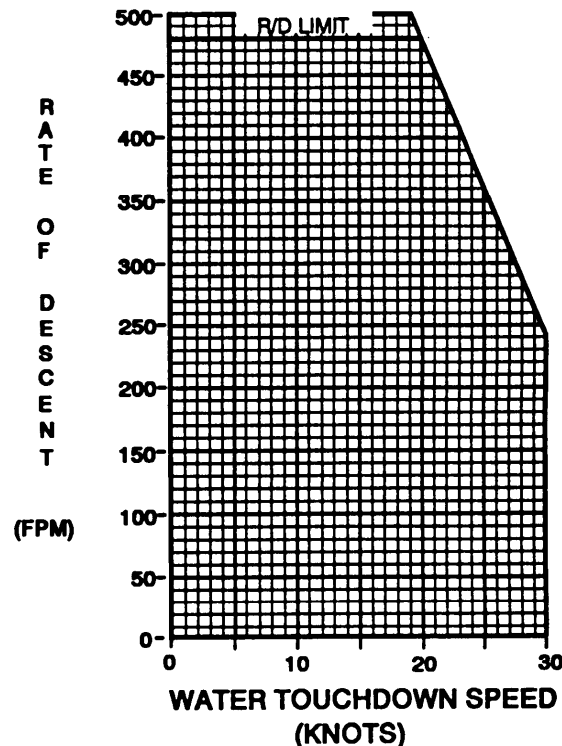
- a. Normal operations — **36,000** pounds.
- b. Emergency rescue missions – **46,000** pounds.

**5-44. Taxiing Limitations.** Taxiing will not be conducted in water conditions above Sea State 1 or in wind above 6 knots. Fast taxiing will be conducted in a straight line only and to a maximum speed of 10 knots when the lower nose enclosure is left in the water.

**5-45. Landing Limitations.** Water landings can be performed within the limitations presented on fig. 5-8. The touchdown speeds presented do not reflect indicated airspeed but actual forward velocity at touchdown. Running landings will only be conducted onto calm water. The ramp, lower rescue door, and main cabin door shall be closed during water landing. Water

landings are **prohibited** when fuel in the main tanks is less than **50** percent.

**5-46. Rotor Starting and Shutdown Limitations.** Rotor starting or shutdown will not be conducted when water conditions exceed Sea State 1 or wind exceeds 6 knots. Maximum gross weight for starting and shutdown is **28,550** pounds.



**Figure 5-8. Water Landing Speed Limitations lip To 46,000 Pounds Gross Weight**

**Table 5-2. Description of Sea States**

SEA STATE	SEA DESCRIPTION	WIND DESCRIPTION	WIND VELOCITY (KNOTS)	AVERAGE WAVE HEIGHT (FT)
0	Sea like a mirror (calm)	calm	Less than 1	0.0
0	Ripples with appearance of scales; no foam crests (smooth)	Light Air	1-3	0.05
1	Small wavelets; crests of glassy appearance, not breaking (slight)	Light Breeze	4-6	0.2
2	Large wavelets; crests begin to break; scattered whitecaps	Gentle Breeze	7-10	0.6
3	Small waves, becoming longer, numerous whitecaps (moderate)	Moderate Breeze	11-16	1.4

## SECTION IX ADDITIONAL LIMITATIONS

### 5-47. Additional Limitations.

### 5-48. Air-to-Ground Towing.

Air-to-ground towing operations are prohibited.

### 5-49. APU Operation.

APU operation in flight is prohibited except during emergencies.

### 5-50. Pitot Tube and AFCS Sideslip Port Anti-Icing Limitation.

The PITOT switch shall not be on for more than 5 minutes on the ground.

### 5-51. Single Point Refueling.

The maximum rate for pressure refueling is 300 gal/min at 55 psi.

### 5-52. Extended Range Fuel System (ERFS).

#### WARNING

Installing the non-crashworthy/non self sealing ERFS increases the potential for explosion and burn injuries during a crash. Therefore, the number of personnel on board the helicopter should be kept to the minimum required to perform the required mission.

Over water flights with ERFS should be limited to 5.6 hours.

#### NOTE

All CH-47D Aircraft are authorized for NVG use when delivered with the exception of aircraft S/N 84-24187 and prior which are required to have MWO 55-1520-240-50-3.

### 5-52.1. Extended Range Fuel System II (ERFS II).

The following paragraphs contain important operating limits and restrictions that shall be observed during the operation of the ERFS II. Compliance with these limits will allow the operator to safely perform the assigned missions and derive the maximum utility from the ERFS II.

### 5-53. Maximum Capacity and Usable Fuel.

The maximum capacity of one ERFS II tank assembly is 825.5 US Gallons.

The usable fuel in one ERFS II tank assembly is 800 US Gallons when single point pressure refueled.

#### NOTE

the usable fuel may be increased by 20 US Gallons if the ERFS II tank is gravity refueled.

### 5-54. Maximum Pressure Refueling Rate.

The maximum pressure refueling rate should not exceed 300 GPM.

### 5-55. Maximum Fuel Pressure.

The maximum fuel pressure should not exceed 55 PSI.

### 5-56. Maximum Internal Pressure.

#### CAUTION

Trying to pressure refuel the tanks without connecting the vent lines could over pressurize the tanks.

The maximum pressure inside the ERFS II tank should not exceed 5 PSI.

### 5-57. Maximum Suction Defueling Pressure.

#### CAUTION

Conducting suction defueling at pressures greater than -11 PSIG could damage the internal components of the ERFS II tank assembly.

The maximum allowable suction defueling pressure is -11 PSIG.

## CHAPTER 6

# WEIGHT/BALANCE AND LOADING

### SECTION I GENERAL

#### 6-1. Purpose.

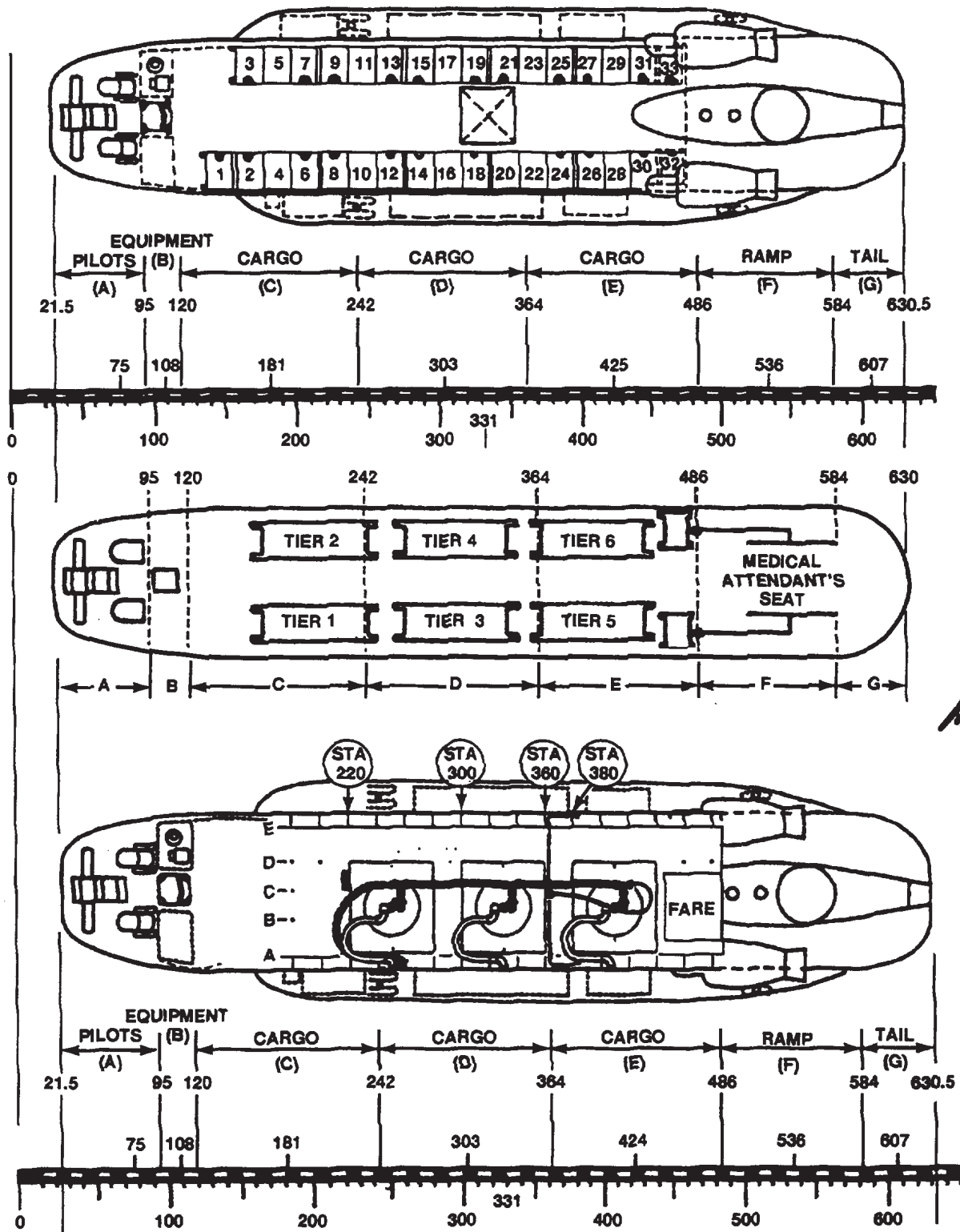
This chapter contains sufficient instructions and data so that the aviator, knowing the basic weight and moment of the helicopter, can compute any combination of weight and balance.

#### 6-2. Helicopter Compartment and Loading Diagram.

Figure 6-1 defines the compartments, shows the reference datum line, and depicts other information essential for helicopter weight/balance and loading.

#### 6-3. Classification of Helicopter.

Army Model CH-47D is in Class 1. Additional directives governing weight and balance of Class 1 aircraft forms and records are contained in AR 95-3, TM 55-1500-342-23, and DA PAM 738-751.



NOTE:  
INCHES FROM REFERENCE DATUM  
IDENTICAL TO STATION NUMBERS

A59126

Figure 6-1. Aircraft Compartment and Loading Diagram

## SECTION II WEIGHT AND BALANCE

### **6-4. DD Form 365-3 Chart C - Basic Weight and Balance Record.**

Chart C is a continuous history of the basic weight and moment resulting from structural and equipment changes in service. At all times, the last weight and moment/1,000 are considered the current weight and balance status of the basic helicopter.

### **6-5. DD Form 365-4 (Weight and Balance Clearance Form F).**

This form is used to derive the gross weight and center-of-gravity (C. G.) of the helicopter. The FORM F furnishes a record of the helicopter weight and balance status at each step of the loading process. It serves as a worksheet on which to record weight and balance calculations and any corrections that must be made to

insure that the helicopter will be within weight and C.G. limits. Sufficient completed FORMS F must be onboard the helicopter to verify that the weight and C.G. will remain within allowable limits for the entire flight. Sufficient forms can be one (for a specific flight) or it can be several. Several FORMS F for various loadings of crew, passengers, stores, cargo, fuel slingloads, etc., which result in extreme forward and extreme aft C.G. locations and variations in gross weight, but which remain within limits. There are two versions of this form: Transport and Tactical; they are designed to provide for the respective loading arrangements of these two type aircraft. The general use and fulfillment of either version are the same. Specific instructions for filling out the form are given in TM 55-1500-342-23.



### SECTION III FUEL/OIL

**6-6. Fuel and Oil Data.**

The CH-47D is equipped with six fuel tanks and an integral oil tank on each engine. The capacities of each fuel tank and each engine oil tank are given in chapter 2.

**6-7. Fuel Weight and Moment.**

Fuel moments for the forward auxiliary, main and aft auxiliary fuel tanks are shown in Figure 6-2. The fuel arms for these tanks are constant thus, for a given weight of fuel there is no variation in fuel moment with change in fuel specific weight. The common auxiliary fuel tank arm is 314.

The full tank usable fuel weight will vary depending upon fuel specific weight. The gallon scales on figure 6-2 are based on JP-4@ 6.5 lb/gal, JP-5@ 6.8 lb/gal, and JP-8 @ 6.7 lb/gal. The aircraft fuel gage system was designed for use with JP-4, but does tend to compensate for other fuels and provide acceptable readings. When possible the weight of fuel onboard should be determined by direct reference to the aircraft fuel gages.

The following information is provided to show the general range of fuel specific weights to be expected: Specific weight of fuel will vary depending on fuel temperature. Specific weight will decrease as fuel temperature rises and increase as fuel temperature decreases at the rate of approximately 0.1 lb/gal for each 15°C change. Specific weight may also vary between lots of the same type fuel at the same temperature by as much as 0.5 lb/gal. The following approximate fuel specific weights at 15°C may be used for most mission planning.

Fuel Type	Specific Weight
JP-4	6.5 lb/gal
JP-5	6.8 lb/gal
JP-8	6.7 lb/gal

**6-8. Oil Data.**

For weight and balance purposes, the weight of engine oil is included in the basic weight.

FUEL MOMENTS  
CH-47D

JP-5 FUEL GALLONS	JP-4 FUEL GALLONS	FUEL WEIGHT POUNDS
-------------------------	-------------------------	--------------------------

FUEL MOMENT/1000

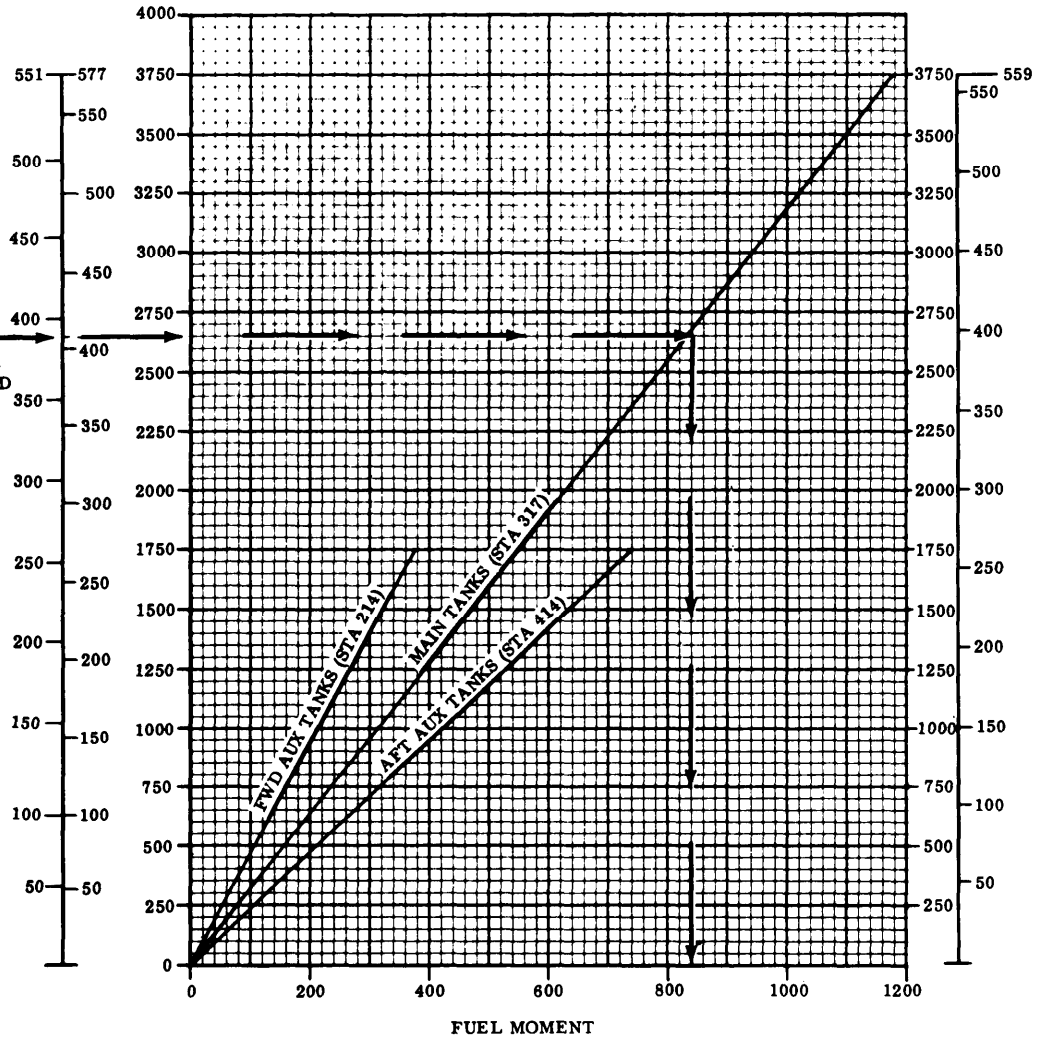
FUEL WEIGHT POUNDS	JP-8 FUEL GALLONS
--------------------------	-------------------------

**EXAMPLE**

**WANTED**  
FUEL MOMENT/1000

**KNOWN**  
FUEL WEIGHT =  
2625 POUNDS  
(404 GALLONS JP-4)

**METHOD**  
ENTER FUEL  
WEIGHT HERE →  
MOVE RIGHT TO TANK  
DEFLECT DOWN. READ  
FUEL MOMENT = 833



22896

Figure 6-2. Fuel Moment Chart

## SECTION IV PERSONNEL

### 6-9. Personnel Loading and Unloading.

The loading procedures should be accomplished and observed before loading to ensure the safety and comfort of personnel to be airlifted:

- a. Passenger compartment – Clean.
- b. Equipment – Stow and secure.
- c. Troop seats – Install, as required.
- d. Litters – Install, as required.
- e. Static line anchor cable – Install, as required
- f. Safety belts – Check, attached.
- g. Emergency equipment – Check.
- h. Emergency exits – Inspect.
- i. Special equipment – Check.

**6-10. Personnel Weight Computation.** When the helicopter is to be operated at critical gross weights, the exact weight of each individual occupant plus equipment should be used. If weighing facilities are not available, or if the tactical situation dictates otherwise, loads shall be computed as follows:

- a. Combat equipped soldiers – 240 pounds per individual.
- b. Combat equipped paratroopers – 260 pounds per individual.
- c. Litter patient (including litter, splints, etc.) – 200 pounds per individual.
- d. Medical attendants – 200 pounds per individual.
- e. Crew and passengers with no equipment – Compute weight according to each individual's estimate.
- f. Refer to figure 6-3 or 6-4 for personnel or litter patient moment data. The chart (fig. 6-3) provides precomputed moments for each troop seat position.

### 6-11. Seating Arrangement.

Seating arrangement for 33 fully equipped ground troops is provided by ten 3-man seats and three 1-man seats (fig. 6-5). A row of five 3-man seats is installed along each side of the cargo compartment. One-man seats are installed at the forward and aft ends of the left-hand row of seats and one at the aft end of the right-hand row of seats.

### 6-12. Troop Seats.

These seats are made of nylon on tubular aluminum frames and are joined together for greater rigidity and comfort. The seats are joined by means of slide bolt fasteners in the front seat tubes, zipper fasteners on the underside of the seat fabric, and snap fasteners along the vertical edges of the seat-back rests. A slide adjuster below the back rest hanger clips affords adjustment of

back rest tension. Seat tension is adjusted by relocating retaining pins in the holes drilled in the front seat tubes. A row of male snap fastener studs along the rear of the seat-back rest matches a row of female snap fastener sockets along the rear edge of the seat fabric. These fasteners are jointed to provide greater seat depth for troops equipped with parachutes. Two stowage straps are attached to the underside of the seat fabric; one is equipped with a hanger clip for folded stowage, the other is equipped with a buckle for rolled stowage. The seats will normally be stowed in the folded position for cargo transport.

A 2,000 -pound-capacity nylon web safety belt is provided for each seat occupant. The belt is adjustable and is equipped with a positive-grip buckle fastener designed for quick release.

**6-13. Troop Seat Installation.** Install the troop seats from the rolled position as shown in figure 6-6. Install troop seats from the folded position by performing steps 1, 4, 6, and 7 of figure 6-6.

**6-14. Troop Seat Stowage.** Stow the troop seats in the rolled position by performing steps 1 through 9 in reverse order as set forth in figure 6-6. Stow troop seats in the folded position by reversing the procedures in steps 7, 6, 4, and 1 of figure 6-6.

**6-15. Troop Loading.** The loading and unloading of troops will normally be accomplished through the lowered aft cargo door and ramp. The most orderly and efficient troop loading procedure is for the troops to occupy seats from the front to the rear. In unloading, the troops will leave the helicopter progressively from the rear to the front. If the troops to be loaded are carrying full field equipment, it is recommended that the seat-back rests be folded to avoid entanglement with the equipment and damage to the seat back rests.

### 6-16. Troop Commander's Jump Seat.

A collapsible fold-away seat is located in the cockpit entrance for the use of the troop commander. The seat is made of nylon on a tubular aluminum frame.

### 6-17. Litter Arrangement.

There are provisions for 24 litters, three tiers, four high, along each cargo compartment wall normally occupied by the troop seats (fig. 6-5). The two 1-man seats in the aft section of the cargo compartment may remain in place to serve as seats for medical attendants. If needed, the 1-man seat in the forward section of the cargo compartment may also remain. It is not necessary to remove the troop seats to install the litters.

**6-18. Litter Support Brackets.** Refer to figure 6-7 for litter installation. Four litter support brackets are permanently attached to each litter pole and each litter

# PERSONNEL MOMENTS

## EXAMPLE

**WANTED**  
PERSONNEL MOMENT

**KNOWN**  
PERSONNEL WEIGHT  
=240 POUNDS  
SEAT POSITION IS  
TROOP COMMANDER  
SEAT.

**METHOD**  
ENTER WEIGHT  
OF EACH SEAT  
POSITION HERE.  
MOVE RIGHT TO SEAT POSITION.  
MOVE DOWN READ  
MOMENT=25

PERSONNEL MOMENTS  
CH-47D

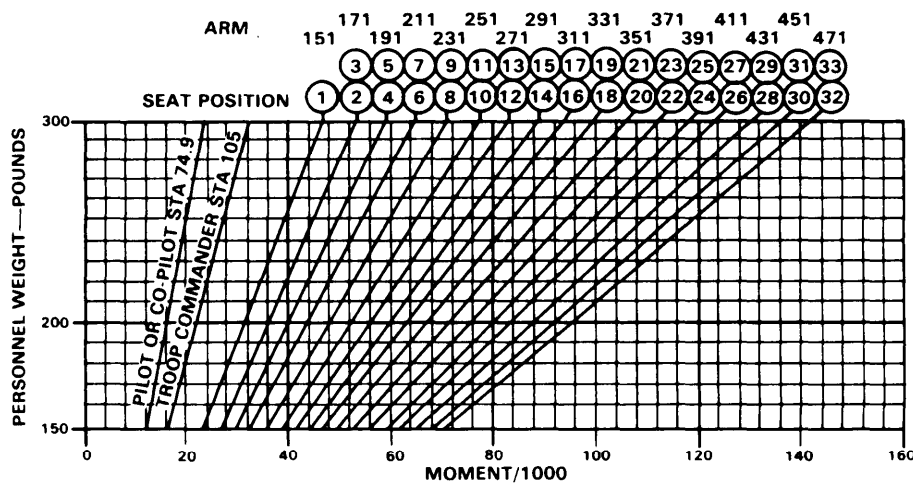
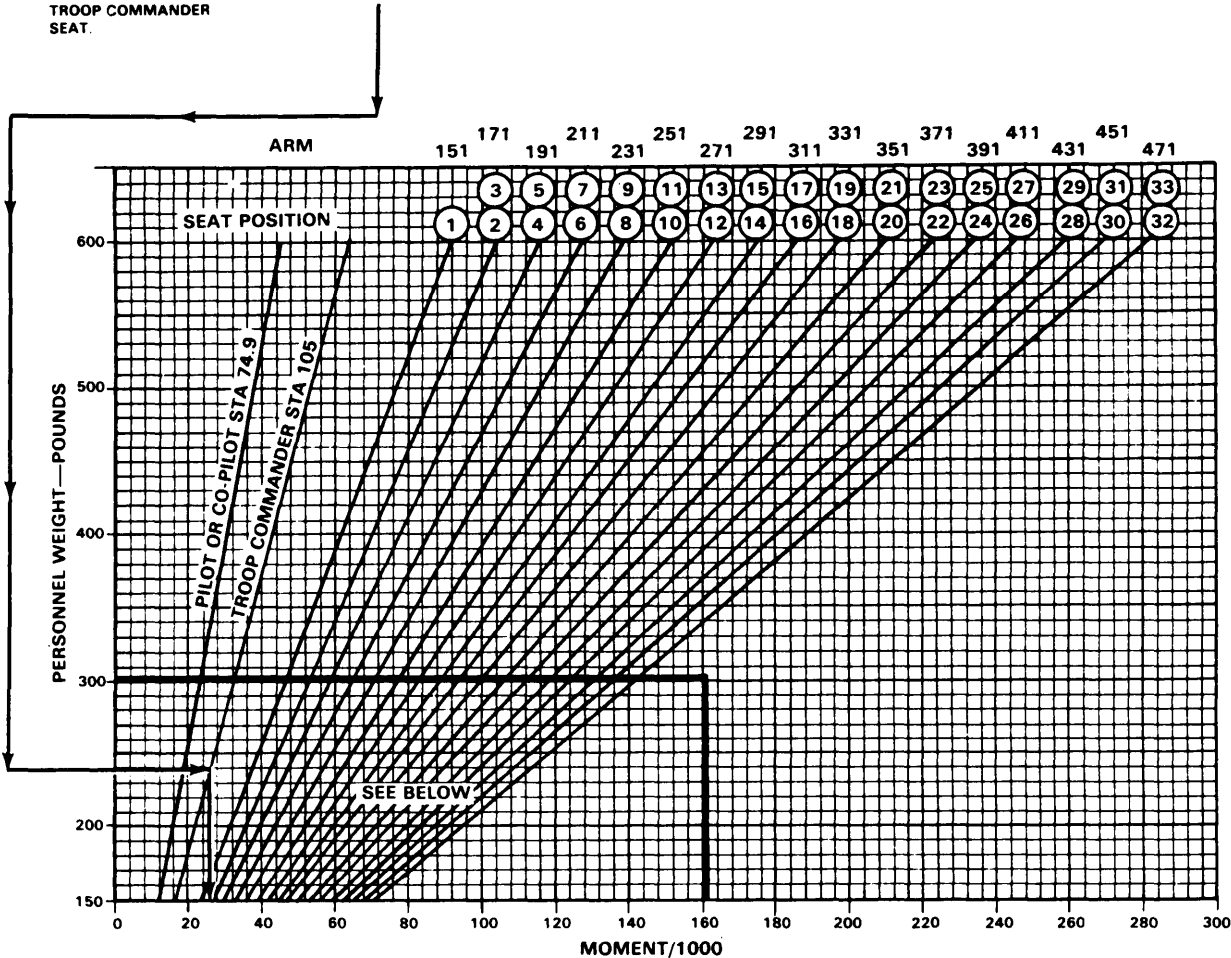


Figure 6-3. Personnel Moments

EXAMPLE:

WANTED  
Patient moment

KNOWN

Patient weight = 800 pounds. Tier position is No. 5

### LITTER PATIENT MOMENTS

LITTER PATIENT MOMENTS  
CH-47 D

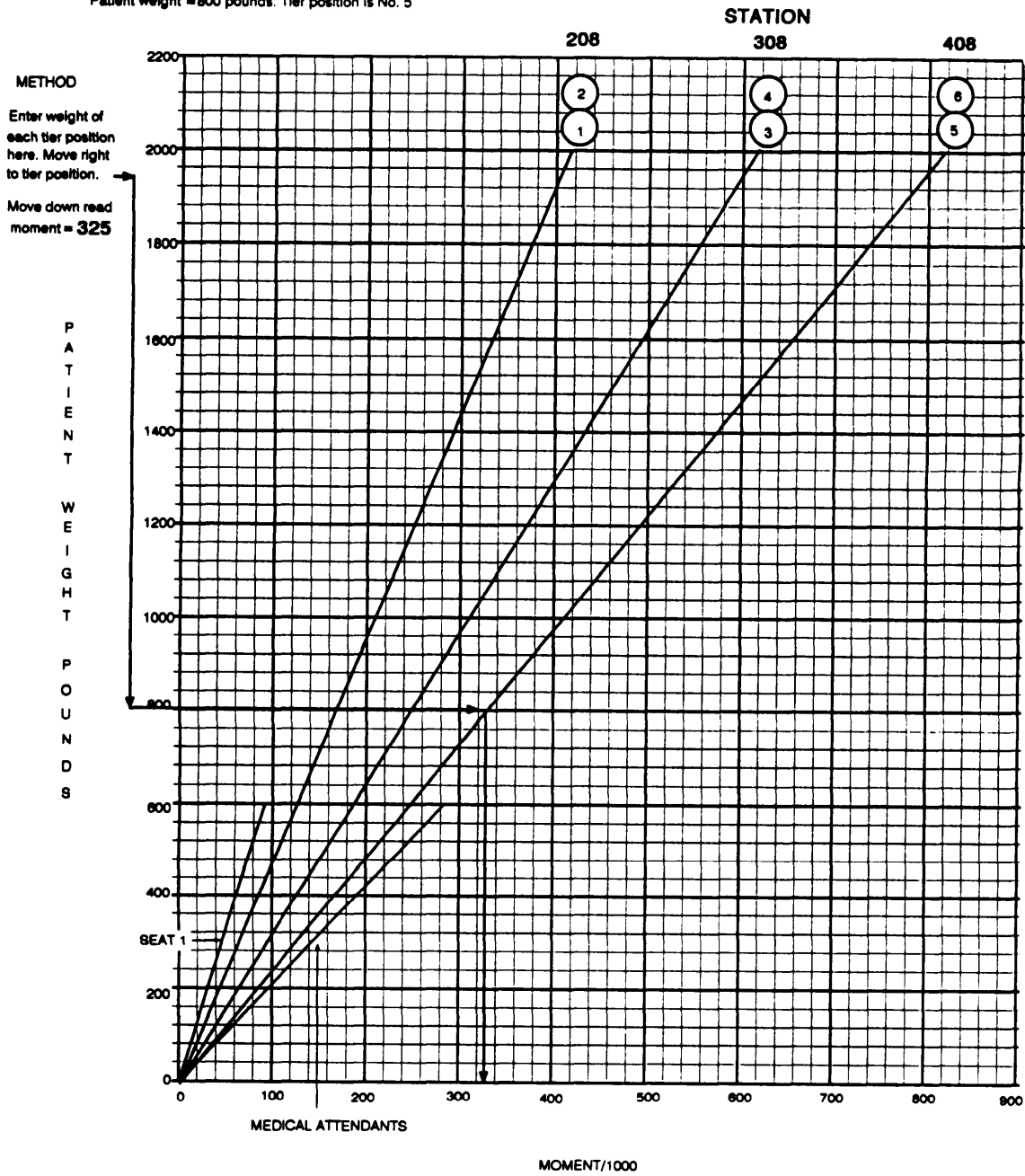


Figure 6-4. Litter Patient Moments

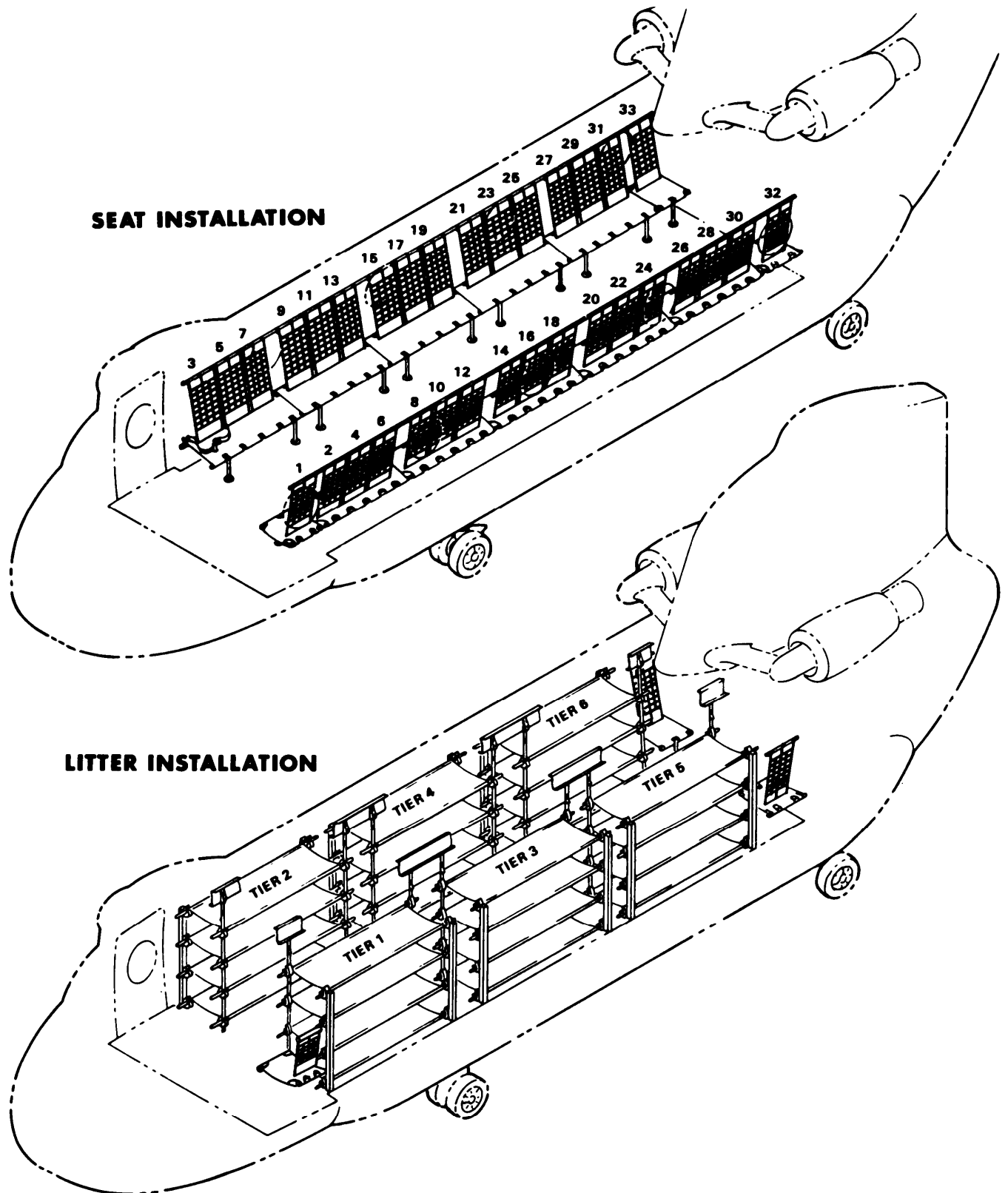
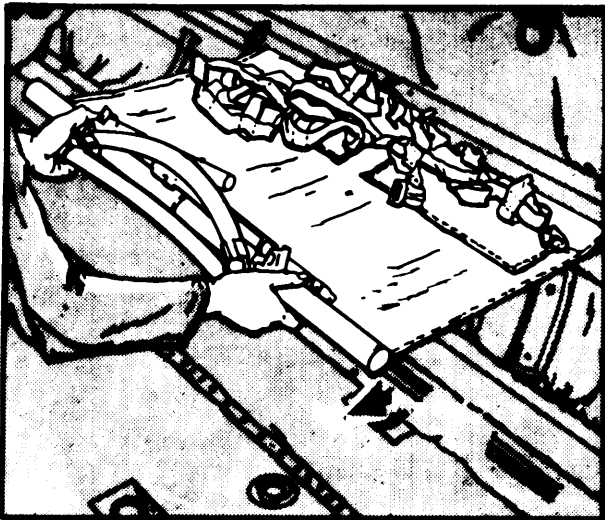
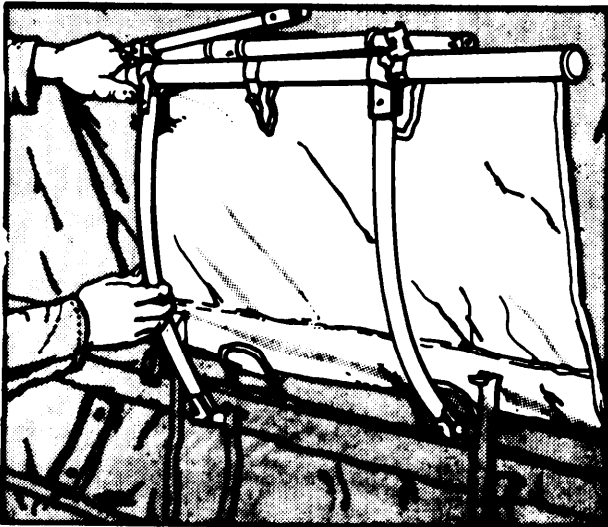


Figure 6-5. Troop Seats and Litters

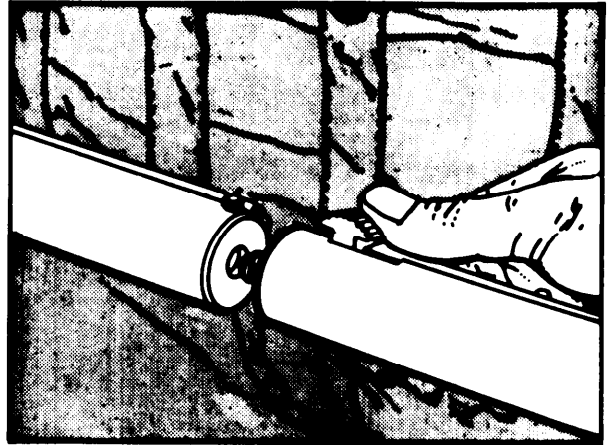
1 Unbuckle, unroll, and extend the seat.



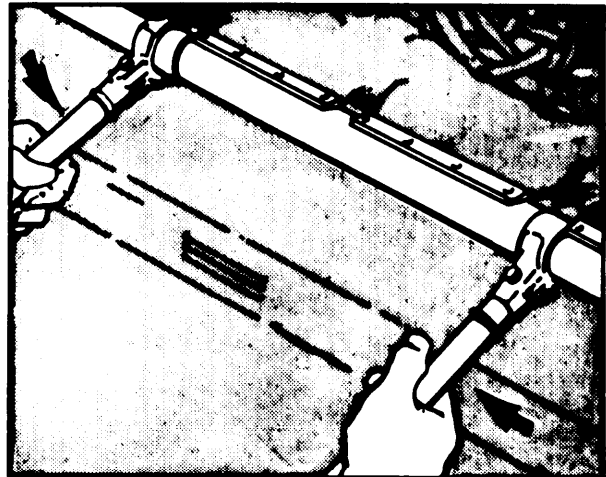
2 Swing the spreader tubes into position, and engage the end of each spreader with the clip on the rear seat tube.



3 Join the front seat tubes and zipper the seats together to form one continuous seat.



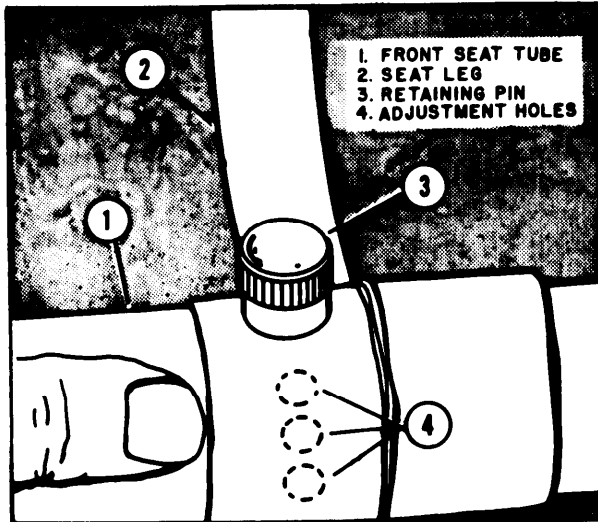
4 Swing the seat legs toward the perpendicular position until they lock in this position.



14852

Figure 6-6. Troop Seat Installation (Sheet 1 of 2)

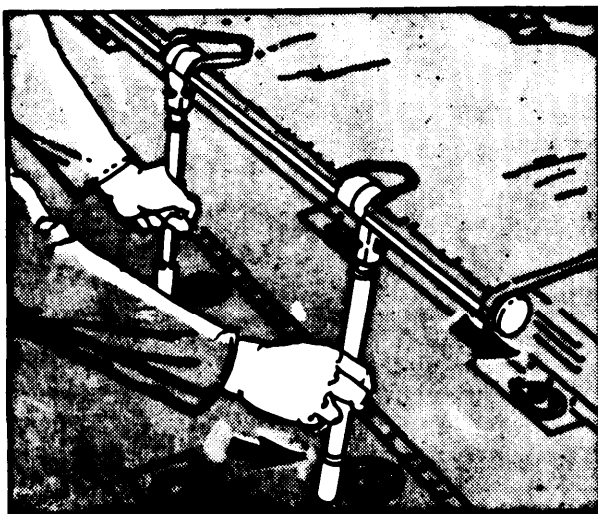
- 5 Adjust seat tension by engaging the spring-loaded retaining pin on the upper fitting of each seat leg in any one of four holes drilled around the front seat tube. The top hole gives the greatest tension, and the bottom hole adjusts the seat in its most relaxed position.



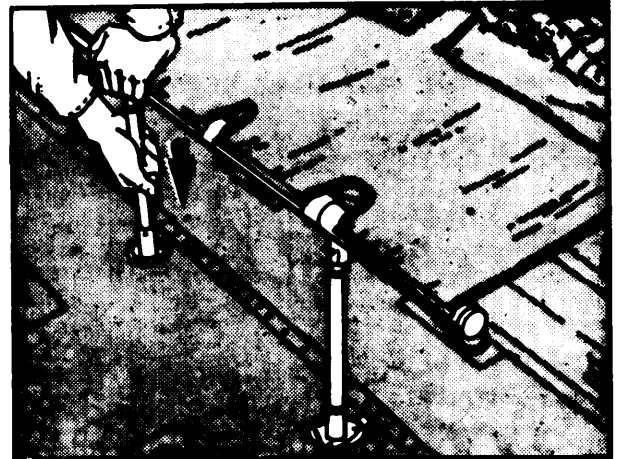
Note

Be sure the seat fabric is tightly stretched. If it is too loose, the seat will sag and the occupant will be uncomfortably seated on the spreader tube.

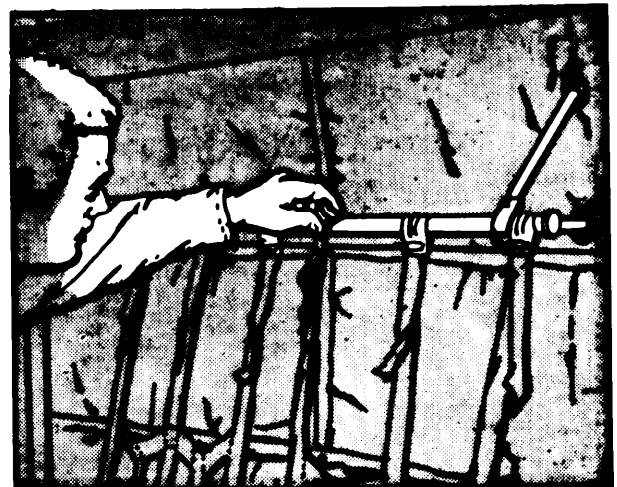
- 6 Apply tension to the seat by revolving the legs downward.



- 7 Place the legs directly over the studs on the floor and push down until the legs lock in place.



- 8 Attach the seat-back clips to the seat-back support tube.



- 9 Fasten the seat-back snap fasteners to form one continuous back rest.

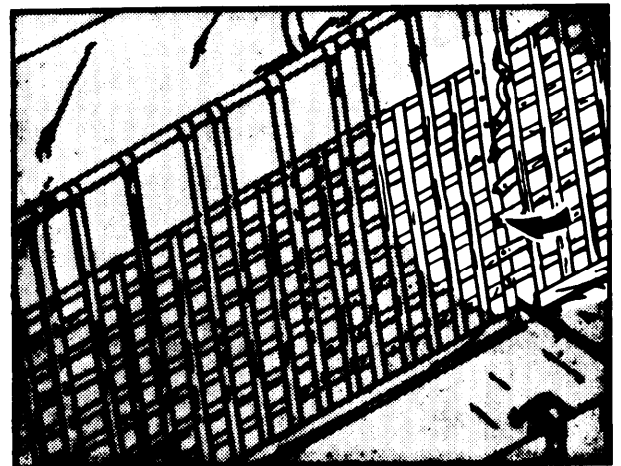
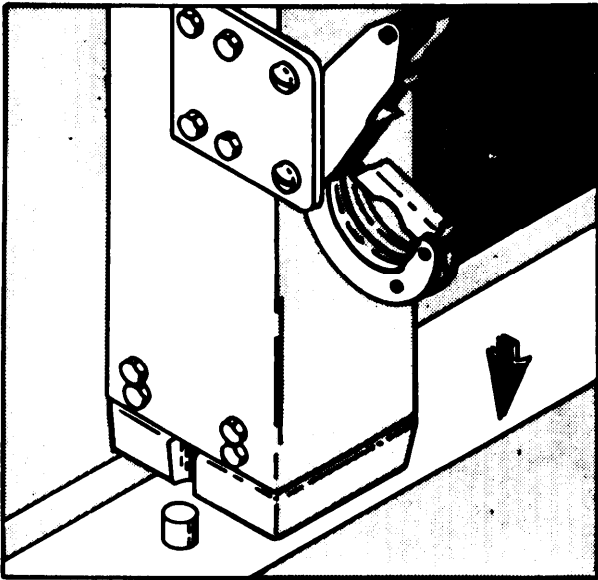


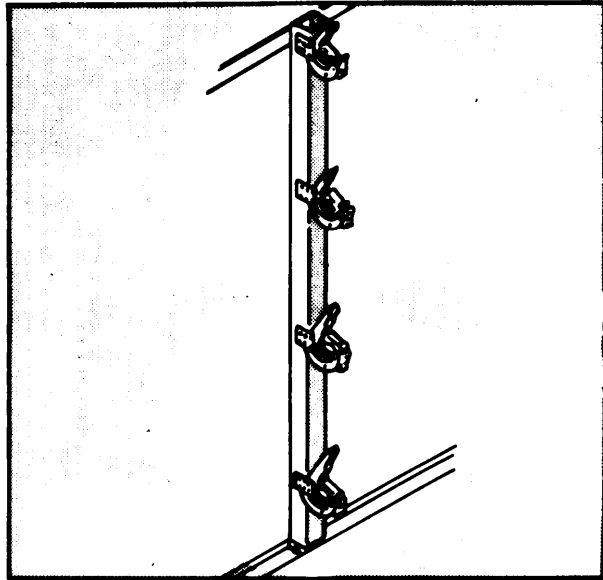
Figure 6-6. Troop Seat Installation (Sheet 2 of 2)



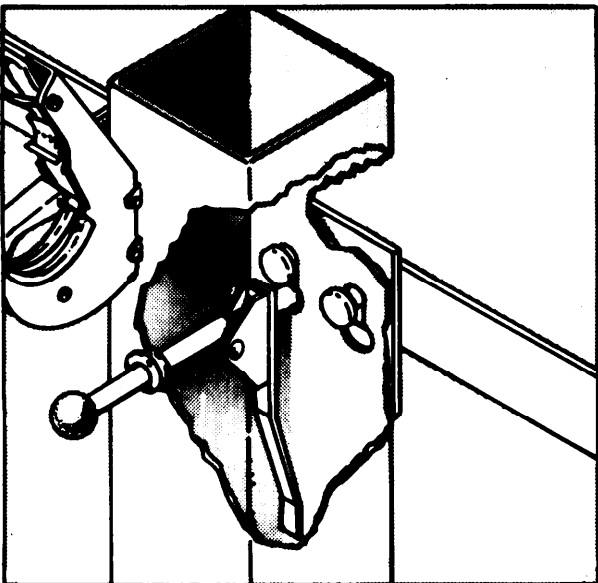
1. Stand the litter pole in the floor channel with the bottom pole attachment seated between the two studs located there.



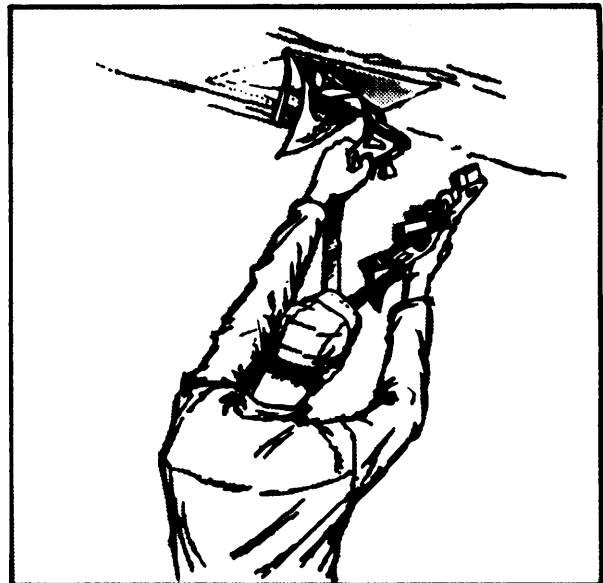
3. Move the litter pole downward until it is secured in position.



2. Swing the upper end of the litter pole against the studs on the seat-back support tube and fit the keyhole slots on the back of the pole over the studs.



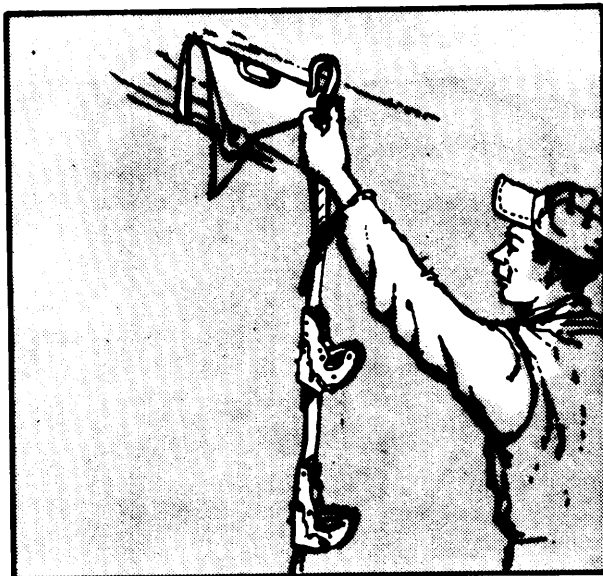
4. Remove all the litter support straps from the stowage recesses.



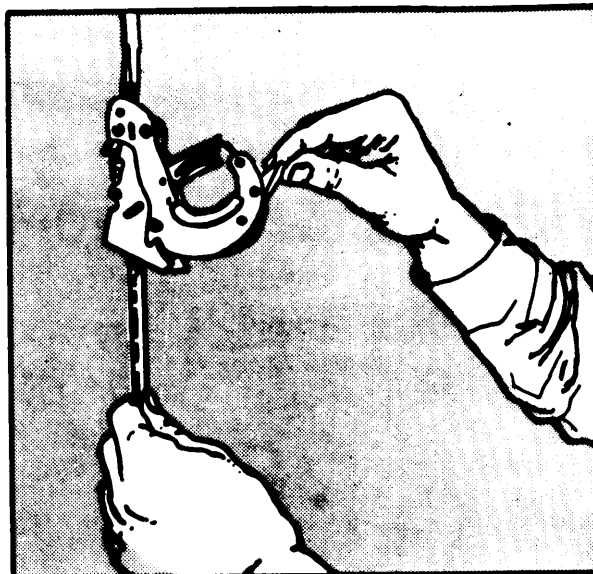
14854

Figure 6-7. Litter Installation (Sheet 1 of 3)

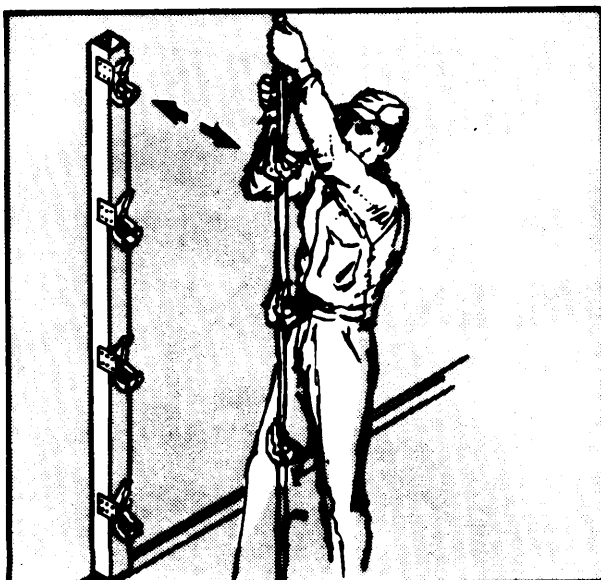
5 Attach the top ends of the straps to the brackets inside the stowage recesses.



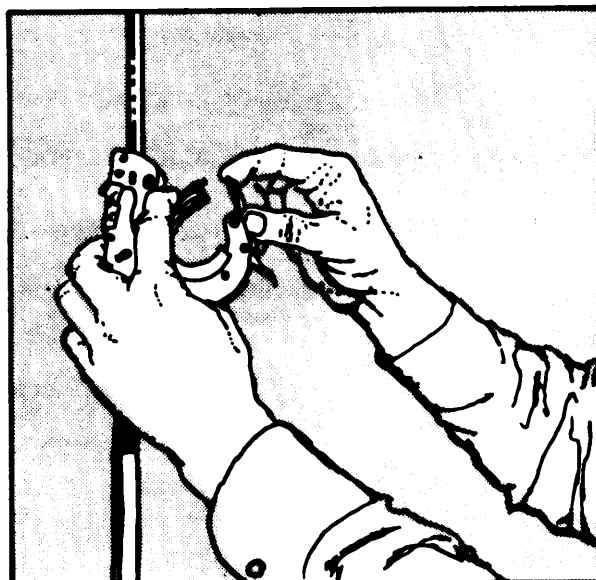
7 Pull down on the locking handle of the litter support bracket.



6 Adjust each strap upward and downward until the strap support brackets are the same height as those on the corresponding litter poles.



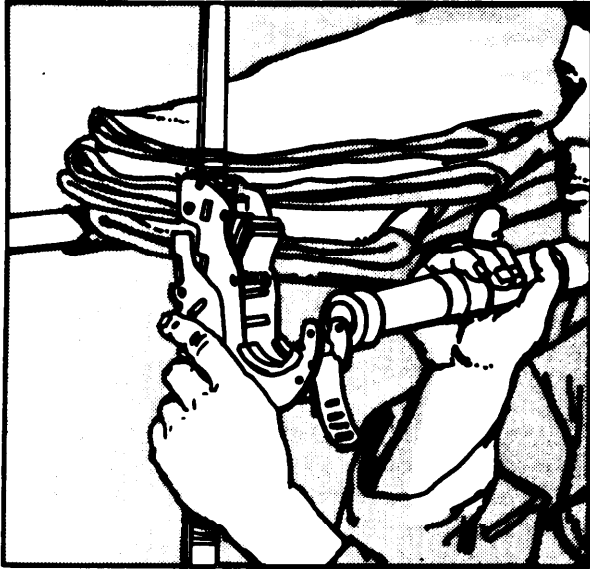
8 Pull the handle clip away from the locking bar.



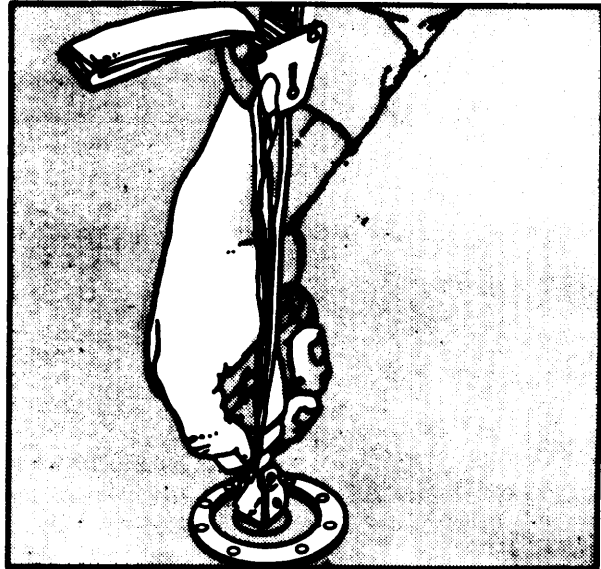
14855

Figure 6-7. Litter Installation (Sheet 2 of 3)

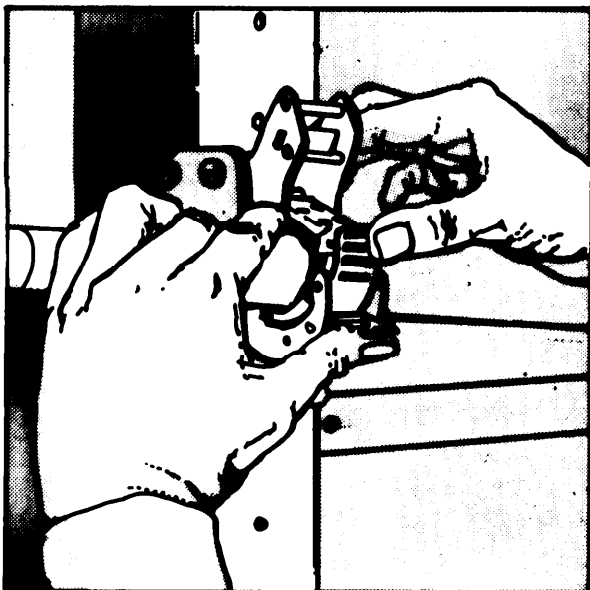
9 Place the litter handles into the litter support brackets.



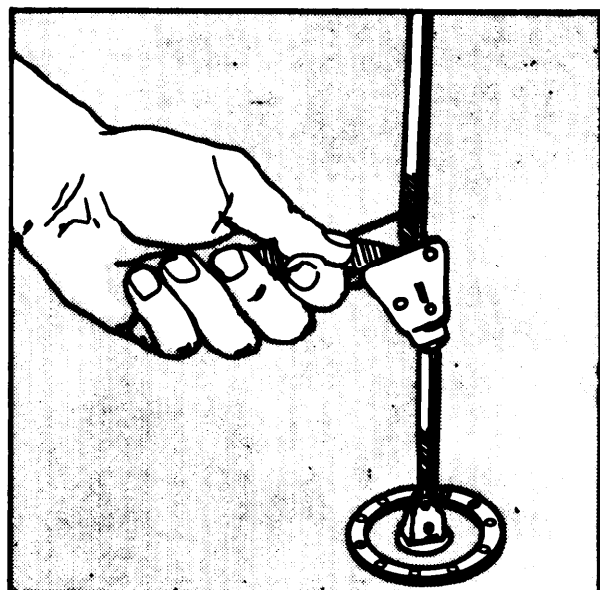
11 Attach the fitting on the bottom of each litter support strap to the proper stud on the cargo floor. Do this by pressing inward on the spring lever, slipping the catch over the stud, and releasing the spring lever.



10 When all four litter handles are in place, reengage the handle clip in the locking bar and lock the bracket by moving the locking handle upward.



12 Tighten the litter support strap by pulling on the free end of the strap until the strap is sufficiently tight.



14856

Figure 6-7. Litter Installation (Sheet 3 of 3)

strap. The brackets are spaced 18 inches apart. A locking device in each bracket secures the litter handles in place. The locking device consists of a handle clip, a slotted locking bar, and a locking handle. The locking handle is hinged to the lower jaw of the bracket. The slotted locking bar is hinged, cam fashion, to the locking handle. The handle clip is hinged to the upper jaw of the bracket and has a hook end which is engaged in one of the slots in the locking bar. When the locking handle is moved down, it forces the locking bar up and releases tension on the handle clip. When the locking handle is moved up, it pulls the locking bar down and forces the handle clip to a positive grip on the litter handle.

**6-19. Litter Poles and Straps.** Twelve litter poles are provided for use in adapting the helicopter for medical evacuation. An attachment fitted to the bottom of each pole has two indentations, on opposing sides, which fit between two studs located in a floor channel. The upper rear side of the pole contains two keyhole slots by which the pole is anchored to studs on the seatback support tubes. A metal spring retainer inside the pole locks under one of the studs when the pole is installed. This prevents accidental dislocation of the pole. The retainer is released for litter pole removal by pulling the grommet which protrudes from the front of the pole. When not in use, the litter poles may be stowed at station 120.

Twelve litter straps are used with the litter poles to support the litters. The straps can be adjusted upward or downward by slide adjusters near the upper and lower ends of the straps. All of the straps are fitted at the top with slipover hooks which are fastened to brackets in the strap stowage recesses. The lower end of each strap has a fitting for attaching the strap to a

tiedown stud on the floor. The straps are stowed in the overhead recesses directly over the floor studs to which the straps will be attached. The stowage recesses are covered with canvas flaps which are zipped along two sides.

**6-20. Litter Loading.** The loading of litters will be accomplished through the lowered aft cargo door and ramp. The forward litter tiers should be loaded first, top to bottom, and then progressively rearward. Litter patients requiring in-flight medical care should be positioned to enable access to injuries requiring attention. If the helicopter is to be loaded with a combination of troops and litter patients, the litter patients should be positioned to the rear of the troops.

**6-21. Combination Seat and Litter Arrangement.**

Combined troop and litter patient loads can be transported by arranging seats and litters as required. Table 6-1 gives the various combinations of seats and litters which can be used.

**6-22. Static Line Anchor Cable.**

A static line anchor cable is provided. The cable is normally stowed in a container (fig. 6-18) located on the right side of the cargo compartment at station 160. When the static line anchor is installed, the cable is attached to the structure between stations 120 and 592. A static line retriever is provided with the static line anchor cable. The retriever is used in conjunction with the winch and is provided to haul-in the static lines at the end of the jumping exercise or to retrieve a hung up paratrooper in an emergency. Refer to Chapter 4 for the procedures on using the static line retriever.

*Table 6-1. Seat and Lifter Arrangement Data*

PERSONNEL		LITTER TIERS		SEATS	
SEATS	LITTERS	(4-MAN)	(1-MAN)	(3-MAN)	
33	0	0	3	10	
27	4	1	3	8	
21	8	2	3	6	
15	12	3	3	5	
9	16	4	3	3	
6	20	5	3	1	
3	24	6	3	0	

## SECTION V MISSION EQUIPMENT

### 6-23. Mission Equipment.

CH-47D mission equipment includes the M-24 armament subsystem, the M-41 armament subsystem, M-130 flare dispenser system, AN/ALQ-156 missile detector system, the cargo handling systems, the cargo hooks and the static line retriever. The cargo handling systems, (except HICHS) the cargo hooks, and the static line retriever are included

in the basic weight of the helicopter or are listed on the chart C for the particular helicopter. Figure 6-8 lists the weight and the moment/1,000 for the M-24 armament subsystem, the M-41 armament subsystem, and the M-130 flare dispenser system. If spare ammunition containers are carried on a particular mission, compute the moment/1,000 for each spare container from the cargo moments chart. Figure

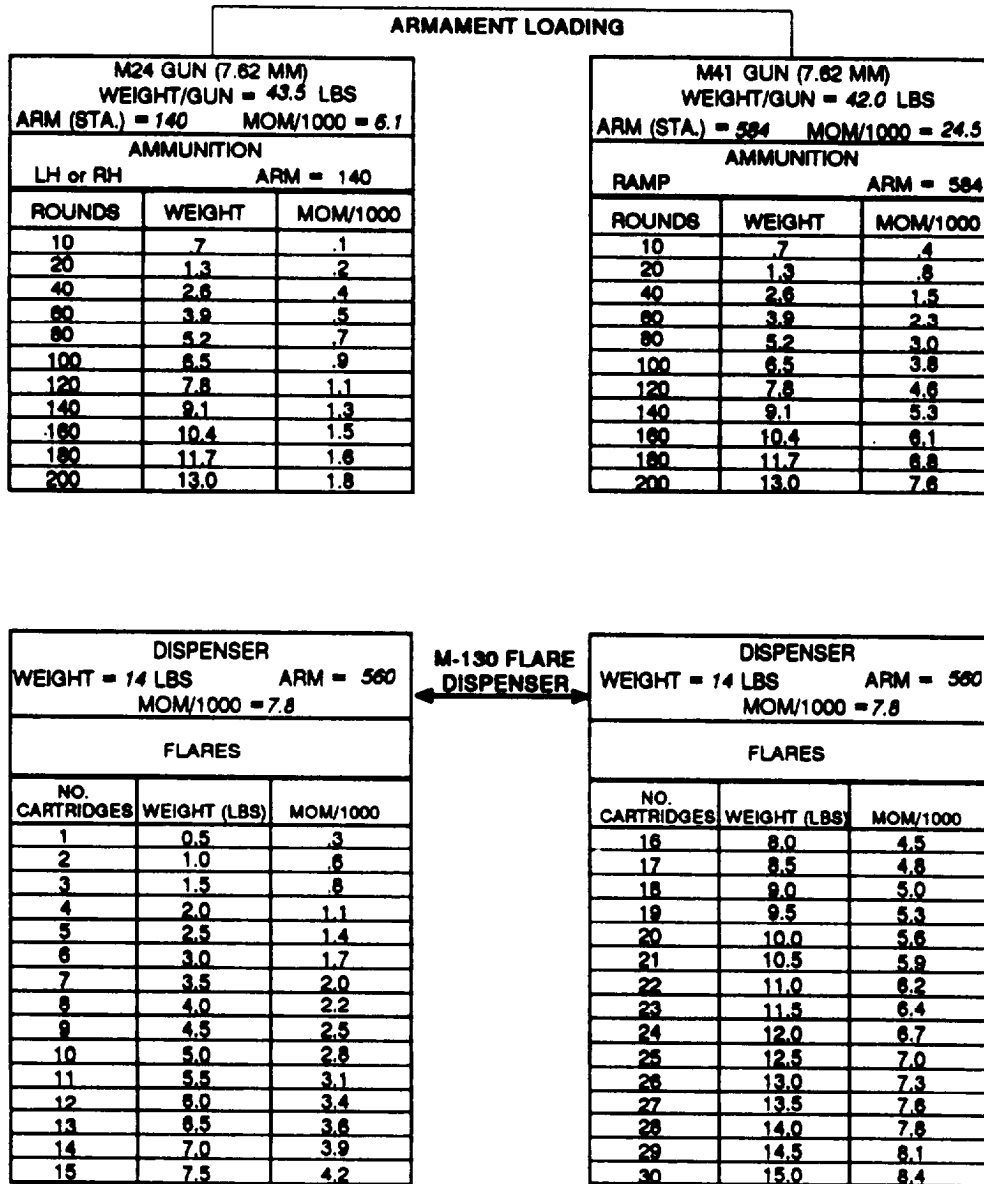


Figure 6-8. Mission Equipment Weights and Moments

6-13 provides the weight and moments charts for internal cargo, figure 6-14 provides the weight and moments

charts for external cargo. HICHS system weight and balance data is provided in table 6-2.

**Table 6-2. Internal Cargo Handling System Weight and Balance**

<b>SECTION</b>	<b>WEIGHT (LB)</b>	<b>ARM</b>	<b>MOM/1000</b>
Cabin Section	647	323	208.981
Ramp Section	141	535	75.435
Ramp Extension	51	554	28.254
Ramp Extension Supports (Stowed)	26	527	13,702
Ramp Support (Stowed)	13	550	7.150
<b>System Totals</b>	<b>878</b>		<b>333.5</b>
<b>System Center Of Gravity</b>	<b>[379.9]</b>		

## SECTION VI CARGO LOADING

### 6-24. General.

This section contains information and instructions for loading and securing cargo in the helicopter. It lists and describes the items of equipment incidental to these operations, instructions for their use, and illustrations where necessary or desirable. It is not the intent of this section to teach principles of cargo loading. It is the purpose of this section to provide detailed information on cargo loading with regard to this helicopter.

### 6-25. Cargo Compartment.

The cargo compartment (fig. 6-9) is 366 inches long, 90 inches wide, and 78 inches high. These dimensions are uniform throughout the cargo compartment, unless the aircraft is configured with HICHS (fig. 6-9). The lower rescue door is opened for rescue operations, aerial loading, and external cargo transport operations. A hydraulically operated door and ramp provide a means for quick and efficient straight-in loading and unloading.

#### NOTE

Figure 6-10 shows the maximum cube size which can be taken into the helicopter through either the main cabin entrance, utility hatch, or cargo loading ramp.

**6-26. Main Cabin Entrance.** The main entrance door is located on the right side of the cargo compartment at the forward end and measures 66 inches in height by 36 inches in width. The door is composed of two sections: the upper section rolls inward and upward to a rest position overhead; the lower section opens outward and downward and serves as a step in the lowered position.

**6-27. Utility Hatch Door.** The utility hatch door is in the center of the cargo compartment floor between stations 320 and 360. The door is hinged along its entire forward edge. It opens upward and forward to expose the lower rescue door and the cargo hook. The door is unlatched by pressing the knob labeled PUSH, and is latched by pressing the unmarked knob.

#### NOTE

When opening or closing the lower rescue door, be certain that the cargo hook is properly stowed and supported by the restraining straps. In addition, close the rescue door, using the actuator only to the point where the latch can engage; the latches will then lift the door and compress the door seal.

**6-28. Lower Rescue Door.** When closed, the lower rescue door forms a part of the fuselage bottom. It is

accessible through the utility hatch door. The lower rescue door is secured by four latches centered around the door perimeter. These latches are connected by linkage to an actuator labeled OPEN and CLOSED. A handcrank, stowed in spring metal clips on the left side of the fuselage, is used to unlatch the door and turn the gears. A drive shaft, which is turned by the gears, moves the door actuator links. The door opens downward and aft underneath the fuselage where it remains during operation.

#### **CAUTION**

**Although tightening of the tiedown straps may be necessary to reduce internal load vibrations, excessive tightening of tiedowns attached to the outboard row of tiedown fittings will limit the effectiveness of the isolated cargo floor.**

**6-29. Cargo Compartment Floor.** The floor is made of extruded panels, riveted together in sections. Raised extruded ridges, running the entire length of the floor, provided surfaces on which cargo is moved. The flooring in the cargo compartment contains sections on either side of the centerline which are strengthened to serve as vehicle treadways. The flooring, from station 200 to 400 and from buttline 44 left to 44 right, rests on rubber vibration isolators which reduce overall internal load vibrations. Tiedown fittings (fig. 6-11) for securing cargo are installed in the floor. There are also studs for attaching troop seats, litter supports, and the base plate for the maintenance crane. The flooring is covered with a walkway compound which provides a non-skid surface for personnel and for vehicles. In construction, the ramp floor is identical with the cargo floor.

#### NOTE

Whenever possible, place all wheeled vehicles entirely on the treadways between stations 200 and 400.

**6-30. Strength Areas.** The weight which the cargo compartment floor (fig. 6-12) can support varies. These variations are largely due to differences in strength of supporting frames and fuselage construction, not because of varying floor strength. To gain the maximum benefit from the cargo compartment floor, the following definitions and weight limitations must be observed.

**6-31. Uniformly Distributed Loads.** Uniformly distributed loads are those loads wherein the total weight of the item is equally spread over the item's entire contact area. Contact area is large compared to size and weight of the load.

**6-32. Uniformly Distributed Load Limits.** Compartments C, D, and E (fig. 6-12) are limited to **300** psf. The

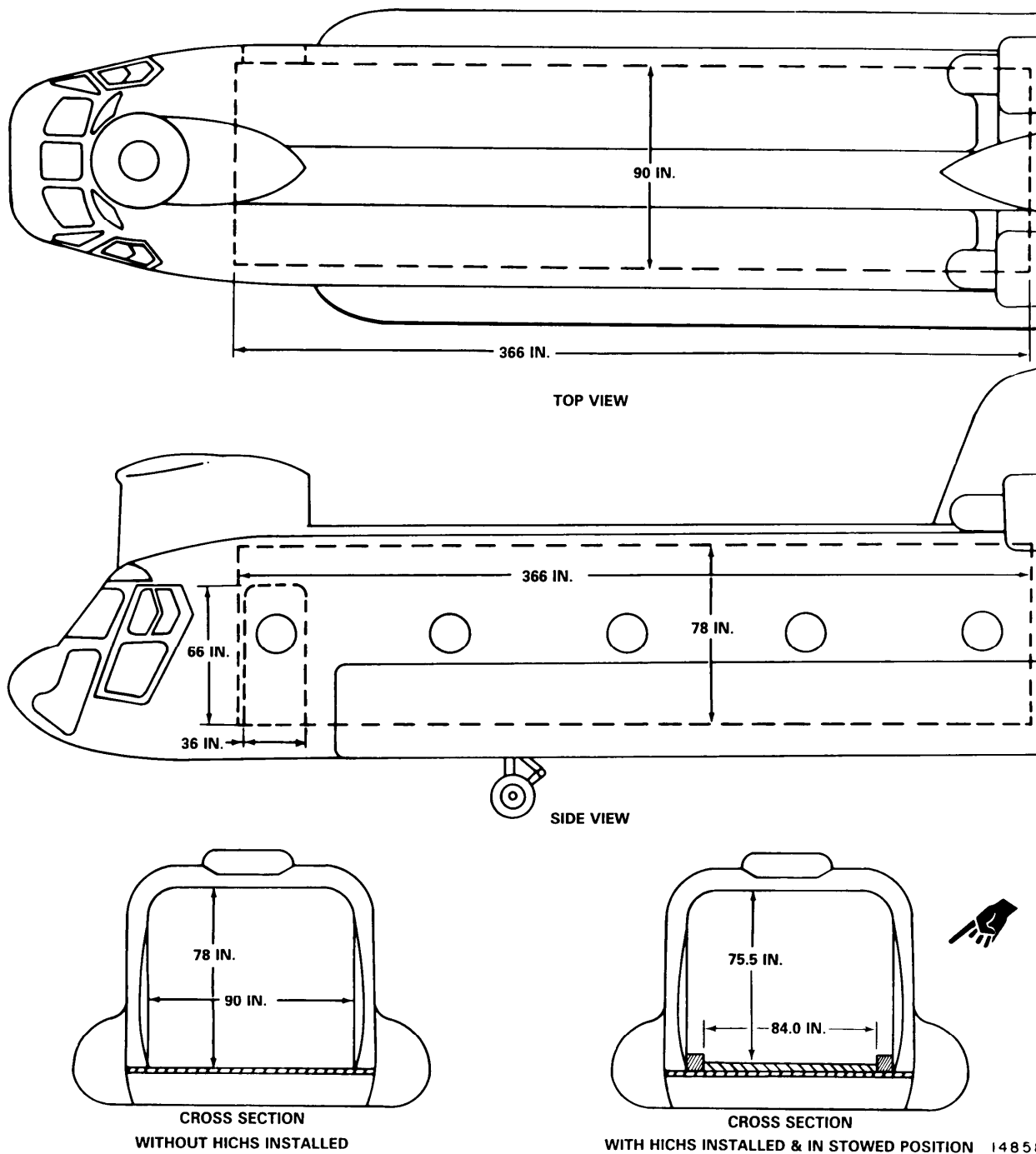
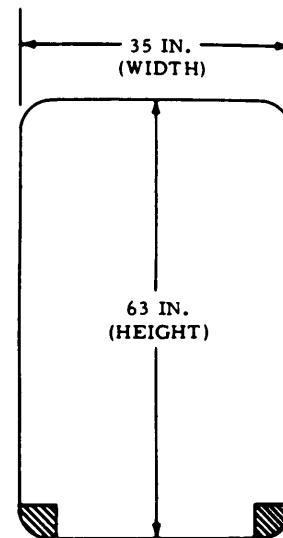


Figure 6-9. Cargo Compartment Dimensions



MAXIMUM PACKAGE SIZE TABLE FORWARD DOOR--RIGHT SIDE										
WIDTH (Inches)	HEIGHT--INCHES									
	53 & Under	54	55	56	57	58	59	60	61	62
	MAXIMUM LENGTH--INCHES									
12	249	246	242	238	234	223	170	170	170	165
13	233	230	227	224	221	211	162	162	162	157
14	217	215	213	210	208	199	154	154	154	150
15	205	204	203	199	197	187	147	147	147	144
16	195	194	193	189	187	176	141	141	141	138
17	186	185	183	180	178	166	136	136	136	133
18	177	176	174	172	170	157	131	131	131	128
19	169	168	166	164	162	149	126	126	126	124
20	161	160	159	157	155	142	122	122	122	120
21	155	154	153	151	148	135	118	118	118	116
22	149	148	147	145	141	129	114	114	114	112
23	143	143	142	140	135	124	111	111	111	109
24	138	138	137	135	129	119	108	108	108	106
25	133	133	132	130	124	114	105	105	105	103
26	128	128	127	125	119	110	103	103	103	101
27	125	124	123	121	115	106	101	101	101	99



**NOTE:**  
Shaded part shows approximate area obstructed due to door opening linkage.

Figure 6-10. Maximum Package Size (Sheet 1 of 3)

14859

cargo loading ramp (fig. 6-12) is limited to 300 psf with a maximum total load of 3,000 pounds when the ramp is level with the cargo floor.

**6-33. Concentrated Loads.** Concentrated loads are those loads wherein the total weight of the item is supported by a contact area that is small compared to the size and weight of the load.

**6-34. Concentrated Load Limits.** Concentrated loads can be loaded on the treadways and on the walkway. The treadways aft of station 160 and ramp extensions are stressed for a total wheel load of 2,500 pounds. The treadways forward of station 160 and the walkway can be loaded to a total wheel load of 1,000 pounds. Concentrated loads are not to exceed 75 psi for pneumatic tires or 50 psi for block or roller-type wheels.

**NOTE**

The above floor loading limitations apply to the static weight of the item prior to applying any restraint devices.

**NOTE**

The minimum distance, in feet, between the centers of any two adjacent concentrated loads is determined by totaling the adjacent loads and dividing by 1,000.

**6-35. Load Limits.**

Vehicles exceeding the limitations may be loaded with the use of shoring, provided that the vehicle weights remain within the operating weight limits of the helicopter. In cases where the wheels of a vehicle cannot rest on both treadways because of a narrow wheel tread, shoring must be used to spread the load over the treadways. General cargo must not exceed floor pressure of 300 psf. An easy way to determine floor pressure of various loads is to divide the weight of the load by the contact area (in square inches or square feet).

**NOTE**

Load on pallets supported by the longitudinal beams or skids resting on the floor can result in concentrated loads at points where the beam/skid rests on or crosses floor formers. The concentrated load can be determined by dividing the weight of the item by the number of floor former/skid intersection points or by the number of locations where the skid rests on the floor formers. The floor limits are the same as the concentrated load limits in the treadway and center section of the floor, that is 2,500 pounds and 1,000 pounds.

**6-36. Compartment Identification.**

The cargo compartment is divided, for weight and balance purposes, into three compartments designated

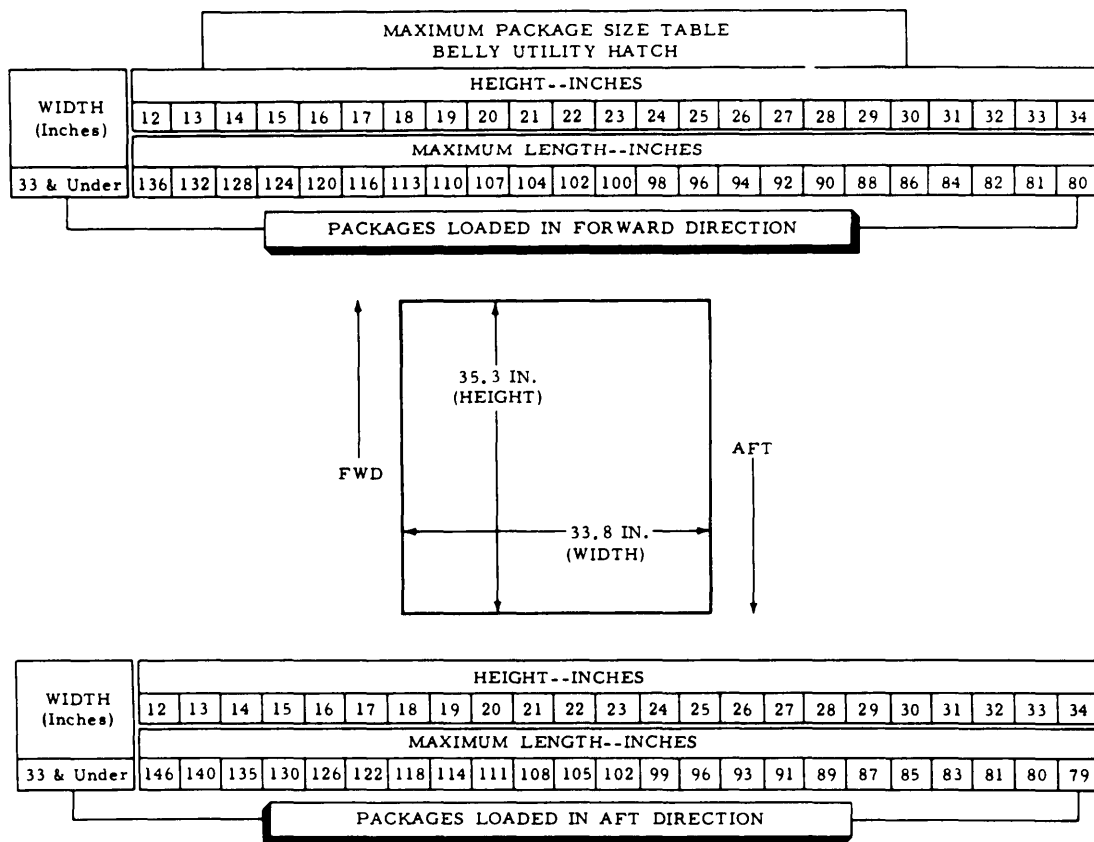


Figure 6-10. Maximum Package Size (Sheet 2 of 3)

14860

C, D, and E, running fore and aft. (fig. 6-1). When the cargo ramp is used as an extension of the cargo compartment, it is designated as F for weight and balance purposes. These compartment designations and their limiting fuselage stations are stenciled on the cargo compartment walls.

**6-37. Compartment Capacities.**

Based on a maximum distributed floor loading of 300 psf, the compartment capacities can be obtained by multiplying the floor loading by the floor area of the individual compartment; however, this weight may exceed present limitations. Figure 6-12 lists the maximum capacity of each compartment. In addition to the limitations in figure 6-12, compartment loads will be limited by those limitations set forth in Chapter 5.

**6-38. Tiedown Fittings.**

Tiedown fittings (fig. 6-11) for securing cargo are installed on the cargo compartment floor and on the ramp floor. All the fittings are D-ring types. There are 87 5,000-pound-capacity tiedown rings (83 in the fuselage floor and 4 in the ramp floor) and eight 10,000-pound-capacity tiedown fittings. The fittings are normally used with tiedown devices which will not exceed the limits of the fitting.

**6-39. Five Thousand-Pound-Capacity Tiedown Fittings.** The 83 5,000-pound-capacity tiedown fittings in the cargo compartment floor are equally spaced in five rows spaced 20 inches apart longitudinally. The four

in the ramp are in a rectangular pattern. Each 5,000-pound-capacity fitting swivels freely and is capable of resisting a single maximum load of 5,000 pounds exerted along any radius of a hemisphere, the flat side of which is the surface of the floor. The fittings are hinged so that they can be seated in floor recesses when not in use.

**WARNING**

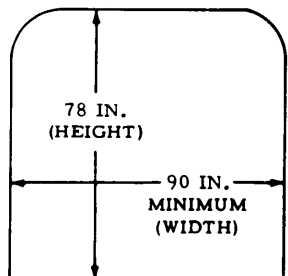
**The 10,000-pound-capacity tiedown fittings must be screwed into the threaded receptacles to full depth to achieve their rated capacity.**

**6-40. Ten Thousand-Pound-Capacity Tiedown Fittings.** There are eight 10,000-pound-capacity tiedown fittings on the cargo compartment floor. Four fittings are interposed along both outboard rows of 5,000-pound-capacity fittings, spaced at intervals of 80 inches from station 240 to station 480. These fittings are not always used and they might be in the way when installed. Therefore install only when necessary. When they are to be used, the fittings are screwed into threaded receptacles at the fitting locations. When the fittings are not being used, threaded plugs are screwed into the receptacles to protect the thread in the receptacles.

**6-41. Cargo Loading Aids.**

The helicopter has a number of features to facilitate loading of cargo. Some of these features are parts of

		MAXIMUM PACKAGE SIZE TABLE RAMP DOOR															
		HEIGHT - INCHES															
WIDTH (INCHES)	62 & Under 63 64 65 66 67 68 69 70 71 72 73 74 75 76 77																
	MAXIMUM LENGTH-- INCHES																
62 & Under	362	362	362	362	362	362	362	362	330	282	230	180	135	100	67	30	
63	362	362	362	362	362	362	362	362	328	280	228	178	133	98	66		
64	362	362	362	362	362	362	362	362	326	278	226	176	130	96	64		
65	362	362	362	362	362	362	362	362	322	274	222	173	127	93			
66	362	362	362	362	362	362	362	362	318	270	218	169	123	90			
67	362	362	362	362	362	362	362	362	313	266	214	165	119	86			
68	362	362	362	362	362	362	362	357	307	260	208	160	114	81			
69	362	362	362	362	362	362	362	348	299	252	201	154	107	75			
70	362	362	362	362	362	362	362	339	290	243	193	146	99				
71	362	362	362	362	362	362	362	330	281	234	185	139	91				
72	362	362	362	362	362	362	362	321	272	226	177	131	83				
73	362	362	362	362	362	362	352	312	263	216	167	122	75				
74	362	362	362	362	362	362	339	298	250	203	156	112					
75	362	362	362	362	362	362	325	284	237	190	144	101					
76	362	362	362	362	362	348	311	270	223	177	132	90					
77	362	362	362	362	362	334	297	256	209	164	119						
78	362	362	362	362	346	316	278	237	191	147	104						
79	362	362	362	362	329	298	258	218	173	129	85						
80	362	362	362	362	310	276	236	195	151	108							
81	362	362	362	362	289	253	213	172	128	85							
82	362	362	362	362	267	230	188	148	105								
83	362	362	362	362	241	202	161	121									
84	362	362	362	362	213	174	133	93									
85	362	362	362	362	182	142	100										
86	362	362	362	362	146	105											
87	362	362	362	362	105												
88	362	362	362	362													
89	362	362	362	362													
90	362																



14861

Figure 6-10. Maximum Package Size (Sheet 3 of 3)

systems and are permanently installed; others are equipment which is stowed in the helicopter. The following paragraphs contain descriptions of items classed as loading aids. Specific instructions for some of these items may be found in other parts of this manual and are referenced.

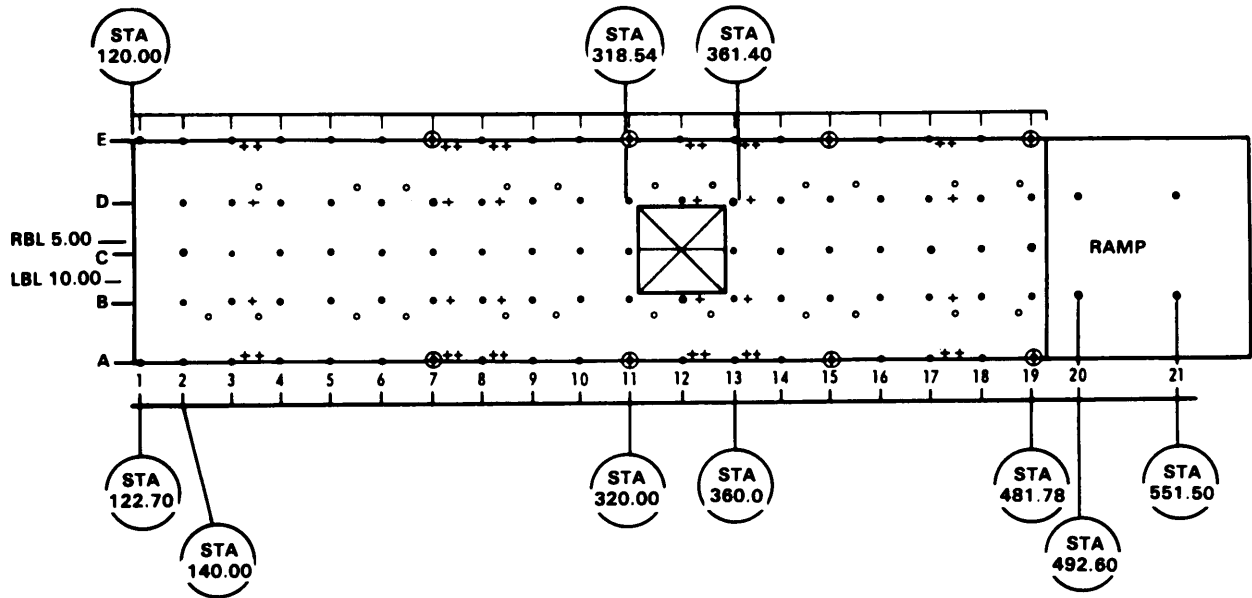
**6-42. Cargo Loading Ramp.**

The ramp provides a means of quickly loading and unloading troops and cargo. It can also be used to support portions of a cargo load which exceeds the longitudinal dimensions of the cargo floor. When used for additional cargo space, the ramp must be positioned so that the ramp floor is level with the cargo floor. In

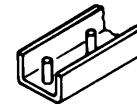
this situation, the weight of the cargo item resting on the ramp must not exceed 3,000 pounds or 300 psf.

**6-43. Auxiliary Loading Ramps.**

Three auxiliary loading ramps are hinged to the aft end of the ramp (fig. 6-15). When the lamp is lowered, these auxiliary ramps are unfolded to provide flush contact between the ramp and the ground. The auxiliary loading ramps can be positioned to accommodate various vehicle tread widths or butted together to facilitate winching of bulk cargo. When not in use, the auxiliary ramps are stowed in an inverted position on the floor of the ramp or removed. One of the auxiliary loading ramps when attached to the ramp can also be used as a work platform. A collapsible support attached to the ramp



- SEAT FITTING
- + LITTER FITTING
- 5,000-LB TIEDOWN FITTING
- ⊕ 10,000-LB TIEDOWN FITTING



5,000-LB TIEDOWN FITTING

LITTER FITTING

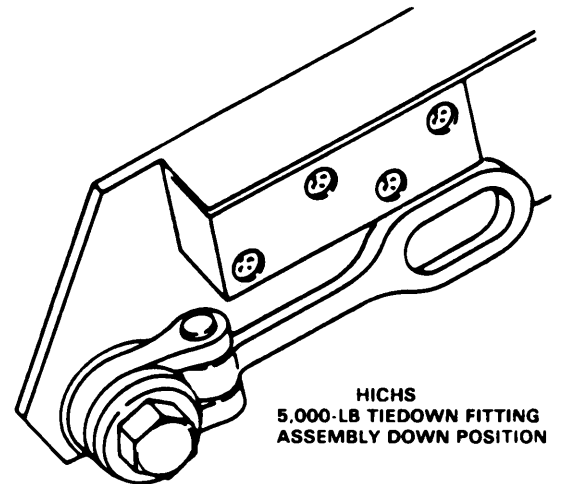
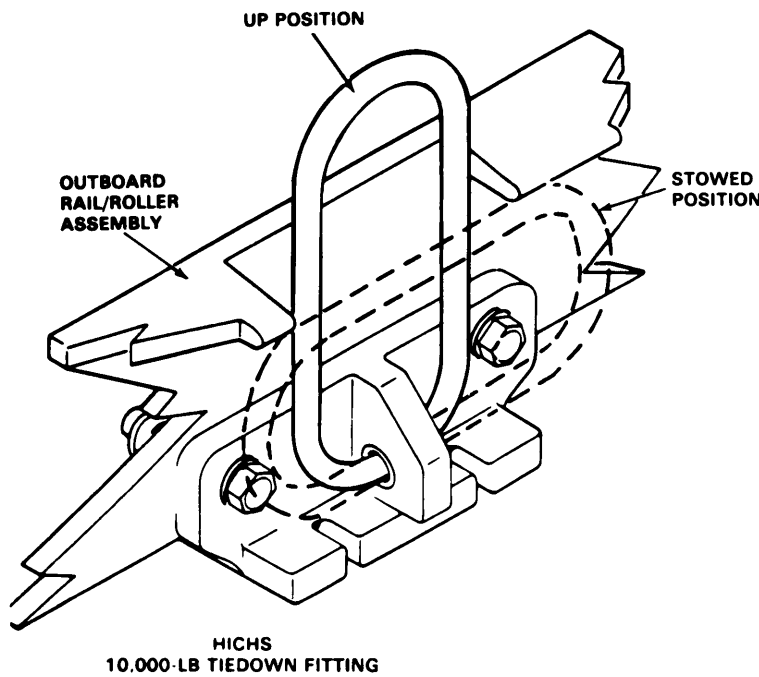


Figure 6-11. Tiedown Fittings

COMPARTMENT DATA							
COMPARTMENT DESIGNATION	PILOTS (A)	EQUIP (B)	CARGO			RAMP (F)	TAIL (G)
			(C)	(D)	(E)		
CENTROID Inches from Ref Datum	75	108	181	303	425	*536	607
FORWARD LIMIT Inches from Ref Datum	21.5	95	120	242	364	486	584
AFT LIMIT Inches from Ref Datum	95	120	242	364	486	584	630.5
MAXIMUM CAPACITY Pounds			** 22875	** 22875	** 22875	3000	
FLOOR AREA Square Feet			76.3	76.3	76.3	*61.8	
VOLUME Cubic Feet			491.3	491.3	491.3	*373.8	
MAXIMUM CAPACITY Pounds per Square Foot			300	300	300	300	
TREADWAY Max uniformly distributed load over limited area of 1 square foot or max load per wheel.			2500	2500	2500	2500	
CENTER SECTION Between treadway-max uniformly distributed load over limited area of 1 square foot or max load per wheel.			1000	1000	1000	1000	

NOTES:

1. RAMP (F) \* based upon ramp open, level with floor plane.
2. Centroids for Compartments C, D, E, & F are based upon floor area.
3. All volumes based upon projection of floor area to ceiling.
4. \*\*Do not exceed Gross Weight Limitations
5. In order to keep the emergency exits clear, it is recommended that cargo not be loaded forward of station 160.

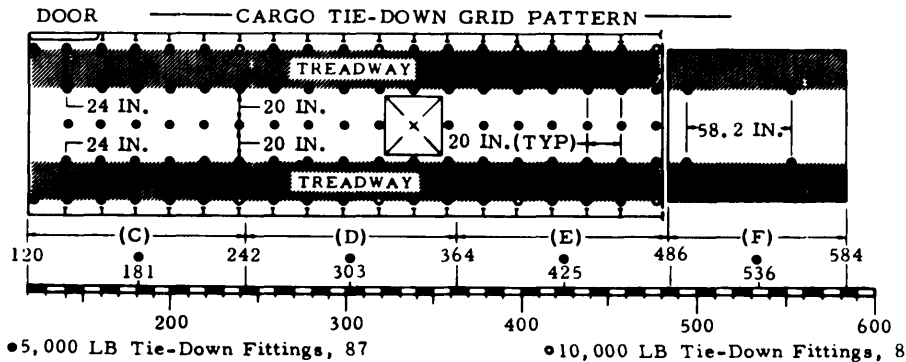


Figure 6-12. Compartment Data

# CARGO MOMENT

## EXAMPLE

**WANTED**  
CARGO MOMENT

**KNOWN**  
CARGO WEIGHT=15240 LB.  
CARGO LOCATION=STA 210

**METHOD**  
ENTER WEIGHT OF EACH  
ITEM OF CARGO HERE.  
MOVE RIGHT TO  
CARGO LOCATION.  
MOVE DOWN. READ  
MOMENT=3200

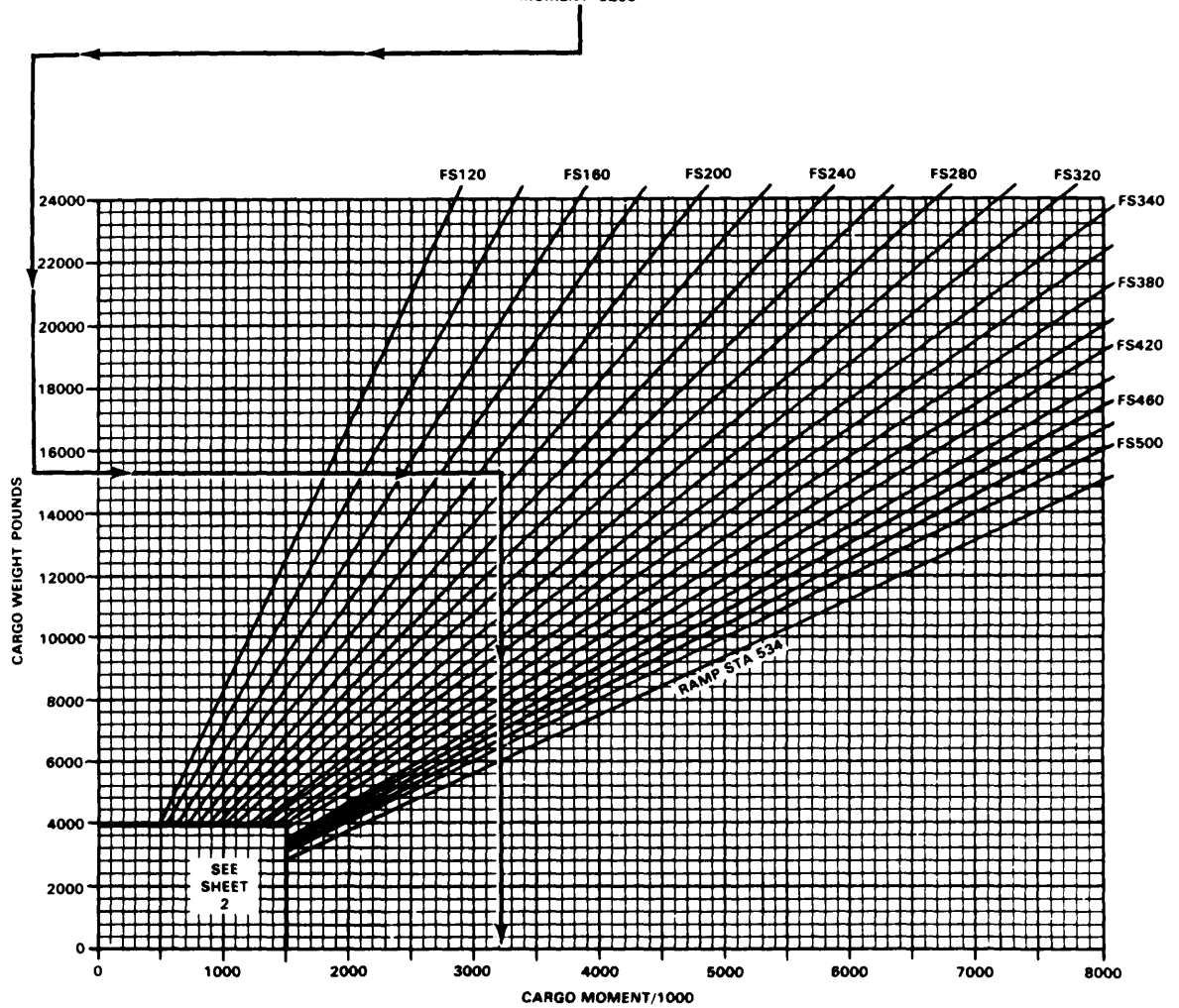


Figure 6-13. Internal Cargo Moments Chart (Sheet 1 of 2)

# CARGO MOMENT

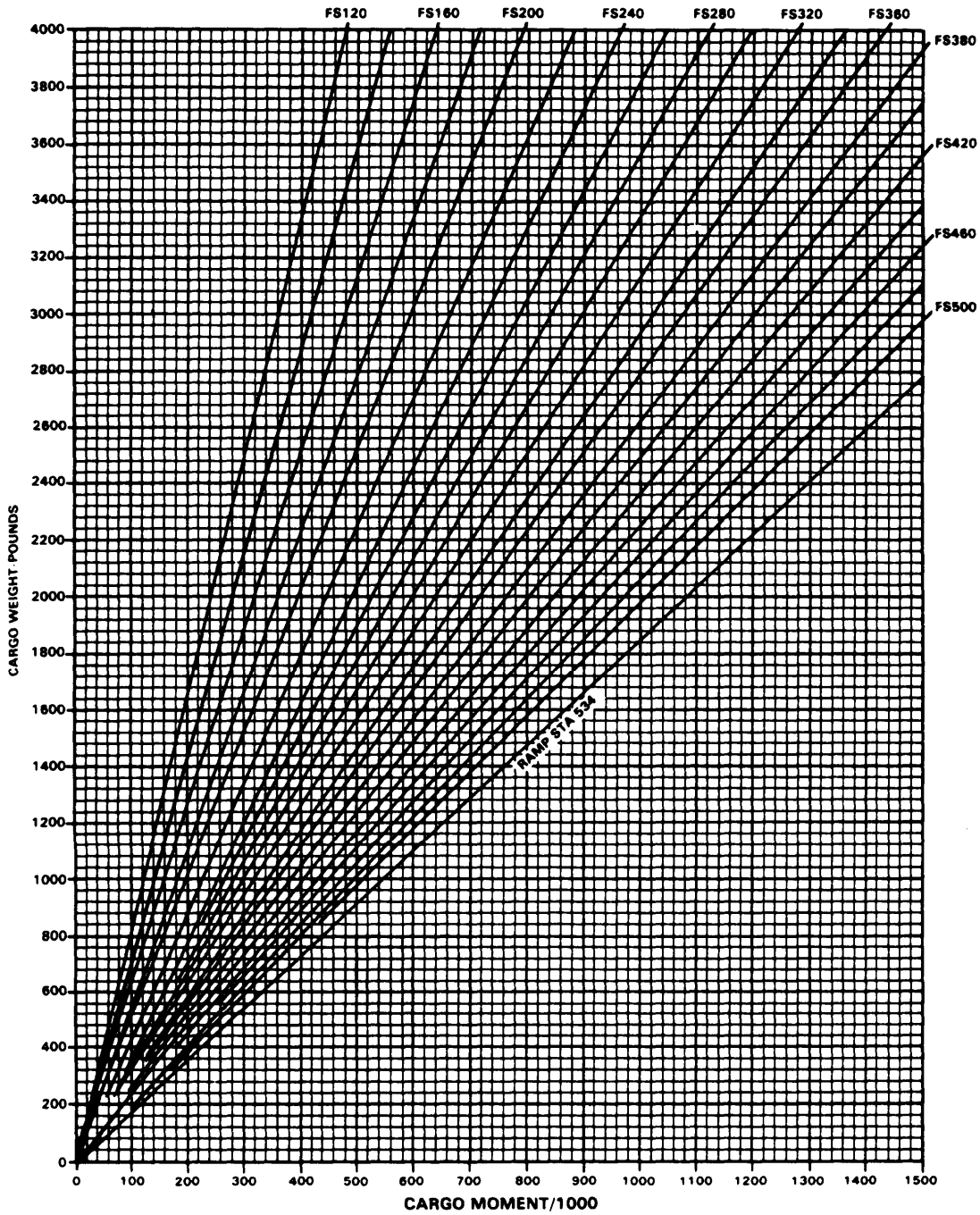
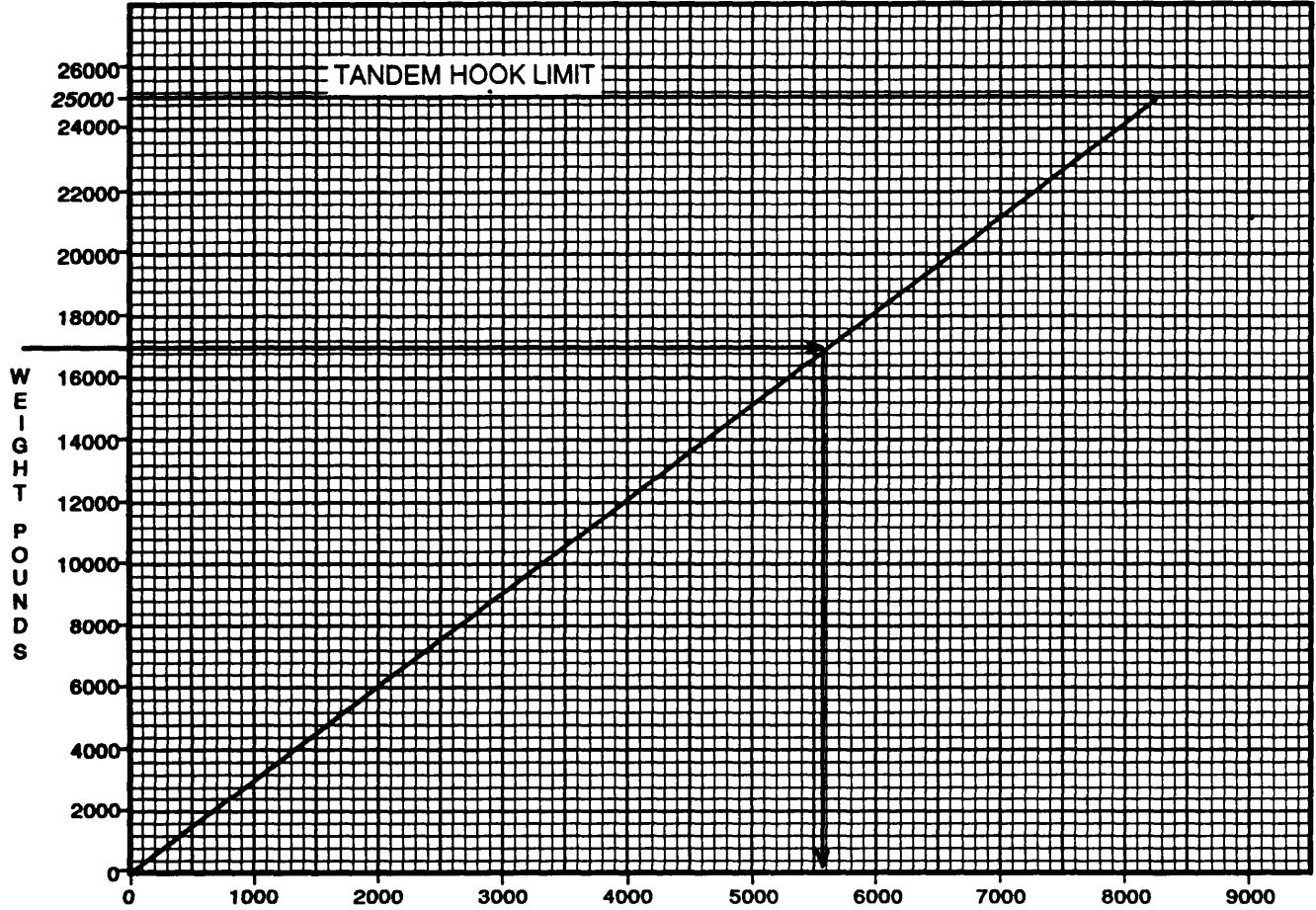


Figure 6-13. Internal Cargo Moments Chart (Sheet 2 of 2)

TANDEM HOOKS (ARM = 329.0)

**WARNING**  
OBSERVE CENTER OF GRAVITY LIMITS



**EXAMPLE:**

**WANTED :** CARGO MOMENT OF  
LOAD ON FORWARD AND AFT  
HOOKS.

**KNOWN :** CARGO WEIGHT = 17,000 LBS

**METHOD :** ENTER AT CARGO WEIGHT.  
MOVE RIGHT TO LINE. MOVE DOWN TO  
READ MOMENT/1000 = 5593

Figure 6-14. External Cargo Moments Chart (Sheet 1 of 2)



CARGO HOOK MOMENTS

**WARNING**  
OBSERVE CENTER OF GRAVITY LIMITS

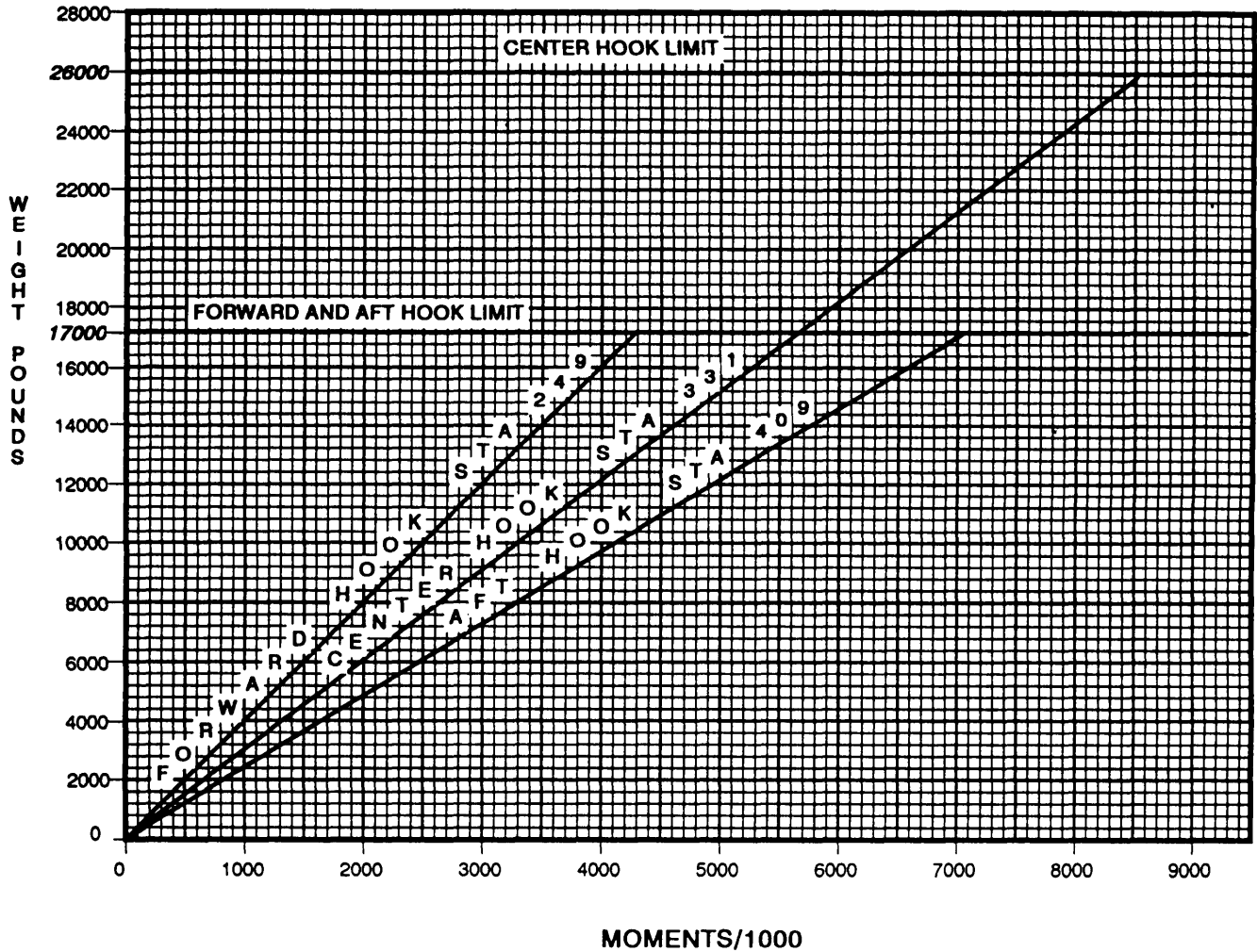


Figure 6-14. External Cargo Moments Chart (Sheet 2 of 2)

bottom allows the ramp to be positioned at any convenient height when used as a work platform.

**6-44. Winch.**

Refer to Chapter 4, Section III.

**6-45. Cargo Door and Ramp.**

The cargo door and ramp has an upper section, or cargo door, and a lower section, or ramp. The door retracts into the ramp when the ramp is being lowered and extends when the ramp is being raised. Retraction or extension of the door can be isolated through the ramp sequence valve so the ramp can be raised or lowered with the door retracted into the ramp or extended. The door is an integral part of the ramp and only provides closure; therefore, references made to the ramp will be understood to include the door and its related movements. The cargo door is jettisonable to provide an emergency exit. The cargo door and ramp is located at the aft end of the cargo compartment and is used for troop and cargo loading and unloading. In closed position, it conforms to the side contours of the fuselage (fig. 6-15). Internal locks in the ramp actuating cylinders prevent accidental opening and constitute the only locking mechanism for keeping the ramp closed. The ramp is hinged to the fuselage and opens rearward and downward to rest on the ground. When

lowered to ground rest, the ramp inclines downward approximately 6.75° and maintains a uniform 78-inch overhead clearance, (if HICHS is not installed), of the cargo compartment. A continuous hinge runs the entire width of the aft upper edge of the ramp and holds the three auxiliary loading ramps. The auxiliary ramps unfold to bridge the gap between the ramp and the ground for vehicle loading and unloading. They can be adjusted laterally to accommodate various vehicle tread widths. Hydraulic power to operate the ramp is supplied through the utility hydraulic system.

**6-46. RAMP CONTROL Valve.** Lowering and raising the ramp is controlled by a RAMP CONTROL valve on the right side of the aft cargo compartment between the floor and the overhead at sta 490 (fig. 6-16). The RAMP CONTROL valve is operated either electrically or manually. Electrical operation is performed by setting the RAMP PWR Switch to EMERG, and using the RAMP EMER control switch on the cockpit overhead HYD control panel (Chapter 2, Section VI). Manual operation is accomplished by setting the RAMP PWR switch to ON, and using a three-position lever mounted on the RAMP CONTROL valve. The lever positions are labeled UP, STOP, and DN (down). The control lever can be reached from the outside through a hinged panel on the aft fuselage.

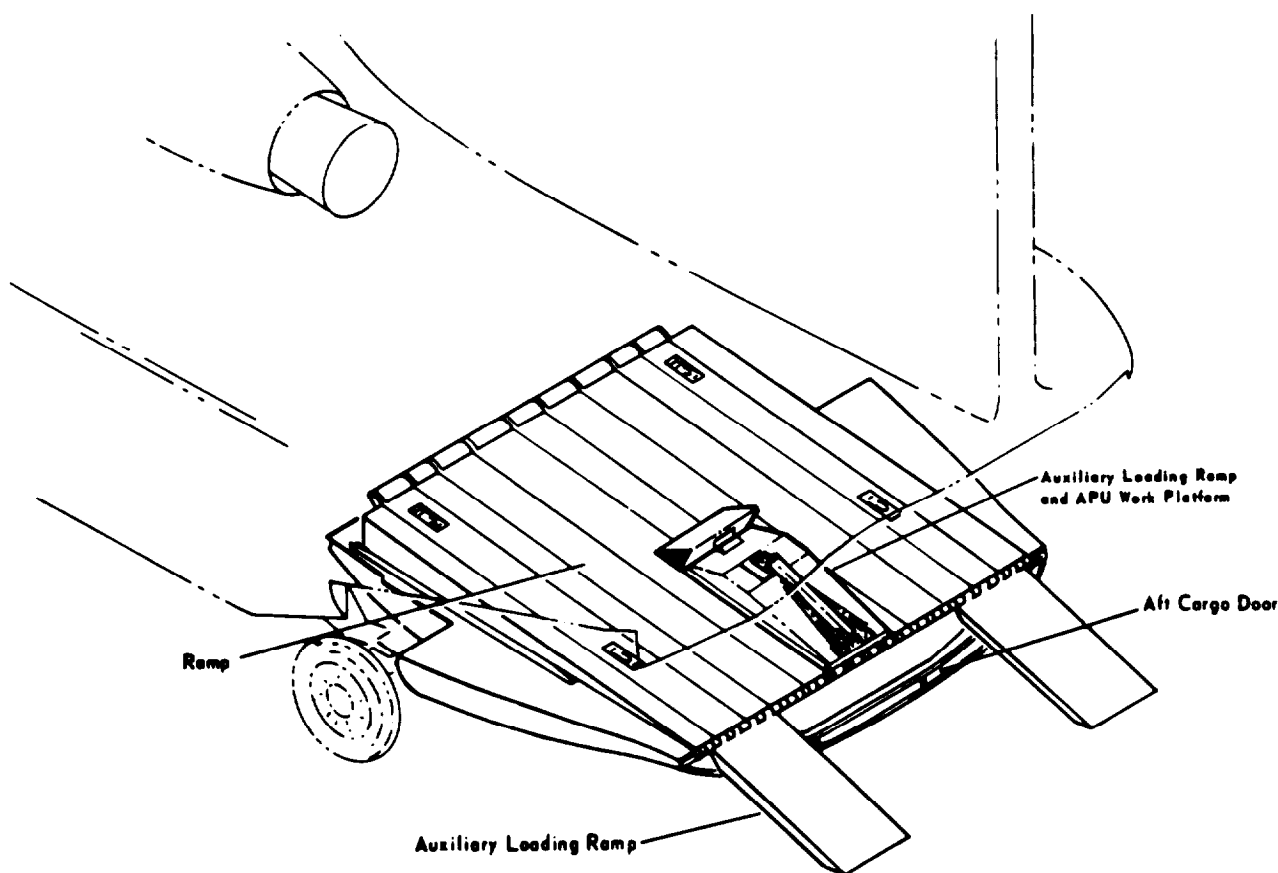
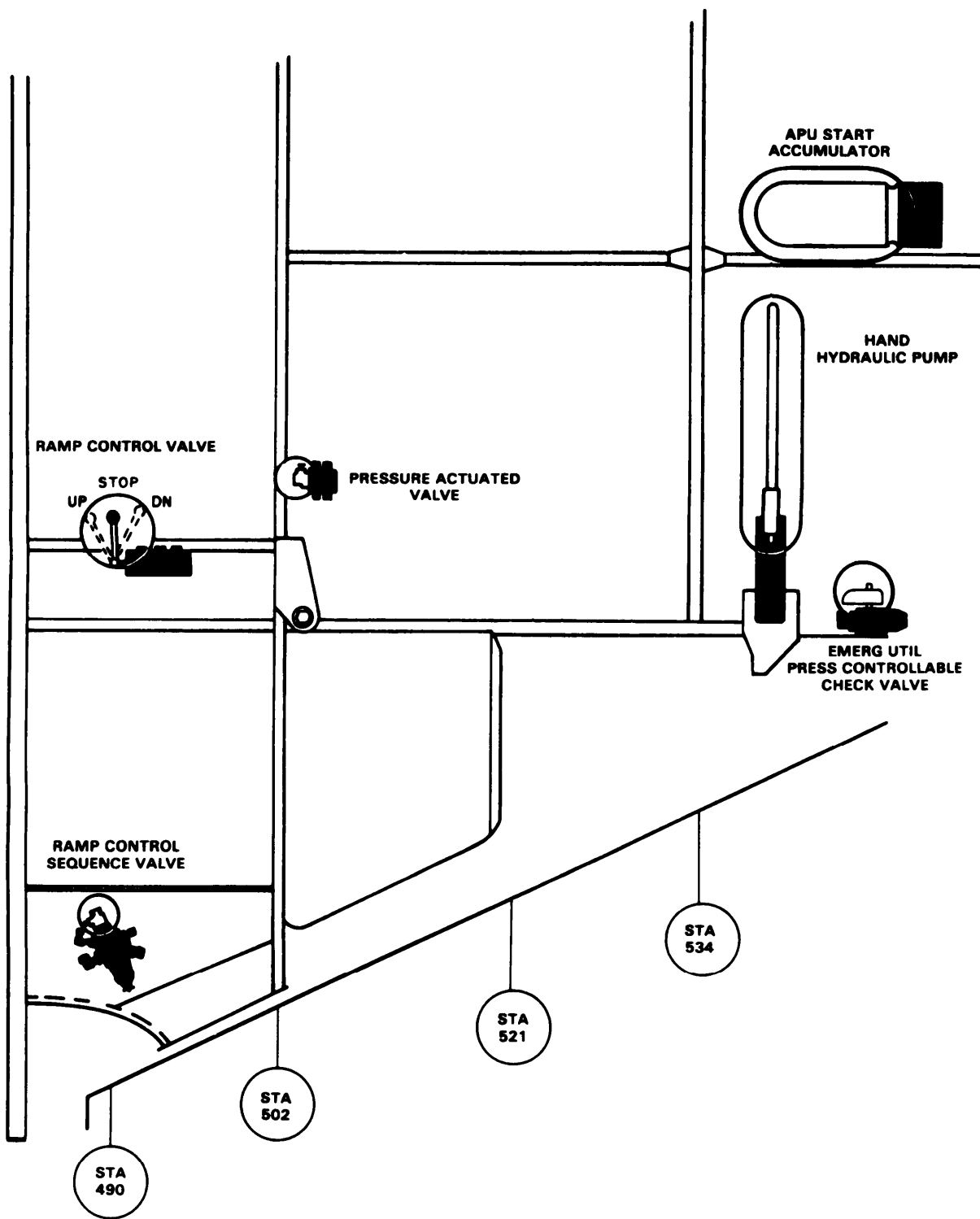


Figure 6-15. Cargo Door and Ramp

D145-176-10



22926

Figure 6-16. Ramp Controls

**CAUTION**

**Do not press the sequence valve plunger unless the ramp is down.**

**6-47. Ramp Control Sequence Valve.** A mechanically operated sequence valve controls the sequence of cargo door and ramp operation (fig. 6-17). The valve is below the ramp control valve at the ramp hinge line. A plunger on top of the valve is manually pressed to hold the cargo door at full open during ramp operation. The plunger can be locked in the depressed position by rotating a retainer pin which extends from the side of the valve.

**6-46. Pressure Actuated Valve.** Ramp operation is stopped during cargo door operation by a hydraulic pressure actuated valve. The valve is located near the ramp control valve (fig. 6-16). A plunger provides manual override of the valve if it sticks.

**6-49. Accumulator Gage.** A gage at station 534, right side, indicates APU accumulator pressure in psi (fig. 6-16). A pressure reading on the accumulator gage in excess of 2,500 psi is sufficient for operating the ramp.

**6-50. Equipment Loading and Unloading.**

The following procedures should be observed in preparing the helicopter for a cargo transport mission:

- a. Doors - Open.
- b. Parking brake - On.
- c. Troop seats - Stow.
- d. Cargo compartment - Clean.
- e. Tiedown devices - Check, for type and quantity.

- f. 10,000 lb tiedown fittings - Install as required.
- g. Loading aids - Check, for condition and operation.
- h. Weight and balance data - Check.
- i. Emergency equipment - Check.
- j. Emergency exits - Inspect.
- k. Cargo load - Inspect.

**6-51. Ramp Operation.**

**6-52. Normal Operation.**

**WARNING**

**When the RAMP PWR switch is OFF, be sure the RAMP CONTROL VALVE remains at STOP. If the RAMPCONTROL VALVE is moved to UP or DN, the ramp may free fall.**

1. Lower the ramp as follows:
  - a. RAMP PWR switch - ON.

**NOTE**

Perform step b. and c. only if the ramp is lowered with accumulator pressure.

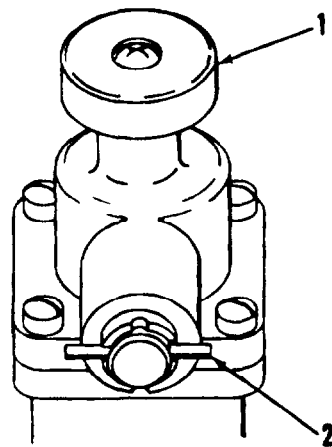
- b. APU accumulator gage-Check 2,500 psi or more. If the pressure reading is below 2,500 psi, operate the hand pump to build up pressure.
- c. EMERG UTIL PRESS valve - Open.

**TO RENDER THE DOOR SECTION OF THE RAMP INOPERABLE IN THE RETRACTED POSITION:**

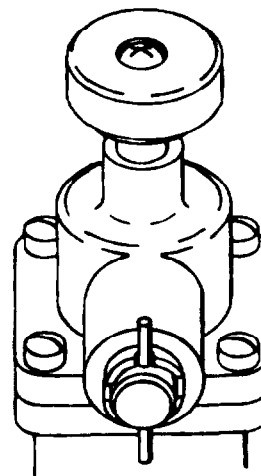
1. LOWER RAMP AND RETRACT DOOR.
2. DEPRESS THE PLUNGER.
3. ROTATE THE RETAINER PIN.

**WITH THE RETAINER PIN IN THIS POSITION THE DOOR SECTION OF THE RAMP WILL OPERATE NORMALLY.**

**LEGEND**  
 1 - PLUNGER  
 2 - RETAINER PIN



**DOOR SECTION INOPERABLE**



**DOOR SECTION OPERABLE**

*Figure 6-17. Sequence Valve Operation*

- d. Ramp control valve lever - DN, allowing ramp to lower to a position of ground rest, then STOP. If the ramp is to be adjusted to a level other than ground rest, or fully closed, with the cargo door in the retracted position, perform the following:
  - (1) Sequence valve plunger - Press and hold.
  - (2) Sequence valve plunger retainer pin - Rotate to the horizontal position to lock the plunger in.
- 2. Raise the ramp as follows:
  - a. Sequence valve plunger-Check, released if ramp and cargo door are to be closed.

**NOTE**

Perform step b. only if accumulator pressure is used to raise the ramp.

- b. EMERG UTIL PRESS valve - Open.
- c. Ramp control valve lever - UP, allowing ramp to close. If accumulator pressure is not sufficient to raise the ramp, operate the hand pump.
- d. Ramp control valve lever - STOP.

**CAUTION**

**The ramp must be at or above floor level during takeoffs and landings.**

**6-53. In-Flight Operation.**

The ramp can be operated at airspeeds up to Vne. At speeds up to 60 knots, the ramp will open normally. At speeds above 60 knots, air pressure from within the cargo compartment is required. To get this pressure, the vent blower can be turned on or the upper section of the cabin door can be opened.

**CAUTION**

**Do not attempt to manually operate the cargo door when the utility hydraulic system is pressurized. Motor damage can result.**

**6-53.1. Ramp Emergency Control.**

**WARNING**

**The RAMP EMER control switch is intended for emergency use only during smoke and fume elimination procedures. Inadvertent operation of the cargo ramp and cargo door from the cockpit may result in injury to personnel or damage to equipment.**

- 1. Open the ramp as follows:
  - a. RAMP PWR switch - EMERG.

**NOTE**

Momentary selection of the RAMP EMER control switch to the DN position will result in approximately 5 seconds of the ramp and cargo door opening operation sequence. The opening sequence of the ramp can be halted during the 5 second cycle by momentarily placing the RAMP EMER control switch to the UP position. Continuous lowering of the ramp (longer than 5 seconds) can be achieved by holding the RAMP EMER switch in the DN position until the desired ramp position is attained.

- b. RAMP EMER control switch - DN momentarily, then back to HOLD. The ramp downward cycle can be halted by momentarily setting the RAMP EMER control switch to UP.
- c. Repeat step b. if necessary, until desired ramp position is achieved, or hold the switch in the DN position until the ramp reaches the desired position.

2. Close the ramp as follows:

- a. RAMP PWR switch.- EMERG.
- b. RAMP EMER control switch - UP until door is closed, then back to HOLD.

**6-54. Manual Operation - Cargo Door.**

Should the need arise to retract or extend the cargo door section of the ramp manually, insert the handcrank as shown in figure 6-19. Crank clockwise to retract. Crank counter-clockwise to extend.

**6-55. Preparation of General Cargo.**

Before loading cargo, it is advisable to inspect items of cargo with regard to dimensions, weight, contact pressure, center of gravity, and hazards. This data will be helpful in determining the placement of the load in the helicopter and in computing weight and balance. Refer to FM 55-450-2.

**6-56. Cargo Dimensions.** Any item of cargo which appears to have critical dimensions for loading into the helicopter should be measured and checked against door and compartment dimension limitations.

**6-57. Cargo Weight.** Package weight of individual items of cargo should be legibly stenciled on an exterior surface. If not provided, the weight must be determined in order to plan cargo placement, to calculate contact pressure, and to compute helicopter weight and balance. The same rule applies to palletized cargo and vehicle loads.

**6-58. Cargo Center of Gravity.** The center of gravity (C.G.) of each item of cargo must be determined in order to compute weight and balance by the station method. As a rule, those items of cargo crated for transport will be marked with a C.G. If the C.G. is not

marked, it can be determined by methods provided in FM 55-450-2.

#### **6-59. Vehicle Load.**

The same general rules that are observed in cargo loading apply to vehicle loading. In addition, fuel tank caps, radiator caps, and battery filler caps should be checked and secured. Fuel tanks should be checked to see that they are not filled above three-quarters capacity. Air trapped in a fuel tank will expand at altitude and force fuel out through the filler neck, creating a fire hazard. If fuel tanks are filled to capacity, some fuel must be drained off before the vehicle is loaded. Also, check tire pressures and, if necessary, deflate tires to prescribed limits.

#### **6-60. Hazardous Cargo.**

Items of cargo possessing dangerous physical properties, such as explosives, acids, flammables, etc., must be handled with extreme caution and in accordance with established regulations and TM 38-250.

#### **6-61. General Instructions for Loading, Securing, and Unloading Cargo.**

There are three prime factors to be considered in properly loading the helicopter. These factors are weight, balance, and restraint. The weight of the cargo to be loaded must remain within safe operating limits, and the cargo must be restrained from shifting during takeoff, flight, and landing. Refer to FM 55-450-2 to determine or compute loading, shoring and restraint criteria.

#### **6-62. Weight and Balance.**

Refer to TM 55-1500-342-23 and figure 6-25 to compute helicopter GW/CG and complete Form F.

#### **6-63. Restraint.**

Items of cargo within the helicopter are subject to the same forces which affect the helicopter in flight. These forces will cause the cargo to shift unless the cargo is restrained. To maintain helicopter balance and prevent injury to personnel, cargo must be restrained from shifting.

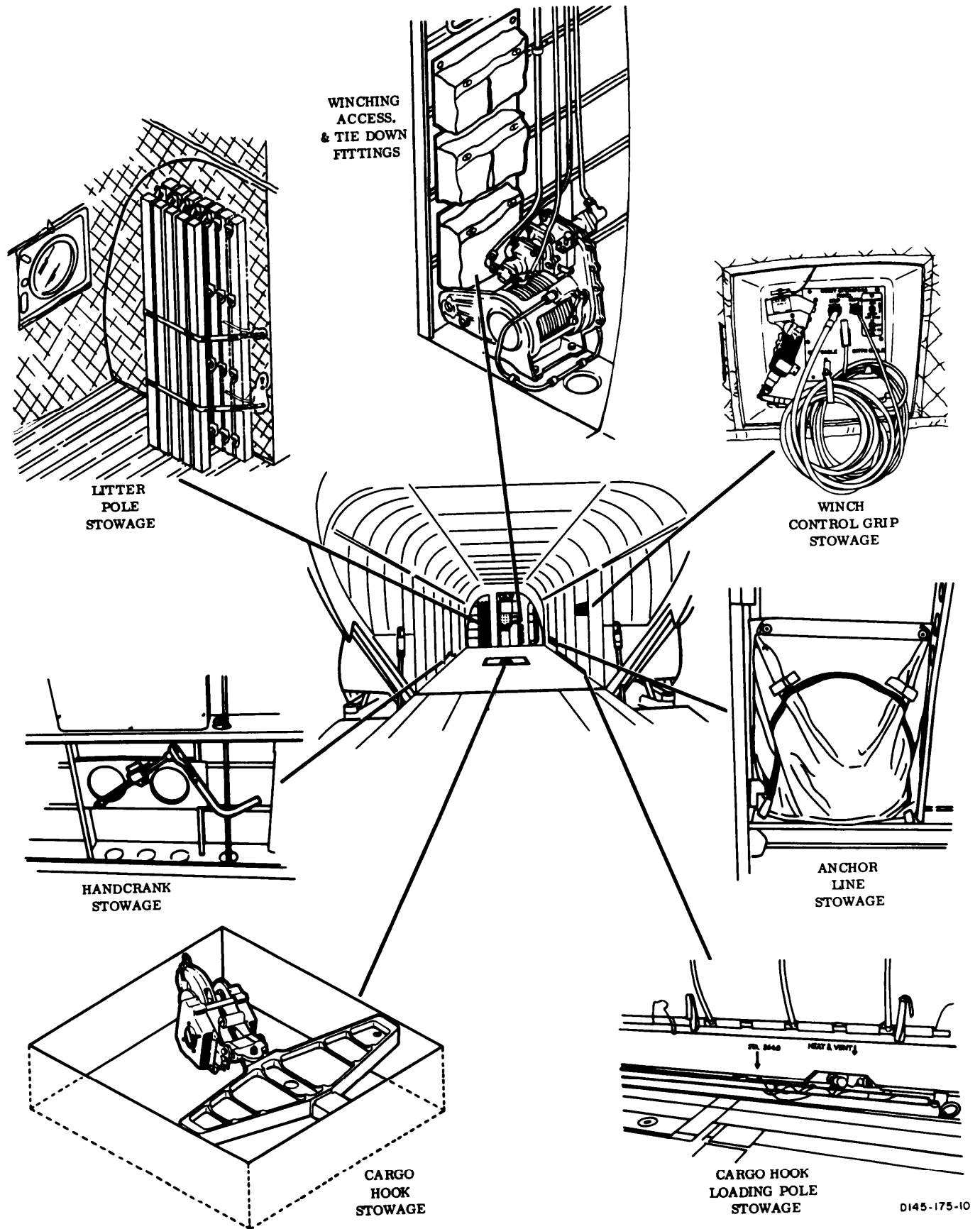


Figure 6-18. Stowage Locations

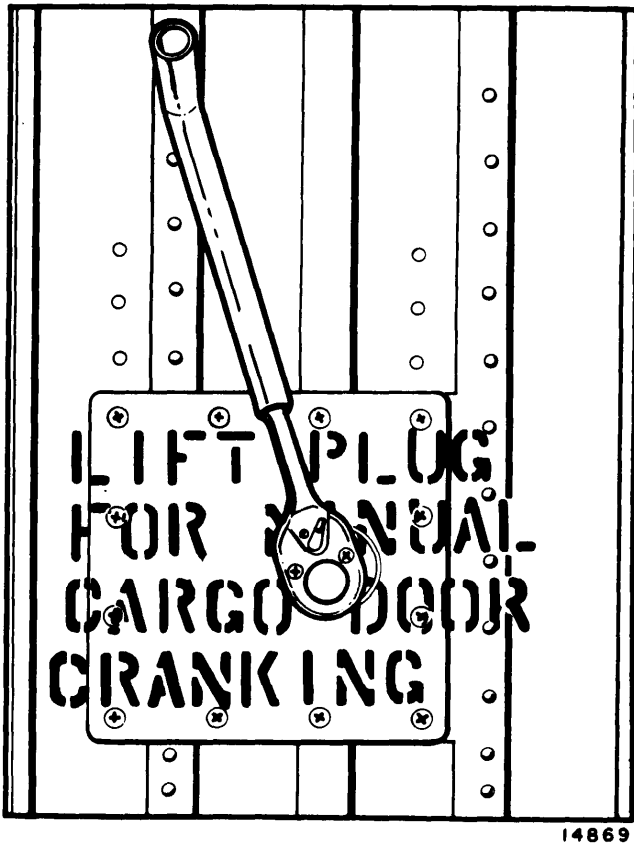


Figure 6-19. Cargo Door Cranking

#### 6-64. Load Planning.

Before loading cargo, the placement of individual items of cargo in the helicopter should be planned and then checked to determine if the planned arrangement falls within the C.G. limits. There are three basic steps involved in load planning. The first step is to decide which method will be used to compute the C.G. of the load. If the compartment method is to be used, each item of cargo must be assigned a location in one of the three compartments. If the station method is to be used, specific station locations must be assigned to each item of cargo. The second step is to compute the C.G. of the load. If the load consists of a number of items of cargo, the compartment method should be used. If the load consists of only a few bulky items, the station method should be used. The third step is to check if the C.G. falls within the allowable limits. If it does, the cargo can be loaded; if not, the location of individual items should be rearranged until an acceptable loading plan is obtained.

**6-65. Compartment Loading.** Loading by compartments provides a rapid means of computing the C.G. of a load and can be used whenever the cargo load consists of a number of items. The helicopter cargo compartment is divided into three compartments (fig. 6-20). The centroid, or center of balance, of each compartment is located at station 181, 303, and 425, respectively. When using the compartment method, it is assumed that the weight of all the cargo in the compartment is concentrated at the centroid of the compartment. If an item of

cargo extends into two or three compartments, the weight of the item should be proportionately distributed in each compartment. The C.G. of the cargo load is computed as follows:

- a. Record the weight of cargo in each compartment.
- b. Calculate the compartment moment by multiplying the total weight in each compartment by the station number of the compartment centroid.
- c. Add the compartment moments.
- d. Add the weight in all compartments.
- e. Divide the sums of the cargo moments by the total weight of the cargo. The result is the arm or the C.G. location of the load.

**6-66. Station Loading.** Loading by stations provides a more precise method of computing the C.G. of a load and should be used whenever possible (fig. 6-21). To use this method, it is necessary to know the C.G. of each item of cargo. If the C.G. of an item is not marked, it can be determined by the procedure given in FM 55-450-2. Station loading requires that the C.G. of each item placed in the helicopter coincides with a fuselage station number. The C.G. of the load is calculated as follows:

- a. Record the weight and station number of each item of cargo.
- b. Calculate the moment of each item by multiplying the weight of the item by the station number of its C.G.
- c. Add the moment of each item to obtain the total load moment.
- d. Add the weights of each item to obtain the total load weight.
- e. Divide the total load moment by the total load weight to obtain the arm or the C.G. location of the load.

**6-67. Vehicle Loading.** The same procedures observed in cargo loading apply to vehicle loading.

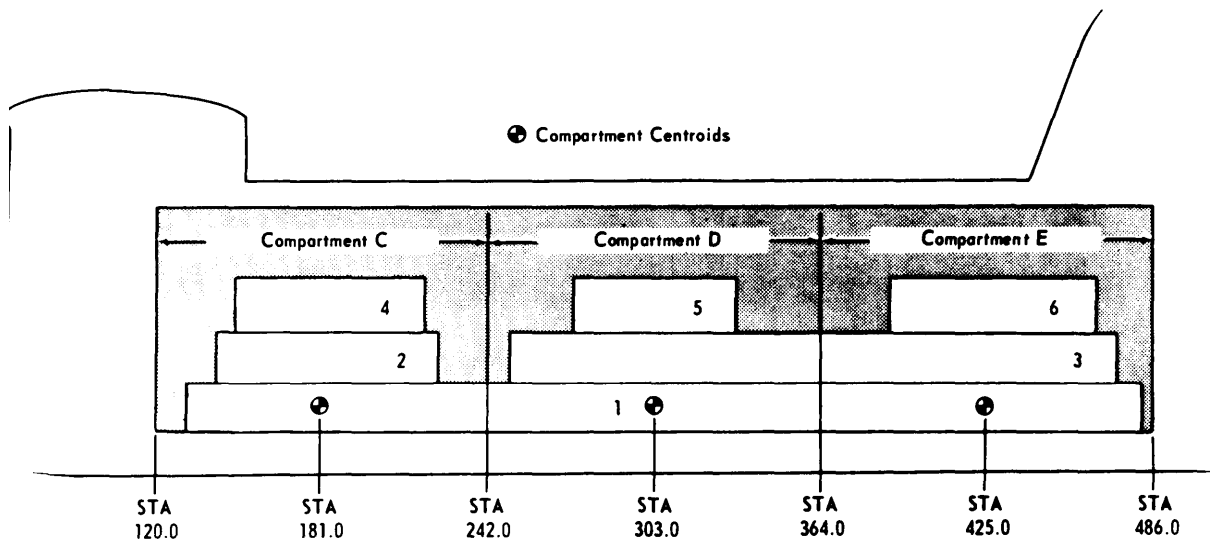
#### 6-68. Shoring.

Shoring is used to protect the cargo floor and to distribute load pressure over a greater area of the floor. Shoring can often make the difference between being able to carry a given load and not being able to; however, it is important not to exaggerate the effectiveness of shoring. Some vehicles have a tread width too narrow to allow the wheels to rest on the treadways. In this case, shoring must be used to reduce the contact pressure on the walkway to an allowable figure. In general, shoring is required for all wheeled platforms and dollies and for any item of cargo whose contact pressure exceeds the floor limitations.

#### 6-69. Securing Cargo.

The helicopter is subjected to forces which result from air turbulence, acceleration, rough or crash landings, and aerial maneuvers. These same forces act upon the cargo in the helicopter and tend to shift the cargo unless





**Example**

Problem: There are six items of cargo to be loaded. The weight of each item was found when the cargo was prepared for loading and is as follows:

Item 1	900 Pounds
Item 2	300 Pounds
Item 3	1,000 Pounds
Item 4	200 Pounds
Item 5	700 Pounds
Item 6	400 Pounds

Weight in C	300 (1/3 wt of item 1)
	300 (wt of item 2)
	200 (wt of item 4)
<b>Total Wt</b>	<b>800 Pounds in C</b>

Weight in D	300 (1/3 wt of item 1)
	500 (1/2 wt of item 3)
	700 (wt of item 5)
<b>Total Wt</b>	<b>1,500 Pounds in D</b>

Weight in E	300 (1/3 wt of item 1)
	500 (1/2 wt of item 3)
	400 (wt of item 6)
<b>Total Wt</b>	<b>1,200 Pound in E</b>

The loading plan is to locate items 2 and 4 in compartment C, item 5 in compartment D, and item 6 in compartment E. Item 1 and 3 are long and will be loaded so 1/3 of item 1 will be in compartments C, D, and E and 1/2 of item 3 will be in compartments D and E. Compute the CG of the total load.

**Total Weight in Helicopter**

800	in compartment C
1,500	in compartment D
1,200	in compartment E
<b>3,500</b>	<b>Total</b>

Solution: Since the load consists of several items, the compartment method is used to calculate the CG of the load. Refer to paragraph 6-79, for step by step instructions.

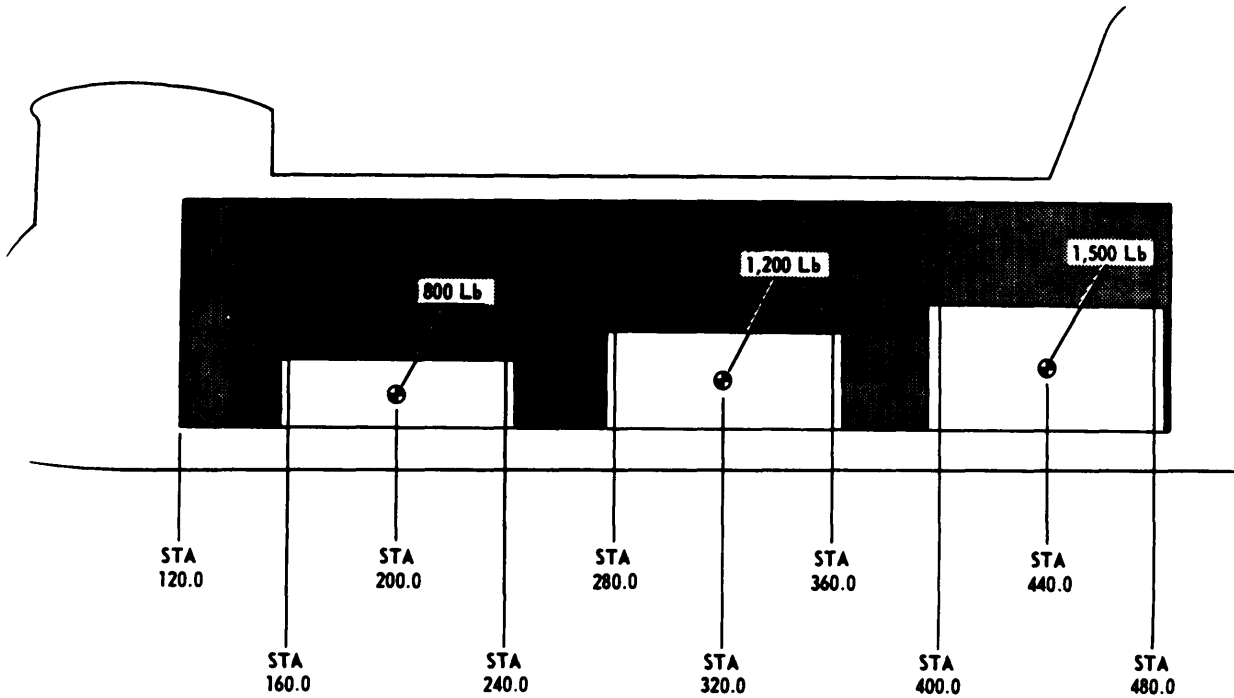
Total  
 Moment = (Total wt in compartment C) 181+  
 (Total wt in compartment D) 303+  
 (Total wt in compartment E) 425+  
 (800 X 181) + (1,500 X 303) + (1,200 X 425) =  
 1,109,300

$$CG = \frac{\text{Total Moment}}{\text{Total Weight}} = \frac{1,109,300}{3,500} = 317 \text{ (Station)}$$

Now that the center of gravity of the total load has been computed, compute the helicopter center of gravity.

14871

Figure 6-20. Compartment Loading



**Example**

**Problem:** Three items of cargo are to be loaded into the helicopter. The weight and center of gravity of each item was found when the cargo was prepared for loading and is indicated above. The loading plan is to locate these items at stations 200, 320, and 440. Compute the CG of the total load.

**Solution:** Since there are only three items, the station method is used to calculate the CG of the load. Refer to paragraph 6-79, for step by step instructions.

**Weight X Station Number    Moment**

Item 1	800 X 200	160,000
Item 2	1,200 X 320	384,000
Item 3	1,500 X 440	660,000

$$\text{CG of Load} = \frac{\text{Total Moment}}{\text{Total Weight}} = \frac{1,204,000}{3,500} = 344 \text{ (Station)}$$

**Total Weight 3,500    Total Moment 1,204,000**

Now that the center of gravity of the total load has been computed, compute the helicopter center of gravity.

14872

**Figure 6-21. Station Loading**

it is firmly secure. Forward motion of the helicopter is the most rapid movement that will be encountered and is the strongest force that is likely to act on the cargo if the helicopter is suddenly slowed or stopped in a crash landing. Other forces tending to shift the cargo aft, laterally, or vertically will be less severe. The amount of restraint required to keep the cargo from moving in any direction is called the restraint criterion and is expressed in units of the force of gravity, or g's. In each case, the maximum force exerted by the item of cargo to be restrained would be its normal weight times the number of g's of the restraint criteria. In order to safely carry cargo, the amount of restraint applied should equal or exceed the maximum amount of restraint required. Restraint is referred to by the direction in

which it keeps the cargo from moving. Forward restraint keeps the cargo from moving forward, aft restraint keeps the cargo from moving aft, and so on.

**6-70. Restraint Criteria.**

The following restraint factors are ultimate values and the minimum acceptable factors for crew and passenger safety.

<u>Direction</u>	<u>Restraint Criteria</u>
Forward	4.0 g's
Aft	2.0 g's
Down	4.0 g's
up	2.0 g's
Lateral	1.5 g's

**6-71. Restraint Devices.**

Refer to FM 55-450-2.

**6-72. Calculation of Tiedown Devices Required.**

Refer to FM 55-450-2.

**6-73. Tiedown Methods.**

Methods of applying restraint will vary depending on the type of cargo making up the load. Vehicles, crated objects, and assorted items of general cargo will require different methods of application. (Refer to FM 55-450-2 for restraint methods.)

**CAUTION**

**Excessive tightening of the tiedown straps attached to the outboard row of tiedown fittings will limit the effectiveness of the isolated floor.**

**6-74. Vehicle Tiedown.** Because of the numerous points of attachment available, vehicles are the items of cargo easiest to tie down. An MB-1 chain device should be used to restrain vehicle loads. These devices should be fastened to the 10,000-pound tiedown fittings whenever possible.

**6-75. Bulk Cargo Tiedown.** Typical methods of restraining large crates are shown in FM 55-450-2. If the crate is very heavy, an MB-1 tiedown device should be used to provide forward restraint and should be fastened to the 10,000-pound tiedown fittings.

**6-76. General Cargo Tiedown.** General cargo tiedown methods are shown in FM 55-450-2.

**6-77. 463 L Pallet/ Extended Range Fuel System (ERFS).**

The restraint criteria capability of a 463L pallet/ERFS loaded to 7,500 pounds is as follows.

<u>Direction</u>	<u>Load Factor</u>
Forward	6g plus 1.5g down
Aft	3g plus 1.5g down
Lateral	2.25g plus 1.5g down
Up	6g
Down	3g

**NOTE**

The HICHS can yield locally under the above loads, but ultimate failure cannot occur; that is the cargo (e.g., pallet, ERFS) cannot become a flying object when the above loads are applied. The above ultimate load factors shall be applied to the entire HICHS. All other cargo will be restrained to the normal restraint criteria as stated in this chapter.

**6-78. Loading Sequence.**

Refer to table 6-4 to select the proper configuration for system components during loading. Up to three pallets may be winched or manually loaded on the system. Loading clearances are shown in figures 6-22, 6-23, and 6-24.

**6-79. Warehouse Pallets.** Refer to table 6-4 to select the proper configuration for system components during loading. Up to 8 to 10 warehouse pallets can be loaded into the helicopter provided that the weight and C.G. requirements are within the limits specified as follows. The 40- inch side should be positioned across the handling system so that the 48-inch side is on the outboard rail. Pallets may be winched or manually loaded. During loading, the pallet should be fork lifted onto the ramp extension and balanced onto the ramp rollers. On the ramp, it should be pushed on board.

**NOTE**

All cargo must be properly restrained to ensure safe operation of the helicopter and safety of personnel. Loads must be restrained in accordance with procedures and guidelines in FM 55-450-2, Helicopter Internal Loads.

Individual warehouse pallets may weight up to **3,700 lbs.** However, to maintain floor isolation, the sum of the weights of longitudinally adjacent pallets must not exceed **4,300 lbs.** For example, pallets weighing 2,100 lbs or less may be loaded without discrimination; a mix of pallets weighing, for example, 3,000 lbs and 1,200 lbs, would require alternate loading of a 3,000 lb pallet and a 1,200 lb pallet. If the load consists entirely of pallets weighing in excess of 2,150 lbs, the pallets must be spaced longitudinally such that the distance, in inches, between the forward edge of one pallet and the forward edge of the subsequent pallet will not be less than  $W/45.2$  when **W** is the average pallet load in pounds. For example, load of pallets weighing 3,000 lbs each would need to be spaced  $3000/45.2 = 66$  inches center-to-center apart. Pallets that are spaced longitudinally will require tiedowns for longitudinal, lateral, and vertical forces. In this situation there is no requirement to use the barrier systems.

**6-80. Wheeled Vehicles.** Refer to table 6-4 to select the proper configuration for system components during

loading. Winch or manually load the vehicles into the helicopter.

**6-81. Personnel.**

The internal cargo handling system (HICHS), is compatible for personnel only or for both cargo and personnel. If both are loaded, the cargo should be forward of the personnel for safety.

**6-82. Miscellaneous Cargo.**

Place on a pallet or skid as desired. If a 6/E (463L) pallet is used, secure the pallet with the locks or retractable flanges. straps or chains may be used as required.

**6-83. Mixed Cargo.**

Any of the previous cargos may be mixed as desired. The only limitation is space.

**6-84. Load Dumping From Ramp.**

**CAUTION**

**Damage to the helicopter or load could occur when load dumping from the ramp. Make sure taxi surface is level and free of obstacles.**

Dumping from the ramp is not a routine operation, but under urgent conditions can be accomplished as follows:

- a. Helicopter at full stop.
- b. Remove ramp extensions and rollers if installed.
- c. Load released, but under control and moved to aft cabin ramp with ramp slightly in up position.

**WARNING**

**Crew members must remain clear of load.**

d. Helicopter taxis forward at approximately 5 knots ground speed. When 5 knots is reached, the ramp should be lowered and load pushed out the rear of the helicopter.

e. Repeat as required.

**6-85. Extended Range Fuel System (ERFS), ERFS II and FARE Kit Weight and Balance Data.**

Refer to figure 6-1, table 6-3 and 6-3.1.

The operator, upon configuration of ERFS II and FARE kit, must compute various fuel amounts to calculate combinations of weight and balance matching the mission requirements. table 6-3 lists the weights, ARM and moments of ERFS II and FARE kit installations.

**WARNING**

**Some combinations of ERFS II configuration and auxiliary fuel load will cause the helicopter to exceed weight and balance limits. It is the responsibility of the flight crew to ensure the helicopter center of gravity remains within operating limits at take-off and landing.**

Standard configuration for the ERFS II consists of three tank assemblies, fuel transfer hose assembly, fuel control panel, restraint system, FARE kit, and unusable fuel, with Tank 1 C.G. at 250 inches, Tank 2 C.G. at 330 inches, Tank 3 C.G. at 410 inches, and FARE kit C.G. at 464 inches.

**6-85.1. Restraint System Limits.**

The limitations of the restraint system are 8 G's forward, 3 G's aft, 8 G's vertical, and 8 G's lateral, measured with each tank one half full of fuel.

**6-85.2. Breaking Loads of Self Sealing Breakaway Valves.**

The breaking loads of the self sealing breakaway valves utilized in the ERFS II fuel and vent assemblies are: moment bending 750 lbs (±150 lbs) at 7 inches, and tension 4,300 lbs.

**Table 6-3. Extended Range Fuel System (ERFS) Weight and Balance Data**

Configuration	Weights/Balance	Station	Moments/1000
Fuel Tank 1	511.3	230.0	117.6
Fuel Tank 2	511.3	290.0	148.3
Fuel Tank 3	511.3	350.0	178.9
Fuel Tank 4	511.3	410.0	209.6
FMCP	48	190	9.1
Vent Lines	15	320	4.8
Pump Discharge Lines	20	290	5.8
Feed Lines/Manifold	70	290	20.3
Forward Area Refueling Equipment (FARE) (2 Pumps, 2 Filters, and 2 Fuel Cans)	800	502	401.6
HICKS	878	379.9	333.5
3/463L Pallets (290 lbs ea.)	870	323	281.0

**Table 6-3.1. Extended Range Fuel System II (ERFS II) Weight and Balance Data**

<b>Item</b>	<b>Weight (LBS)</b>	<b>Station (ARM)</b>	<b>Moment/1000</b>
Single-point Refuel Hose	23.0	240.0	5.5
<b>Total Weight and Moment</b>	<b>23.0</b>		<b>5.5</b>
ERFS II Tank 1 (Empty)	607.0	250.0	151.8
Unusable Fuel (5.5 gal JP-8)	37.0	250.0	9.0
Fuel Control Panel (FCP)	20.0	217.0	4.3
Vent Hose	10.0	235.0	2.4
Elect Harness, Hel to FCP	7.0	235.0	1.6
Elect Harness, FCP to Tank	8.0	238.0	1.9
Wiring Harness, Fuel Qty	5.0	240.0	1.2
Restraint Assembly	81.0	250.0	20.3
<b>Total Weight and Moment</b>	<b>775.0</b>		<b>192.5</b>
ERFS II Tank 2 (Empty)	607.0	330.0	200.3
Unusable Fuel (5.5 gal JP-8)	37.0	330.0	12.2
Elect Harness, FCP to Tank	8.0	278.0	2.2
Fuel Hose	15.0	285.0	4.3
Vent Hose	10.0	305.0	3.1
Restraint Assembly	81.0	330.0	26.7
<b>Total Weight and Moment</b>	<b>758.0</b>		<b>248.8</b>
ERFS II Tank 3 (Empty)	607.0	410.0	248.9
Unusable Fuel (5.5 gal JP-8)	37.0	410.0	15.2
Elect Harness, FCP to Tank	8.0	319.0	2.6
Fuel Hose	15.0	375.0	5.6
Vent Hose	10.0	385.0	3.9
Restraint Assembly	81.0	410.0	33.2
<b>Total Weight and Moment</b>	<b>758.0</b>		<b>309.4</b>
Fuel Hose, Main to ERFS II	29.0	363.0	10.5
Fuel Hose, Fuel Transfer	13.0	400.0	5.2
<b>Total Weight and Moment</b>	<b>42.0</b>		<b>15.7</b>
FARE Kit (Pump Module, hose, couplings, filters, meters, and nozzles)	592.0	464.0	274.7
<b>Total Weight and Moment</b>	<b>592.0</b>		<b>274.7</b>
<b>TOTAL ERFS II (including FARE) Weight and Moment</b>	<b>2,948.0</b>		<b>1046.6</b>

Table 6-4. Loading Sequence Configuration

<b>463L Pallet Configurations</b>		
<b><u>Configuration</u></b>	<b><u>Component</u></b>	<b><u>Comment</u></b>
<b>Load</b>	Outboard Rollers	Down
	Warehouse Guides	Down
	Ramp Extension/Ramp Jacks	In Place as Required
	Ramp Extension/Ramp Extension Rollers	In Place as Required
	Locks	Up (Unlock)
	Retractable Flange	Rotate Outboard (Unlock)
	5k/10k Rings	Down (Stowed Position)
	<b>Restraint</b>	Outboard Rollers
Warehouse Guides		—
Ramp Extension/Ramp Jacks		—
Ramp Extension/Ramp Extension Rollers		—
Locks		Down (Locked)
Retractable Flange		Rotate Inboard (Locked)
5k/10k Rings		—
<b>Flight</b>		Outboard Rollers
	Warehouse Guides	—
	Ramp Extension/Ramp Jacks	Stow in Helicopter
	Ramp Extension/Ramp Extension Rollers	Rotate Ramp Extension on Ramp, Rollers on Underside (Stowed Position)
	Locks	—
	Retractable Flange	—
	5k/10k Rings	—
	<b>Unload</b>	Outboard Rollers
Warehouse Guides		
Ramp Extension/Ramp Jacks		In Place as Required
Ramp Extension/Ramp Extension Rollers		In Place as Required
Locks		Up (Unlock)
Retractable Flange		Rotate Outboard (Unlock)
5k/10k Rings		—
<b>Warehouse Pallet Configurations</b>		
<b><u>Configuration</u></b>	<b><u>Component</u></b>	<b><u>Comment</u></b>
<b>Load</b>	Outboard Rollers	Down
	Warehouse Guides	Up
	Ramp Extension/Ramp Jacks	In Place as Required
	Ramp Extension/Ramp Extension Rollers	In Place as Required
	Locks	Down (Unlocked)
	Retractable Flange	Rotate Outboard (Unlock)
	5k/10k Rings	Up
	<b>Restraint</b>	Outboard Rollers
Warehouse Guides		—

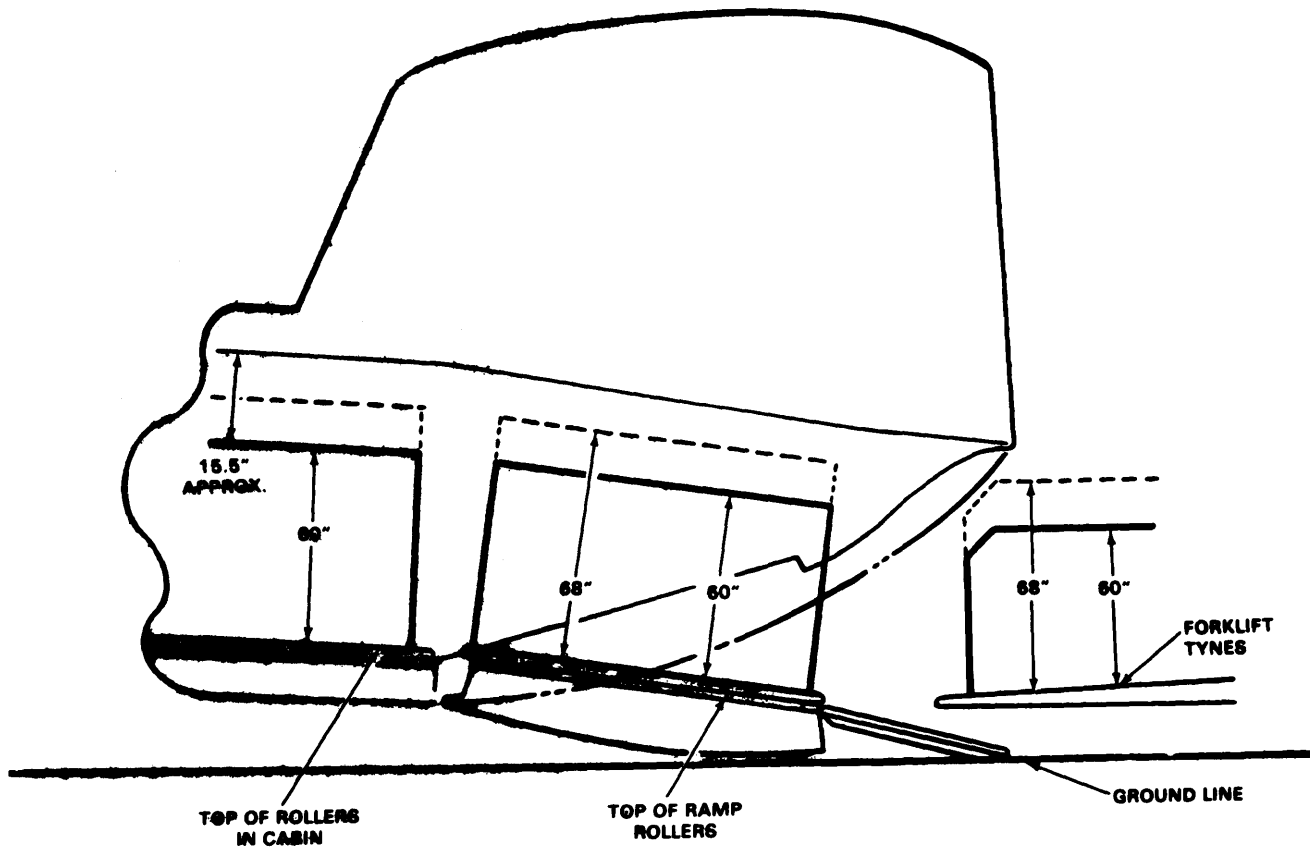
**Table 64. Loading Sequence Configuration (Continued)**

<b>Warehouse Pallet Configurations</b>		
<u>Configuration</u>	<u>Component</u>	<u>Comment</u>
	Ramp Extension/Ramp Jacks	—
	Ramp Extension/Ramp Extension Rollers	—
	Locks	—
	Retractable Flange	—
	5k/10k Rings	Using Straps, Secure Cargo to 5/10k Rings
<b>Flight</b>	Outboard Rollers	—
	Warehouse Guides	—
	Ramp Extension/Ramp Jacks	Stow in Aircraft
	Ramp Extension/Ramp Extension Rollers	Rotate Ramp Extension on Ramp, Rollers on Underside
	Locks	—
	Retractable Flange	—
	5k/10k Rings	—
<b>Warehouse Pallet Configurations</b>		
<u>Configuration</u>	<u>Component</u>	<u>Comment</u>
<b>Unload</b>	Outboard Rollers	—
	Warehouse Guides	—
	Ramp Extension/Ramp Jacks	In Place as Required
	Ramp Extension/Ramp Extension Rollers	In Place as Required
	Locks	—
	Retractable Flange	—
	5k/10k Rings	—
<b>Wheeled Vehicle Configurations</b>		
<u>Configuration</u>	<u>Component</u>	<u>Comment</u>
<b>Load</b>	Outboard Rollers*	Up-Straps on Cabin, Ramp Up
	Warehouse Guides	Down
	Ramp Extension/Ramp Jacks	No Ramp Extension Jacks, No Ramp Jack (Ramp on Ground)
	Ramp Extension/Ramp Extension Rollers	Ramp Extension on Ground, No Rollers
	Locks	Down (Locked)
	Retractable Flange	Rotate Outboard (Unlock)
	5k/10k Rings	Up
<b>Restraint</b>	Outboard Rollers	—
	Warehouse Guides	—
	Ramp Extension/Ramp Jacks	—
	Ramp Extension/Ramp Extension Rollers	—
	Locks	—
	Retractable Flange	—

**Table 6-4. Loading Sequence Configuration (Continued)**

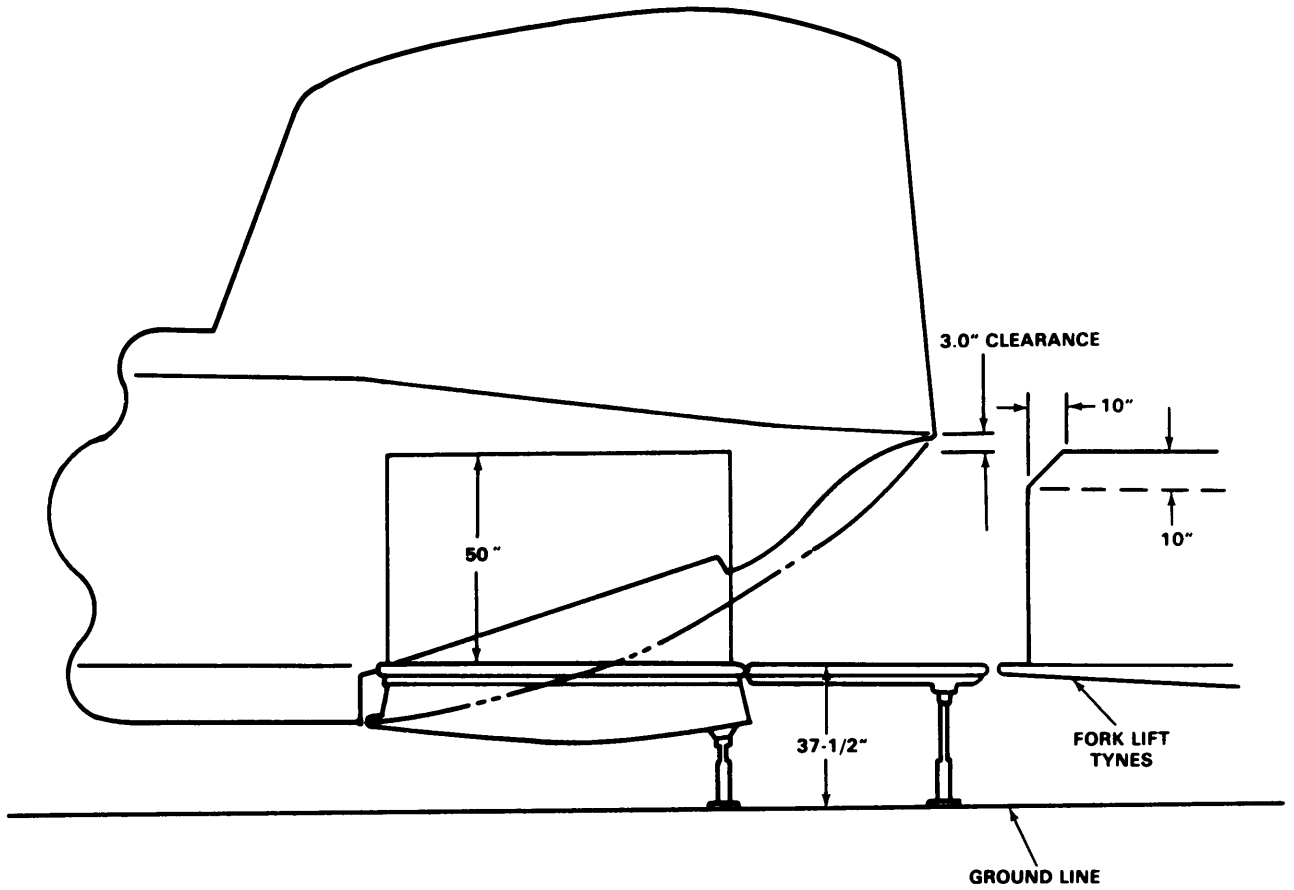
<b>Wheeled Vehicle Configurations</b>		
<b><u>Configuration</u></b>	<b><u>Component</u></b>	<b><u>Comment</u></b>
	5k/10k Rings	Using Straps and/or Chains, Secure Cargo to 5k/10k Rings
<b>Flight</b>	Outboard Rollers	—
	Warehouse Guides	—
	Ramp Extension/Ramp Jacks	Stow in Helicopter
	Ramp Extension/Ramp Extension Rollers	Rotate Ramp Extension on Ramp, Rollers on Underside
	Locks	—
	Retractable Flange	—
	5k/10k Rings	—
<b>Unload</b>	Outboard Rollers	—
	Warehouse Guides	
	Ramp Extension/Ramp Jacks	Ramp on Ground
	Ramp Extension/Ramp Extension Rollers	Ramp Extension on Ground
	Locks	—
	Retractable Flange	—
<b>Wheeled Vehicle Configurations</b>		
<b><u>Configuration</u></b>	<b><u>Component</u></b>	<b><u>Comment</u></b>
	5k/10k Rings	*Maximum available width with outboard rollers in stowed position is 85 inches lateral width.





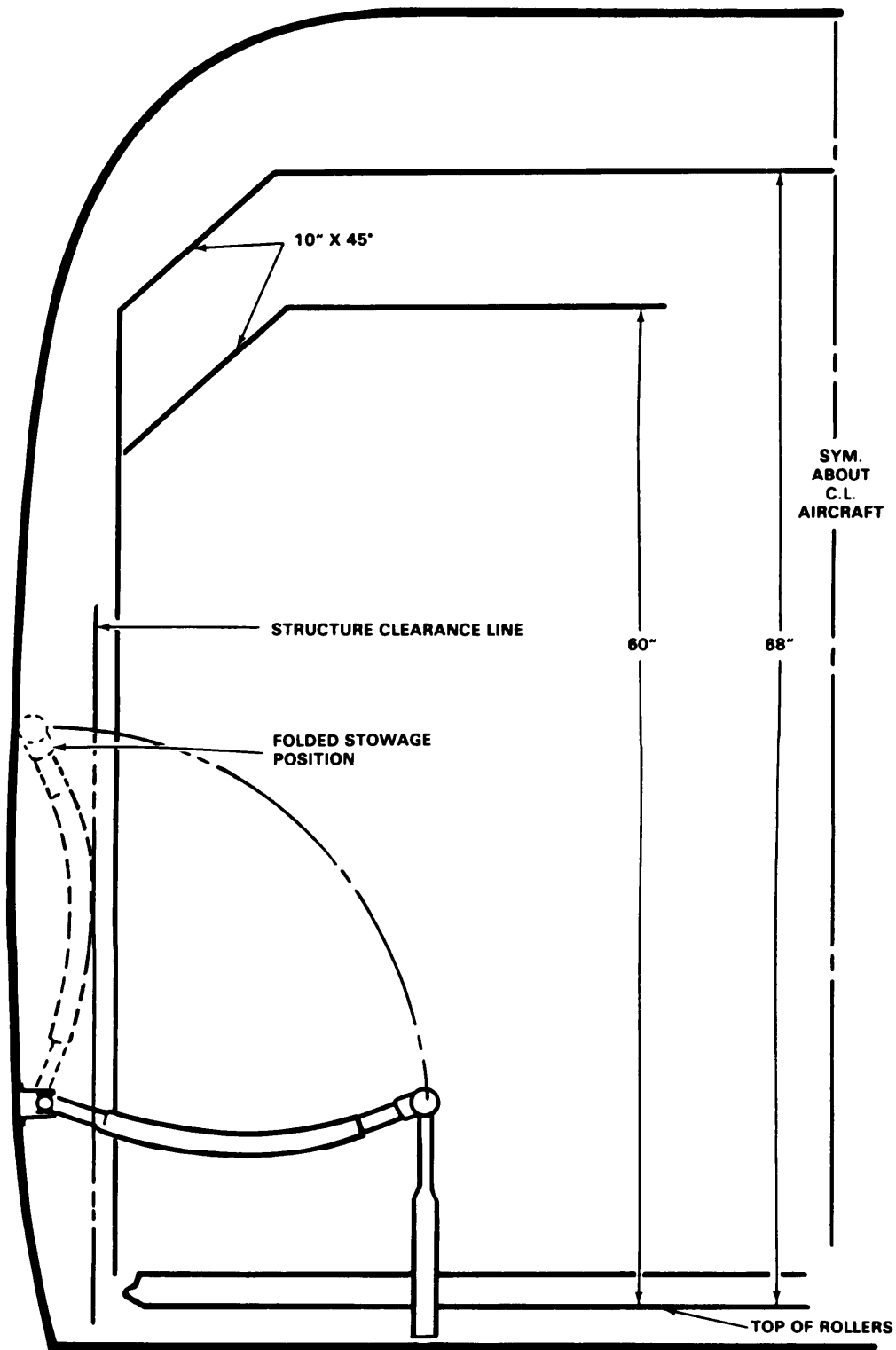
13042

Figure 6-22. Loading With Ramp Down (Forklift Loading)



13941

Figure 6-23. Loading With Ramp In Level Position



13940

Figure 6-24. Load Clearances

## SECTION VII LOADING LIMITS

### **6-86. General.**

The loading limits are depicted on figure 6-25. Using loading techniques specified in this chapter, it would be difficult to exceed these limits.

**CENTER OF GRAVITY LIMITS**

**ARM - INCHES**

**EXAMPLE**

**WANTED**

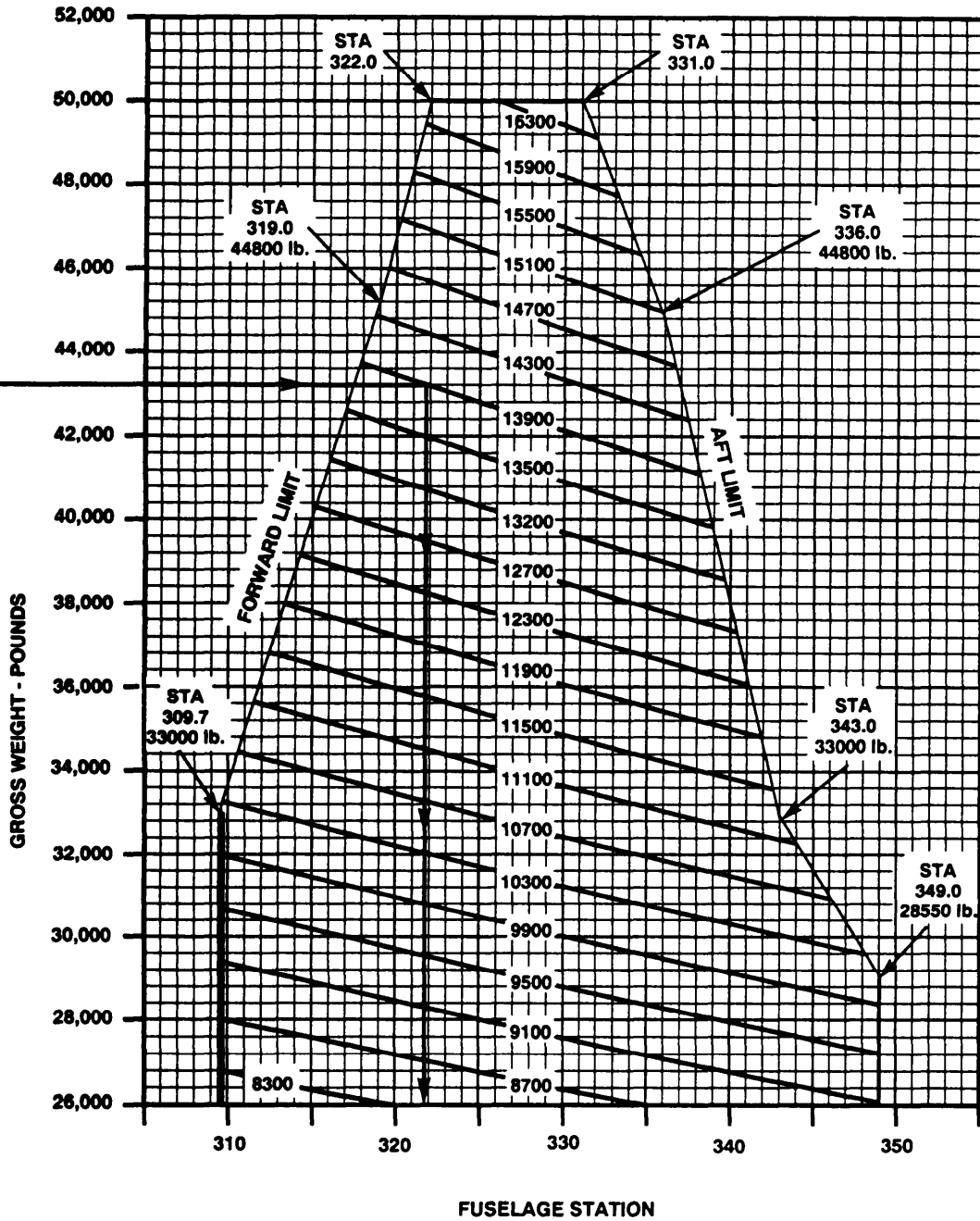
**DETERMINE IF  
LOADING LIMITS  
ARE EXCEEDED  
AND DETERMINE  
C.G. POSITION**

**KNOWN**

**GW = 43200 LBS  
MOMENT/1000  
= 13900**

**METHOD**

**ENTER GROSS  
WEIGHT HERE  
MOVE RIGHT TO  
TOTAL MOMENT =  
13900. READ LOAD  
WITHIN LIMITS  
MOVE DOWN READ  
ARM = 321.8**



A24977

Figure 6-25. C.G. Limits Chart

## CHAPTER 7 PERFORMANCE DATA

### SECTION I INTRODUCTION

#### 7-1. Purpose.

The purpose of this chapter is to provide the best available performance data for the CH-47D helicopter. Regular use of this information will enable you to receive maximum safe utilization from the aircraft. Although maximum performance is not always required, regular use of this chapter is recommended for the following reasons.

- a. Knowledge of your performance margin will allow you to make better decisions when unexpected conditions or alternate missions are encountered.
- b. Situations requiring maximum performance will be more readily recognized.
- c. Familiarity with the data will allow performance to be computed more easily and quickly.
- d. Experience will be gained in accurately estimating the effects of variables for which data are not presented.

#### 7-2. General Data.

The data presented covers the maximum range of conditions and performance that can reasonably be expected. In each area of performance, the effects of altitude, temperature, gross weight (GW), and other parameters relating to that phase of flight are presented. In addition to the presented data, your judgment and experience will be necessary to accurately obtain performance under a given set of circumstances. The conditions for the data are listed under the title of each chart. The effects of different conditions are discussed in the text accompanying each phase of performance. Where practical, data is presented at conservative conditions. However, **NO GENERAL CONSERVATISM HAS BEEN APPLIED**. All performance data presented is within the applicable limits of the aircraft.

#### **CAUTION**

**Exceeding operating limits can cause permanent damage to critical components. Over limit operation can decrease performance, cause immediate failure, or failure on a subsequent flight.**

#### 7-3. Limits.

Applicable limit lines are shown on the charts. The dashed lines on the cruise charts are estimated airspeed

limits with an operating cruise guide indicator (CGI). Airspeed limits with the CGI inoperative are in Chapter 5. If limits are exceeded, minimize the degree and time.

#### 7-4. Use of Charts.

a. *Chart Explanation.* The first page of each section describes the chart(s) and explains its use.

b. The primary use of each chart is given in an example and a guideline is provided to help you follow the route through the chart. The use of a straight edge (ruler or page edge) and a hard fine point pencil is recommended to avoid cumulative errors. The majority of the charts provide a standard pattern for use as follows: enter first variable on top left scale, move right to the second variable, deflect down at right angles to the third variable, deflect left at right angles to the fourth variable, deflect down, etc. until the final variable is read out at the final scale. In addition to the primary use, other uses of each chart are explained in the text accompanying each set of performance charts.

#### **NOTE**

An example of an auxiliary use of the charts referenced above is as follows: Although the hover chart is primarily arranged to find torque required to hover, by entering torque available as torque required, maximum wheel height for hover can also be found. In general, any single variable can be found if all others are known. Also, the tradeoffs between variables can be found. For example, at a given density altitude (DA) and pressure altitude (PA), you can find the maximum GW capability as free air temperature (FAT) changes.

c. *Dashed Line Data.* Data beyond conditions for which tests were conducted, or for which estimates are used, are shown as dashed lines.

#### 7-5. Data Basis.

The type of data used is indicated at the bottom of each performance chart under DATA BASIS. The applicable report and date of the data are also given. The data provided generally is based on one of the following categories.

a. *Flight Test Data.* Data obtained by flight test of the aircraft by experienced flight test personnel at precise conditions using sensitive calibrated instruments.

b. *Calculated Data.* Data based on tests, but not on flight test of the complete aircraft.

c. *Estimated Data.* Data based on estimates using aerodynamic theory or other means but not verified by flight test.

#### 7-6. Specific Conditions.

The data presented is accurate only for specific conditions listed under the title of each chart. Variables for which data are not presented, but which may affect that phase of performance, are discussed in the text. Where data is available or reasonable estimates can be made, the amount that each variable affects performance will be given.

#### 7-7. General Conditions.

In addition to the specific conditions, the following general conditions are applicable to the performance data.

a. *Rigging.* All airframe and engine controls are assumed to be rigged within allowable tolerances.

b. *Pilot Technique.* Normal pilot technique is assumed.

c. *Aircraft Variation.* Variations in performance between individual aircraft are known to exist; however, they are considered to be small and cannot be accounted for individually.

d. *Instrument Variations.* The data shown in the performance charts does not allow for instrument inaccuracies or malfunctions.

e. *Airspeed Calibrations.* The airspeed calibration chart presents the difference between indicated air speed (IAS), and calibrated airspeeds (CAS) for different flight conditions.

f. Except as noted, all data is for a clean configuration (all doors installed, without armament).

g. *Types of Fuel.* All flight performance data is based on JP-5 fuel. The change in fuel flow and torque available, when using JP-4, JP-8, Aviation gasoline or any other approved fuels, is insignificant.

#### 7-7.1. ERFS II Performance Data.

Use of the performance data will enable the operator to receive the maximum safe utilization of the ERFS II and FARE kit.

#### 7-7.2. ERFS II Tank Capacity.

The capacity of the ERFS II tank using pressure refueling is 805.5 US gallons. If filled using gravity refueling, the capacity is 825.5 US gallons (In both cases 5.5 GALS will be unusable).

#### 7-7.3. Amount of Unusable Fuel.

The amount of unusable fuel in each of the ERFS II tanks is 5.5 US gallons of JP-8.

#### 7-7.4. Fuel Transfer Rate.

The rate at which fuel is transferred from the ERFS II tanks to the helicopter main fuel tanks is 23 GPM.

#### 7-7.5. FARE Transfer Rate.

The FARE kit pump is rated at 120 GPM. However, the configuration of the FARE fuel transfer hose assembly affects this transfer rate. Pressure losses across couplings, filters, and nozzles reduce the flow rate below the rated value. The rate at which fuel is transferred from the ERFS II tanks using the FARE pump and the standard configuration of the FARE fuel transfer hose assembly is 84 to 88 GPM.

#### 7-8. Performance Discrepancies.

Regular use of this chapter will allow you to monitor instruments and other aircraft systems for malfunction, by comparing actual performance with planned performance. Knowledge will also be gained concerning the effects of variables for which data are not provided, thereby increasing the accuracy of performance predictions.

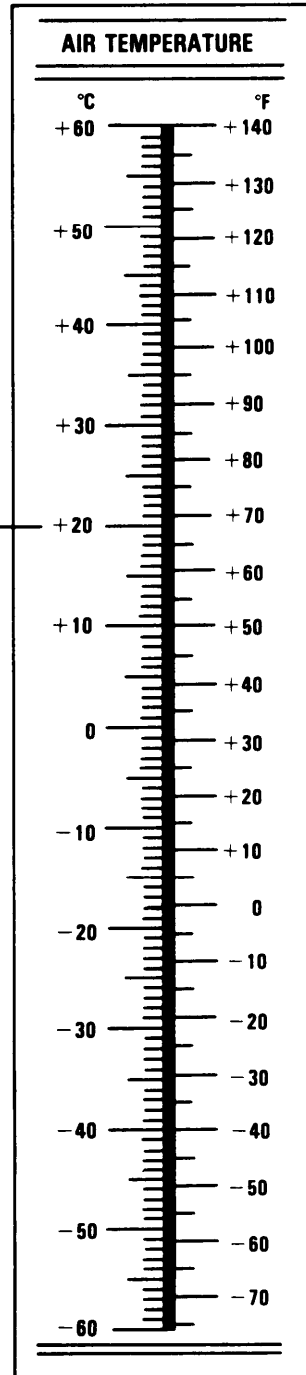
#### 7-9. Definitions of Abbreviations.

Capitalization and punctuation of abbreviations varies, depending upon the context in which they are used. In general, full capital letter abbreviations are used in text material, charts and illustrations. Periods do not usually follow abbreviations; however, periods are used with abbreviations that could be mistaken for whole words if the period were omitted.

TEMPERATURE  
CONVERSION

# TEMPERATURE CONVERSION CHART

**EXAMPLE**  
**WANTED**  
 FAT IN DEGREES FARENHEIT °F  
**KNOWN**  
 FAT = 20°C  
**METHOD**  
 ENTER FAT (°C) HERE →  
 MOVE RIGHT AND READ  
 FAT = 68°F



16017

Figure 7-1. Temperature Conversion Chart



## SECTION II EMERGENCY TORQUE AVAILABLE

### 7-10. Emergency Torque Available.

Single engine emergency torque available may be obtained from figure 7-2. Available torque is presented in terms of PA and FAT.

### 7-11. Use of Chart.

The primary use of the chart is to determine available engine torque for various combinations of PA and

temperature. To determine torque available, it is necessary to know PA, and FAT. Enter the left side of the chart at known temperature, move right to known pressure altitude, then down to read torque available.

### 7-12. Conditions.

The chart is based on a rotor speed of 100%.

## SINGLE ENGINE EMERGENCY TORQUE AVAILABLE

100% ROTOR RPM

JP-4 FUEL

TAS=0 KN

**EMERGENCY TORQUE**  
**CH-47D**  
**(2) T55-L-712**

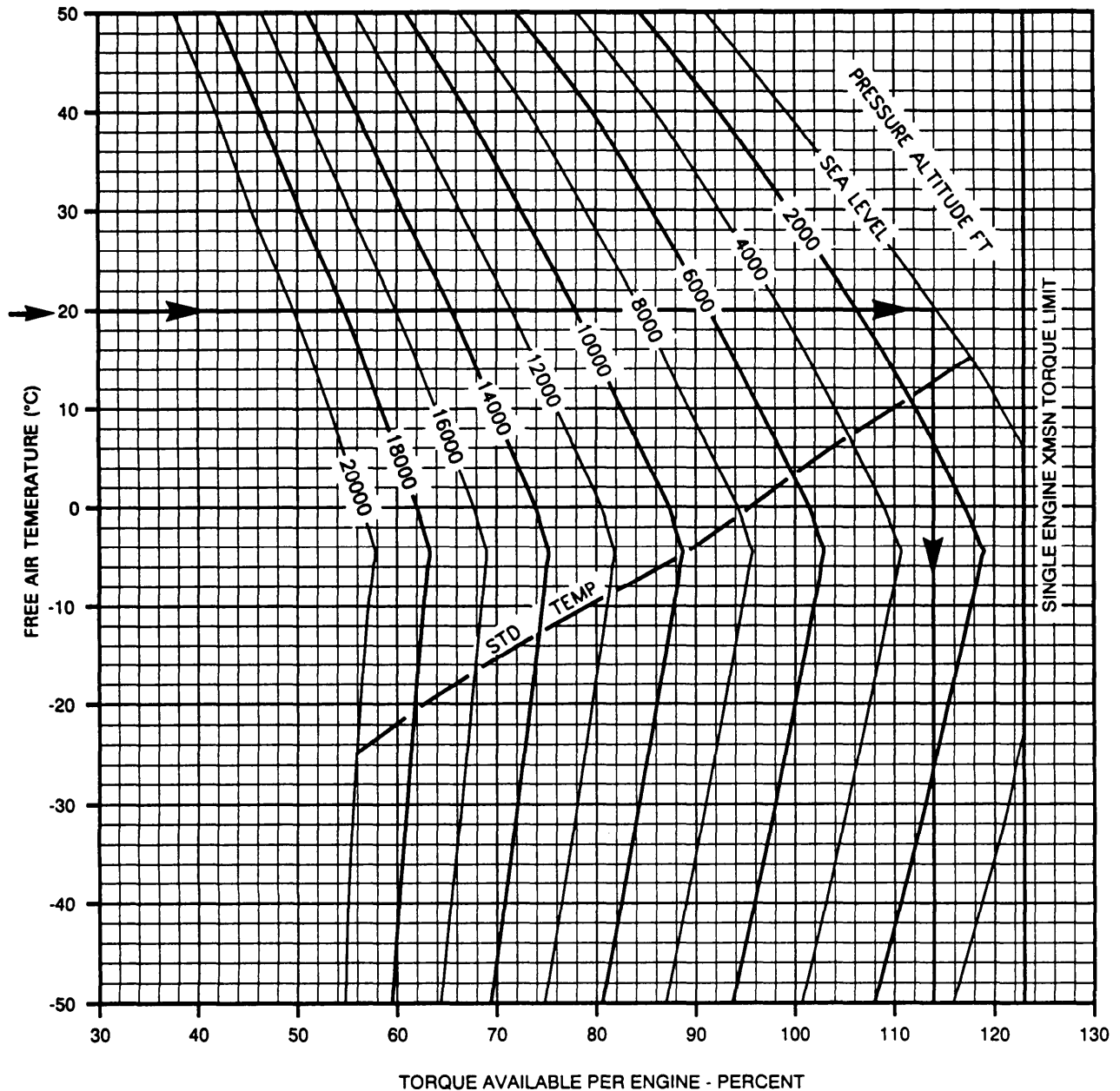
**EXAMPLE**

**WANTED**  
 EMERGENCY TORQUE AVAILABLE FOR SINGLE ENGINE OPERATION

**KNOWN**  
 PRESSURE ALTITUDE = SEA LEVEL/FAT = 20°C

**METHOD**

**SINGLE ENGINE OPERATION**  
 ENTER FAT AT 20°C MOVE RIGHT TO  
 PRESSURE ALTITUDE = SEA LEVEL  
 MOVE DOWN TO READ EMERGENCY TORQUE  
 AVAILABLE PER ENGINE = 114.0 PERCENT



DATA BASIS: CALCULATED FROM MODEL SPEC 124.53(B) AND FLIGHT TEST

A9727

Figure 7-2. Emergency Torque Available

## SECTION III MAXIMUM TORQUE AVAILABLE

### 7-13. Maximum Torque Available (10-Minute Operation).

Maximum torque available (10-minute operation) may be obtained from figure 7-3. Available torque is presented in terms of pressure altitude and free air temperature.

### 7-14. Use of Chart.

The primary use of the chart is to determine available engine torque for various combinations of pressure altitude and temperature. To determine torque available, it is necessary to know pressure altitude and free air temperature. Enter the left side of the chart at known temperature, move right to known pressure altitude, then down to read torque available.

### 7-15. Conditions.

The chart is based on a rotor speed of 100%.

### 7-16. Maximum Torque Available (30-Minute Operation).

Maximum torque available (30-minute operation) may be obtained from figure 7-4. Available torque is presented in terms of PA and FAT.

### 7-17. Use of Chart.

The primary use of the chart is to determine available engine torque for various combinations of PA and temperature. To determine torque available, it is necessary to know pressure altitude and free air temperature. Enter the left side of the chart at the known pressure altitude, move right to known temperature, then down to read intermediate torque available.

### 7-18. Conditions.

The chart is based on a rotor speed of 100%.

### MAXIMUM TORQUE AVAILABLE (10 MIN. OPERATION)

**MAXIMUM TORQUE**  
CH-47D  
T55-L-712

**100% ROTOR RPM**

**JP-4 FUEL**

**TAS=0 KN**

**EXAMPLE**

**METHOD**

**WANTED**

**SINGLE ENGINE OPERATION**

MAXIMUM TORQUE AVAILABLE FOR SINGLE AND DUAL ENGINE OPERATION

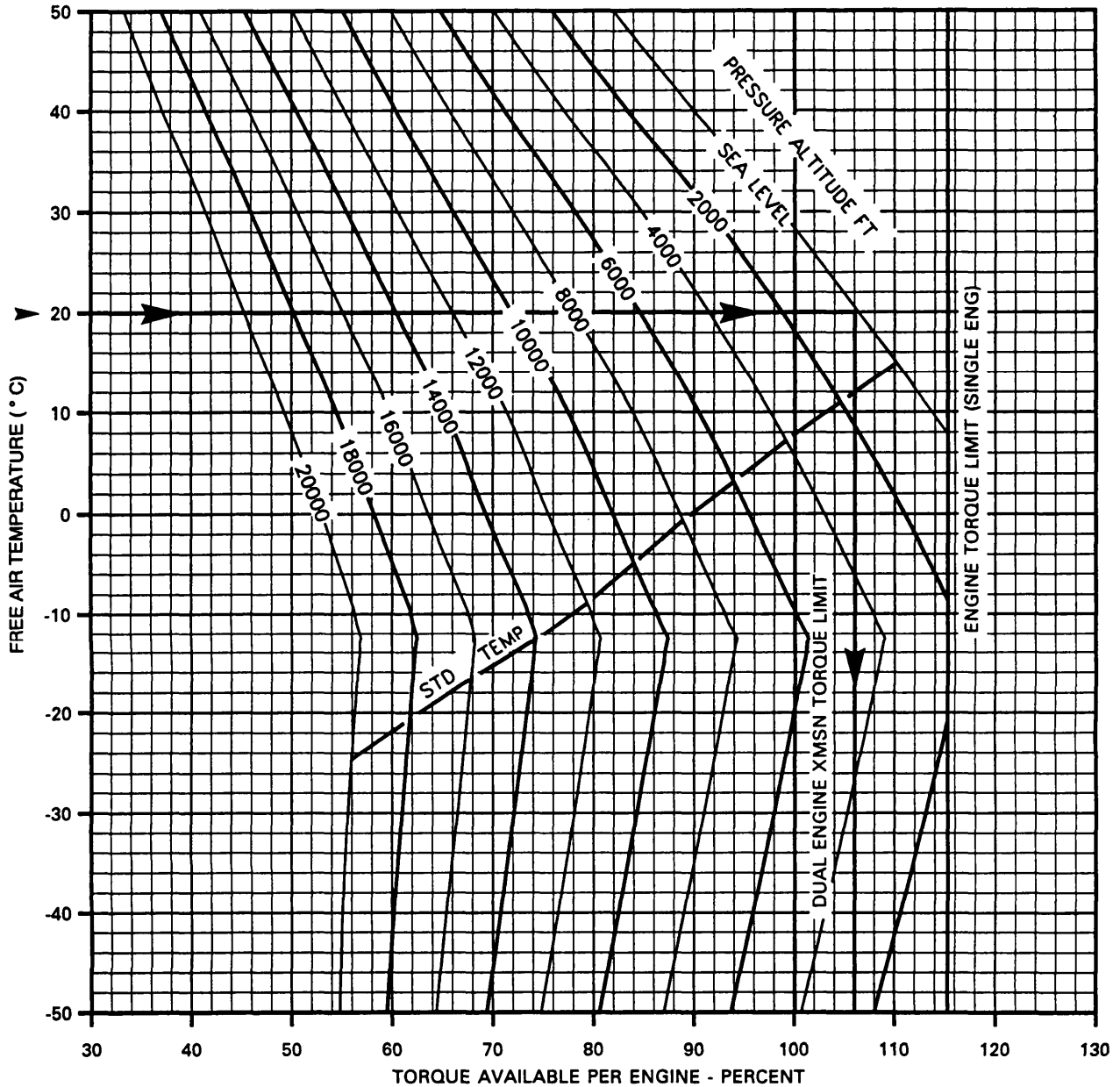
ENTER FAT AT 20°C MOVE RIGHT TO PRESSURE ALTITUDE = SEA LEVEL MOVE DOWN READ MAXIMUM TORQUE AVAILABLE PER ENGINE = 106.0 PERCENT

**DUAL ENGINE OPERATION**

**KNOWN**

PRESSURE ALTITUDE = SEA LEVEL /FAT = 20°C

ENTER FAT AT 20°C MOVE RIGHT TO PRESSURE ALTITUDE = SEA LEVEL OR DUAL ENGINE XMSN TORQUE LIMIT. MOVE DOWN READ MAXIMUM TORQUE AVAILABLE PER ENGINE = 100.0 PERCENT



DATA BASIS: CALCULATED FROM MODEL SPEC 124.53(B) AND FLIGHT TEST

A9728

Figure 7-3. Maximum Torque Available (10-Minute Operation)

### MAXIMUM TORQUE AVAILABLE (30 MIN OPERATION)

100% ROTOR RPM

JP-4 FUEL

TAS=0 KN

MAXIMUM TORQUE  
CH-47D  
(2) T55-L-712

**EXAMPLE**

WANTED

MAXIMUM TORQUE AVAILABLE FOR  
SINGLE AND DUAL ENGINE OPERATION

**METHOD**

SINGLE ENGINE OPERATION

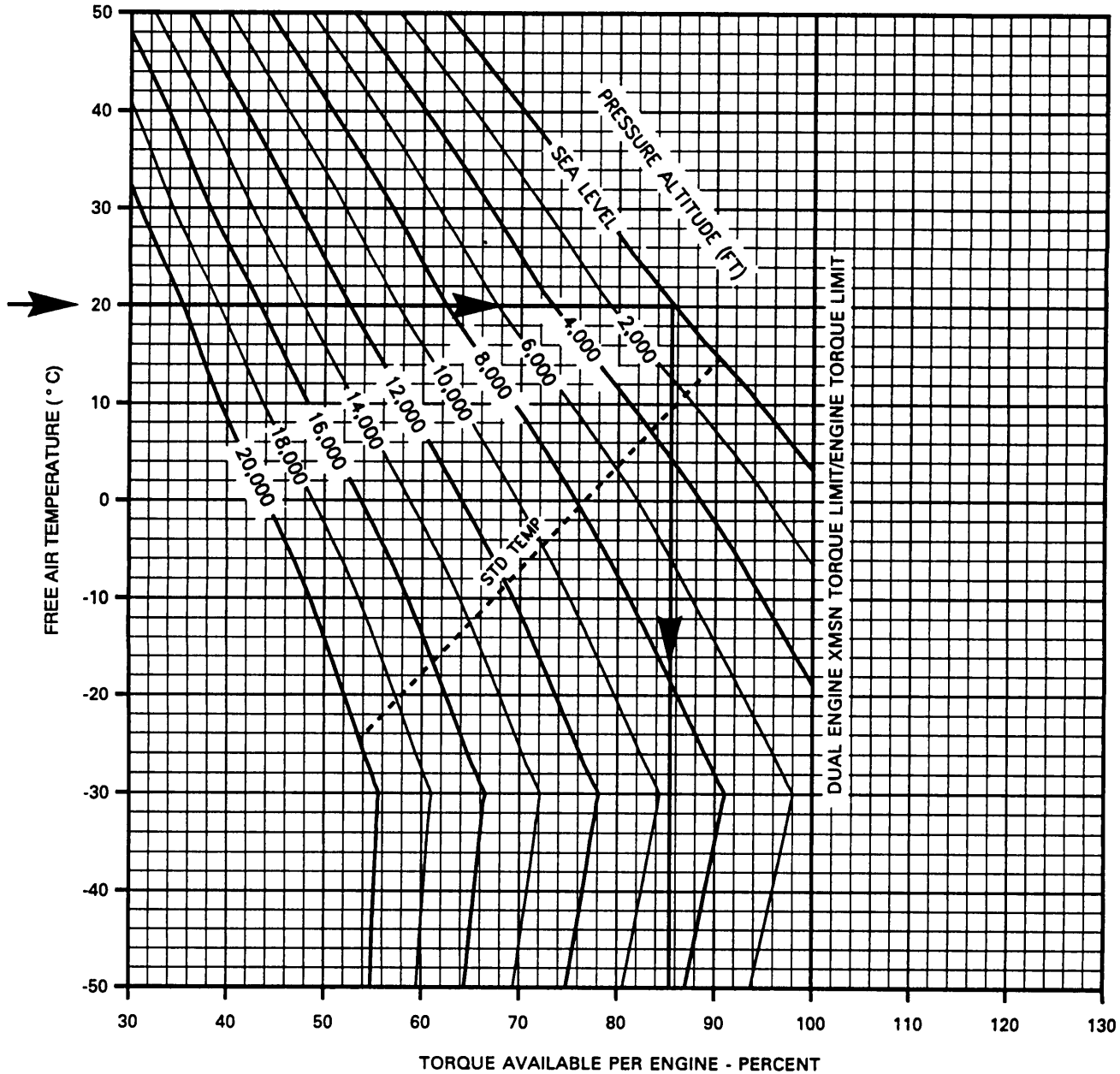
ENTER FAT AT 20°C MOVE RIGHT TO PRESSURE ALTITUDE = SEA LEVEL  
SEA LEVEL. MOVE DOWN, READ TORQUE AVAILABLE  
PER ENGINE = 85.4 PERCENT

DUAL ENGINE OPERATION

ENTER FAT AT 20°C MOVE RIGHT TO PRESSURE ALTITUDE = SEA LEVEL  
SEA LEVEL. MOVE DOWN, READ MAXIMUM TORQUE AVAILABLE  
PER ENGINE = 85.4 PERCENT

KNOWN

PRESSURE ALTITUDE = SEA LEVEL/FAT = 20°C



DATA BASIS: CALCULATED FROM MODEL SPEC 124.53(B) AND FLIGHT TEST

A9729

Figure 7-4. Maximum Torque Available (30-Minute Operation)



## SECTION IV CONTINUOUS TORQUE AVAILABLE

### 7-19. Continuous Torque Available.

Continuous torque available may be obtained from figure 7-5. Available torque is presented in terms of PA and FAT.

### 7-20. Use of Chart.

The primary use of the chart is to determine available engine torque for various combinations of PA and

temperature. To determine torque available, it is necessary to know PA and FAT. Enter the left side of the chart at known temperature, move right to known pressure altitude, then down to read torque available.

### 7-21. Conditions.

The chart is based on a rotor speed of 100%.

# CONTINUOUS TORQUE AVAILABLE

CONTINUOUS TORQUE  
CH-47D  
(2) T55-L-712

100% ROTOR RPM

JP-4 FUEL

TAS=0 KN

**EXAMPLE**

**WANTED**

CONTINUOUS TORQUE AVAILABLE  
FOR SINGLE AND DUAL  
ENGINE OPERATION

**METHOD**

**SINGLE ENGINE OPERATION**

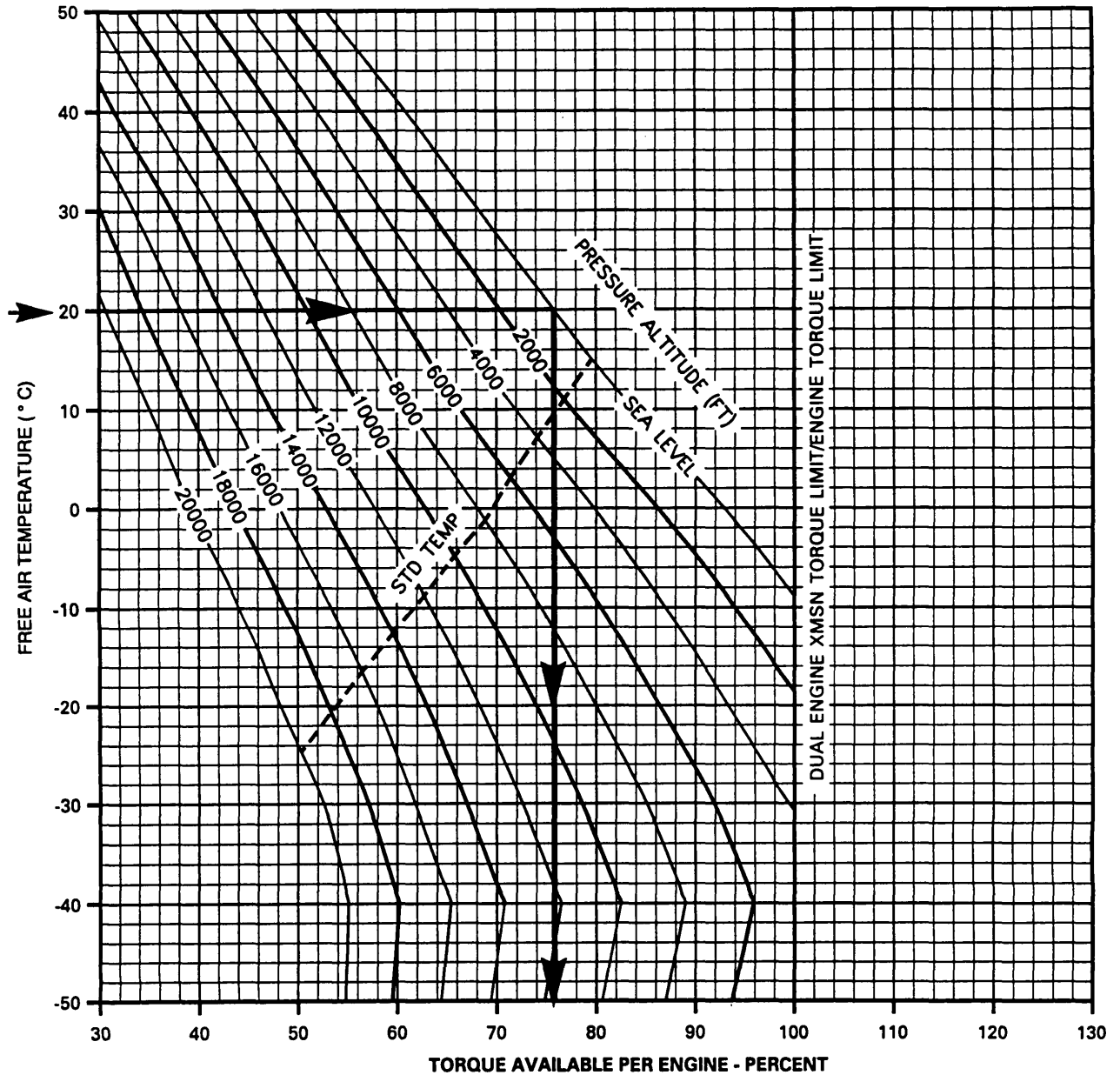
ENTER FAT AT 20°C MOVE RIGHT TO PRESSURE ALTITUDE = SEA LEVEL  
MOVE DOWN READ CONTINUOUS TORQUE AVAILABLE PER ENGINE = 75.7 PERCENT

**KNOWN**

PRESSURE ALTITUDE =  
SEA LEVEL/FAT = 20°C

**DUAL ENGINE OPERATION**

ENTER FAT AT 20°C MOVE RIGHT TO PRESSURE ALTITUDE = SEA LEVEL  
MOVE DOWN READ CONTINUOUS TORQUE AVAILABLE PER ENGINE = 75.7 PERCENT



DATA BASIS: CALCULATED FROM MODEL SPEC 124.53(B) AND FLIGHT TEST

A9730

Figure 7-5. Continuous Torque Available



## SECTION V HOVER

### 7-22. DESCRIPTION.

The hover chart, figure 7-6, presents torque required to hover at 100% RRPM at various combinations of PA, FAT, GW, and wheel height for single and dual engine operation.

### 7-23. Use of Chart.

a. The primary use of the charts is illustrated by the example. To determine the torque required to hover, it is necessary to know PA, FAT, GW, and desired wheel height. Enter the upper right grid at the known pressure altitude, move right to the temperature, move down to gross weight. Move left to desired wheel height, deflect down and read torque required for dual engine or single engine operation.

b. In addition to the primary use, the hover ceiling charts (fig. 7-7) may be used to predict maximum hover height. This information is necessary for use of the takeoff chart found in figure 7-8. To determine maximum hover height, it is necessary to know PA, FAT, GW, and maximum torque available. Enter at the known pressure altitude, move right to FAT, move down to gross weight, move left to intersection with

maximum torque available and read wheel height. This wheel height is the maximum hover height,

c. The hover charts may also be used to determine maximum GW for hover at a given wheel height, PA, and temperature. Enter at known pressure altitude, move right to the FAT, then move down to the bottom of the lower grid, and read density altitude. Now enter lower left grid at maximum torque available. Move up to wheel height, then move right to density altitude and read GW. This is the maximum gross weight at which the helicopter will hover.

### 7-24. Conditions.

a. The hover chart is based on calm wind, level surface, and 100% RRPM.

b. Hover in ground effect (HIGE) data is based on hovering over a level surface. For normal transition from hover to forward flight, the minimum hover wheel height should be **10** feet to prevent ground contact. If helicopter is to hover over a surface known to be steep, covered with vegetation, or if type of terrain is unknown, the flight should be planned for hover out of ground effect (HOGE) capability.

# HOVER

100% ROTOR RPM

CALM WIND

LEVEL SURFACE

HOVER  
CH-47D  
(2) T55-L-712

## EXAMPLE

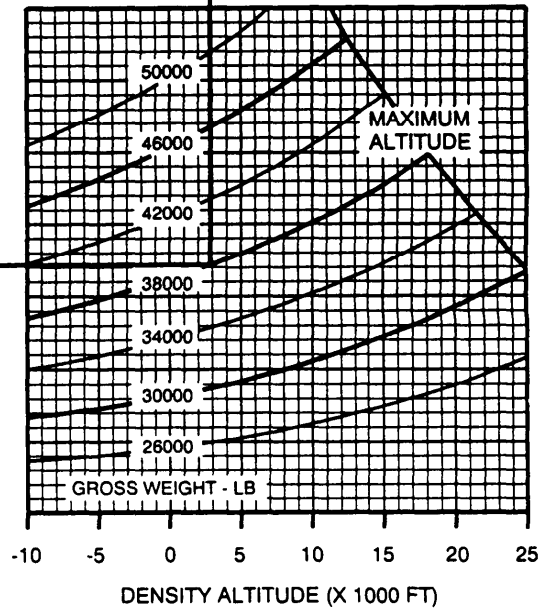
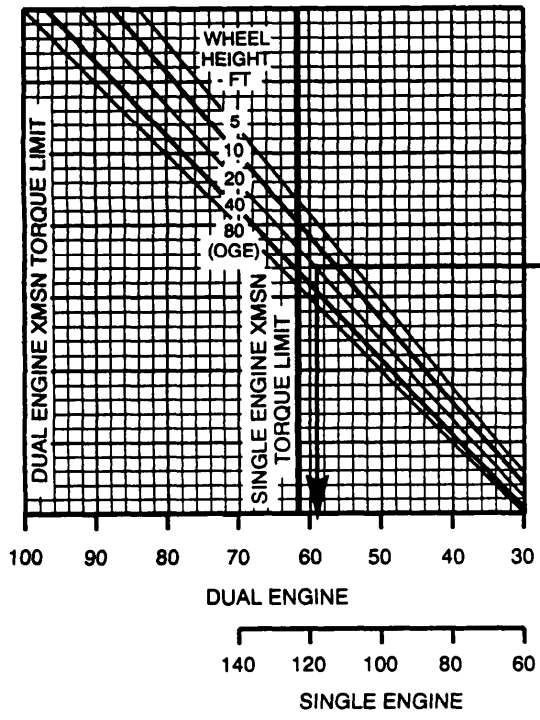
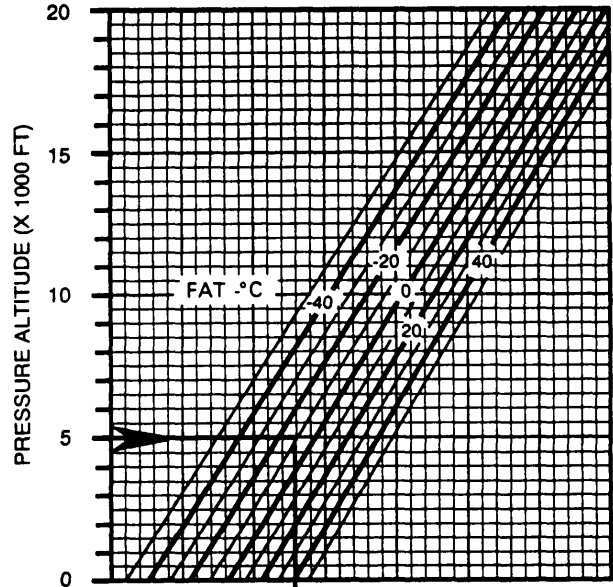
**WANTED**  
TORQUE REQUIRED TO HOVER

**KNOWN**  
PRESSURE ALTITUDE = 5000 FT/FAT = -10°C  
GROSS WEIGHT = 38000LB  
DESIRED WHEEL HEIGHT = 20 FT

**METHOD**  
ENTER PRESSURE ALTITUDE HERE  
MOVE DOWN TO FAT  
MOVE DOWN TO GROSS WEIGHT  
MOVE LEFT TO DESIRED WHEEL HEIGHT  
MOVE DOWN AND READ TORQUE REQ'D TO HOVER (PER ENGINE):  
59% (DUAL ENG OPERATION)  
118% (SINGLE ENG OPERATION)

**NOTE**  
WHEN OPERATING BELOW 0°C INCREASE TORQUE REQ'D PER ENG BY:

0°C	-20°C	-40°C	-50°C
0%	1%	2%	3%



TORQUE REQUIRED PER ENGINE (PERCENT)

DATA BASIS: FLIGHT TEST

A7886

Figure 7-6. Hover Chart

## MAXIMUM GROSS WEIGHT TO HOVER MAXIMUM POWER (10 MINUTES)

**HOVER  
CH-47D  
(2) T55-L-712**

**100% ROTOR RPM**

**TAS=0 KN**

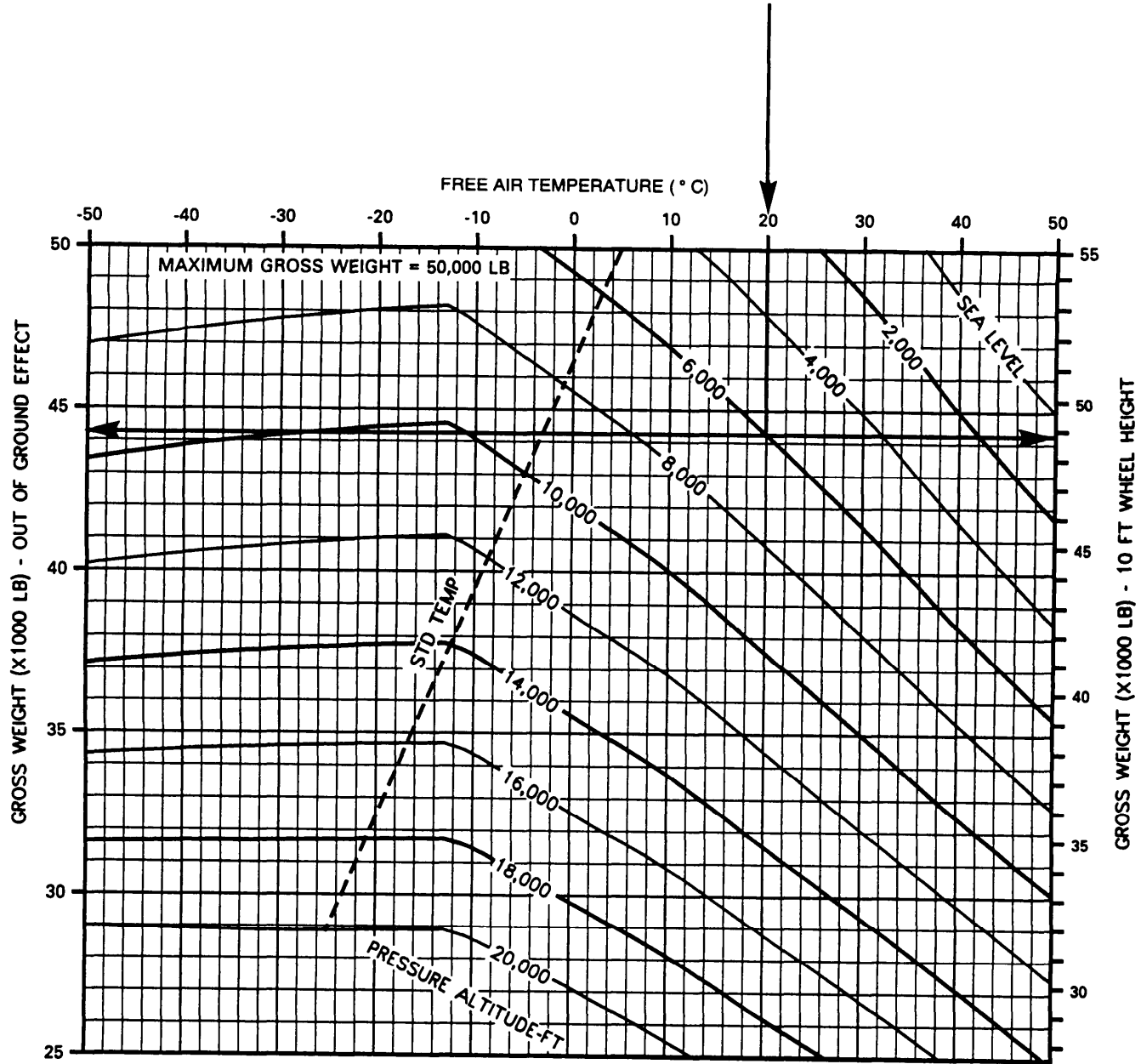
**EXAMPLE**

**METHOD**

**WANTED**  
MAXIMUM GROSS WEIGHT TO HOVER

ENTER FAT AT 20°C MOVE RIGHT TO PRESSURE ALTITUDE = 6000 FT  
MOVE LEFT - READ MAX GROSS WEIGHT TO HOVER OUT OF  
GROUND EFFECT = 44300 LB  
OR  
MOVE RIGHT - READ MAX GROSS WEIGHT TO HOVER AT 10 FT  
WHEEL HEIGHT = 48800 LB

**KNOWN**  
PRESSURE ALTITUDE = 6000 FT/FAT = 20°C



DATA BASIS: FLIGHT TEST

A9731

Figure 7-7. Hover Ceiling



## SECTION VI TAKEOFF

### 7-25. Description.

The takeoff chart, figure 7-8, defines distances required to clear obstacles of **50 feet**, **100 feet**, **150 feet**, and **200 feet** based upon maximum hover height capability and true airspeed. The procedure for takeoff is the level flight acceleration technique.

#### NOTE

The maximum hover heights shown are indicative of helicopter performance capability and do not imply that this hover height must be maintained through takeoff.

### 7-26. Use of Chart.

The primary use of the chart is illustrated by the examples.

a. To determine the distance required to clear an obstacle, it is necessary to know maximum hover height (hover capability), obstacle height, and climbout true airspeed. Calculation of maximum hover height is described in Section V, Hover. Enter the chart for the

required obstacle height, move right to desired true climbout airspeed, then down and read distance required to clear obstacle.

b. A hover check should be made prior to takeoff to verify hover capability. If winds are present, hover capability will be greater than predicted since the hover chart is based on calm wind conditions.

### 7-27. Conditions.

a. The takeoff chart is based on calm wind conditions. Since the surface wind velocity and direction cannot be accurately predicted, all takeoff planning should be based on calm air conditions. Takeoff into the wind will improve takeoff performance.

#### **CAUTION**

**A tailwind during takeoff and climbout will increase the distance for obstacle clearance and may prevent a successful takeoff.**

b. Takeoff performance data are based on the use of maximum torque available at 100% RRPM.

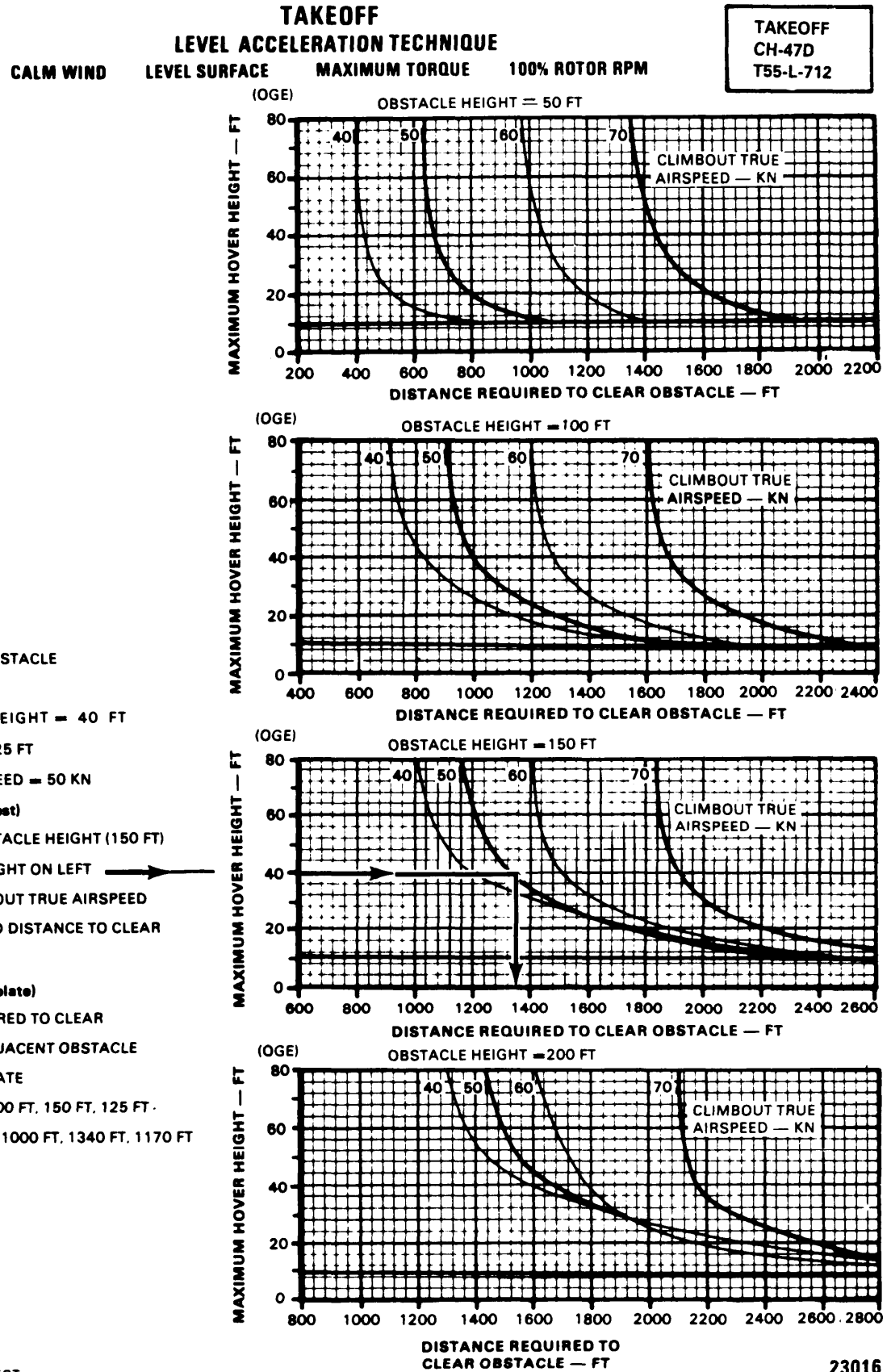


Figure 7-8. Takeoff Chart

## SECTION VII CRUISE

## 7-28. Description.

The cruise charts, figures 7-9 through 7-92, present torque requirements and fuel flow for cruise flight as a function of airspeed and gross weight for various combinations of pressure altitude and free air temperature. Dot pattern (shaded) area indicates time limited operation.

## 7-29. Use of Charts.

The primary use of charts is illustrated by the example cruise chart (fig. 7-9). To use the charts it is usually necessary to know the planned PA, estimated FAT, planned cruise TAS, and the GW. First, select the proper chart based on PA and free air temperature. Enter the chart at the cruise TAS, move right and read IAS, move left to the GW, move down and read torque required, then move up and read associated fuel flow. Maximum performance conditions are determined by entering the chart where the maximum range line or maximum endurance and rate of climb (R/C) line intersect the gross weight line; then read airspeed, fuel flow, and torque required. Normally, sufficient accuracy can be obtained by selecting the chart nearest to the planned cruising altitude and FAT, or move conservatively, by selecting the chart with the next higher altitude and FAT (example cruise chart, method one). If greater accuracy is required, interpolation between altitudes and/or temperatures is permissible (example cruise chart, method two). To be conservative, use the GW at the beginning of the cruise flight. For improved accuracy or long flights, it is preferable to determine cruise information for several flight segments to allow for decreasing GW.

a. *Airspeed.* True and indicated airspeeds are presented at opposite sides of each chart. On any chart, IAS can be directly converted to TAS (or vice versa) by reading directly across the chart without regard to other chart information. Estimated airspeed limits with an **operating** CGI appear as dashed lines on each chart. Airspeed limits with the CGI **inoperative** are presented in the airspeed limits section of Chapter 5.

## NOTE

Airspeed limitations with an operative cruise guide indicator are per the indicator display. Estimated values shown on these cruise charts are for information only, as an aid to pre-flight planning.

b. *Torque.* Since PA and temperature are defined for each chart, torque required varies only with GW and airspeed. The torque required per engine as presented on the charts is for dual engine operation. The torque required for single engine operation is double the dual engine torque value for any given condition. See cruise chart example 2 for example on torque required. The torque available limits shown are either transmission or engine torque limits (whichever is least).

c. *Fuel Flow.* The fuel flow scales presented on each chart opposite the torque scales are for dual engine operation. Torque may be converted directly to fuel flow on any chart without regard to other chart information. A single engine fuel flow chart is presented in Section X. Torque required for any given condition as obtained from the preceding cruise charts should be doubled before being used to obtain single engine fuel flow from this chart.

d. *Maximum Range.* Maximum range lines indicate optimum GW/cruise speed conditions with respect to distance covered per-pound of fuel consumed for zero wind condition.

e. *Maximum Endurance and Rate of Climb.* Maximum endurance and rate of climb lines indicate optimum GW/cruise speed conditions for maximum endurance and maximum rate of climb. These conditions require minimum fuel flow (maximum endurance) and provide maximum torque change for climb (maximum rate of climb).

## 7-30. Conditions.

The cruise charts are based on 100% RRPM for ambient temperatures of  $-10^{\circ}\text{C}$  and above, and 98% and 100% RRPM for ambient temperatures of  $-20^{\circ}\text{C}$  and below.

## CRUISE EXAMPLE

### EXAMPLE 1 (DUAL ENGINE)

WANTED:

SPEED FOR MAXIMUM ENDURANCE  
 SPEED FOR MAXIMUM RANGE  
 MAX. SPEED AT CONTINUOUS TORQUE RATING  
 ESTIMATED AIRSPEED LIMIT WITH CRUISE  
 GUIDE INDICATOR OPERATIVE

KNOWN:

GROSS WEIGHT = 50,000 LB.  
 PRESSURE ALTITUDE = SEA LEVEL  
 FAT = 30°C

METHOD:

READ SPEEDS WHERE GROSS WEIGHT LINE  
 INTERSECTS PERFORMANCE OR LIMIT LINE  
 MAXIMUM ENDURANCE: TAS = 89 KN, IAS = 83  
 MAXIMUM RANGE: TAS = 144 KN, IAS = 140 KN  
 (REQUIRES POWER IN EXCESS OF MAX CONTIN-  
 UOUS POWER)  
 MAX SPEED (CONTINUOUS TORQUE RATING):  
 TAS = 130 KN, IAS = 127 KN  
 ESTIMATED AIRSPEED LIMIT (VCGI): 152 KN  
 IAS = 148 KN

### EXAMPLE 2 (DUAL ENGINE (DASH LINE)

WANTED:

TORQUE REQUIRED FOR LEVEL FLIGHT, FUEL  
 FLOW, AND INDICATED AIRSPEED AT TAS = 120 KN

KNOWN :

GROSS WEIGHT = 45,000 LB  
 PRESSURE ALTITUDE = SEA LEVEL  
 FAT = 35°C  
 TRUE AIRSPEED = 120 KN

METHOD 1 (SIMPLEST)

USE NEXT HIGHER TEMPERATURE (40°C)  
 ENTER TAS, MOVE RIGHT TO GROSS WEIGHT  
 MOVE DOWN READ TORQUE REQ'D = 55%  
 (PER ENGINE)  
 MOVE UP READ FUEL FLOW = 2670 LB/HR  
 (TOTAL)  
 MOVE RIGHT READ IAS = 114 KN

METHOD 2 (INTERPOLATE)

READ TORQUE REQ'D, FUEL FLOW, AND IAS AT  
 EACH ADJACENT TEMPERATURE THEN INTER-  
 POLATE BETWEEN TEMPERATURES

(REFER TO TABLE BELOW)

PRESSURE ALTITUDE	SEA LEVEL	SEA LEVEL	SEA LEVEL
FAT	30°C	40°C	35°C
TORQUE REQ'D (%)	54.7%	55%	54.9%
FUEL FLOW (LB/HR)	2620	2670	2645
IAS (KNOTS)	117	114	115.5

Figure 7-9. Example Cruise Chart (Sheet 1 of 2)



**CRUISE**

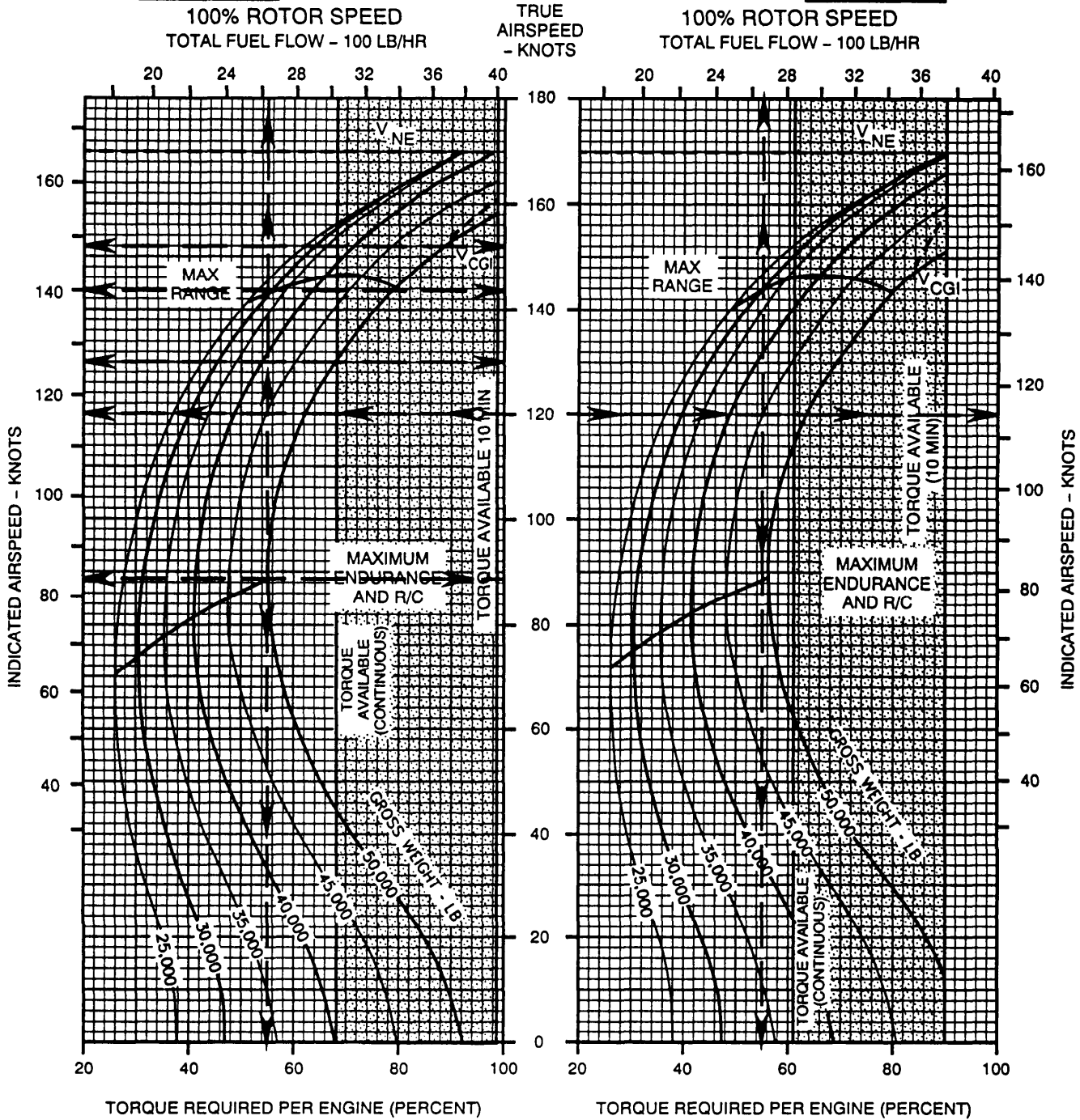
**PRESSURE ALTITUDE - SEA LEVEL**

**CRUISE  
CH-47D  
(2) T55-L-712**

**CLEAN CONFIGURATION JP-4 FUEL**

**FAT=30°C**

**FAT=40°C**



DATA BASIS: FLIGHT TEST

A21184

Figure 7-9. Example Cruise Chart (Sheet 2 of 2)

# CRUISE

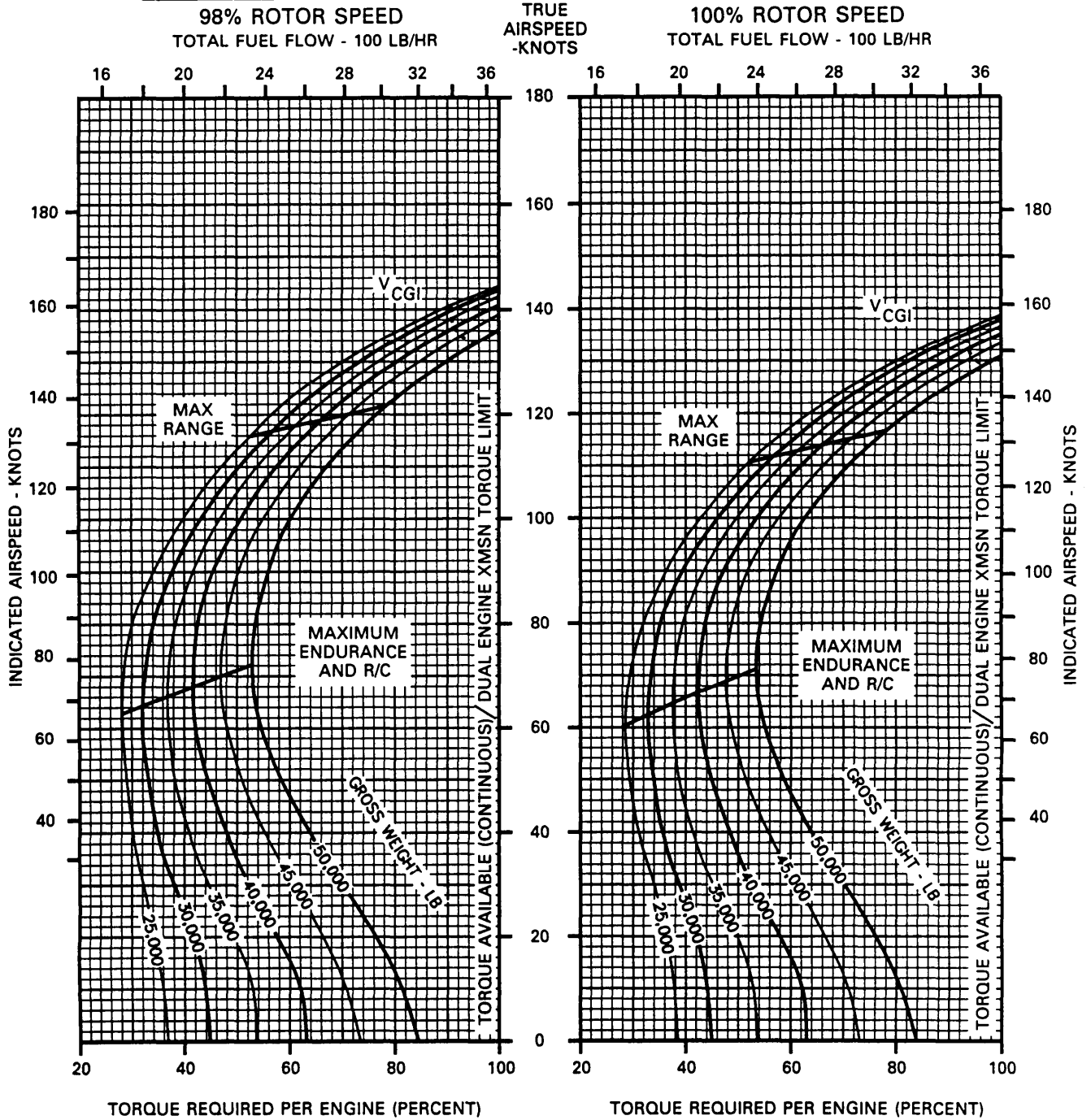
PRESSURE ALTITUDE - SEA LEVEL

CRUISE  
CH-47D  
(2) T55-L-712

CLEAN CONFIGURATION JP-4 FUEL

FAT=-50 °C

FAT=-50 °C



DATA BASIS: FLIGHT TEST

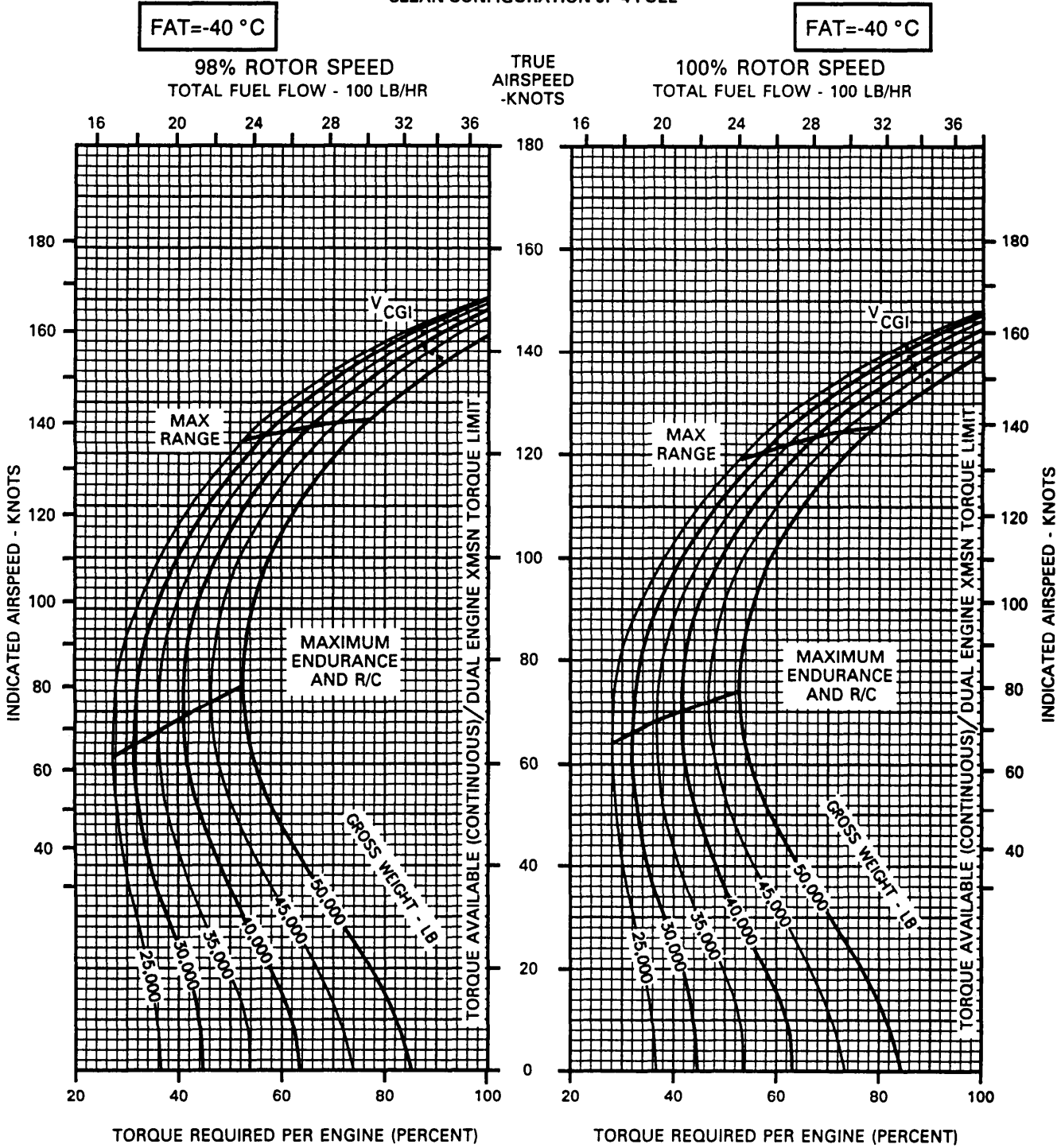
A9143

Figure 7-10. 98 and 100% Rotor RPM, -50°C, Sea Level

**CRUISE**  
PRESSURE ALTITUDE - SEA LEVEL

**CRUISE**  
CH-47D  
(2) T55-L-712

CLEAN CONFIGURATION JP-4 FUEL



DATA BASIS: FLIGHT TEST

A9144

Figure 7-11. 98 and 100% Rotor RPM, -40°C, Sea Level

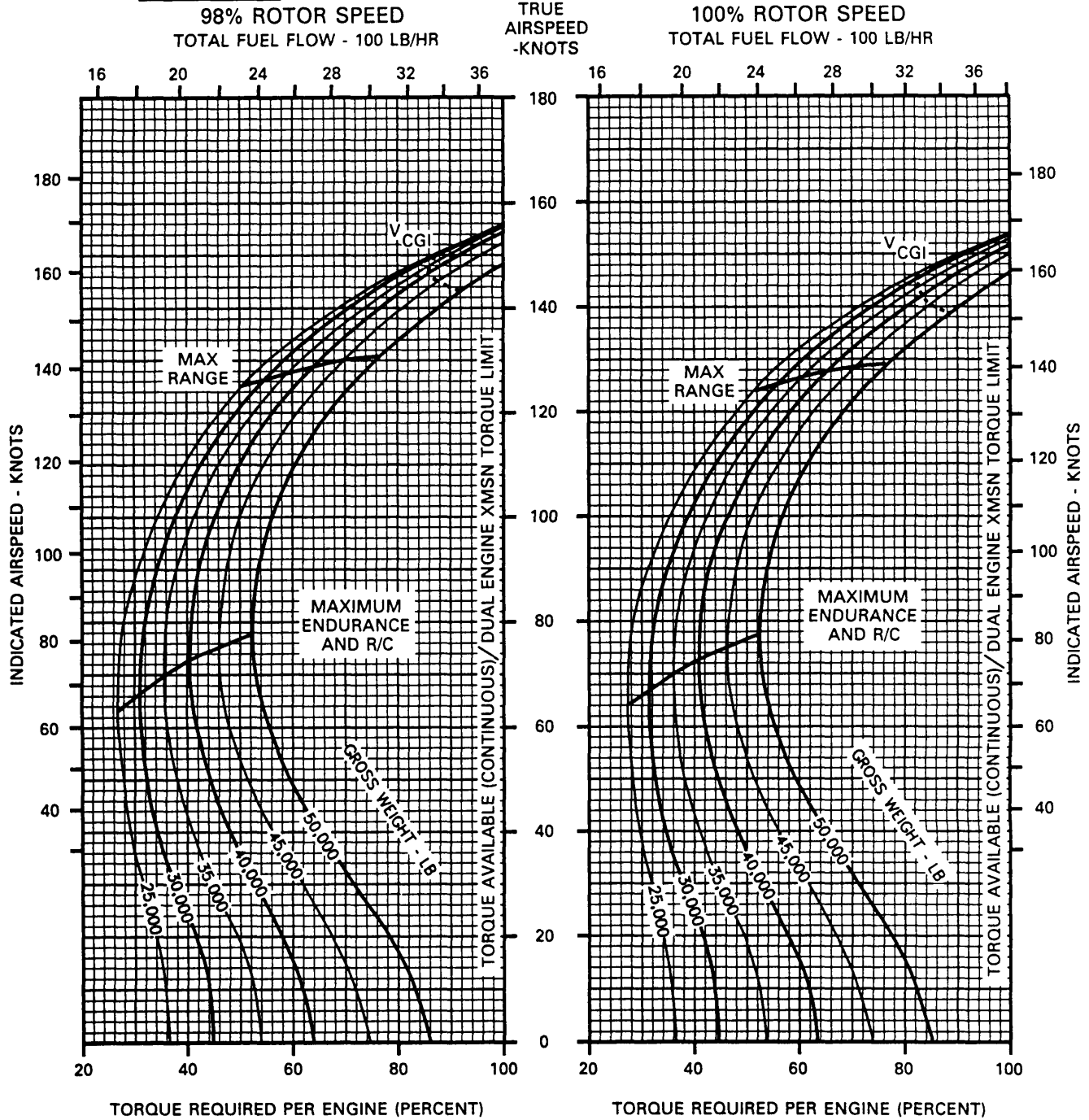
**CRUISE**  
**PRESSURE ALTITUDE - SEA LEVEL**

**CRUISE**  
**CH-47D**  
**(2) T55-L-712**

CLEAN CONFIGURATION JP-4 FUEL

**FAT=-30 °C**

**FAT=-30 °C**



DATA BASIS: FLIGHT TEST

A9145

Figure 7-12. 98 and 100% Rotor RPM, -30°C, Sea Level

**CRUISE**

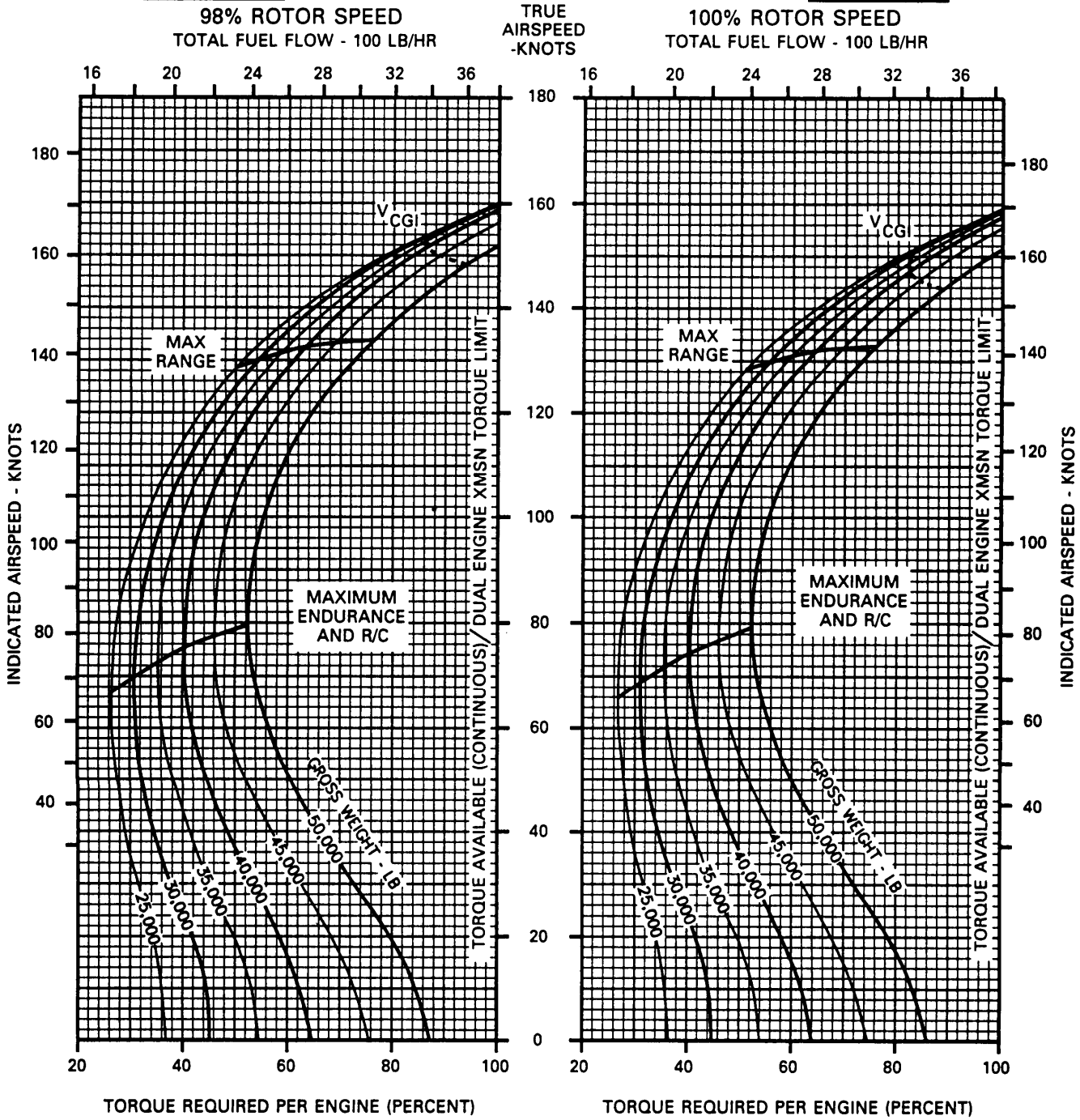
**PRESSURE ALTITUDE - SEA LEVEL**

**CRUISE  
CH-47D  
(2) T55-L-712**

**CLEAN CONFIGURATION JP-4 FUEL**

**FAT=-20 °C**

**FAT=-20 °C**



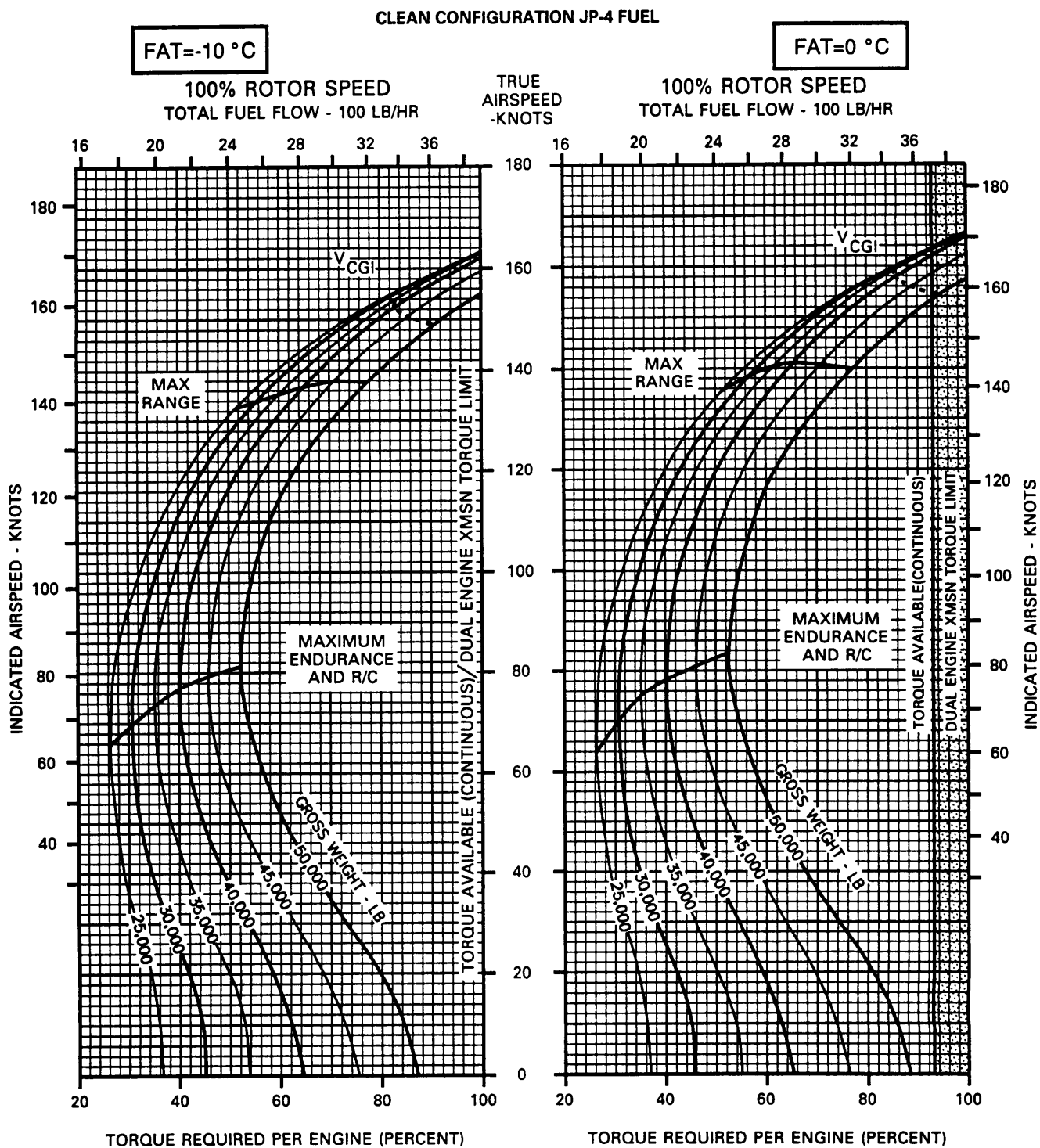
**DATA BASIS: FLIGHT TEST**

**A21185**

*Figure 7-13. 98 and 100% Rotor RPM, -20°C, Sea Level*

**CRUISE**  
**PRESSURE ALTITUDE - SEA LEVEL**

**CRUISE**  
**CH-47D**  
**(2) T55-L-712**



DATA BASIS: FLIGHT TEST

A21186

Figure 7-14. 100% Rotor RPM., -10° and 0°C, Sea Level

# CRUISE

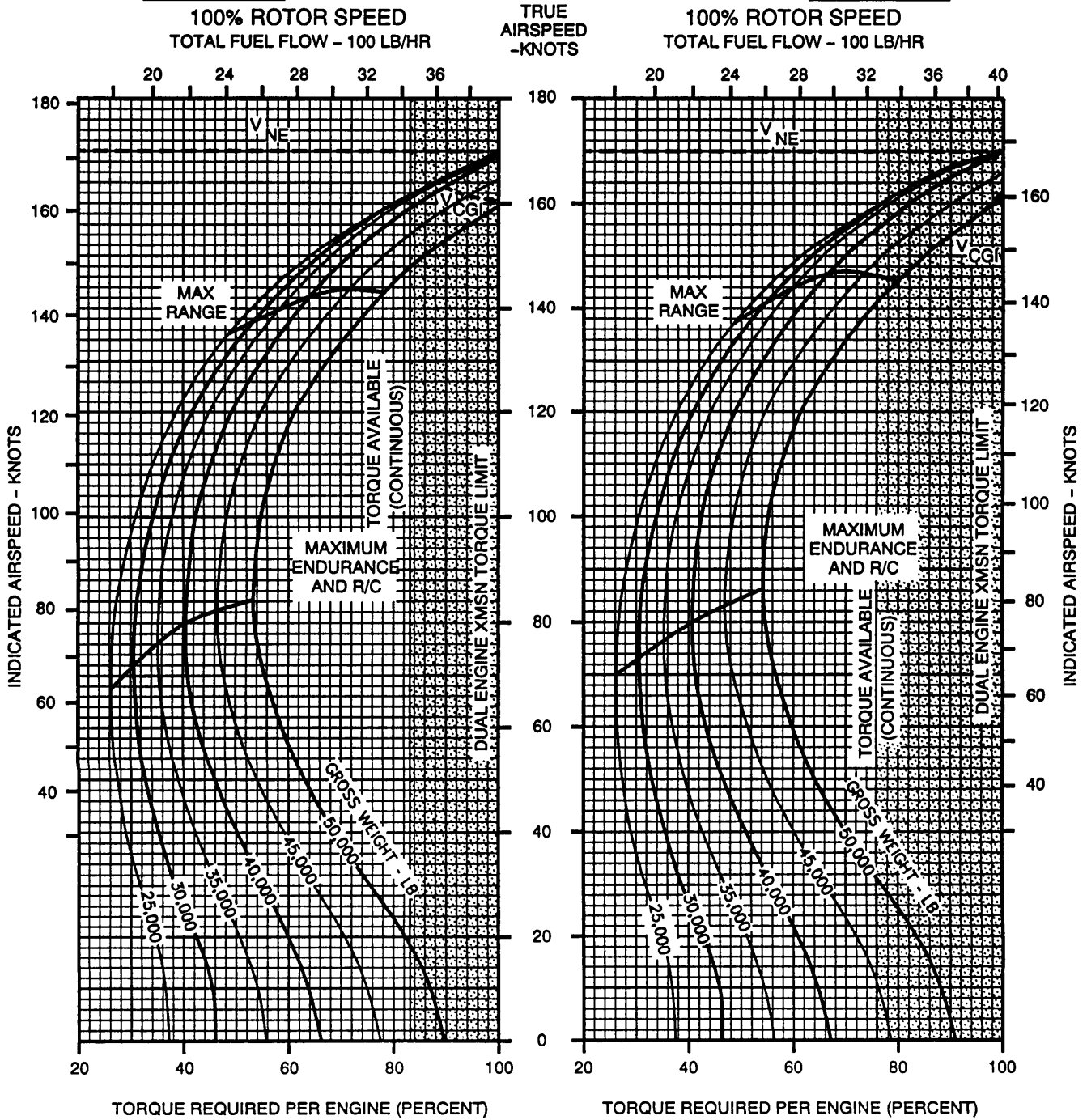
PRESSURE ALTITUDE - SEA LEVEL

CRUISE  
CH-47D  
(2) T55-L-712

CLEAN CONFIGURATION JP-4 FUEL

FAT=10°C

FAT=20°C



DATA BASIS: FLIGHT TEST

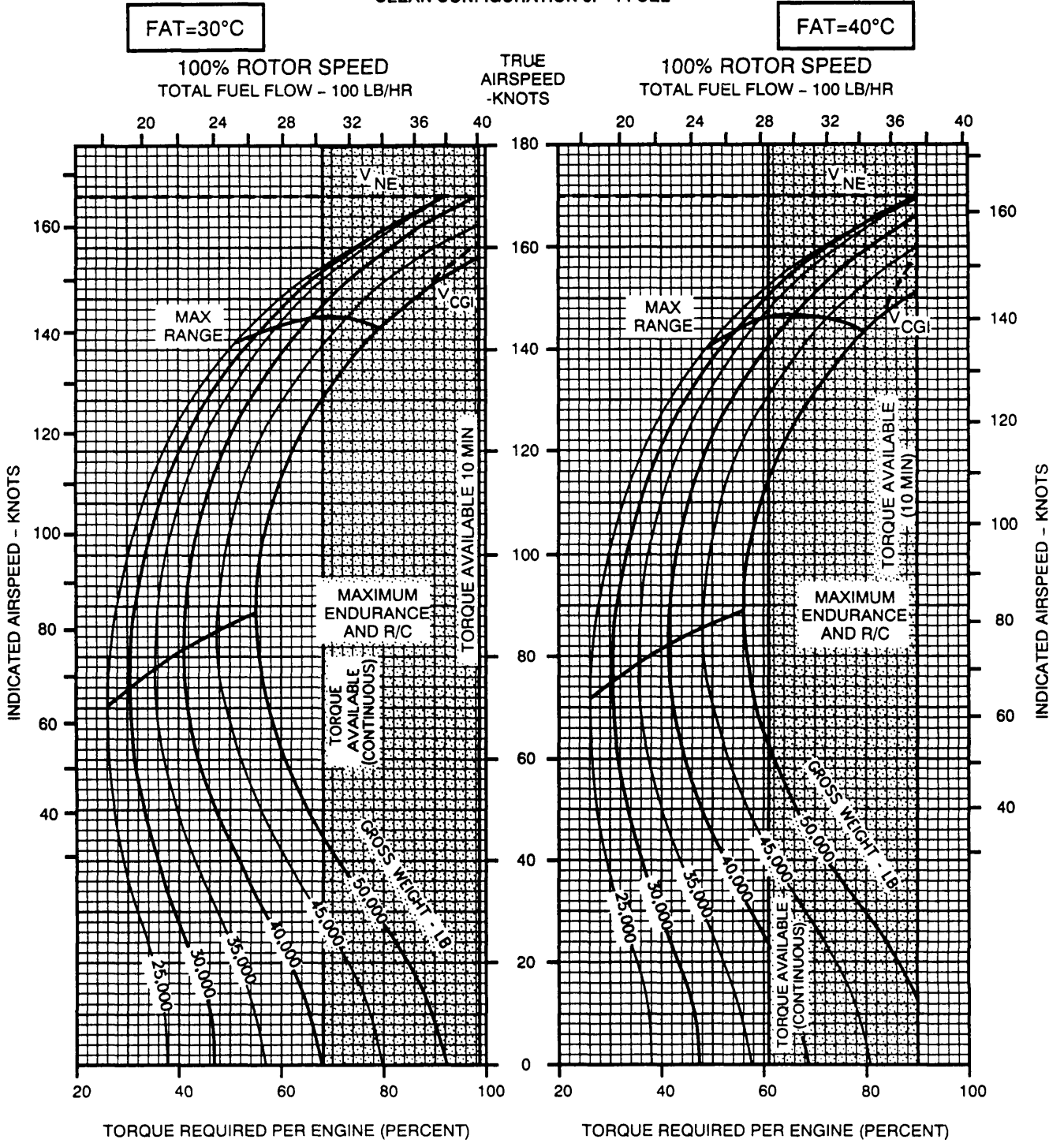
A21187

Figure 7-15. 100% Rotor RPM, 10° and 20°C, Sea Level

**CRUISE**  
**PRESSURE ALTITUDE - SEA LEVEL**

**CRUISE**  
**CH-47D**  
**(2) T55-L-712**

CLEAN CONFIGURATION JP-4 FUEL



DATA BASIS: FLIGHT TEST

A21188

Figure 7-16. 100% Rotor RPM, 30° and 40°C, Sea Level



# CRUISE

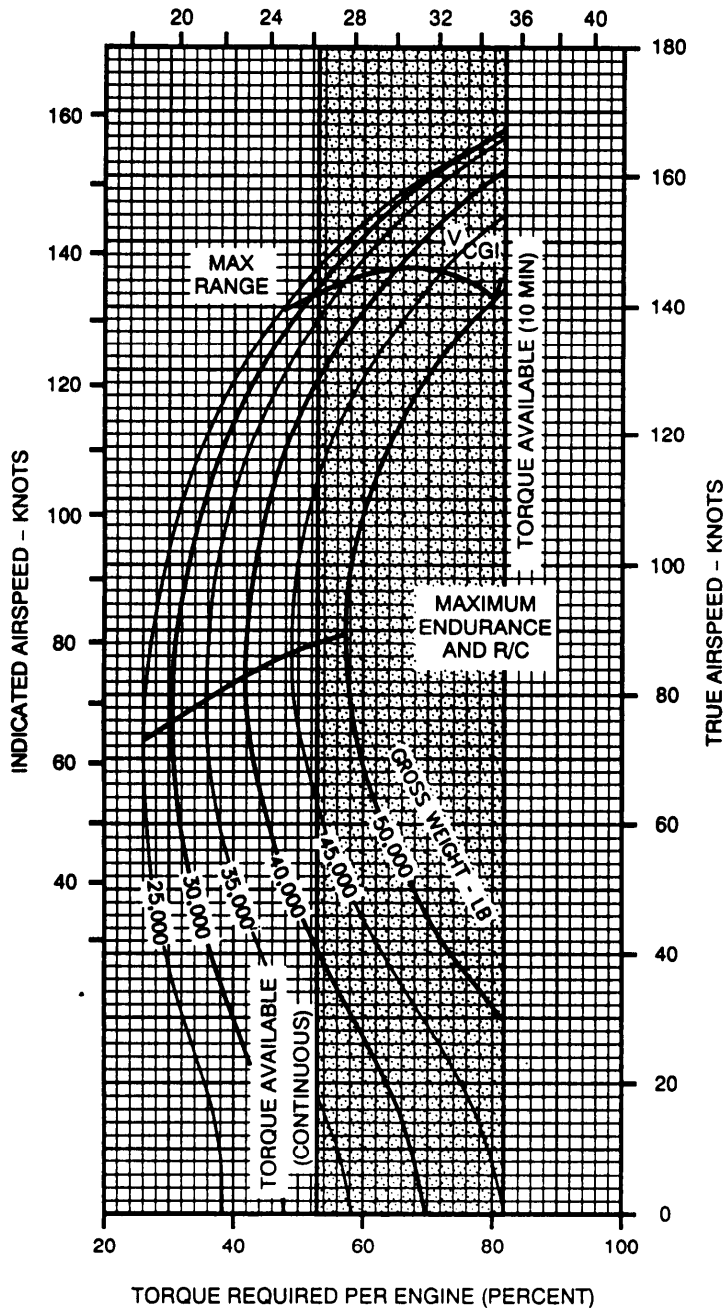
PRESSURE ALTITUDE - SEA LEVEL

CRUISE  
CH-47D  
(2) T55-L-712

CLEAN CONFIGURATION JP-4 FUEL

FAT=50°C

100% ROTOR SPEED  
TOTAL FUEL FLOW - 100 LB/HR



DATA BASIS: FLIGHT TEST

A9405

Figure 7-17. 100% Rotor RPM, 50°C, Sea Level

**CRUISE**

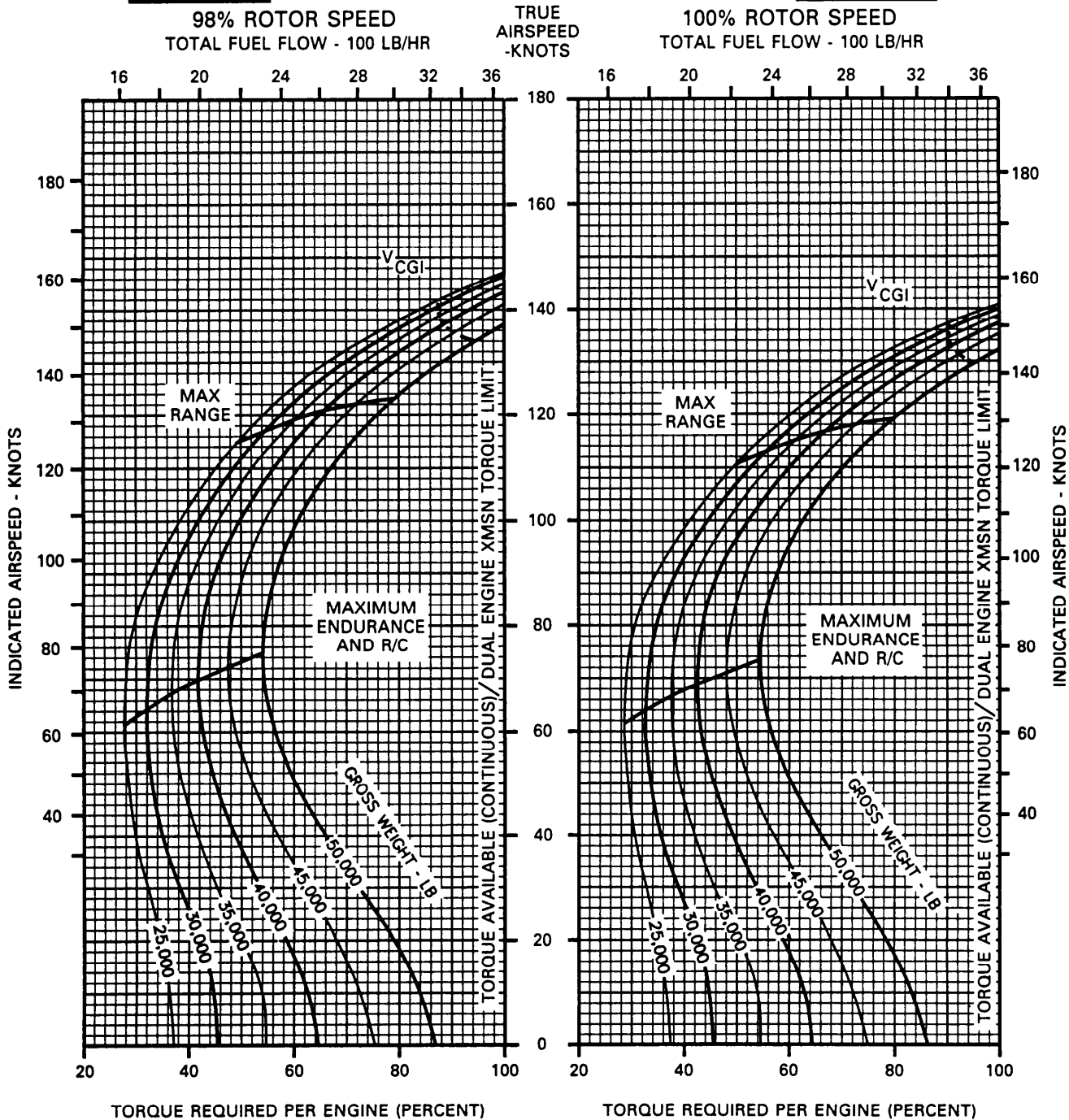
**PRESSURE ALTITUDE - 2000 FT**

**CRUISE  
CH-47D  
(2) T55-L-712**

**CLEAN CONFIGURATION JP-4 FUEL**

**FAT=-50 °C**

**FAT=-50 °C**



**DATA BASIS: FLIGHT TEST**

**A9146**

*Figure 7-18. 98 and 100% Rotor RPM, -50°C, 2,000 Feet*

**CRUISE**

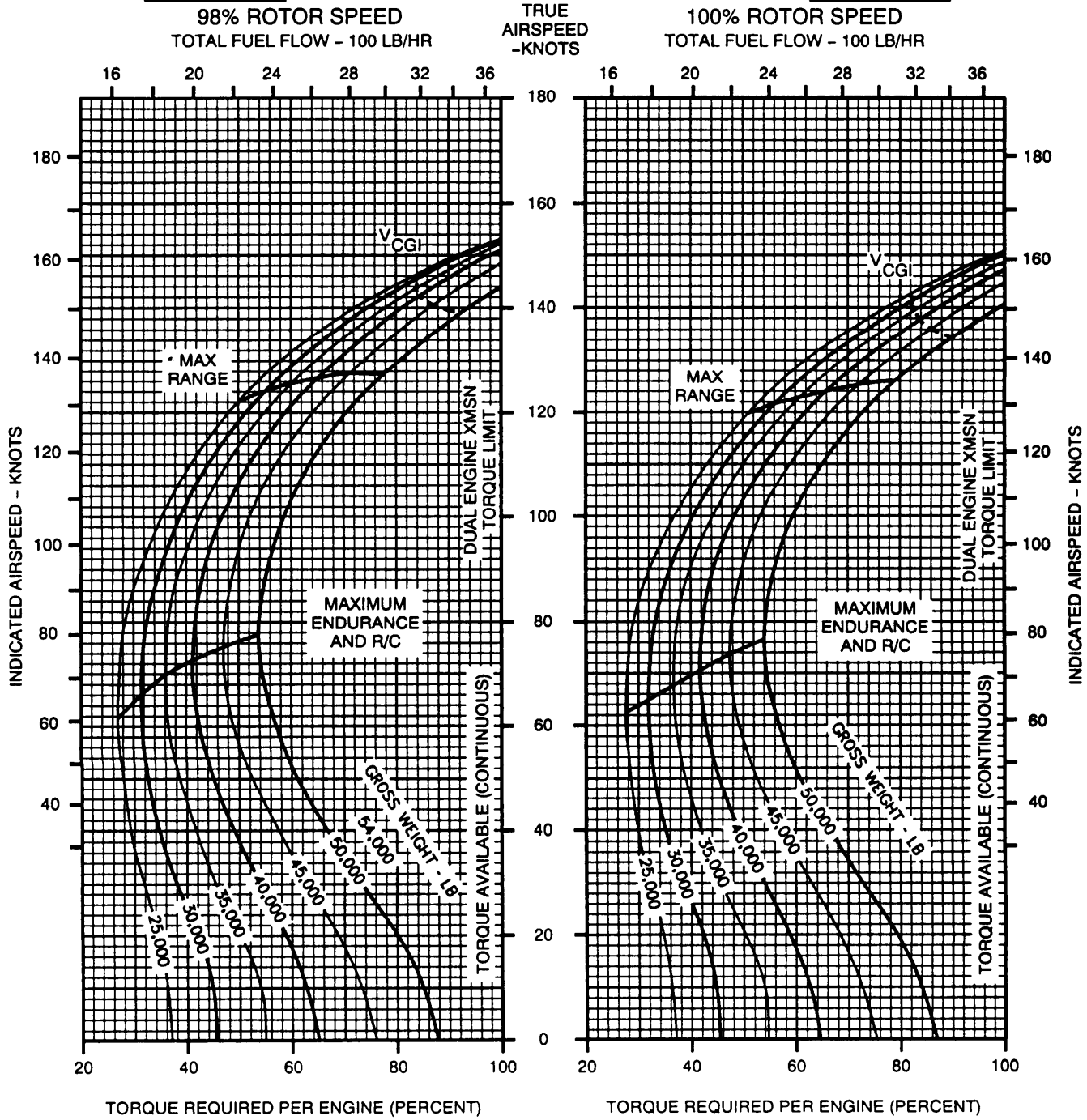
**PRESSURE ALTITUDE - 2000 FT**

**CRUISE  
CH-47D  
(2) T55-L-712**

**CLEAN CONFIGURATION JP-4 FUEL**

**FAT=-40 °C**

**FAT=-40 °C**



DATA BASIS: FLIGHT TEST

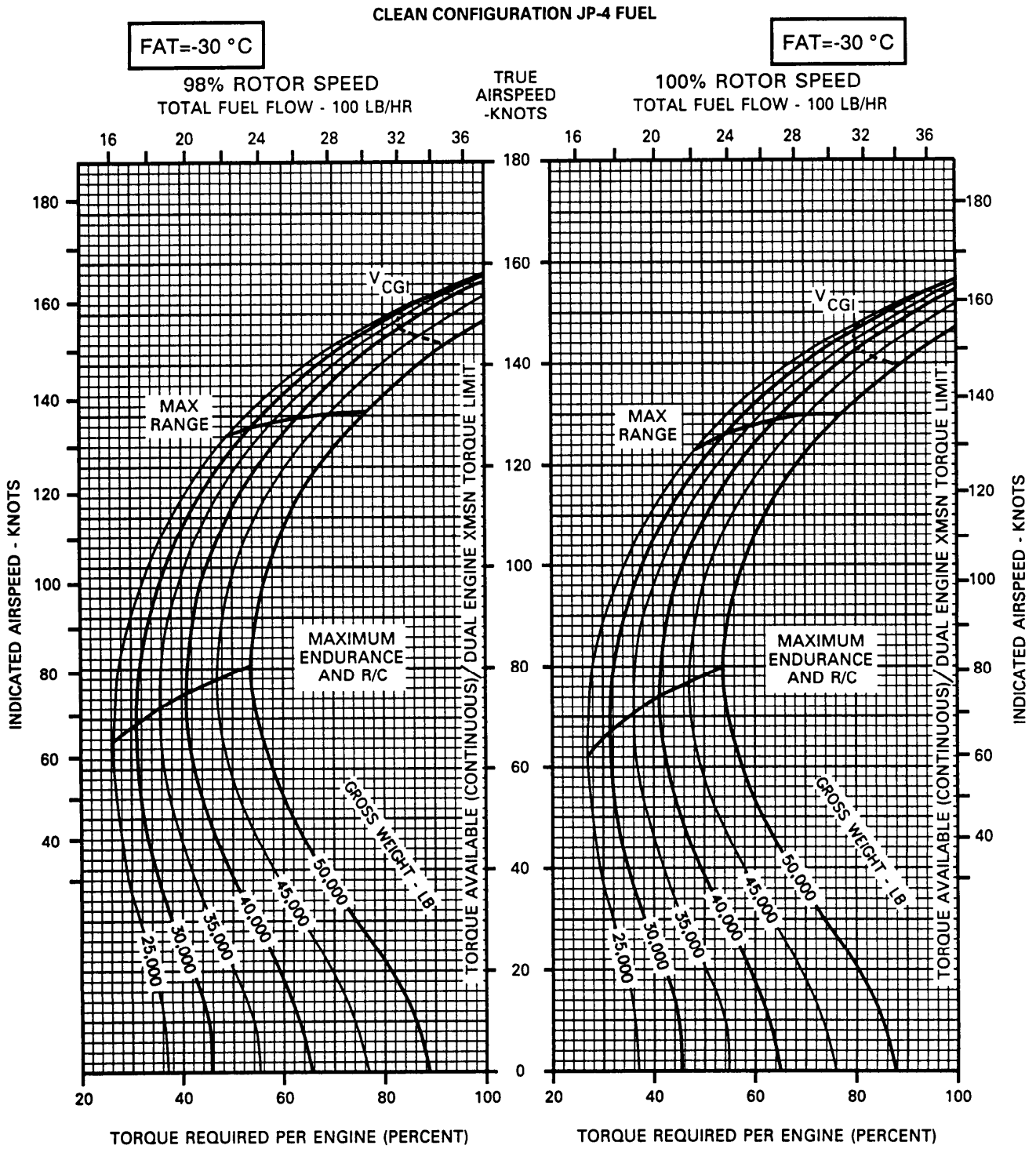
A9406

Figure 7-19. 98 and 100% Rotor RPM, -40°C, 2,000 Feet

# CRUISE

## PRESSURE ALTITUDE - 2000 FT

CRUISE  
CH-47D  
(2) T55-L-712



DATA BASIS: FLIGHT TEST

A9147

Figure 7-20. 98 and 100% Rotor RPM, -30°C, 2,000 Feet

**CRUISE**

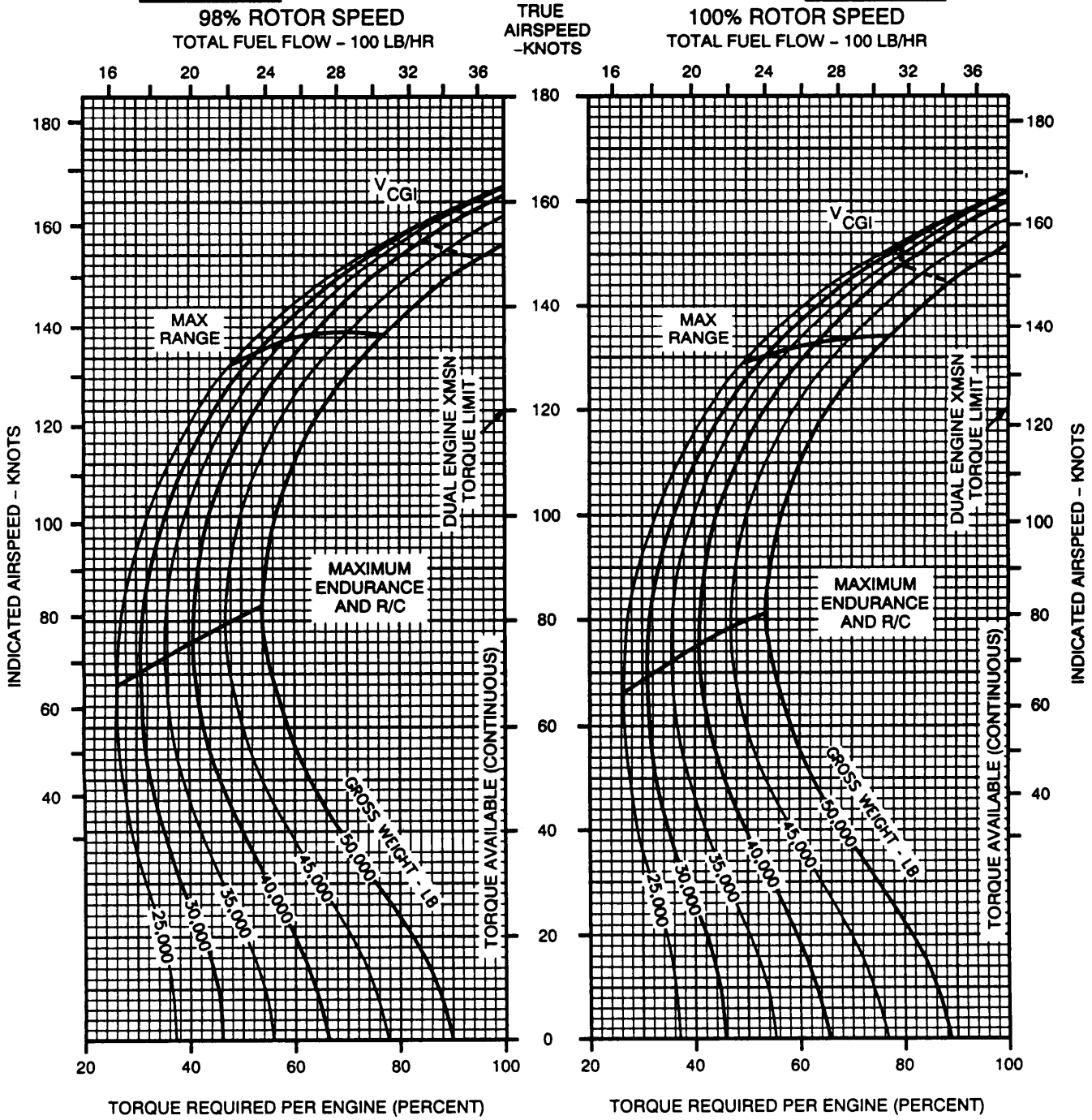
**PRESSURE ALTITUDE - 2000 FT**

**CRUISE  
CH-47D  
(2) T55-L-712**

**CLEAN CONFIGURATION JP-4 FUEL**

**FAT=-20 °C**

**FAT=-20 °C**



DATA BASIS: FLIGHT TEST

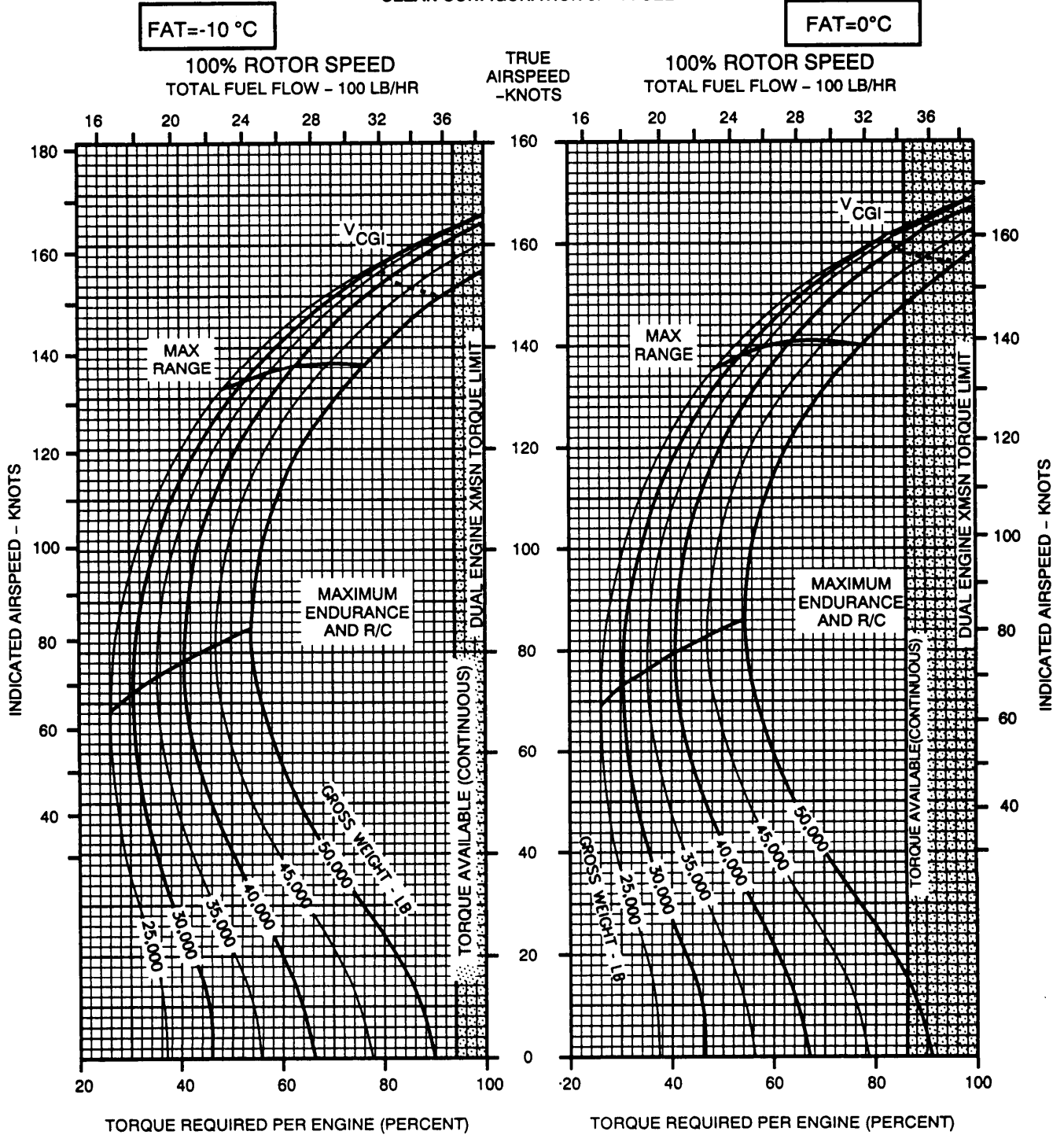
A21189

Figure 7-21. 98 and 100% Rotor RPM, -20°C, 2,000 Feet

**CRUISE**  
**PRESSURE ALTITUDE - 2000 FT**

**CRUISE**  
**CH-47D**  
**(2) T55-L-712**

CLEAN CONFIGURATION JP-4 FUEL



DATA BASIS: FLIGHT TEST

A21190

Figure 7-22. 100% Rotor RPM., -10° and 0°C, 2,000 Feet

**CRUISE**

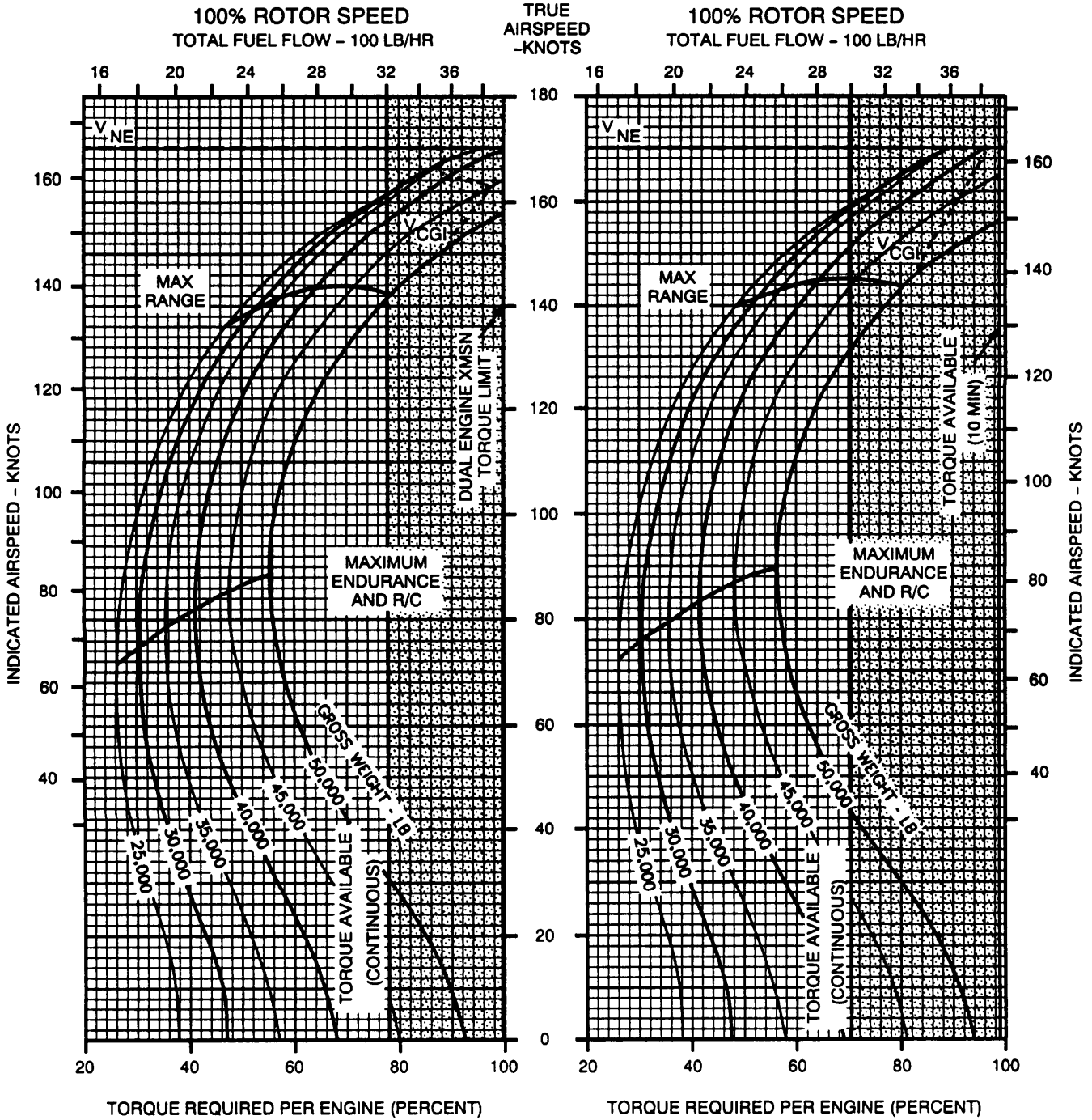
**PRESSURE ALTITUDE - 2000 FT**

**CRUISE  
CH-47D  
(2) T55-L-712**

**CLEAN CONFIGURATION JP-4 FUEL**

**FAT=10°C**

**FAT=20°C**



**DATA BASIS: FLIGHT TEST**

**A21181**

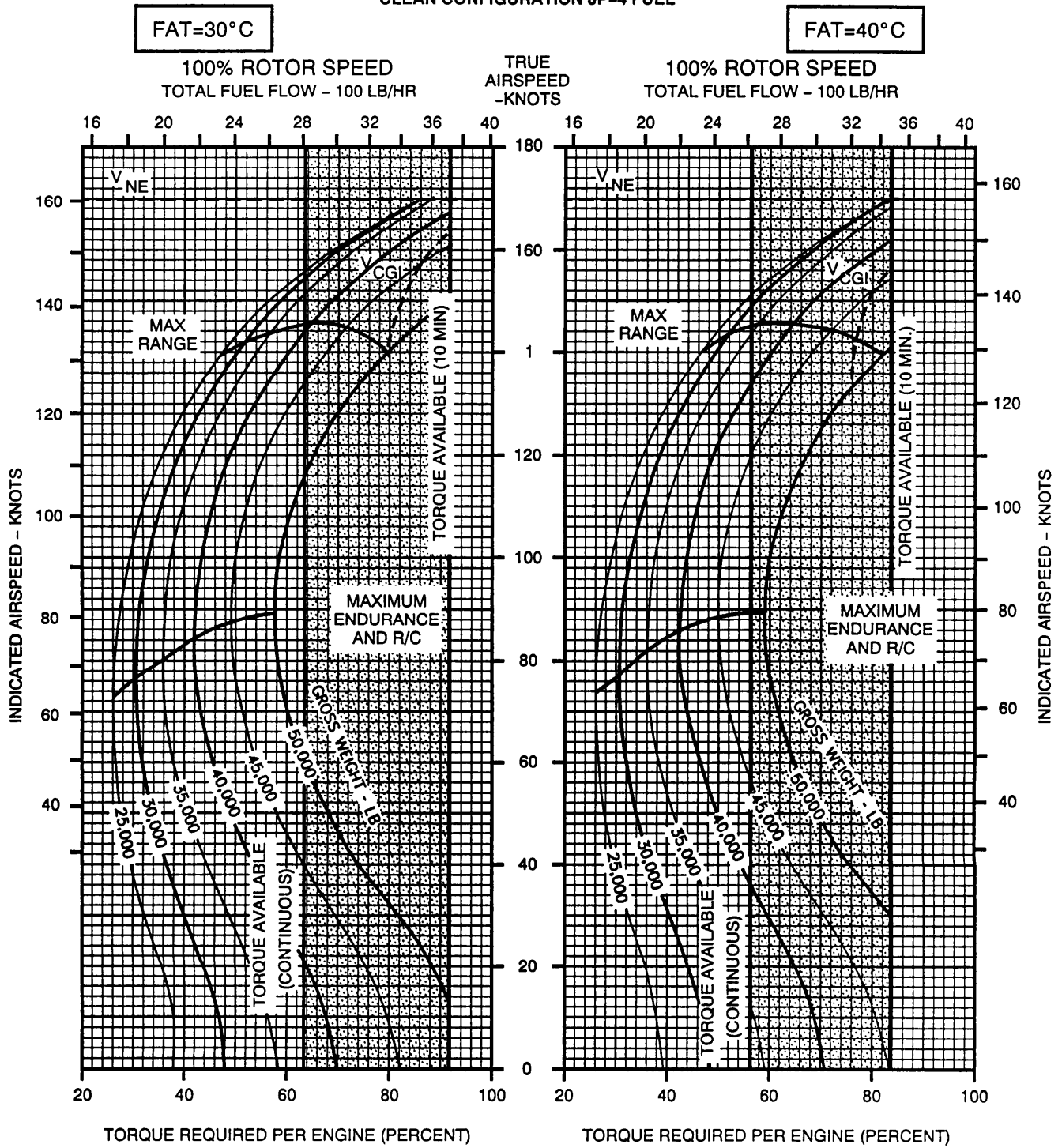
*Figure 7-23. 100% Rotor RPM, 10° and 20°C, 2,000 Feet*

**CRUISE**

**PRESSURE ALTITUDE - 2000 FT**

**CRUISE  
CH-47D  
(2) T55-L-712**

**CLEAN CONFIGURATION JP-4 FUEL**



**DATA BASIS:** FLIGHT TEST

A21259

**Figure 7-24. 100% Rotor RPM, 30° and 40°C, 2,000 Feet**

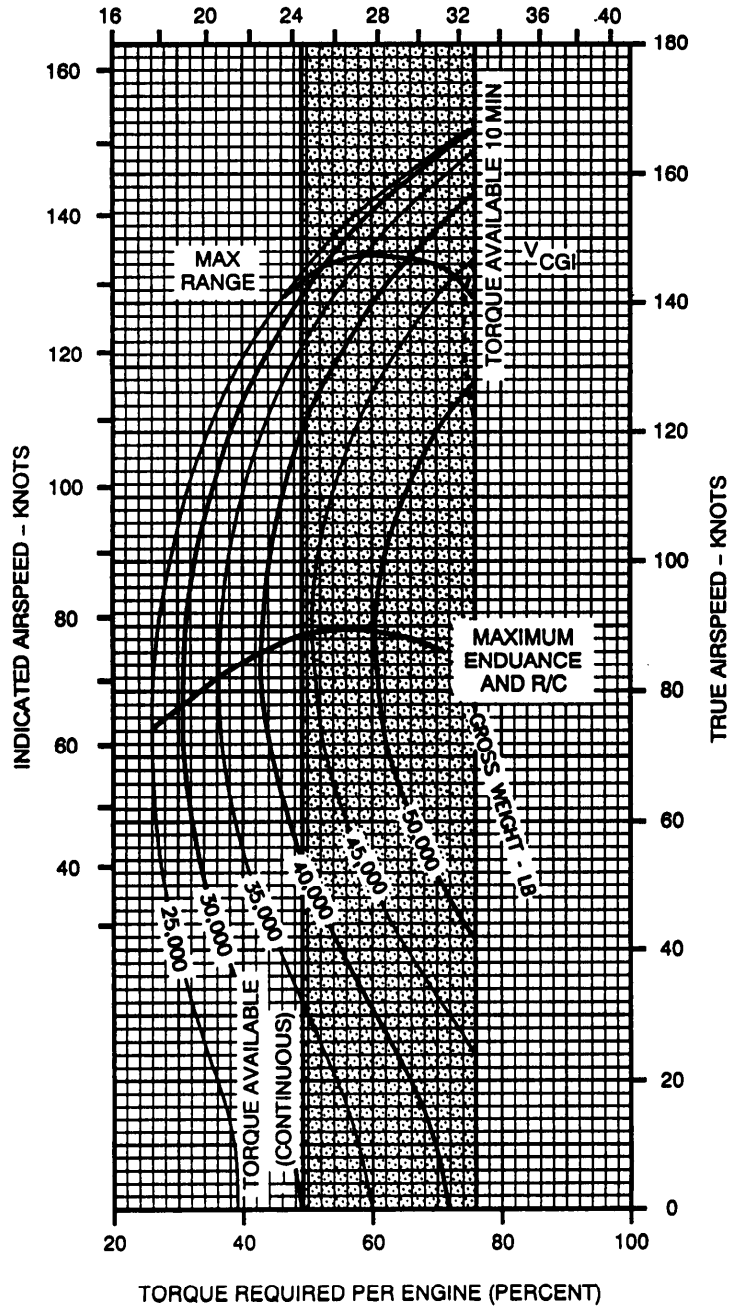


**CRUISE**  
**PRESSURE ALTITUDE - 2000 FT**  
**CLEAN CONFIGURATION JP-4 FUEL**

**CRUISE**  
**CH-47D**  
**(2) T55-L-712**

**FAT=50°C**

**100% ROTOR SPEED**  
**TOTAL FUEL FLOW - 100 LB/HR**



DATA BASIS: FLIGHT TEST

A9148

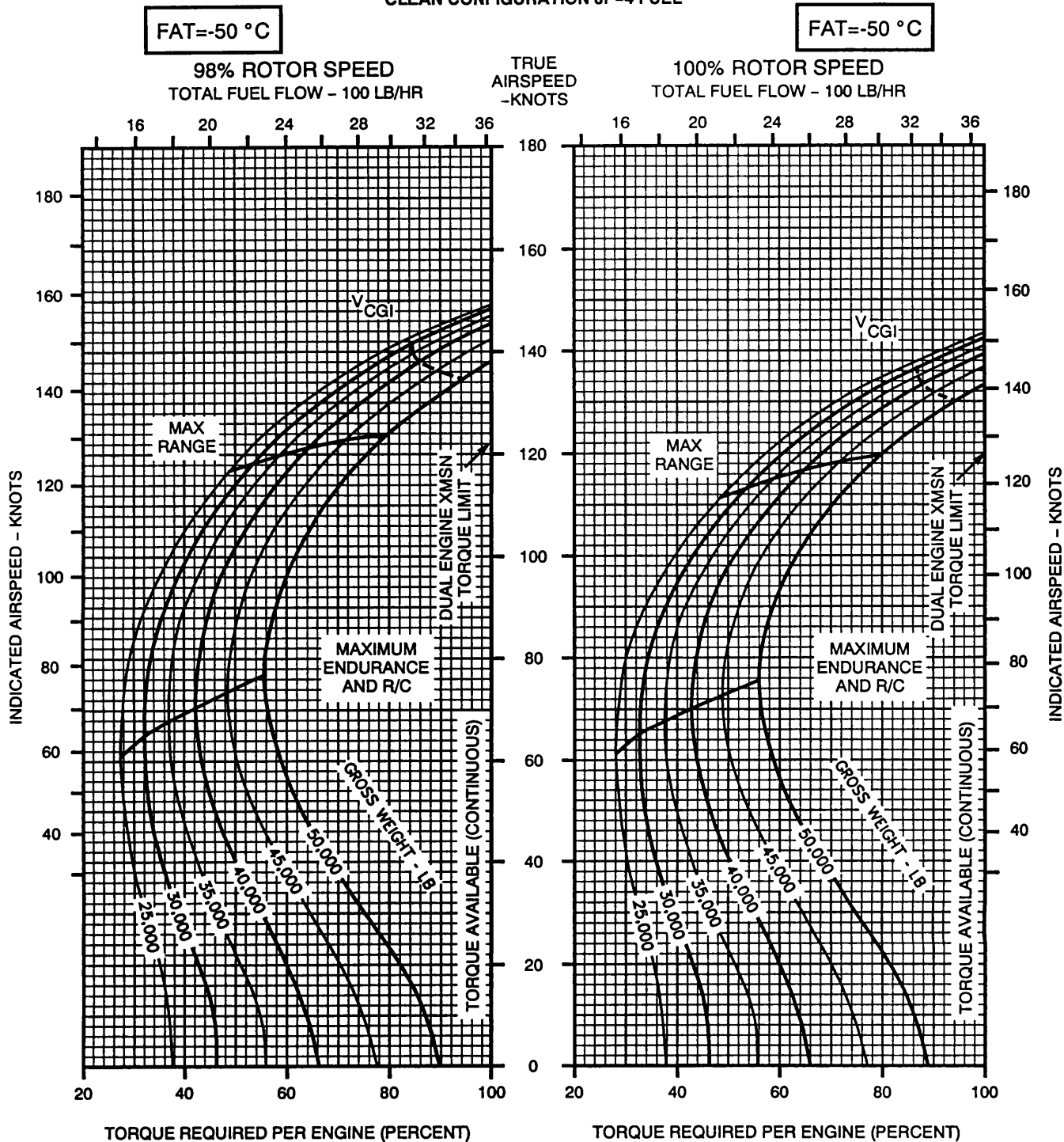
Figure 7-25. 100% Rotor RPM, 50°C, 2,000 Feet

# CRUISE

## PRESSURE ALTITUDE - 4000 FT

CRUISE  
CH-47D  
(2) T55-L-712

CLEAN CONFIGURATION JP-4 FUEL



DATA BASIS: FLIGHT TEST

A9125

Figure 7-26. 98 and 100% Rotor RPM, -50°C, 4,000 Feet

**CRUISE**

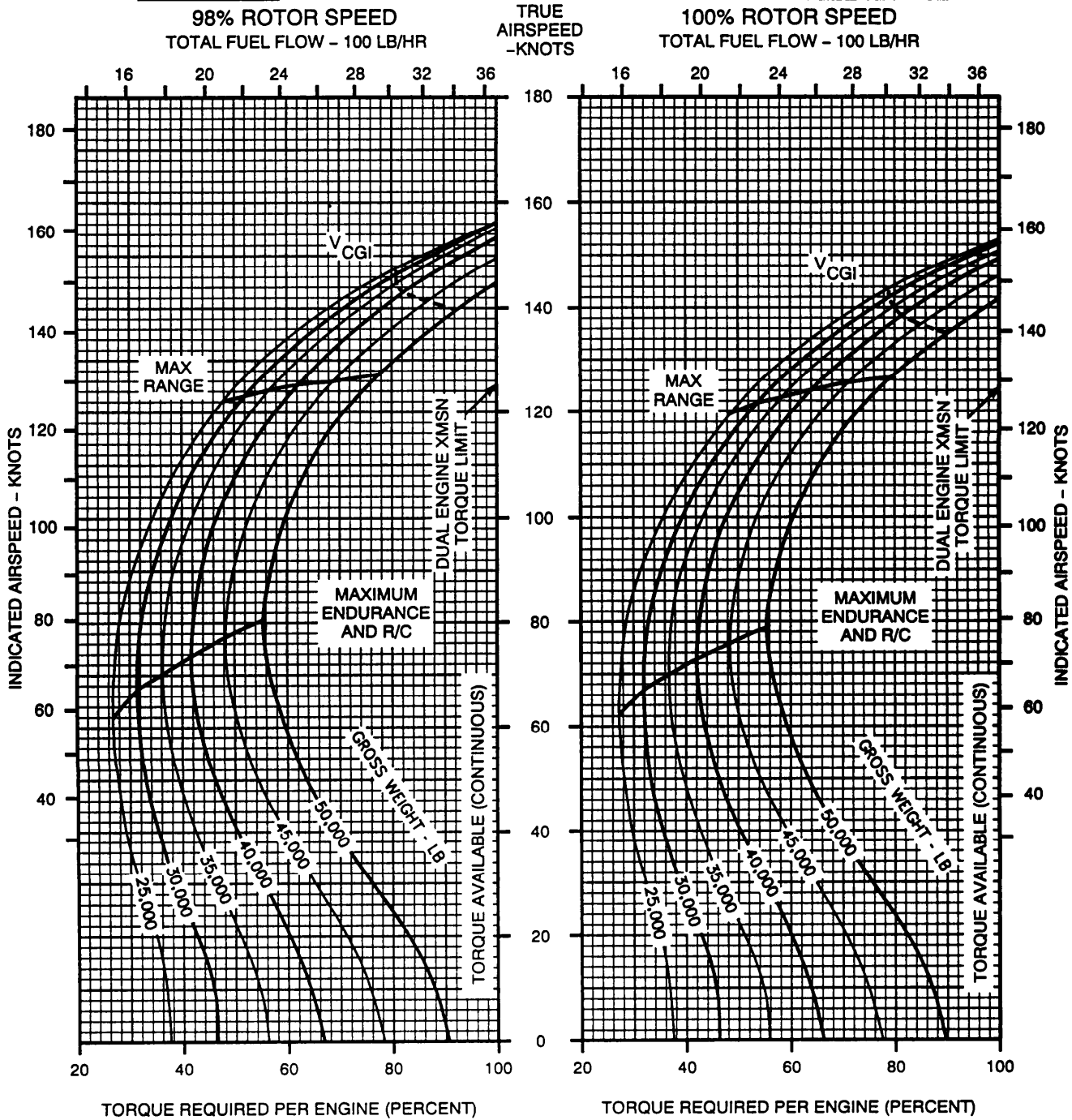
**PRESSURE ALTITUDE - 4000 FT**

**CRUISE  
CH-47D  
(2) T55-L-712**

**CLEAN CONFIGURATION JP-4 FUEL**

**FAT=-40 °C**

**FAT=-40 °C**



DATA BASIS: FLIGHT TEST

A9126

Figure 7-27. 98 and 100% Rotor RPM, -40°C, 4,000 Feet

**CRUISE**

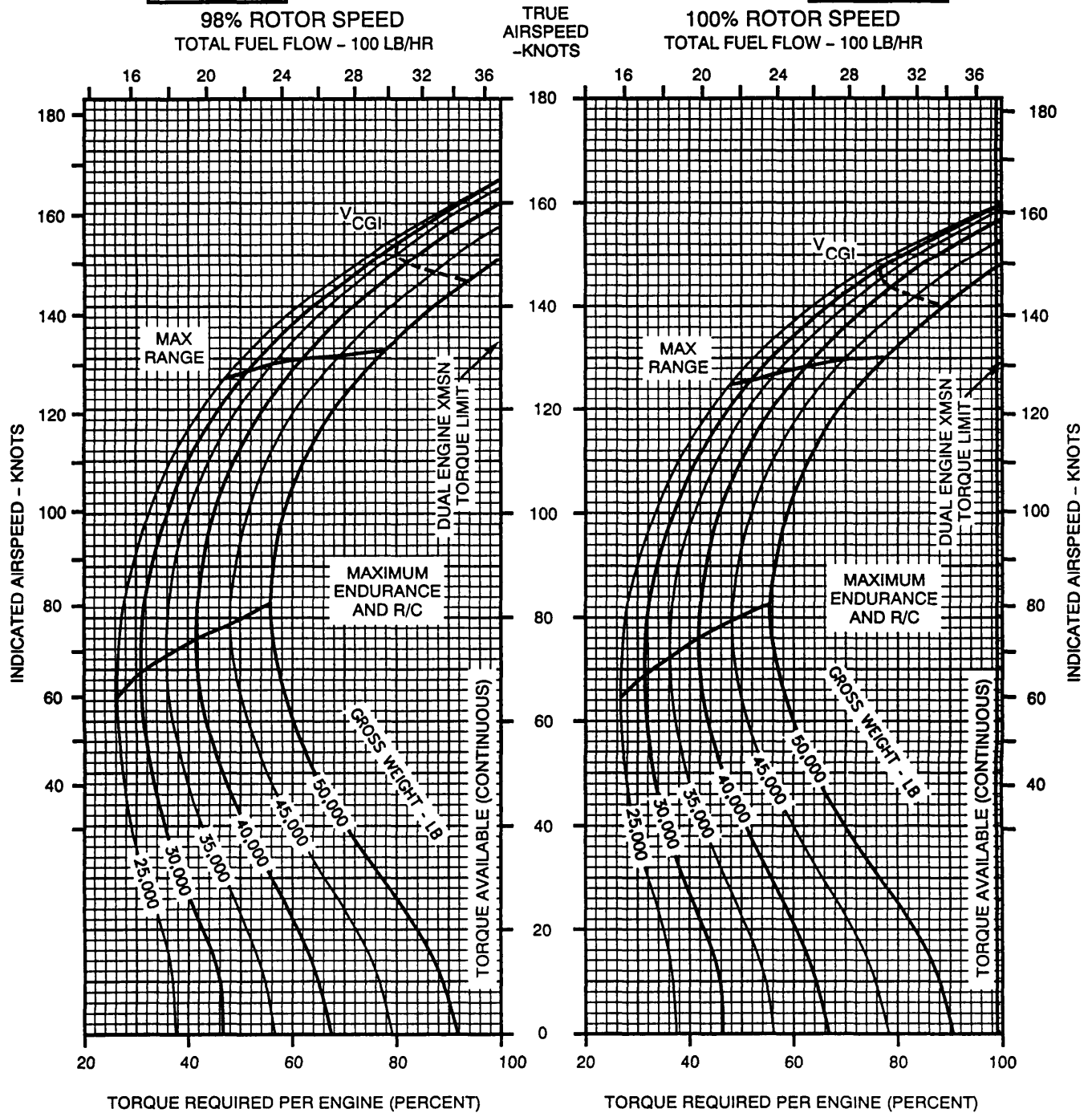
**PRESSURE ALTITUDE - 4000 FT**

**CRUISE  
CH-47D  
(2) T55-L-712**

**CLEAN CONFIGURATION JP-4 FUEL**

**FAT=-30 °C**

**FAT=-30 °C**



**DATA BASIS: FLIGHT TEST**

A9127

*Figure 7-28. 98 and 100% Rotor RPM, -30°C, 4,000 Feet*

**CRUISE**

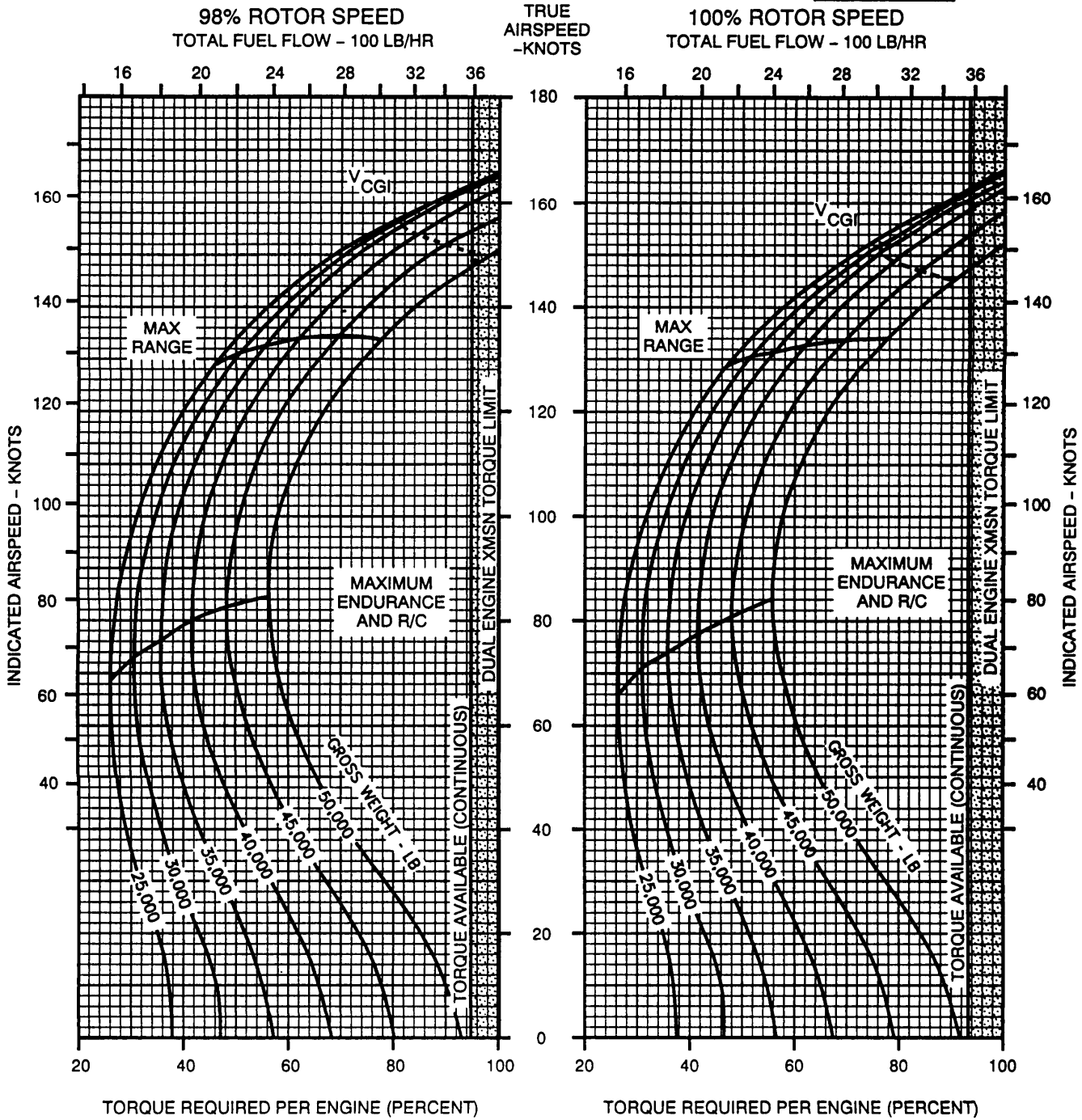
**PRESSURE ALTITUDE - 4000 FT**

**CRUISE  
CH-47D  
(2) T55-L-712**

**CLEAN CONFIGURATION JP-4 FUEL**

**FAT=-20 °C**

**FAT=-20 °C**



DATA BASIS: FLIGHT TEST

A21192

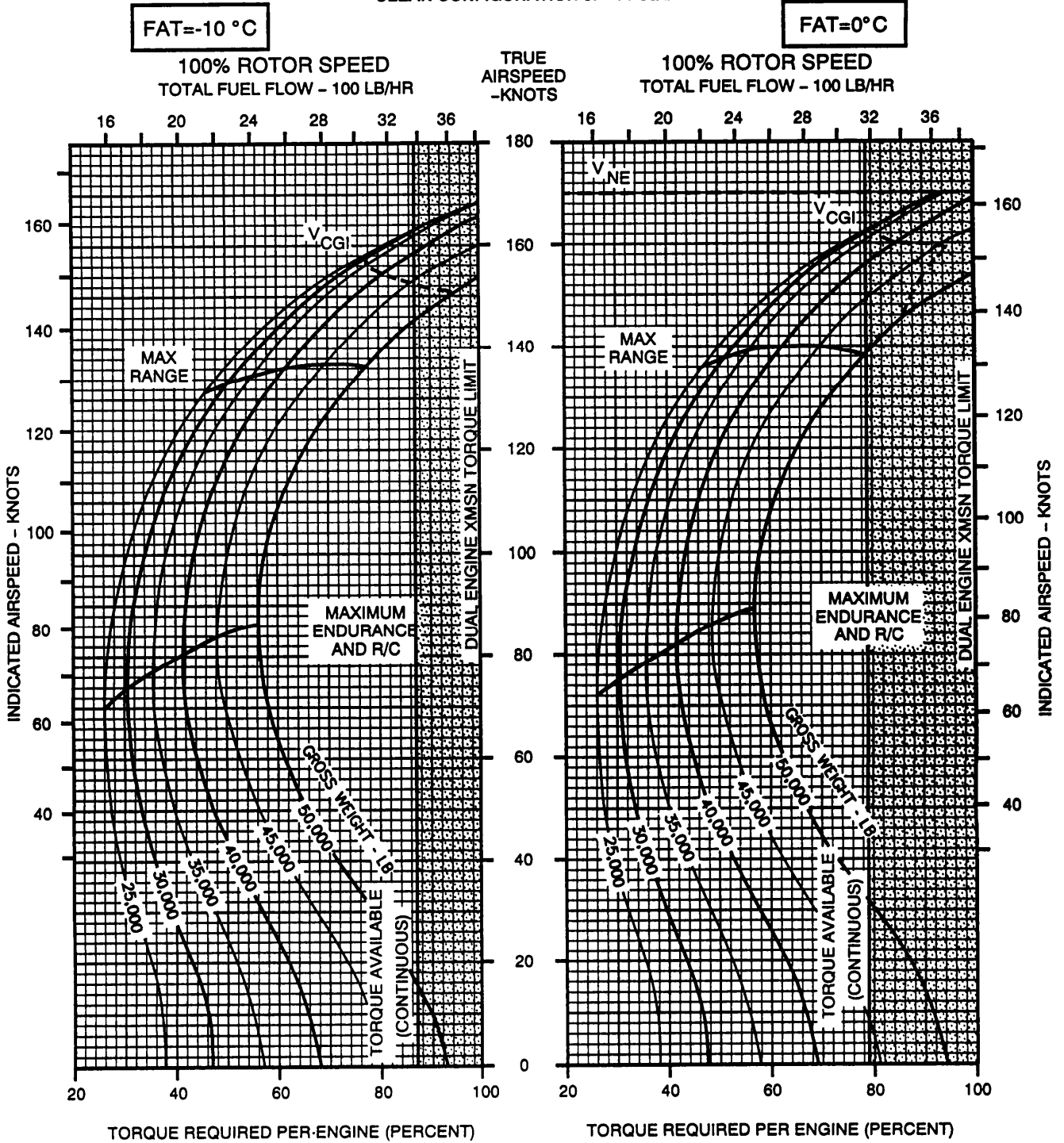
Figure 7-29. 98 and 100% Rotor RPM, -20°C, 4,000 Feet

# CRUISE

## PRESSURE ALTITUDE - 4000 FT

CRUISE  
CH-47D  
(2) T55-L-712

CLEAN CONFIGURATION JP-4 FUEL



DATA BASIS: FLIGHT TEST

A21193

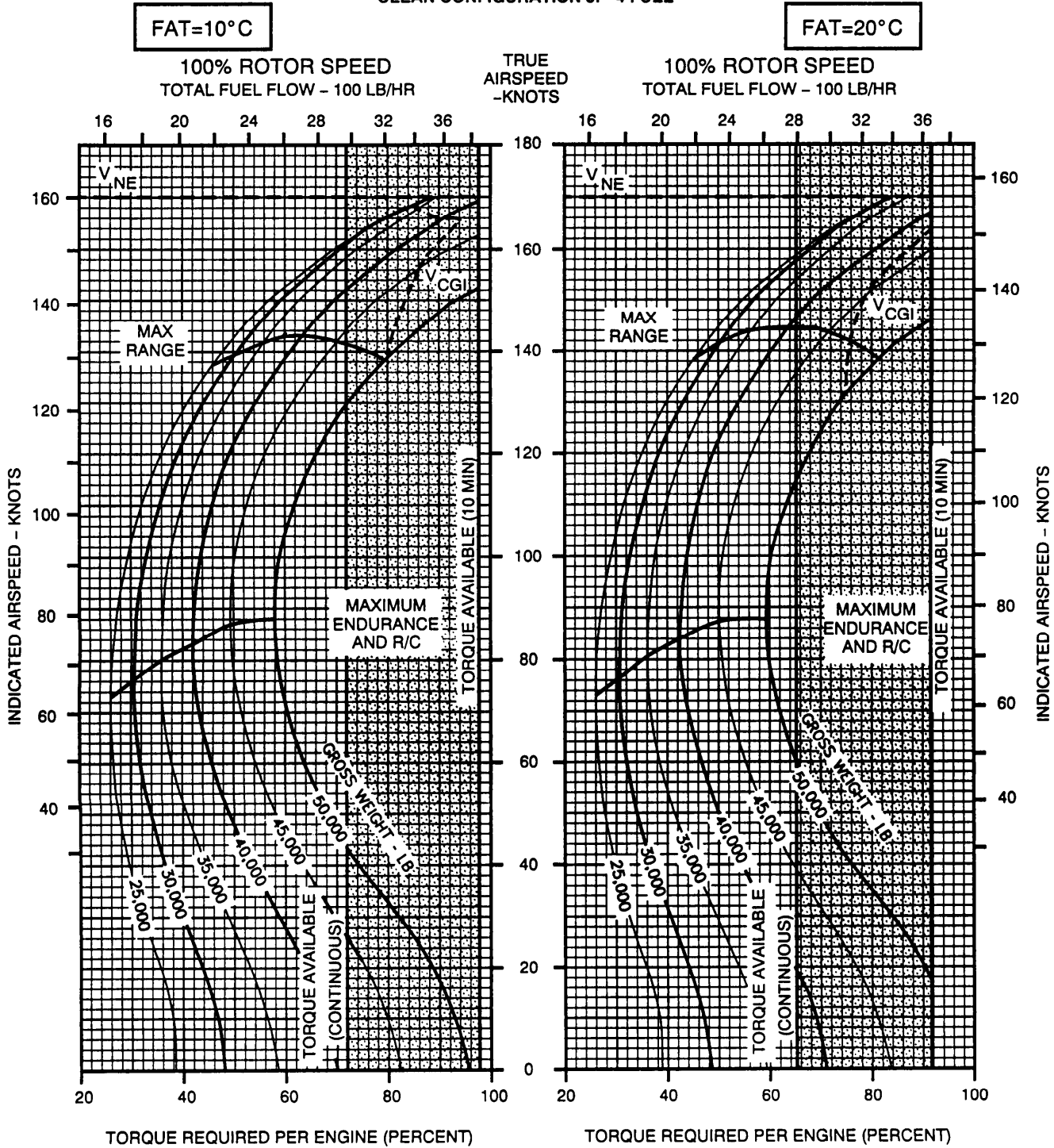
Figure 7-30. 100% Rotor RPM, -10° and 0°C, 4,000 Feet

**CRUISE**

**PRESSURE ALTITUDE - 4000 FT**

**CRUISE  
CH-47D  
(2) T55-L-712**

**CLEAN CONFIGURATION JP-4 FUEL**



DATA BASIS: FLIGHT TEST

A21194

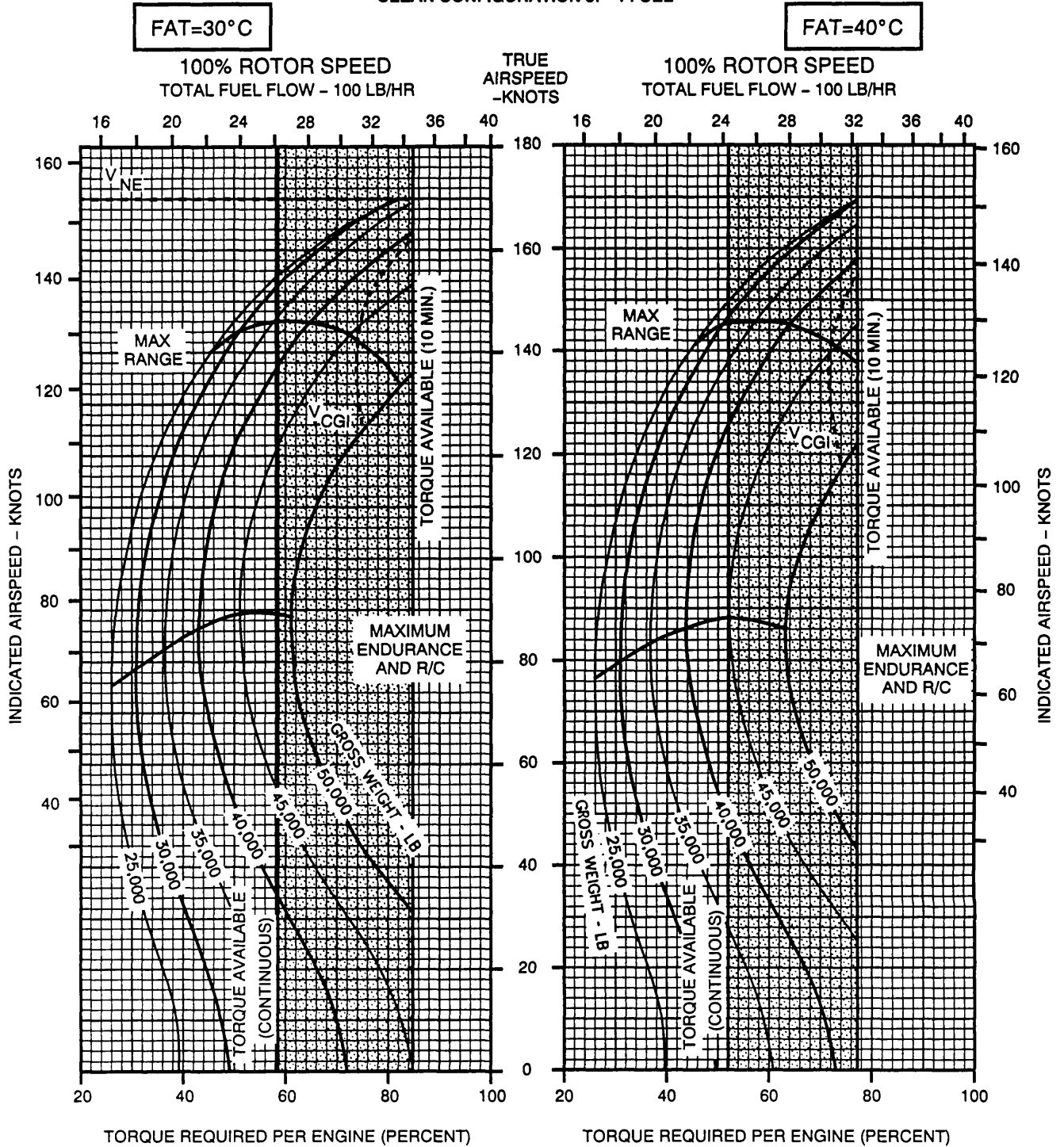
Figure 7-31. 100% Rotor RPM, 10° and 20°C, 4,000 Feet

# CRUISE

## PRESSURE ALTITUDE - 4000 FT

CRUISE  
CH-47D  
(2) T55-L-712

CLEAN CONFIGURATION JP-4 FUEL



DATA BASIS: FLIGHT TEST

A21195

Figure 7-32. 100% Rotor RPM, 30° and 40°C, 4,000 Feet



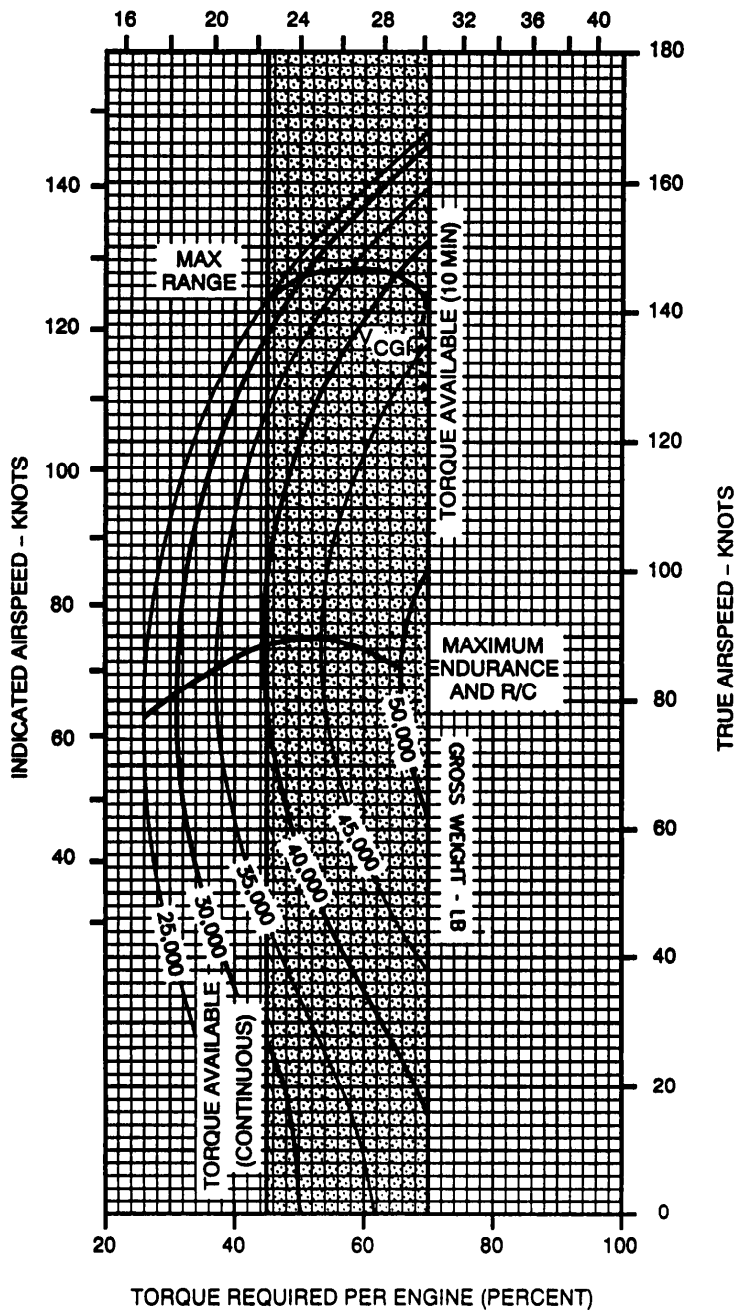
**CRUISE**  
**PRESSURE ALTITUDE - 4000 FT**

**CRUISE**  
**CH-47D**  
**(2) T55-L-712**

**CLEAN CONFIGURATION JP-4 FUEL**

**FAT=50°C**

**100% ROTOR SPEED**  
**TOTAL FUEL FLOW - 100 LB/HR**



**DATA BASIS: FLIGHT TEST**

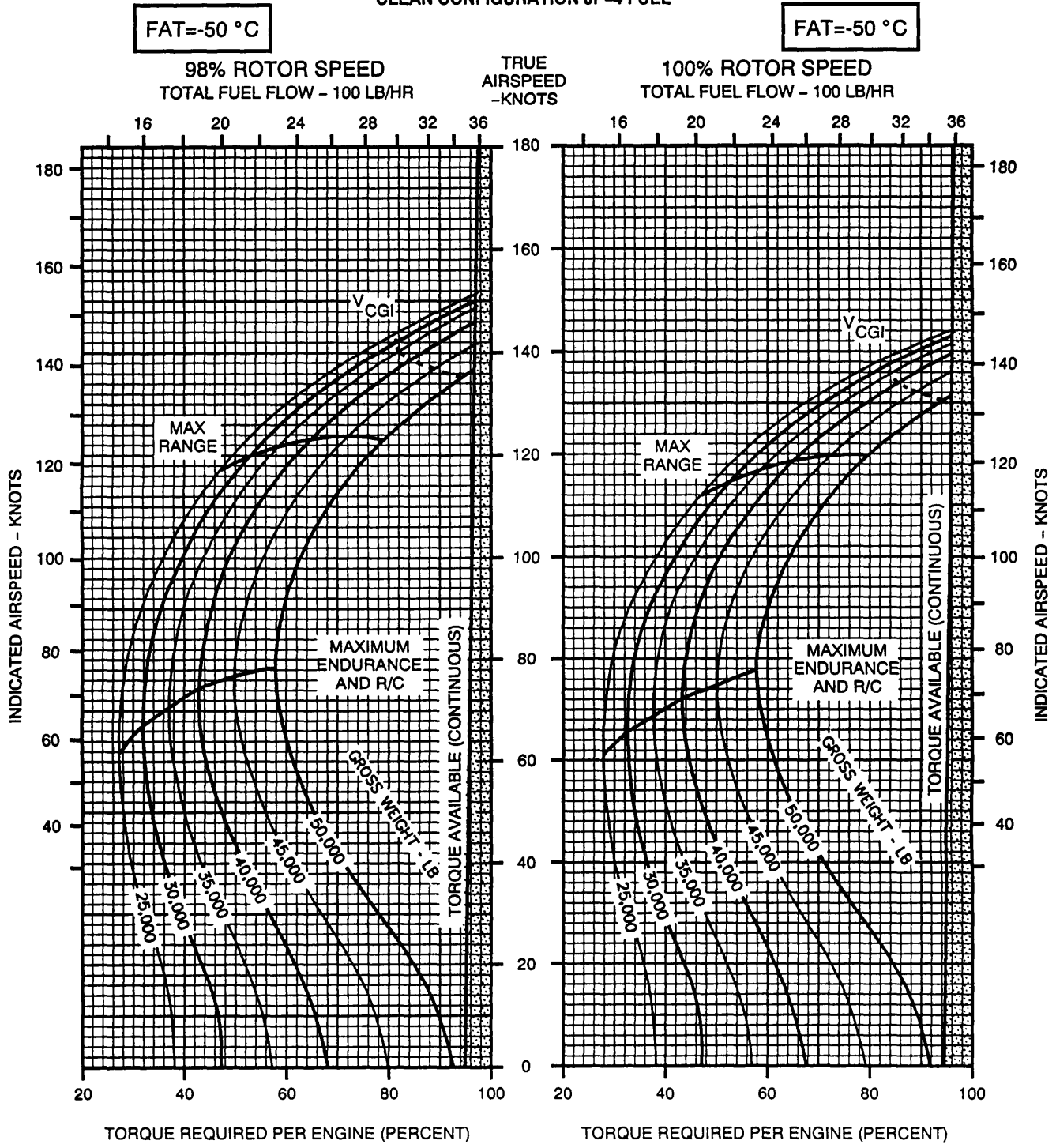
**A9128**

*Figure 7-33. 100% Rotor RPM, 50°C, 4,000 Feet*

**CRUISE**  
**PRESSURE ALTITUDE - 6000 FT**

**CRUISE**  
**CH-47D**  
**(2) T55-L-712**

CLEAN CONFIGURATION JP-4 FUEL



DATA BASIS: FLIGHT TEST

A9134

Figure 7-34. 98 and 100% Rotor RPM, -50°C, 6,000 Feet

**CRUISE**

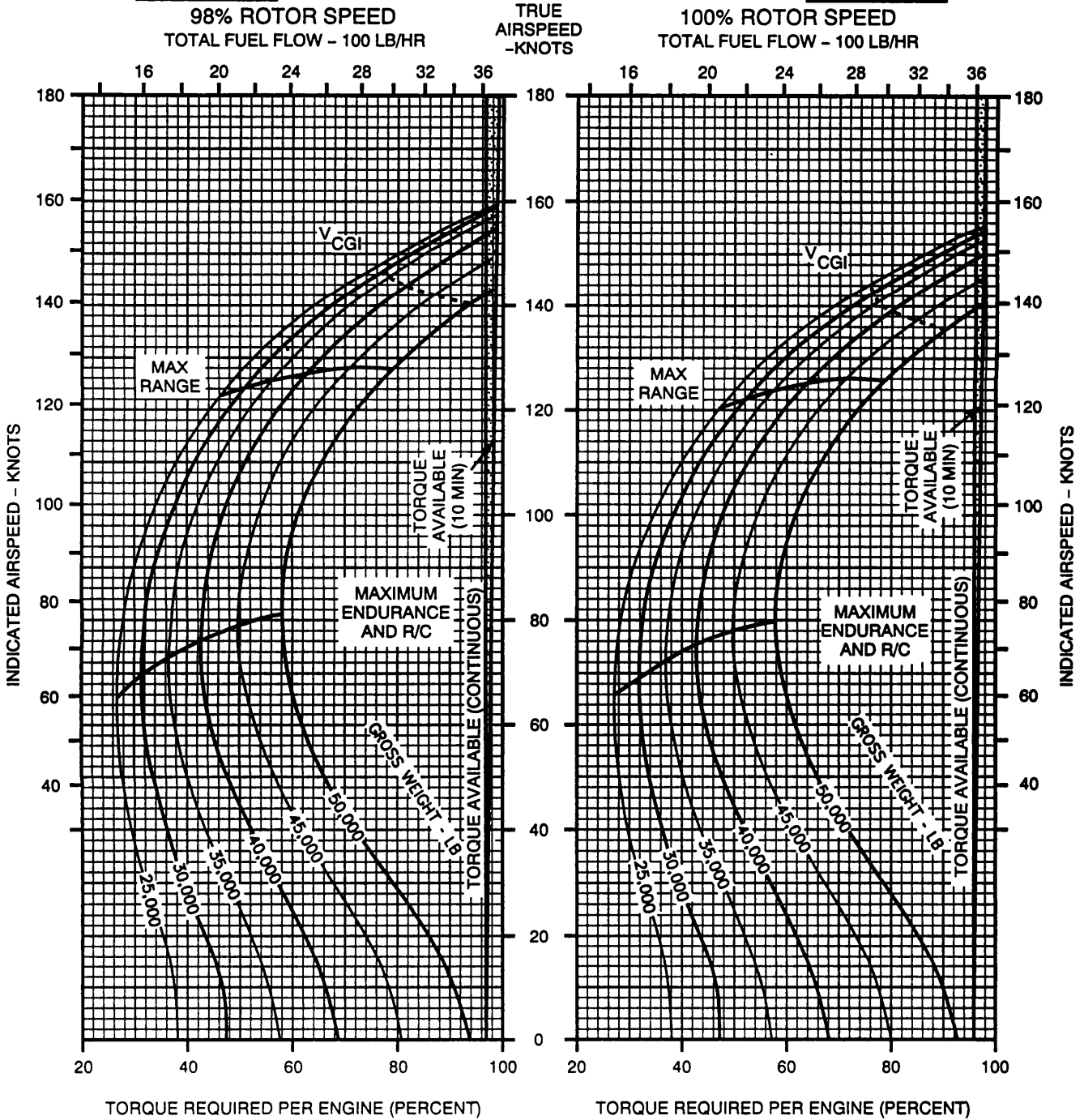
**PRESSURE ALTITUDE - 6000 FT**

**CRUISE  
CH-47D  
(2) T55-L-712**

**CLEAN CONFIGURATION JP-4 FUEL**

**FAT=-40 °C**

**FAT=-40 °C**



DATA BASIS: FLIGHT TEST

A9135

Figure 7-35. 98 and 100% Rotor RPM, -40°C, 6,000 Feet

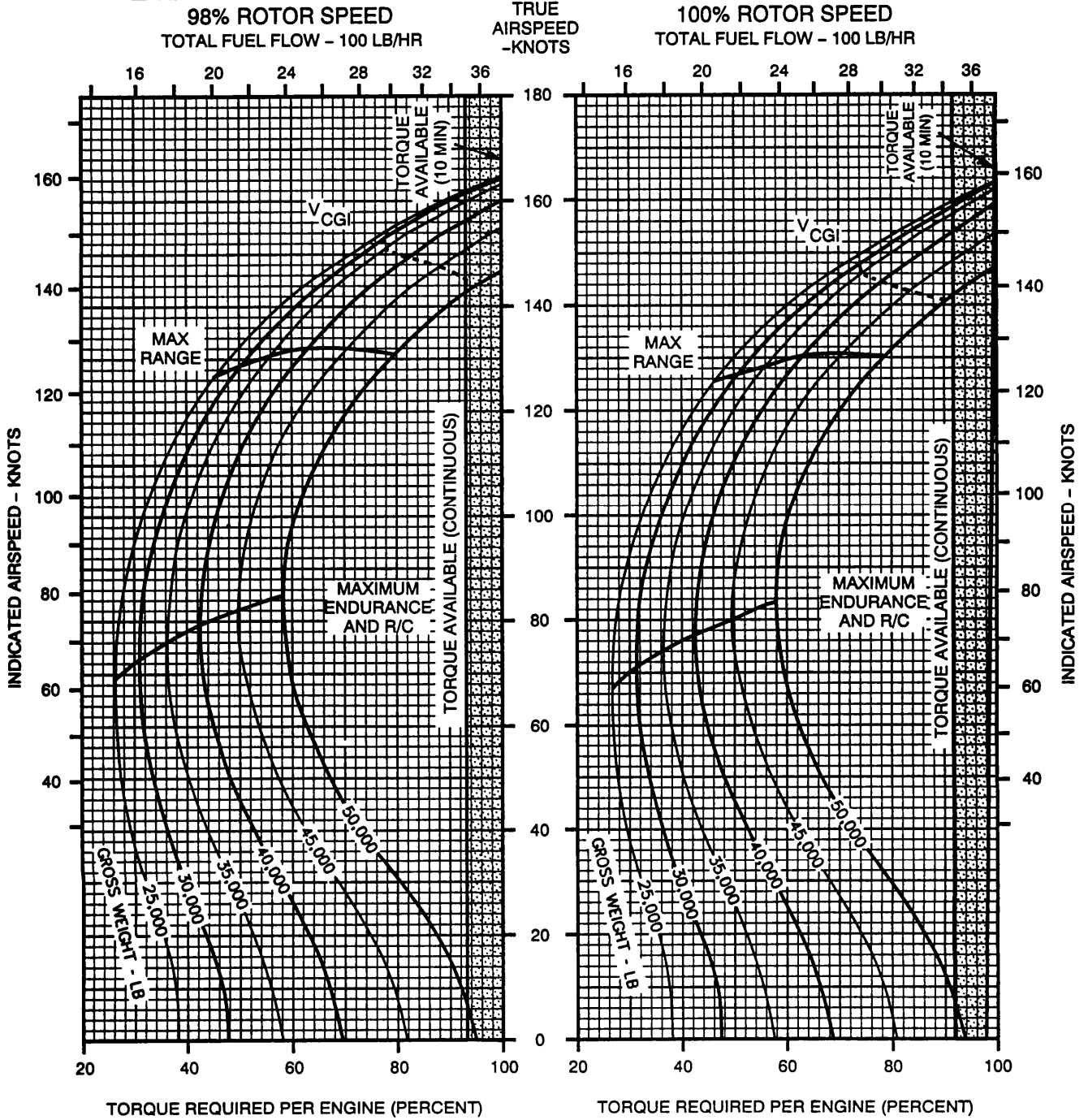
**CRUISE**  
**PRESSURE ALTITUDE - 6000 FT**

**CRUISE**  
**CH-47D**  
**(2) T55-L-712**

CLEAN CONFIGURATION JP-4 FUEL

**FAT=-30 °C**

**FAT=-30 °C**



DATA BASIS: FLIGHT TEST

A9276

Figure 7-36. 98 and 100% Rotor RPM, -30°C, 6,000 Feet

# CRUISE

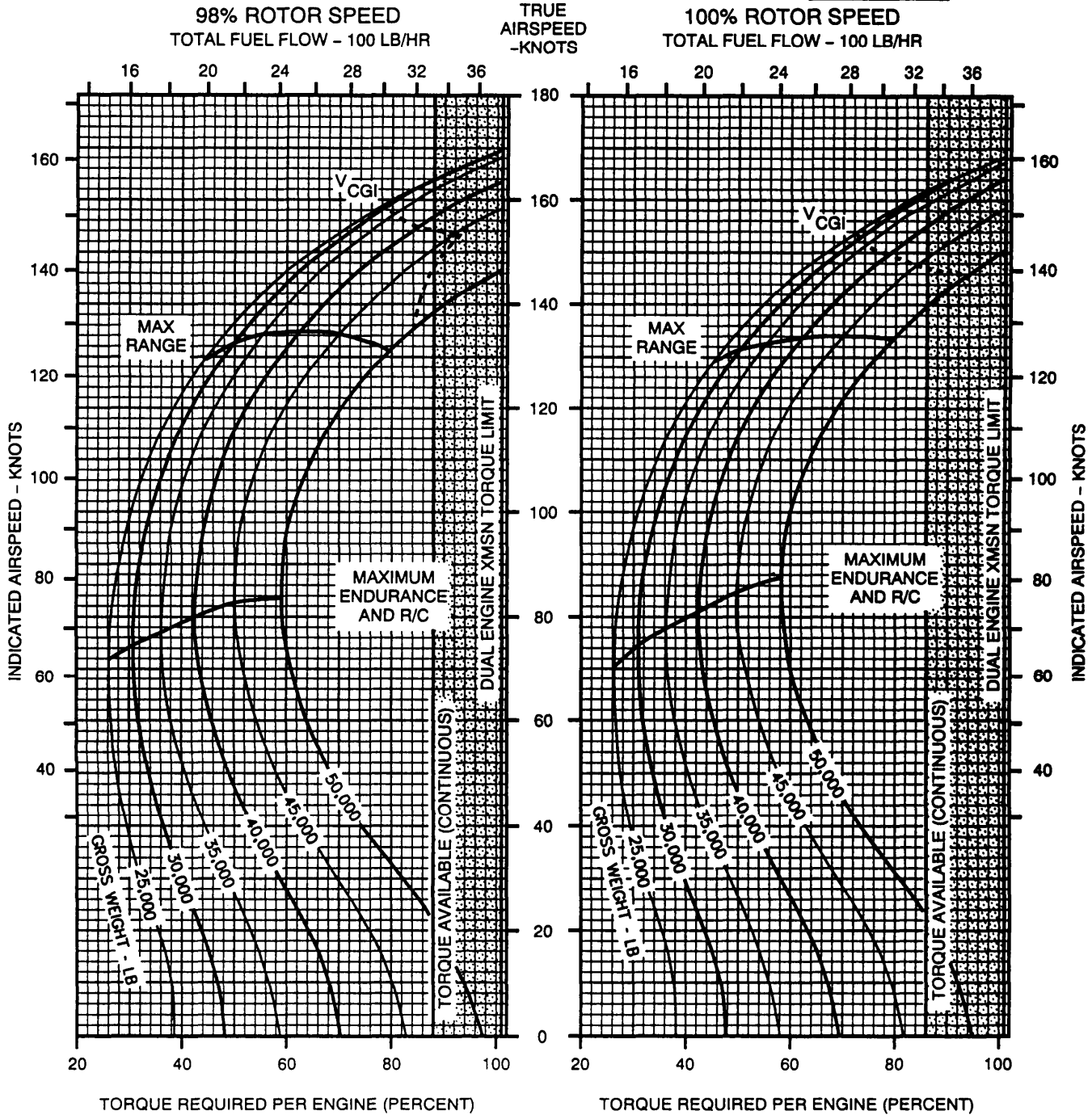
PRESSURE ALTITUDE - 6000 FT

CRUISE  
CH-47D  
(2) T55-L-712

CLEAN CONFIGURATION JP-4 FUEL

FAT=-20 °C

FAT=-20 °C



DATA BASIS: FLIGHT TEST

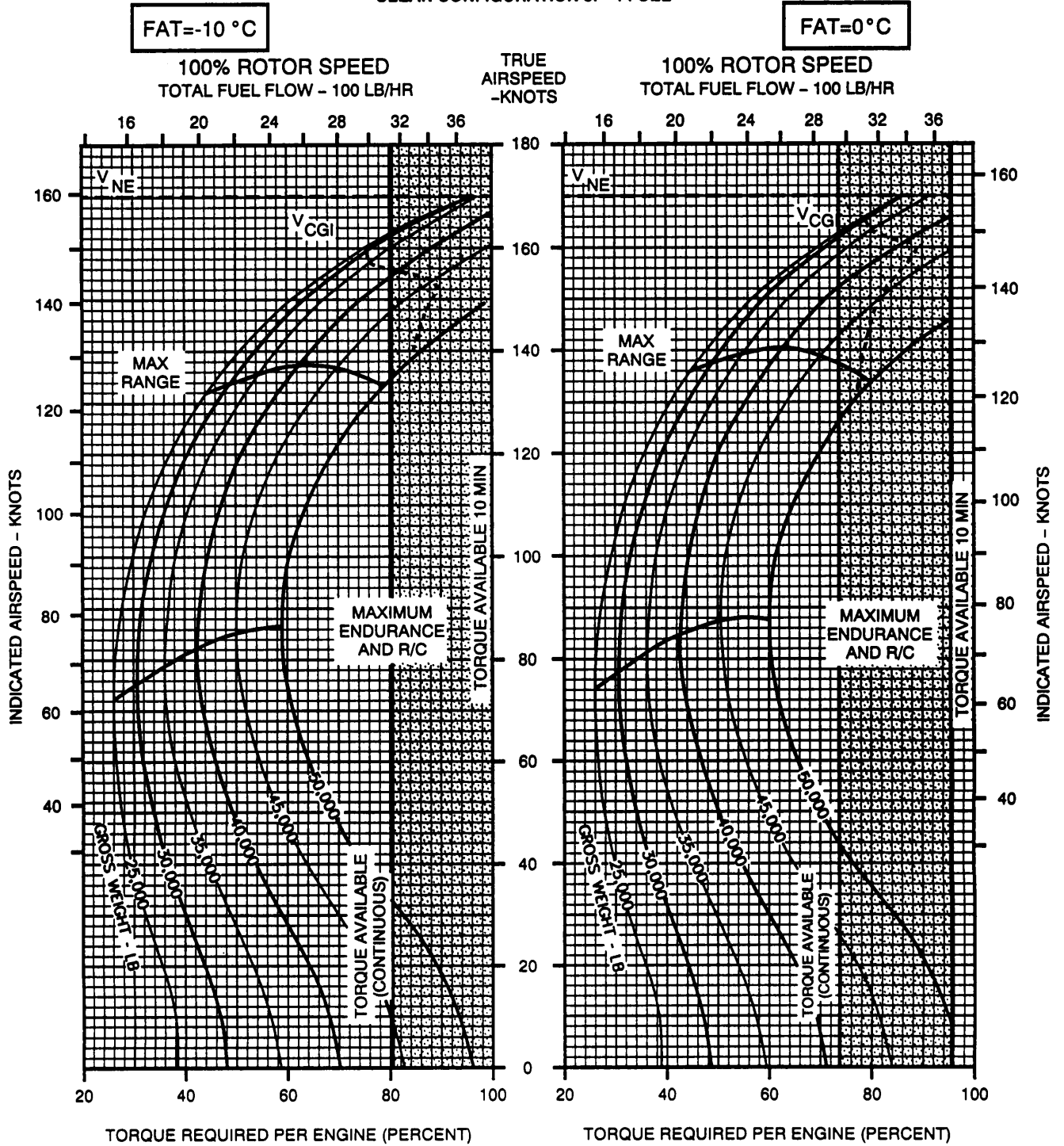
A21198

Figure 7-37. 98 and 100% Rotor RPM, -20°C, 6,000 Feet

**CRUISE**  
**PRESSURE ALTITUDE - 6000 FT**

**CRUISE**  
**CH-47D**  
**(2) T55-L-712**

CLEAN CONFIGURATION JP-4 FUEL



DATA BASIS: FLIGHT TEST

A21260

Figure 7-38. 100% Rotor RPM, -10° and 0°C, 6,000 Feet

**CRUISE**

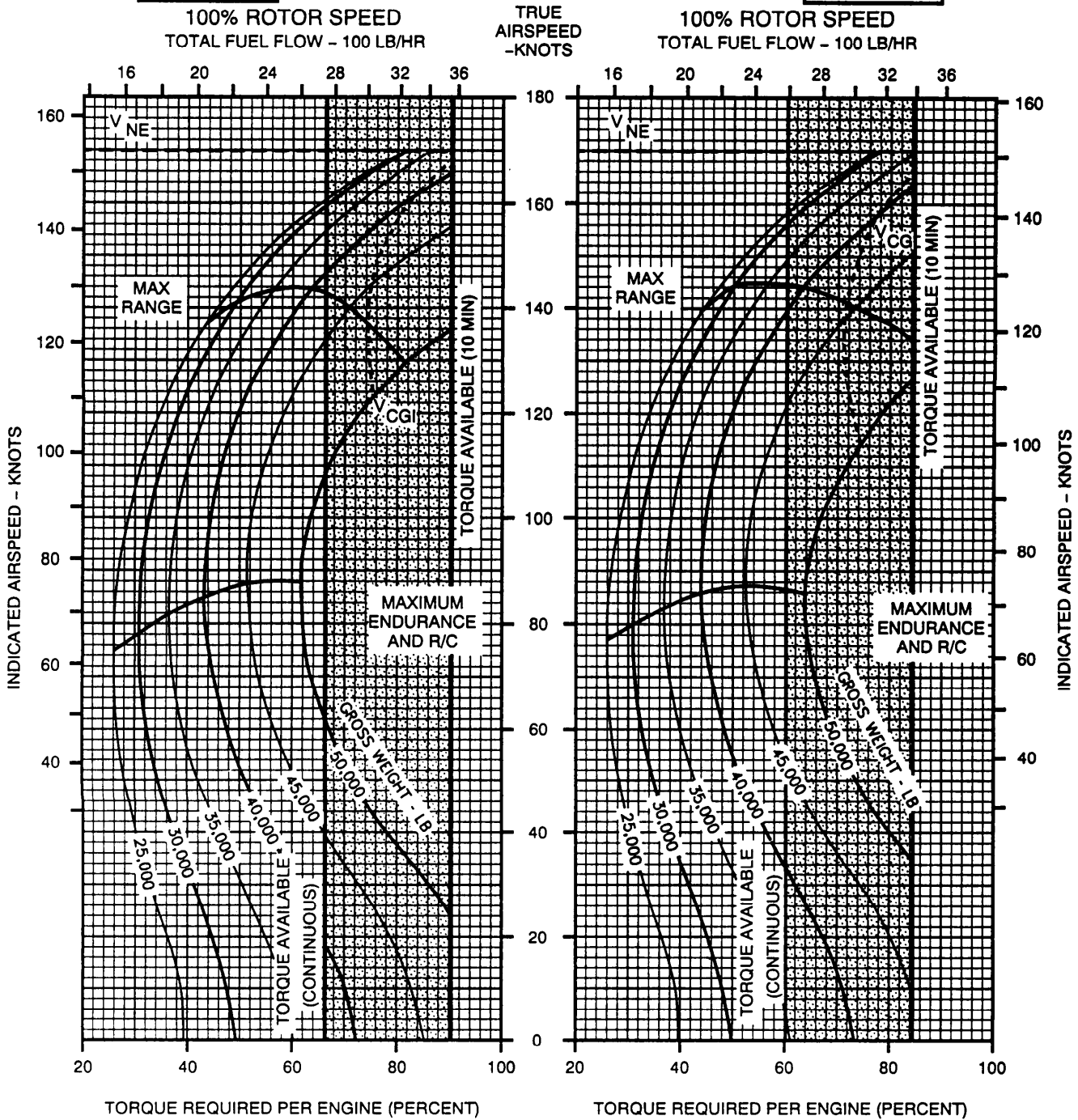
**PRESSURE ALTITUDE - 6000 FT**

**CRUISE  
CH-47D  
(2) T55-L-712**

**CLEAN CONFIGURATION JP-4 FUEL**

**FAT=10°C**

**FAT=20°C**



DATA BASIS: FLIGHT TEST

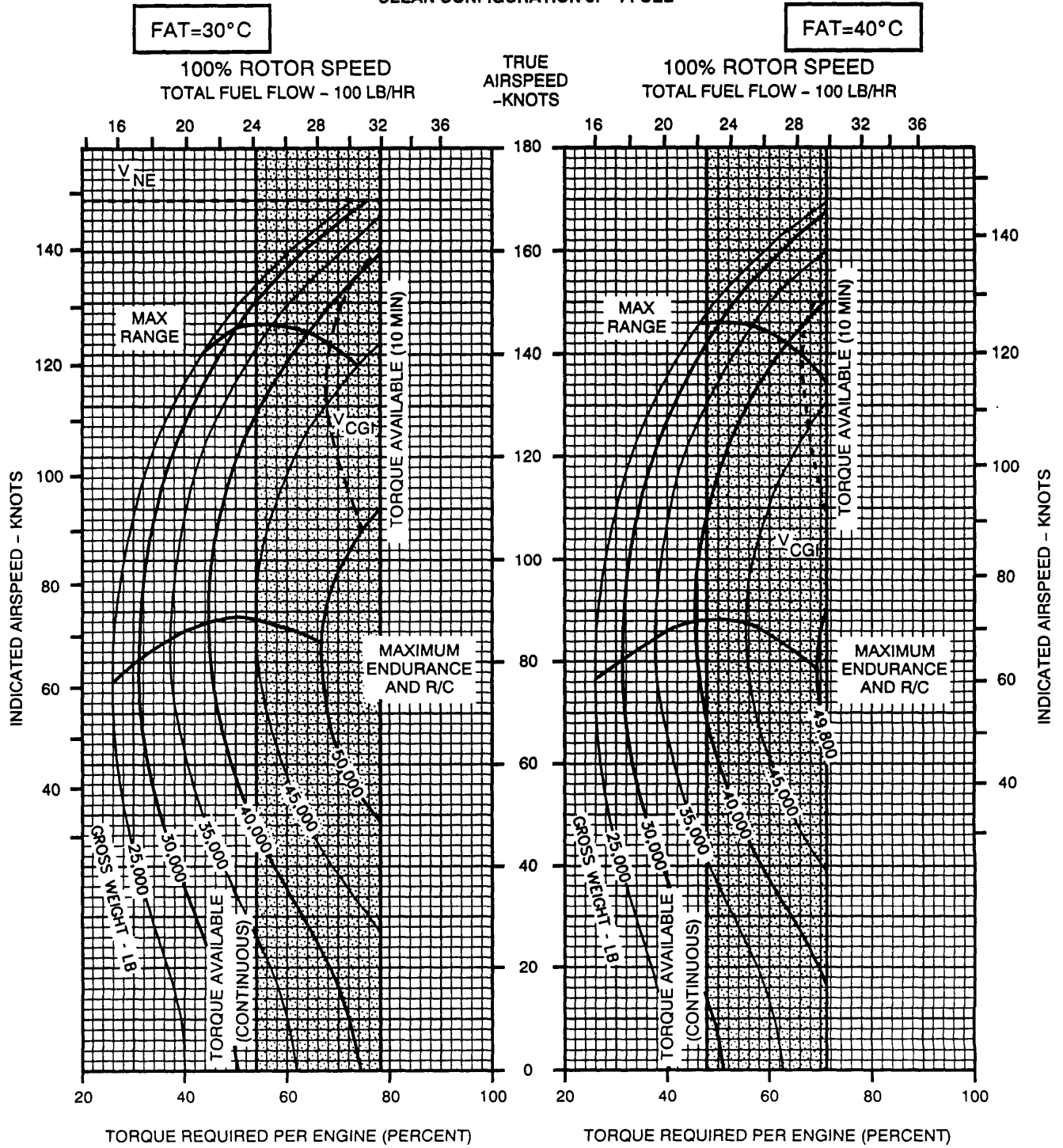
A21197

**Figure 7-39. 100% Rotor RPM, 10° and 20°C, 6,000 Feet**

**CRUISE**  
**PRESSURE ALTITUDE - 6000 FT**

**CRUISE**  
**CH-47D**  
**(2) T55-L-712**

CLEAN CONFIGURATION JP-4 FUEL



DATA BASIS: FLIGHT TEST

A21198

Figure 7-40. 100% Rotor RPM, 30° and 40°C, 6,000 Feet



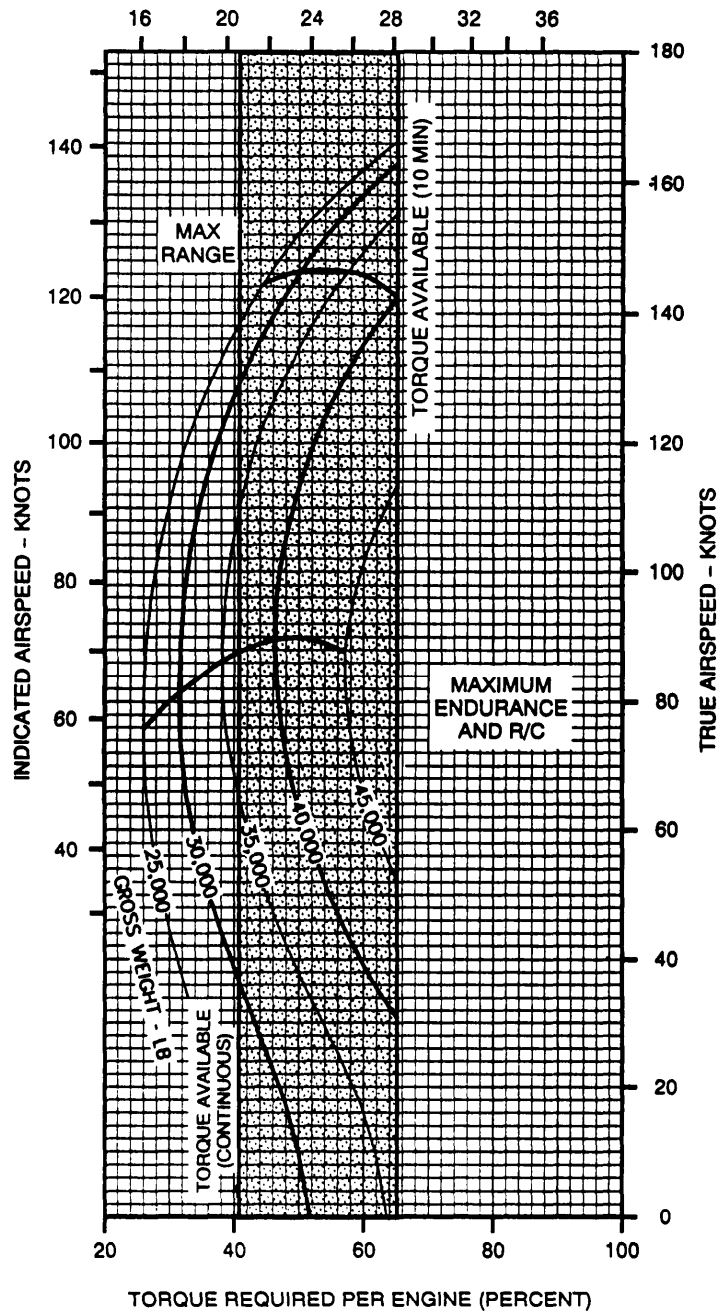
**CRUISE**  
**PRESSURE ALTITUDE - 6000 FT**

**CRUISE**  
**CH-47D**  
**(2) T55-L-712**

**CLEAN CONFIGURATION JP-4 FUEL**

**FAT=50°C**

**100% ROTOR SPEED**  
**TOTAL FUEL FLOW - 100 LB/HR**



**DATA BASIS: FLIGHT TEST**

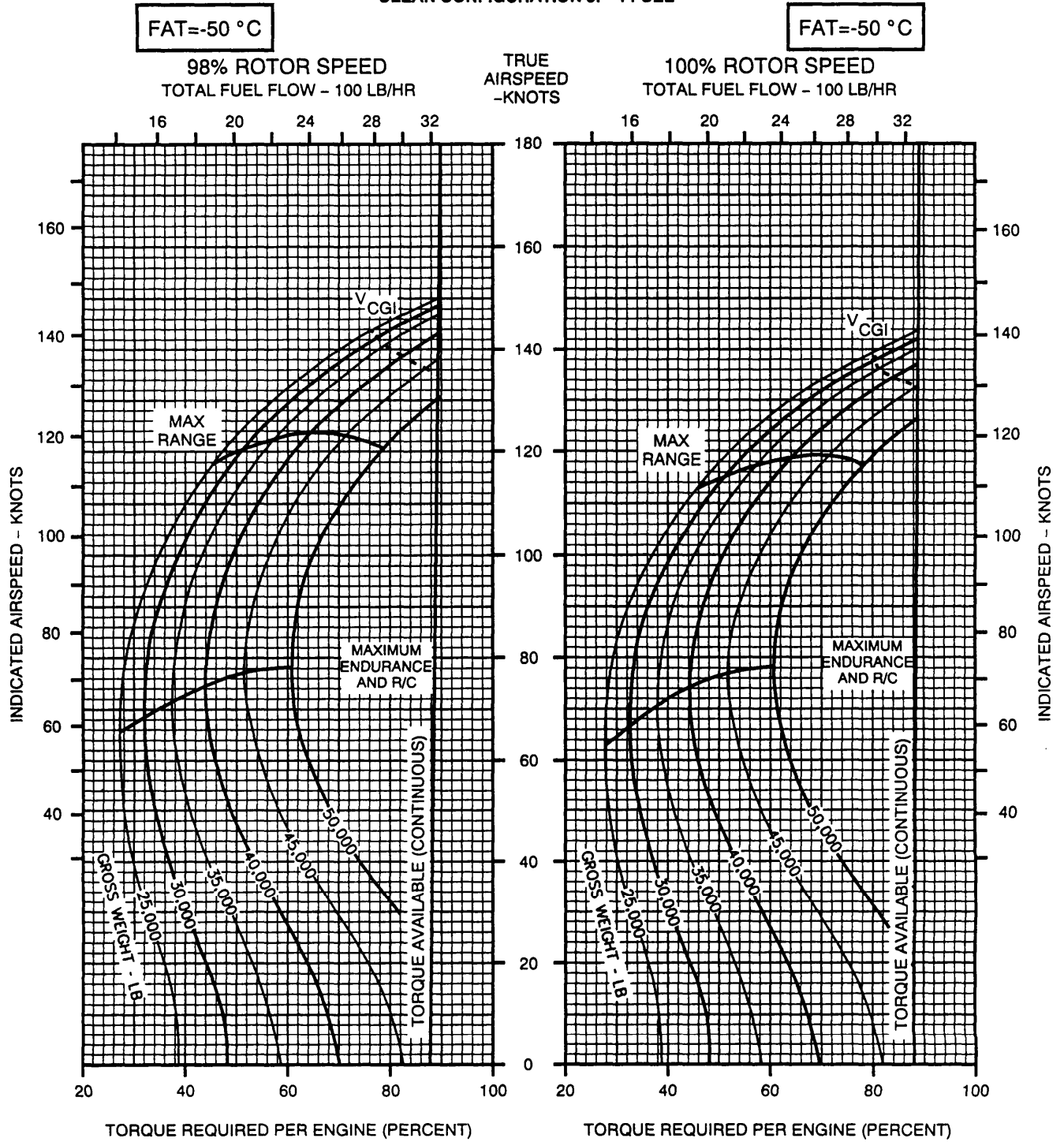
**A9277**

**Figure 7-41. 100% Rotor RPM, 50°C, 6,000 Feet**

**CRUISE**  
**PRESSURE ALTITUDE - 8000 FT**

**CRUISE**  
**CH-47D**  
**(2) T55-L-712**

CLEAN CONFIGURATION JP-4 FUEL



DATA BASIS: FLIGHT TEST

A9407

Figure 7-42. 98 and 100% RPM, -5°C, 8,000 Feet

# CRUISE

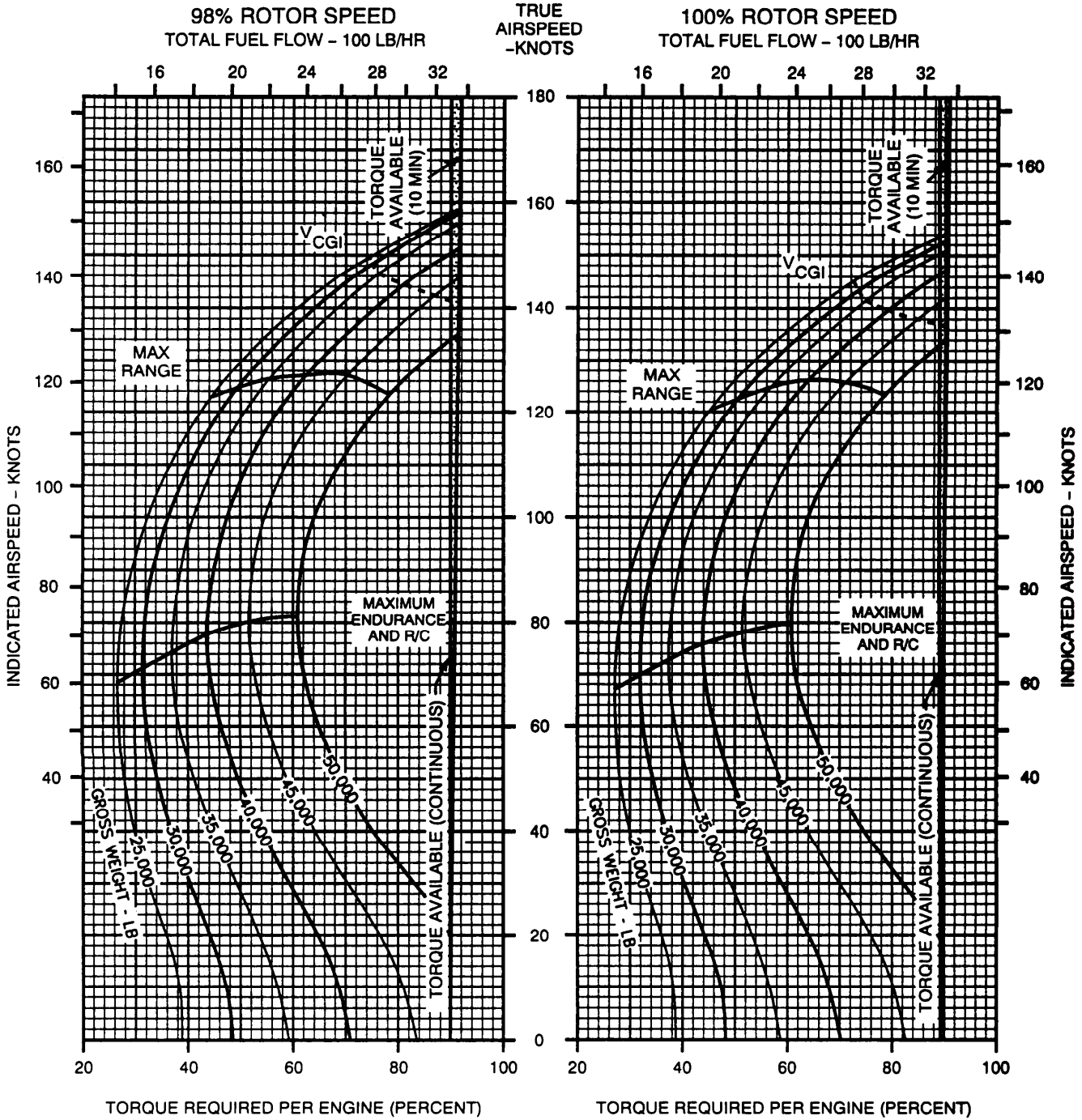
PRESSURE ALTITUDE - 8000 FT

CRUISE  
CH-47D  
(2) T55-L-712

CLEAN CONFIGURATION JP-4 FUEL

FAT=-40 °C

FAT=-40 °C



DATA BASIS: FLIGHT TEST

A9278

Figure 7-43. 98 and 100% Rotor RPM, -4°C, 8,000 Feet

**CRUISE**

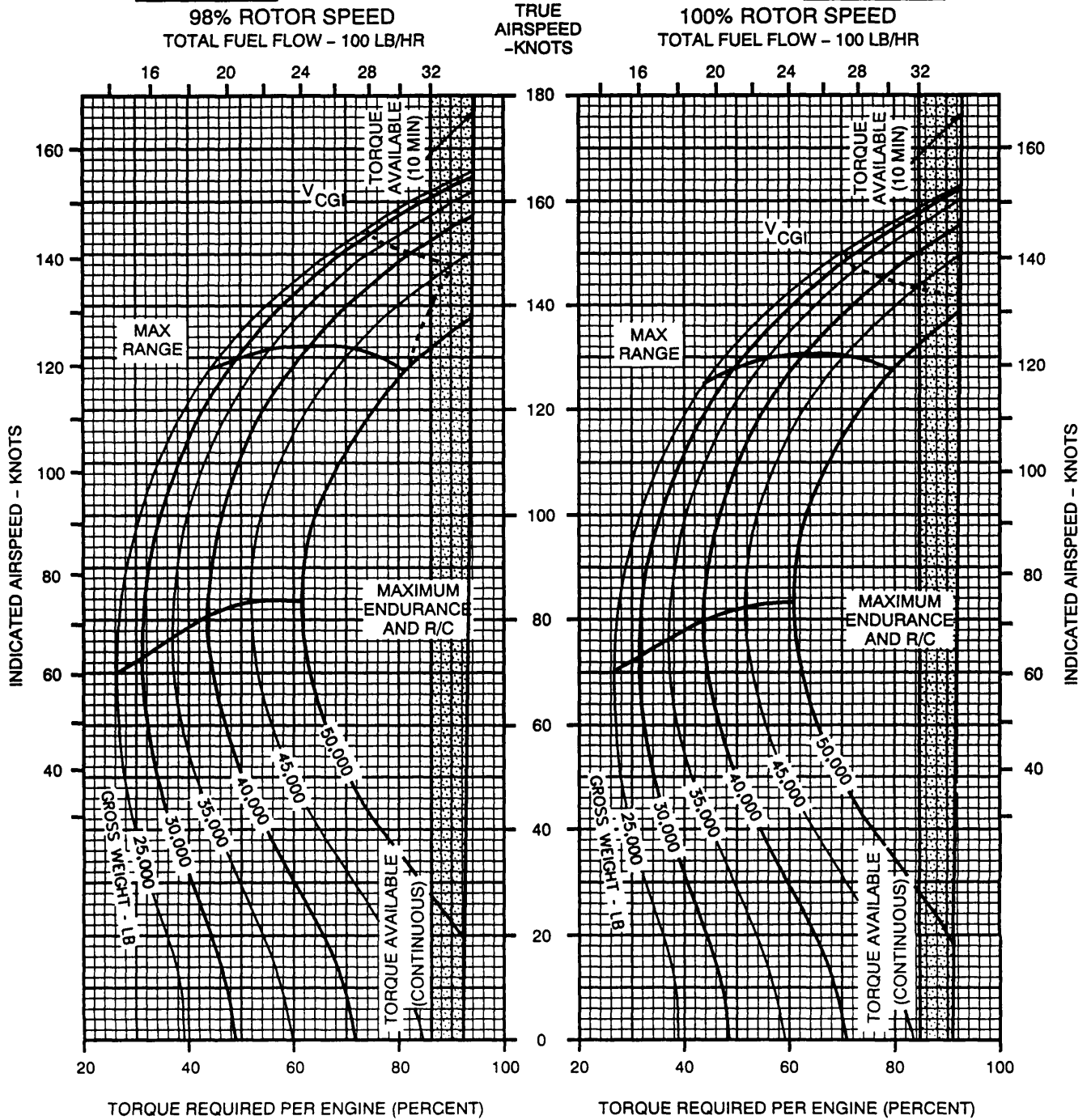
**PRESSURE ALTITUDE - 8000 FT**

**CRUISE  
CH-47D  
(2) T55-L-712**

**CLEAN CONFIGURATION JP-4 FUEL**

**FAT=-30 °C**

**FAT=-30 °C**



**DATA BASIS:** FLIGHT TEST

A9279

**Figure 7-44. 98 and 100% Rotor RPM, -30°C, 8,000 Feet**

**CRUISE**

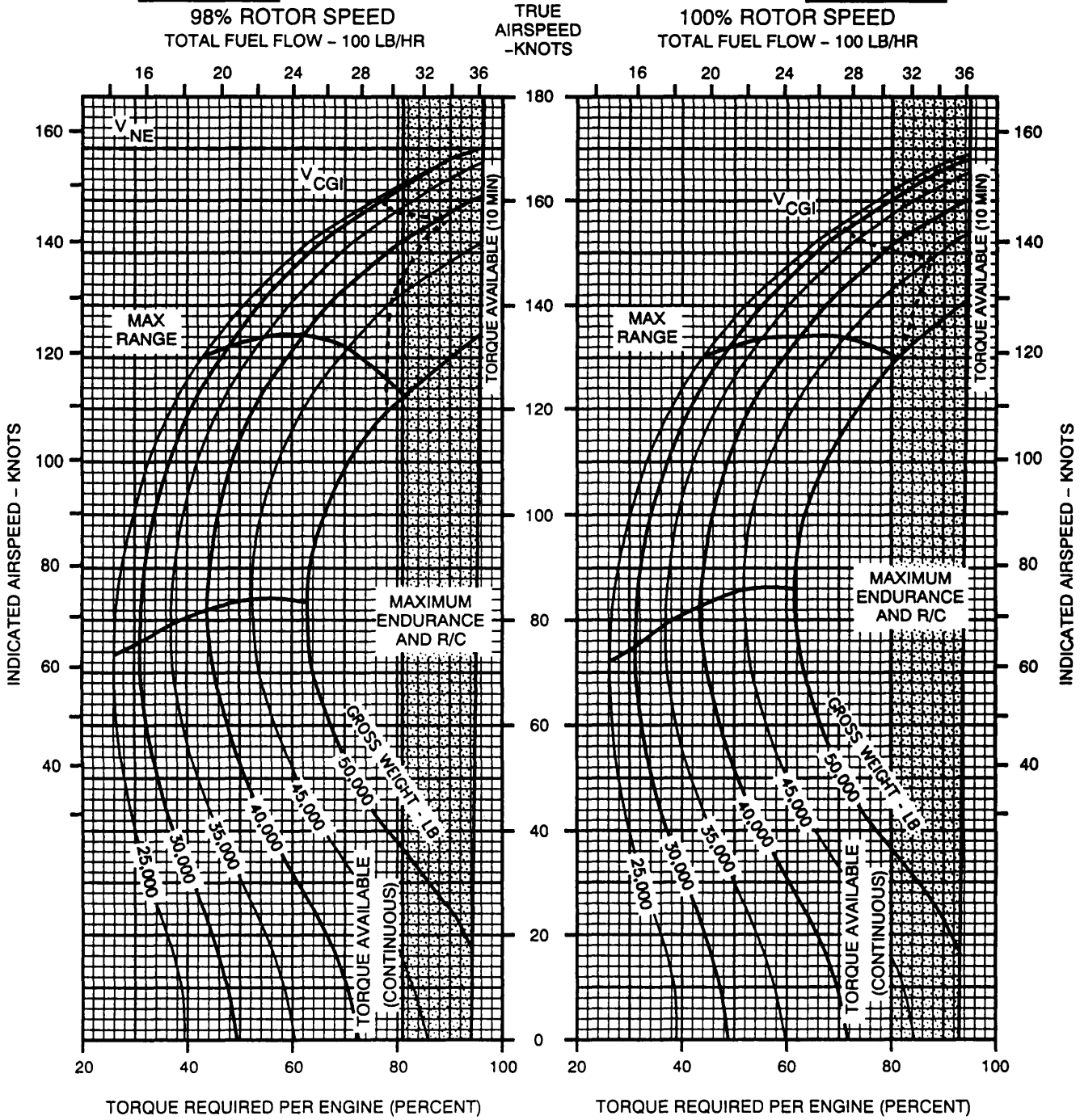
**PRESSURE ALTITUDE - 8000 FT**

**CRUISE  
CH-47D  
(2) T55-L-712**

**CLEAN CONFIGURATION JP-4 FUEL**

**FAT=-20 °C**

**FAT=-20 °C**



DATA BASIS: FLIGHT TEST

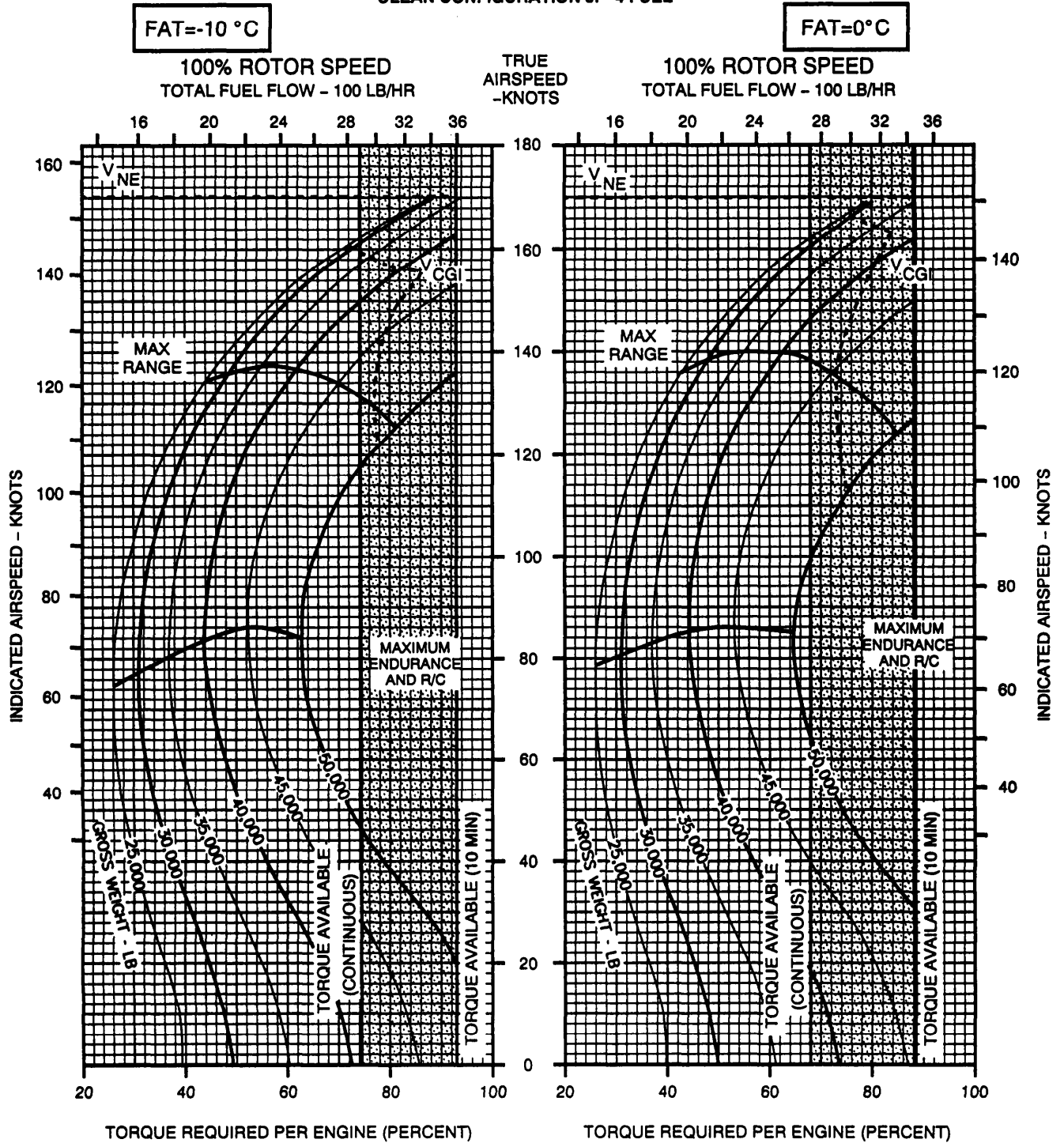
A21199

Figure 7-45. 98 and 100% Rotor RPM, -2°C, 8,000 Feet

**CRUISE**  
**PRESSURE ALTITUDE - 8000 FT**

**CRUISE**  
**CH-47D**  
**(2) T55-L-712**

CLEAN CONFIGURATION JP-4 FUEL



DATA BASIS: FLIGHT TEST

A21200

Figure 7-46. 100% Rotor RPM, -10° and 0°C, 8,000 Feet

**CRUISE**

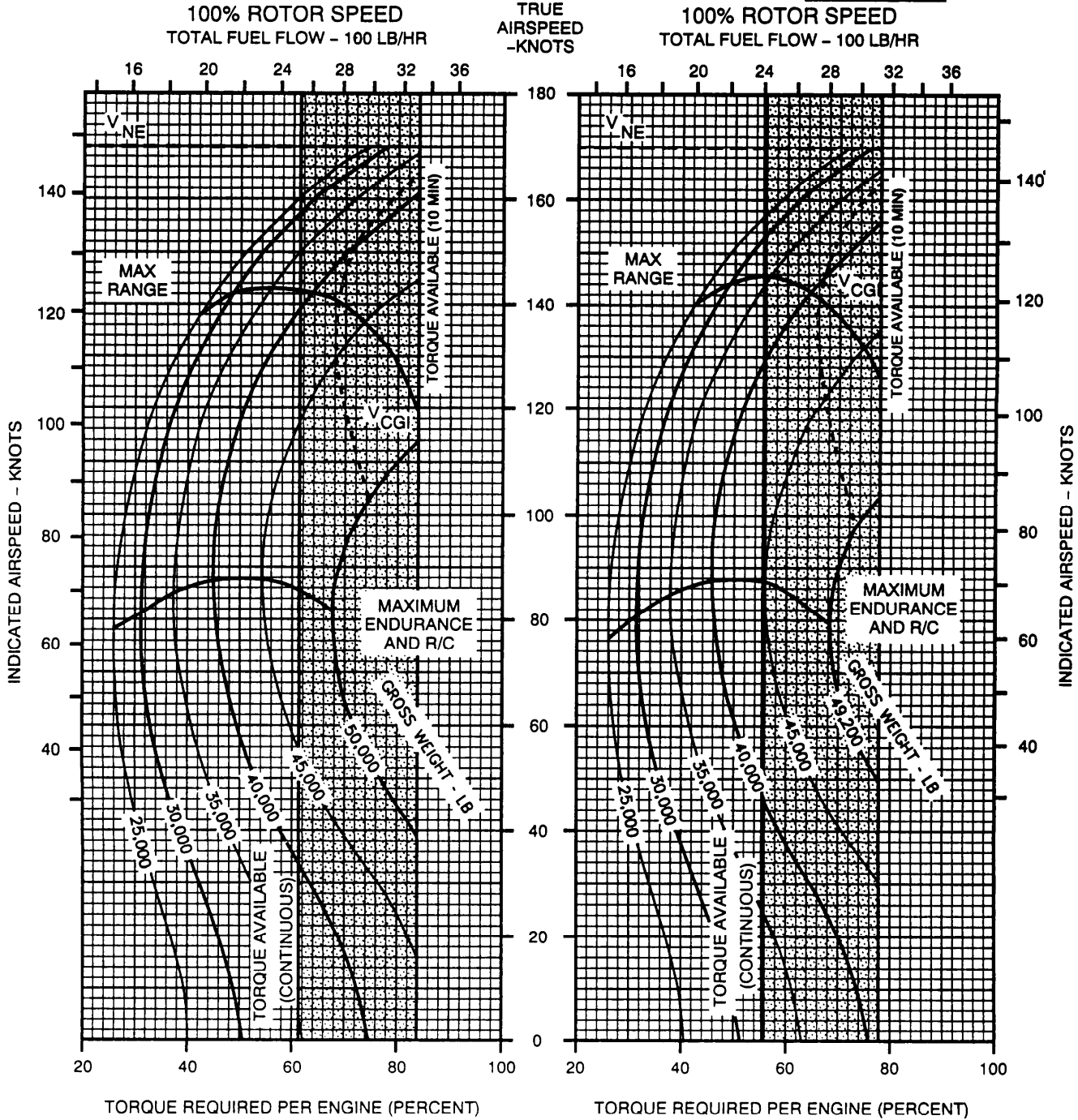
**PRESSURE ALTITUDE - 8000 FT**

**CRUISE  
CH-47D  
(2) T55-L-712**

**CLEAN CONFIGURATION JP-4 FUEL**

**FAT=10°C**

**FAT=20°C**



DATA BASIS: FLIGHT TEST

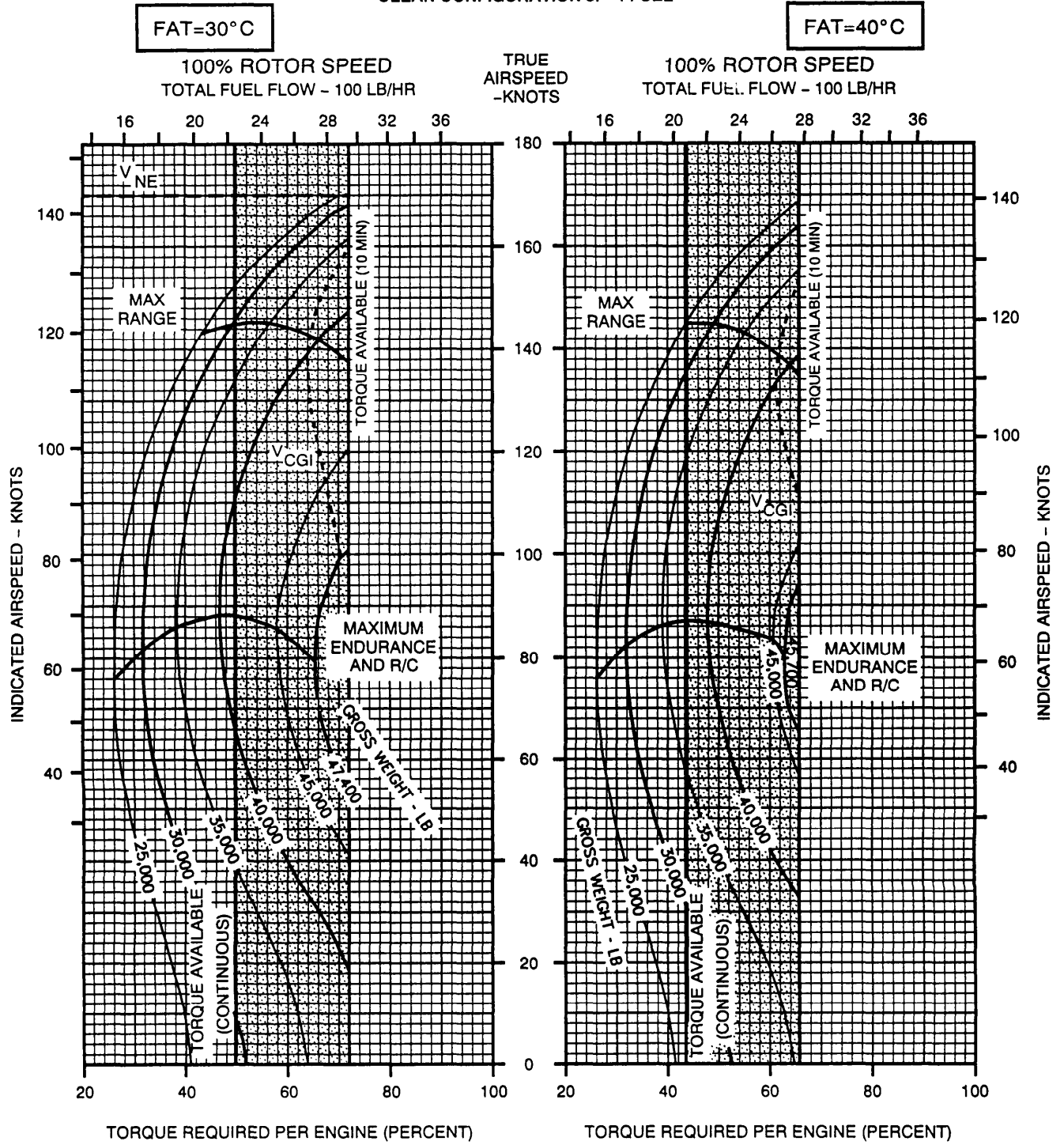
A21201

**Figure 7-47. 100% Rotor RPM, 10° and 20°C, 8,000 Feet**

**CRUISE**  
**PRESSURE ALTITUDE - 8000 FT**

**CRUISE**  
**CH-47D**  
**(2) T55-L-712**

CLEAN CONFIGURATION JP-4 FUEL



DATA BASIS: FLIGHT TEST

A21202

Figure 7-48. 100% Rotor RPM, 30°C and 40°C, 8,000 Feet



**CRUISE**

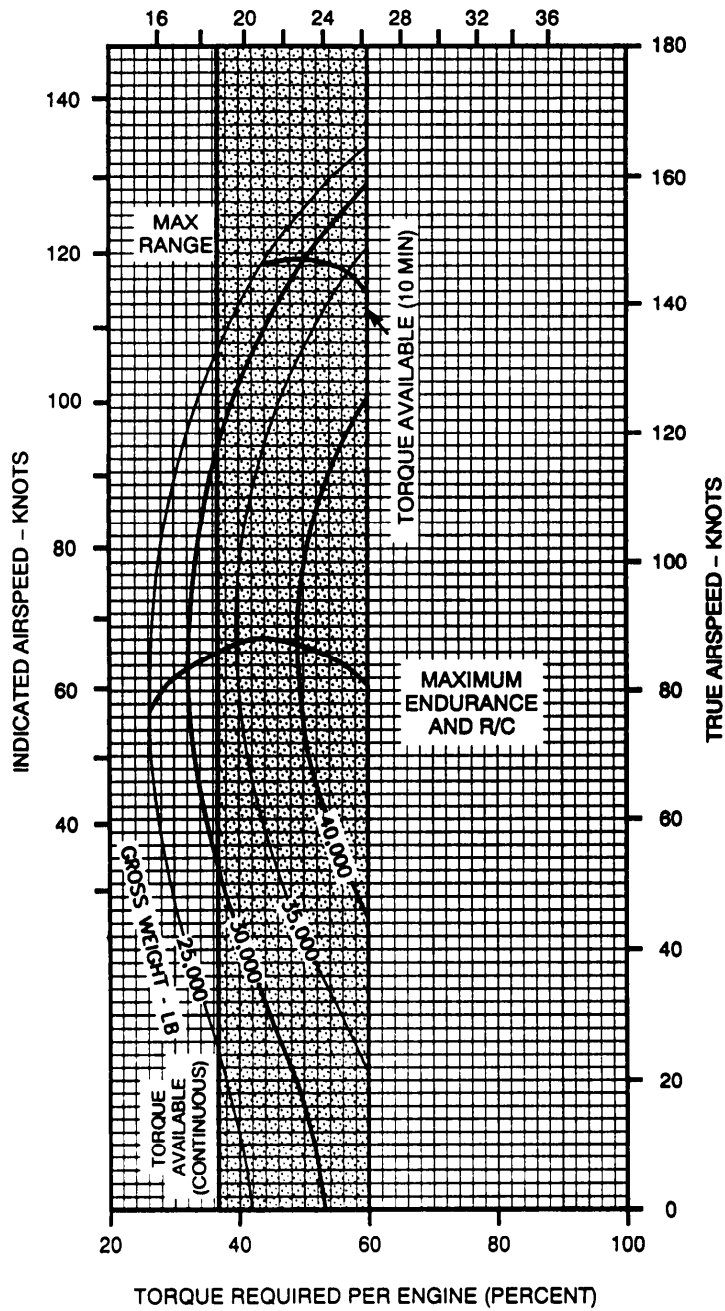
**PRESSURE ALTITUDE - 8000 FT**

**CRUISE  
CH-47D  
(2) T55-L-712**

**CLEAN CONFIGURATION JP-4 FUEL**

**FAT=50°C**

**100% ROTOR SPEED  
TOTAL FUEL FLOW - 100 LB/HR**



DATA BASIS: FLIGHT TEST

A9280

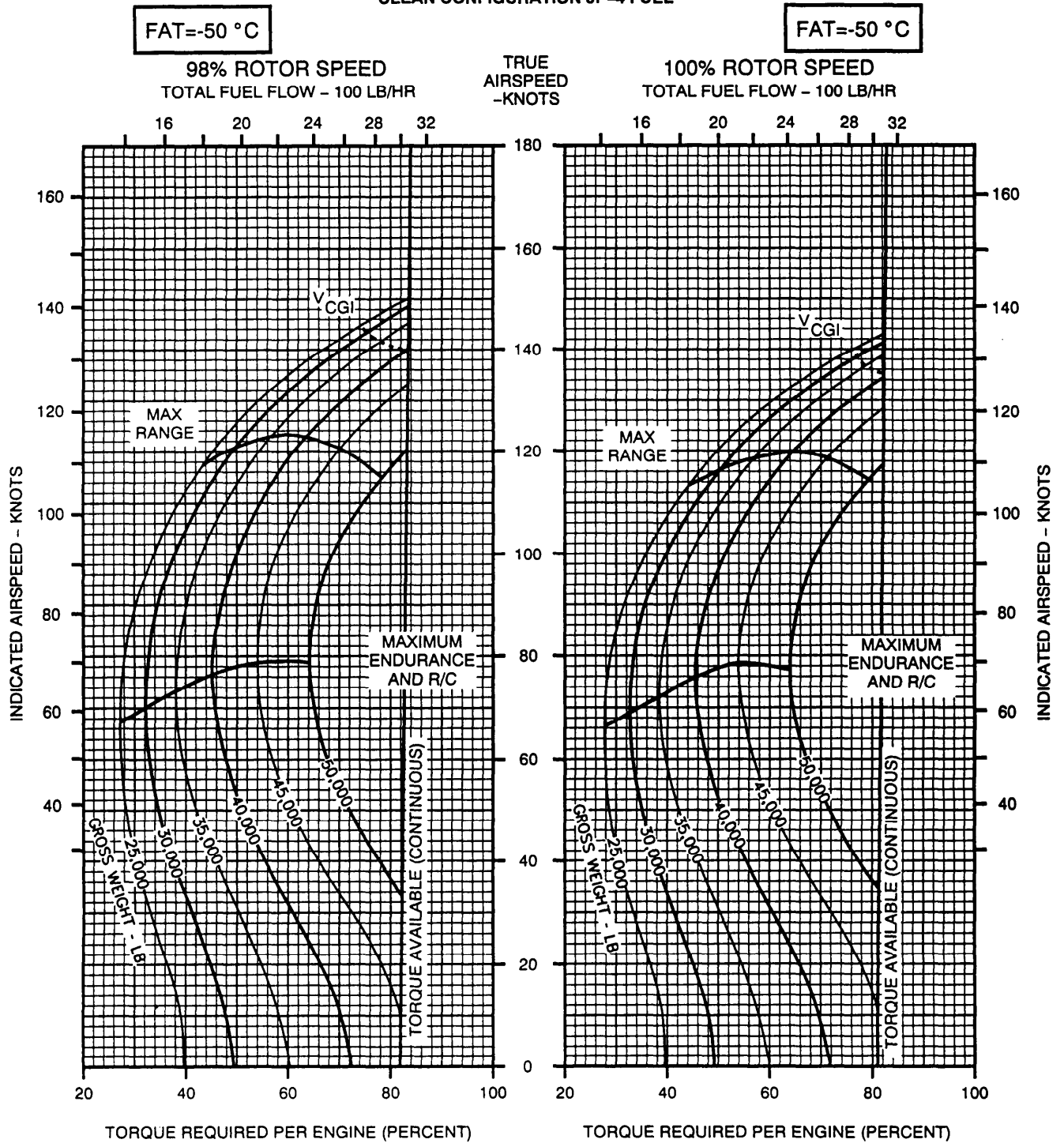
Figure 7-49. 100% Rotor RPM, 50°C, 8,000 Feet

# CRUISE

PRESSURE ALTITUDE - 10,000 FT

CRUISE  
CH-47D  
(2) T55-L-712

CLEAN CONFIGURATION JP-4 FUEL



DATA BASIS: FLIGHT TEST

A9372

Figure 7-50. 98 and 100% Rotor RPM., -50°C, 10,000 Feet

**CRUISE**

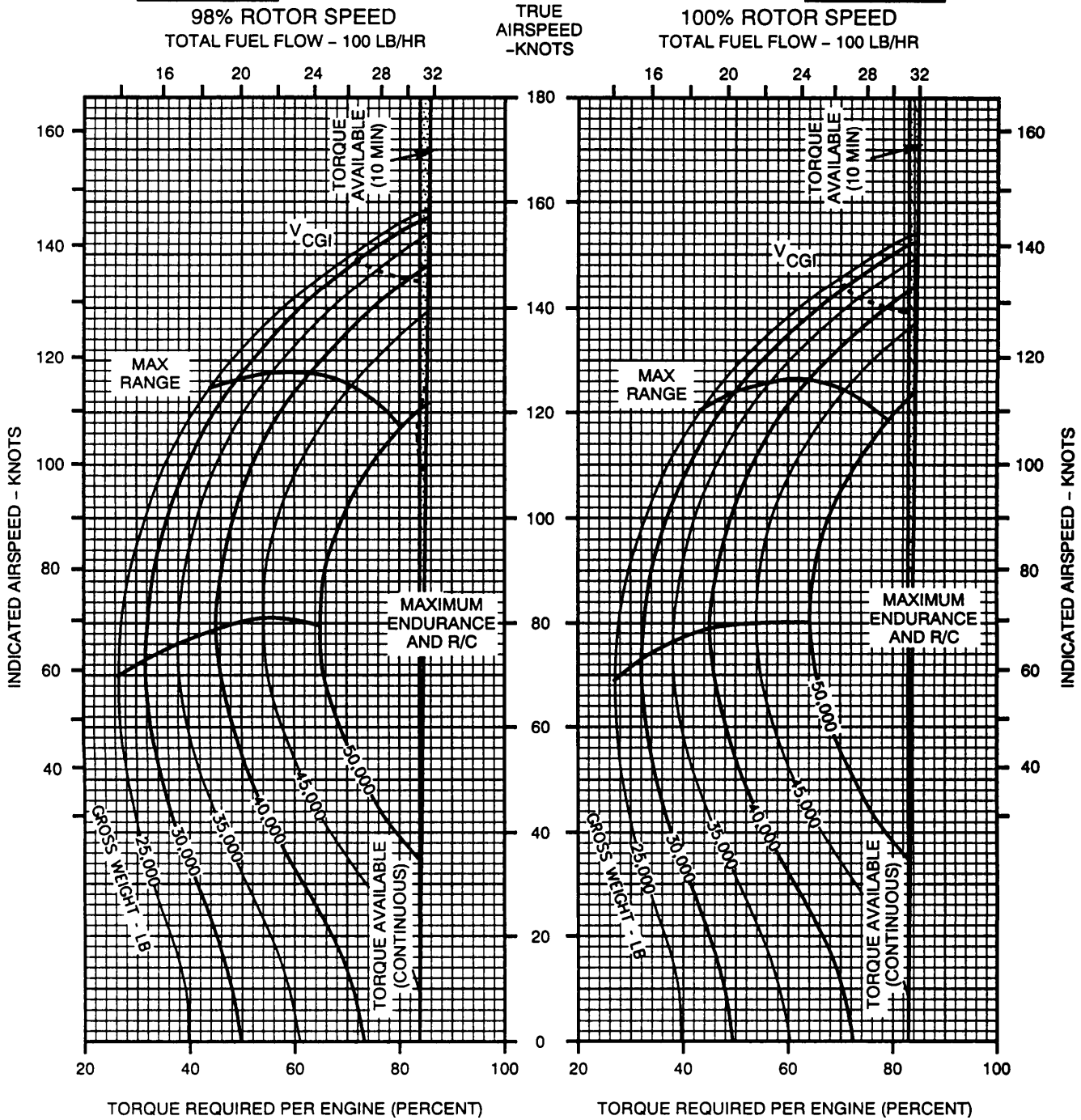
**PRESSURE ALTITUDE - 10,000 FT**

**CRUISE  
CH-47D  
(2) T55-L-712**

**CLEAN CONFIGURATION JP-4 FUEL**

**FAT=-40 °C**

**FAT=-40 °C**



DATA BASIS: FLIGHT TEST

A9373

Figure 7-51. 98 and 100% Rotor RPM, -40°C, 10,000 Feet

**CRUISE**

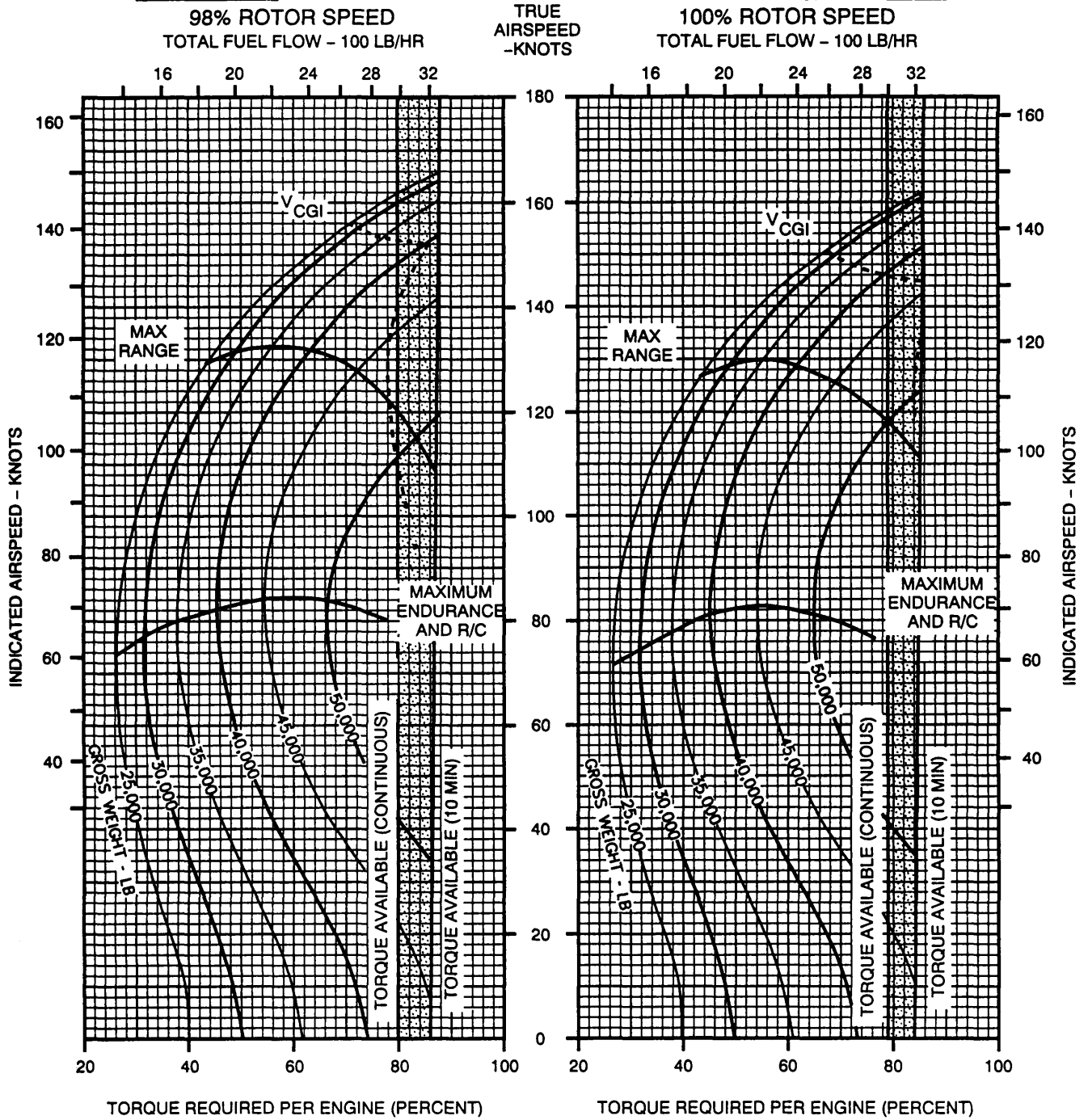
**PRESSURE ALTITUDE - 10,000 FT**

**CRUISE  
CH-47D  
(2) T55-L-712**

**CLEAN CONFIGURATION JP-4 FUEL**

**FAT=-30 °C**

**FAT=-30 °C**



**DATA BASIS: FLIGHT TEST**

A9374

*Figure 7-52. 98 and 100% Rotor RPM, -30°C, 10,000 Feet*

**CRUISE**

**PRESSURE ALTITUDE - 10,000 FT**

**CRUISE  
CH-47D  
(2) T55-L-712**

**CLEAN CONFIGURATION JP-4 FUEL**

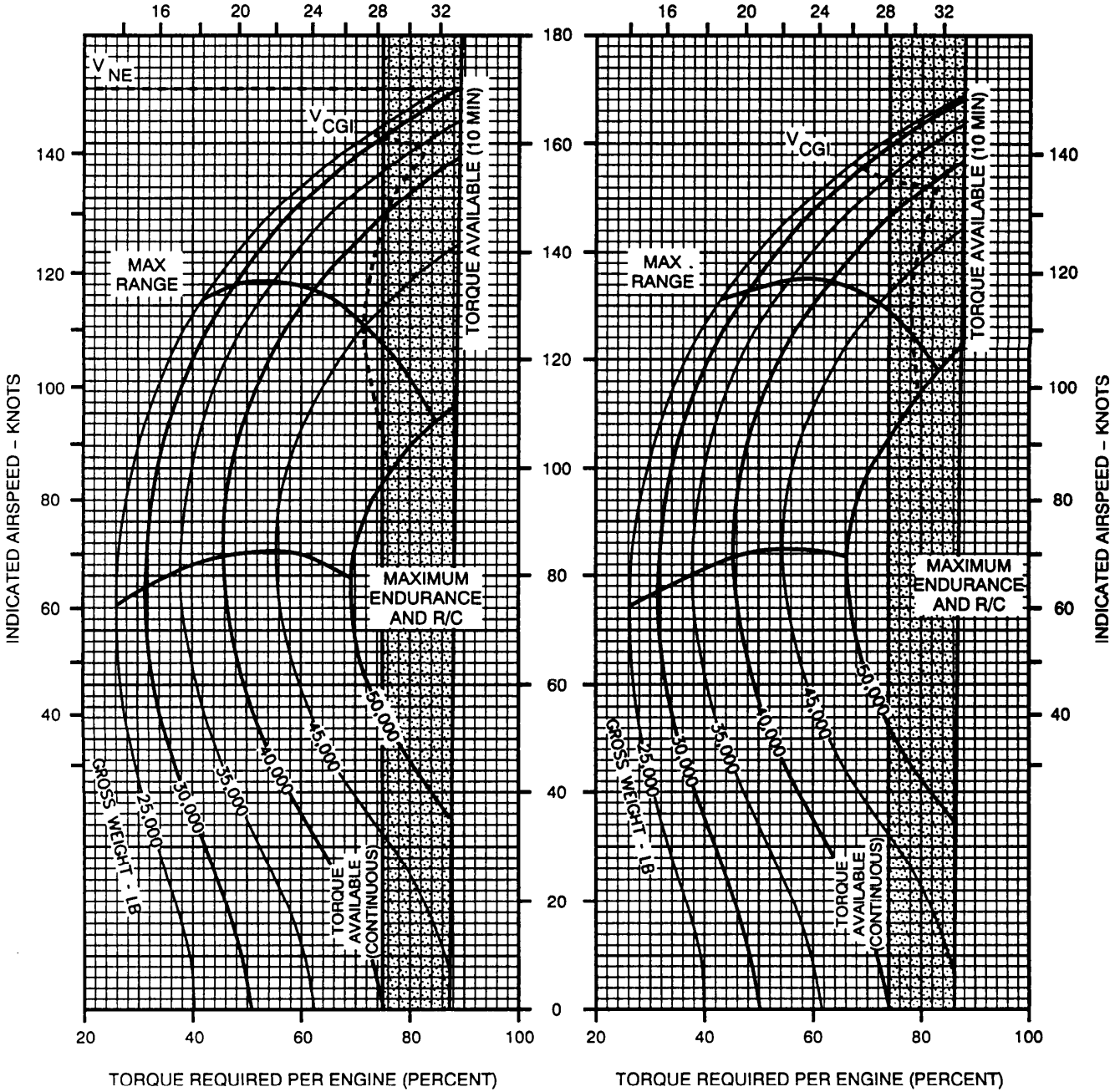
**FAT=-20 °C**

**FAT=-20 °C**

**98% ROTOR SPEED  
TOTAL FUEL FLOW - 100 LB/HR**

**TRUE  
AIRSPEED  
-KNOTS**

**100% ROTOR SPEED  
TOTAL FUEL FLOW - 100 LB/HR**



DATA BASIS: FLIGHT TEST

A21203

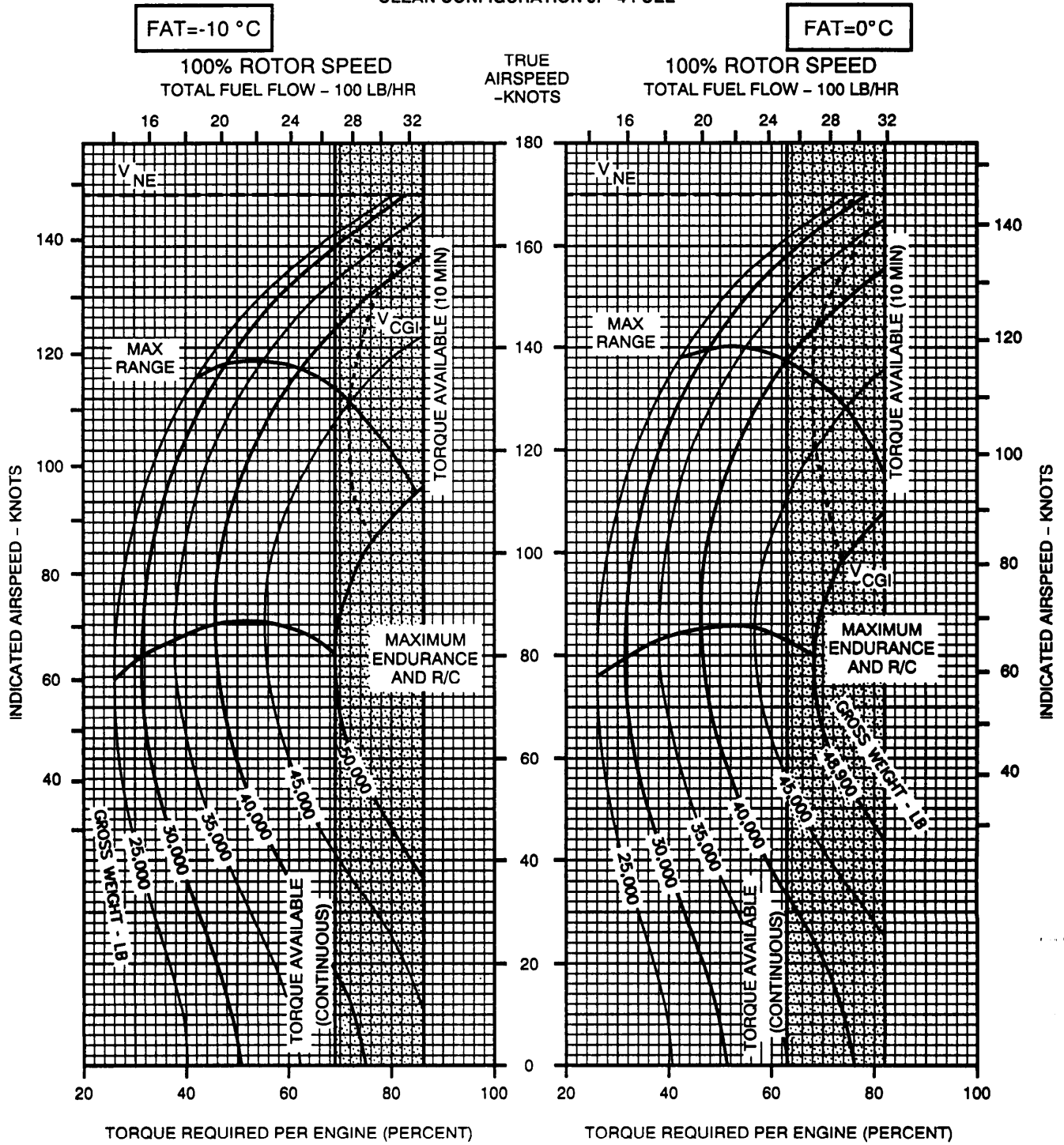
*Figure 7-53. 98 and 100% Rotor RPM, -20°C, 10,000 Feet*

**CRUISE**

**PRESSURE ALTITUDE - 10,000 FT**

**CRUISE  
CH-47D  
(2) T55-L-712**

**CLEAN CONFIGURATION JP-4 FUEL**



DATA BASIS: FLIGHT TEST

A21204

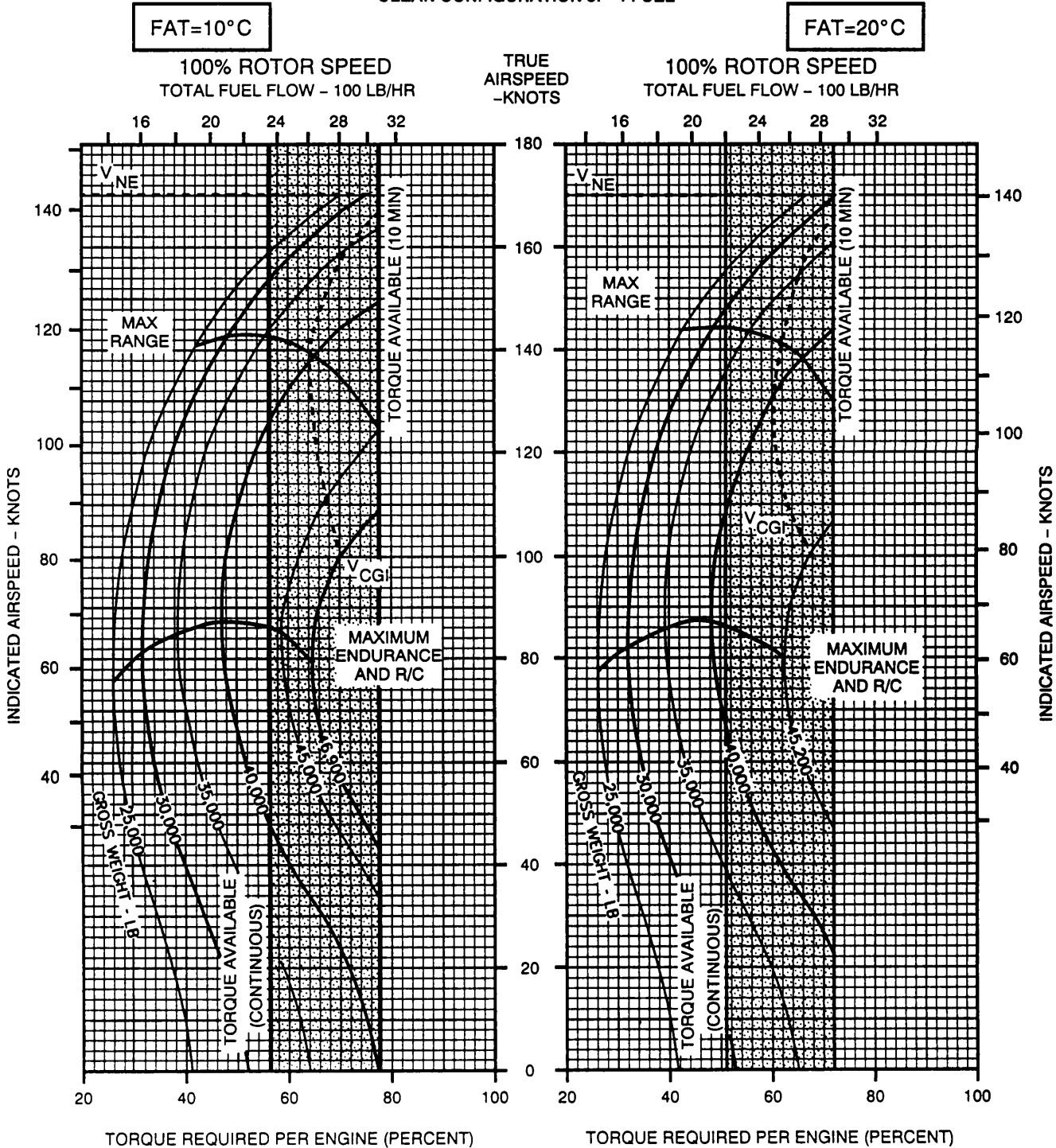
Figure 7-54. 100% Rotor RPM, -10° and 0°C, 10,000 Feet

**CRUISE**

**PRESSURE ALTITUDE - 10,000 FT**

**CRUISE  
CH-47D  
(2) T55-L-712**

**CLEAN CONFIGURATION JP-4 FUEL**



DATA BASIS: FLIGHT TEST

A21205

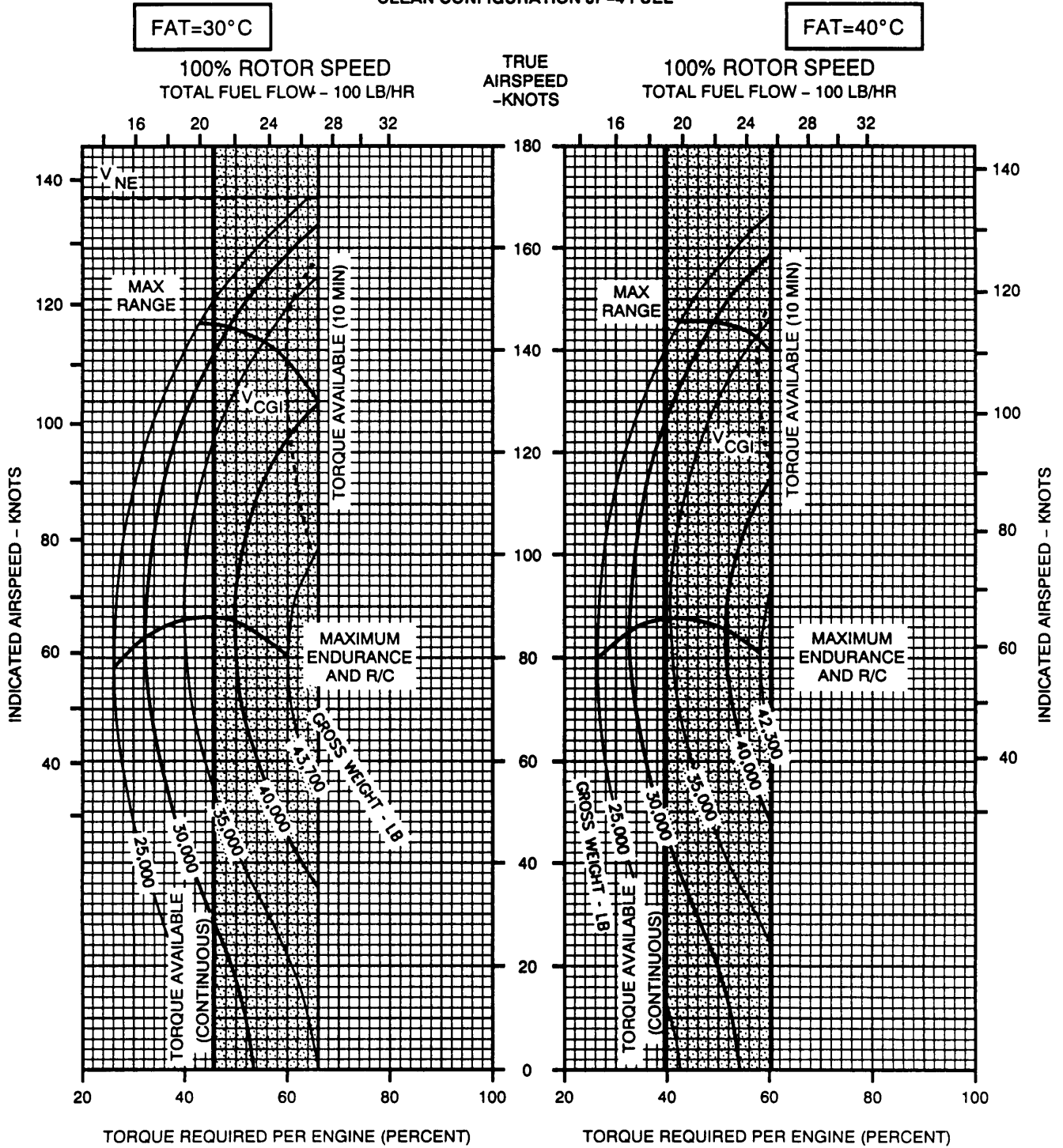
**Figure 7-55. 100% Rotor RPM, 10° and 20°C, 10,000 Feet**

**CRUISE**

**PRESSURE ALTITUDE - 10,000 FT**

**CRUISE  
CH-47D  
(2) T55-L-712**

**CLEAN CONFIGURATION JP-4 FUEL**



DATA BASIS: FLIGHT TEST

A21206

Figure 7-56. 100% Rotor RPM, 30° and 40°C, 10,000 Feet



# CRUISE

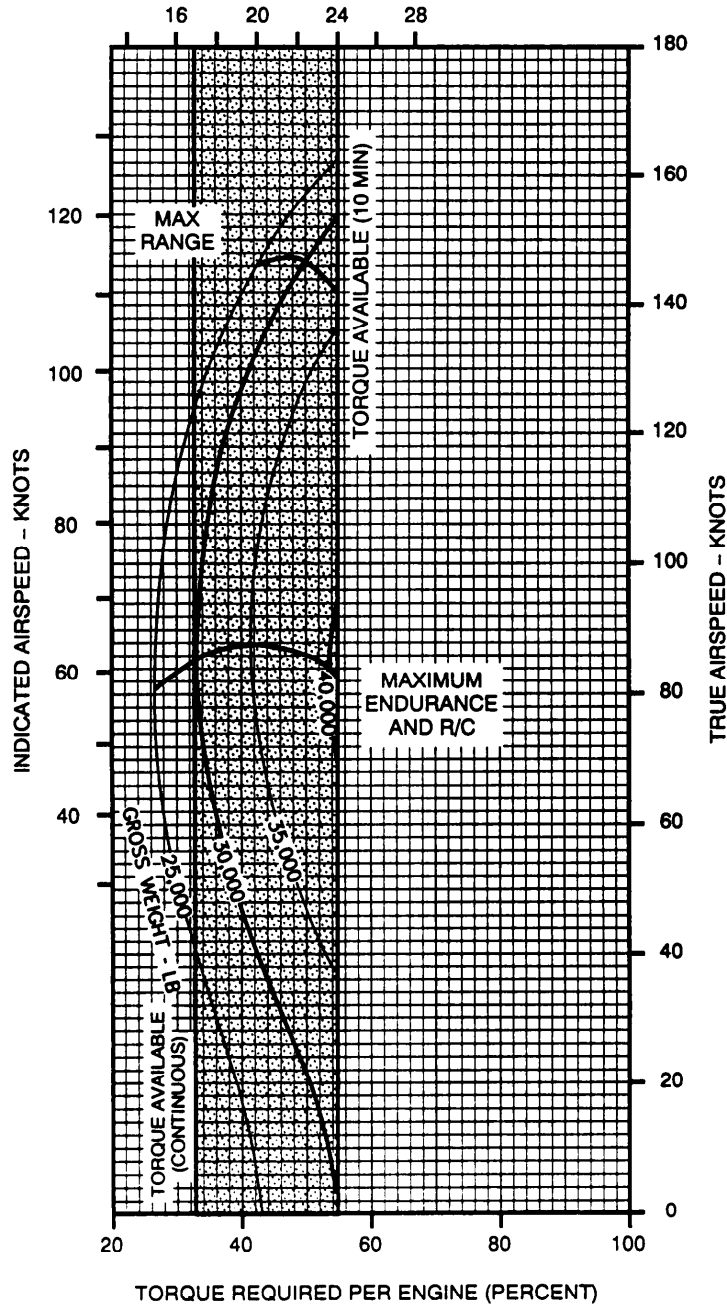
PRESSURE ALTITUDE - 10,000 FT

CRUISE  
CH-47D  
(2) T55-L-712

CLEAN CONFIGURATION JP-4 FUEL  
100% ROTOR RPM

FAT=50°C

100% ROTOR SPEED  
TOTAL FUEL FLOW - 100 LB/HR



DATA BASIS: FLIGHT TEST

A9409

Figure 7-57. 100% Rotor RPM, 50°C, 10,000 Feet

CRUISE

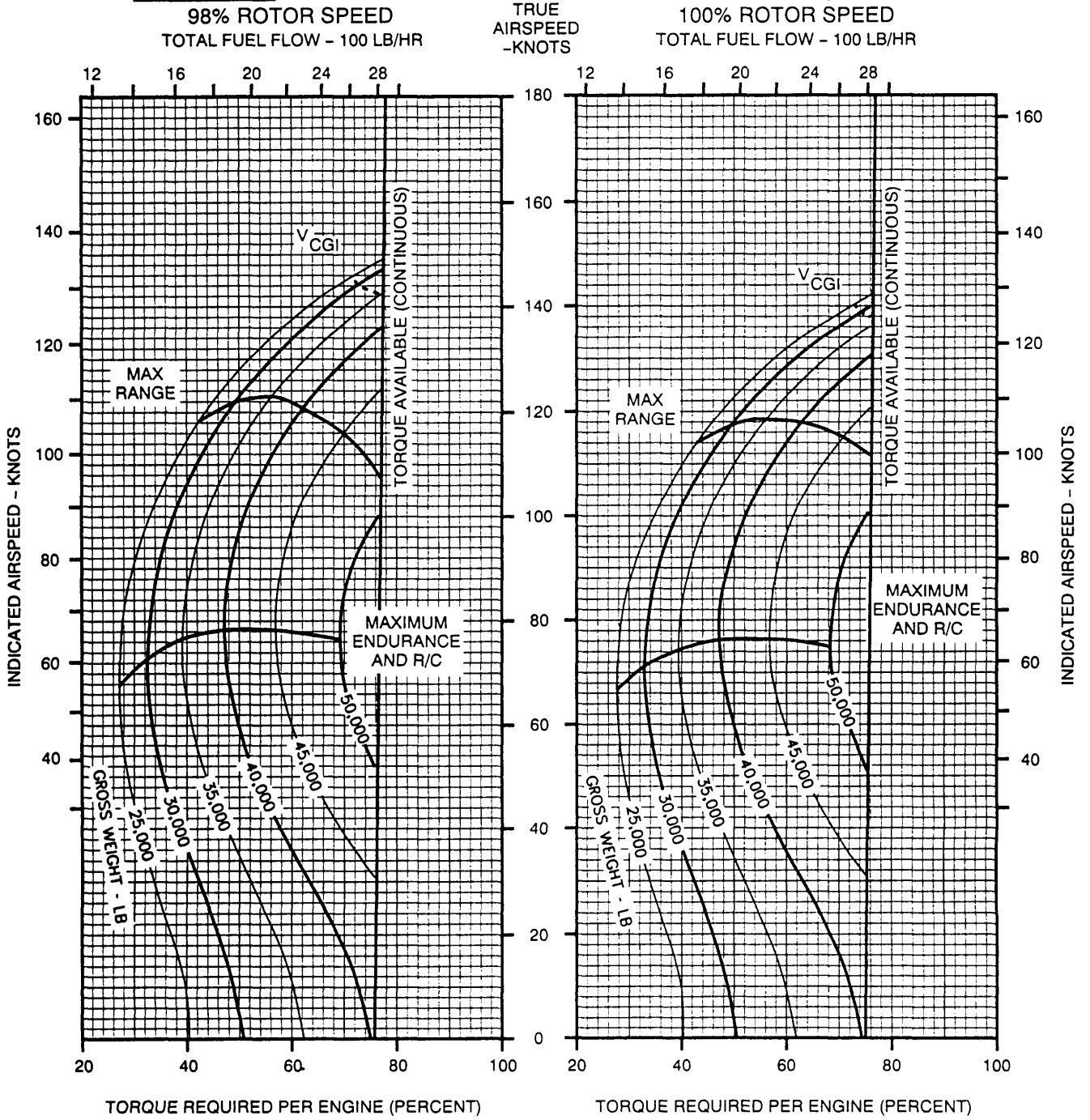
PRESSURE ALTITUDE - 12,000 FT

CRUISE  
CH-47D  
(2) T55-L-712

CLEAN CONFIGURATION JP-4 FUEL

FAT=-50 °C

FAT=-50 °C



DATA BASIS: FLIGHT TEST

A9404

Figure 7-58. 98 and 100% Rotor RPW, -50°C, 12,000 Feet

**CRUISE**

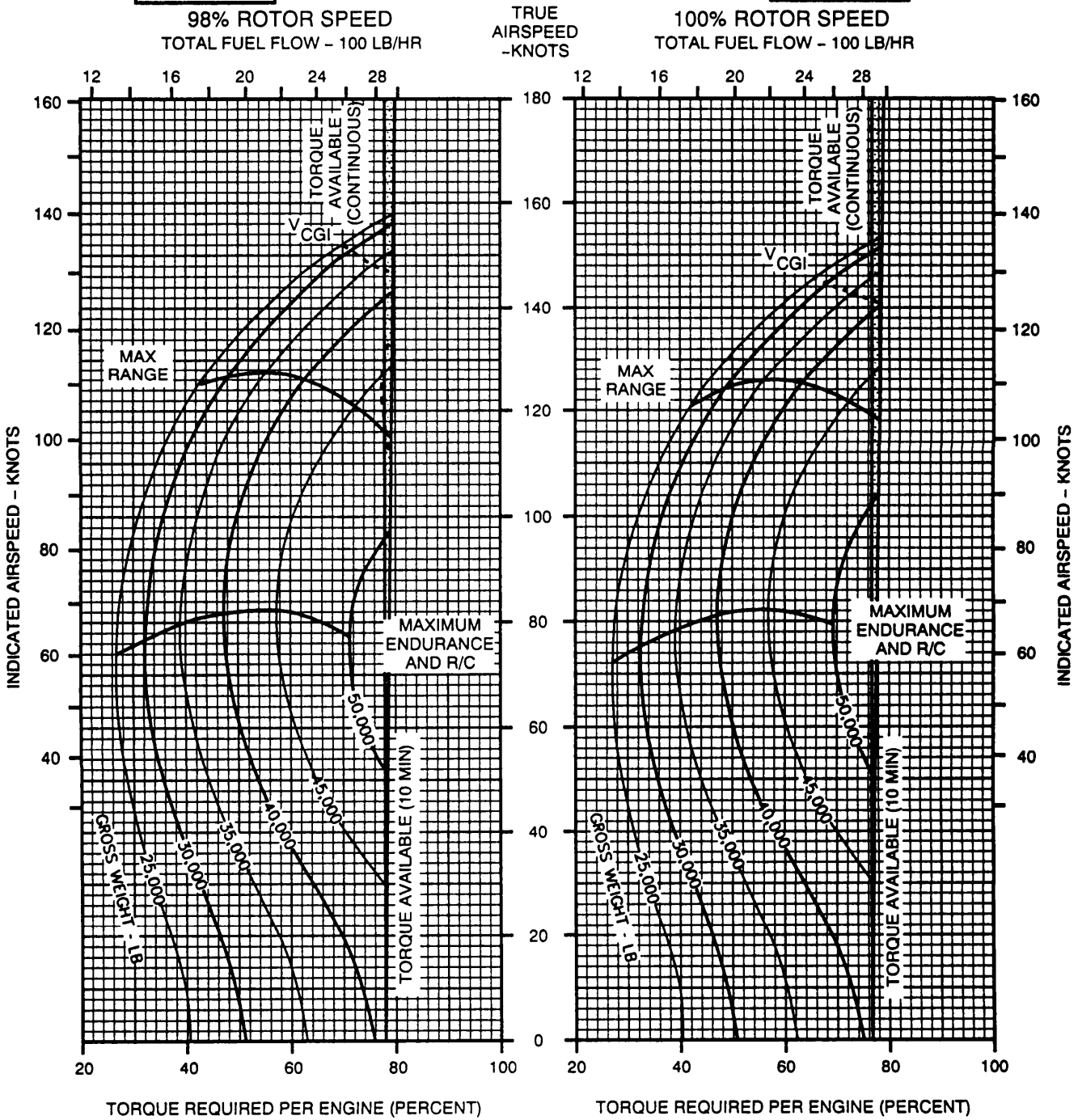
**PRESSURE ALTITUDE - 12,000 FT**

**CRUISE  
CH-47D  
(2) T55-L-712**

**CLEAN CONFIGURATION JP-4 FUEL**

**FAT=-40 °C**

**FAT=-40 °C**



DATA BASIS: FLIGHT TEST

A9410

Figure 7-59. 98 and 100% Rotor RPM, -4°C, 12,000 Feet

**CRUISE**

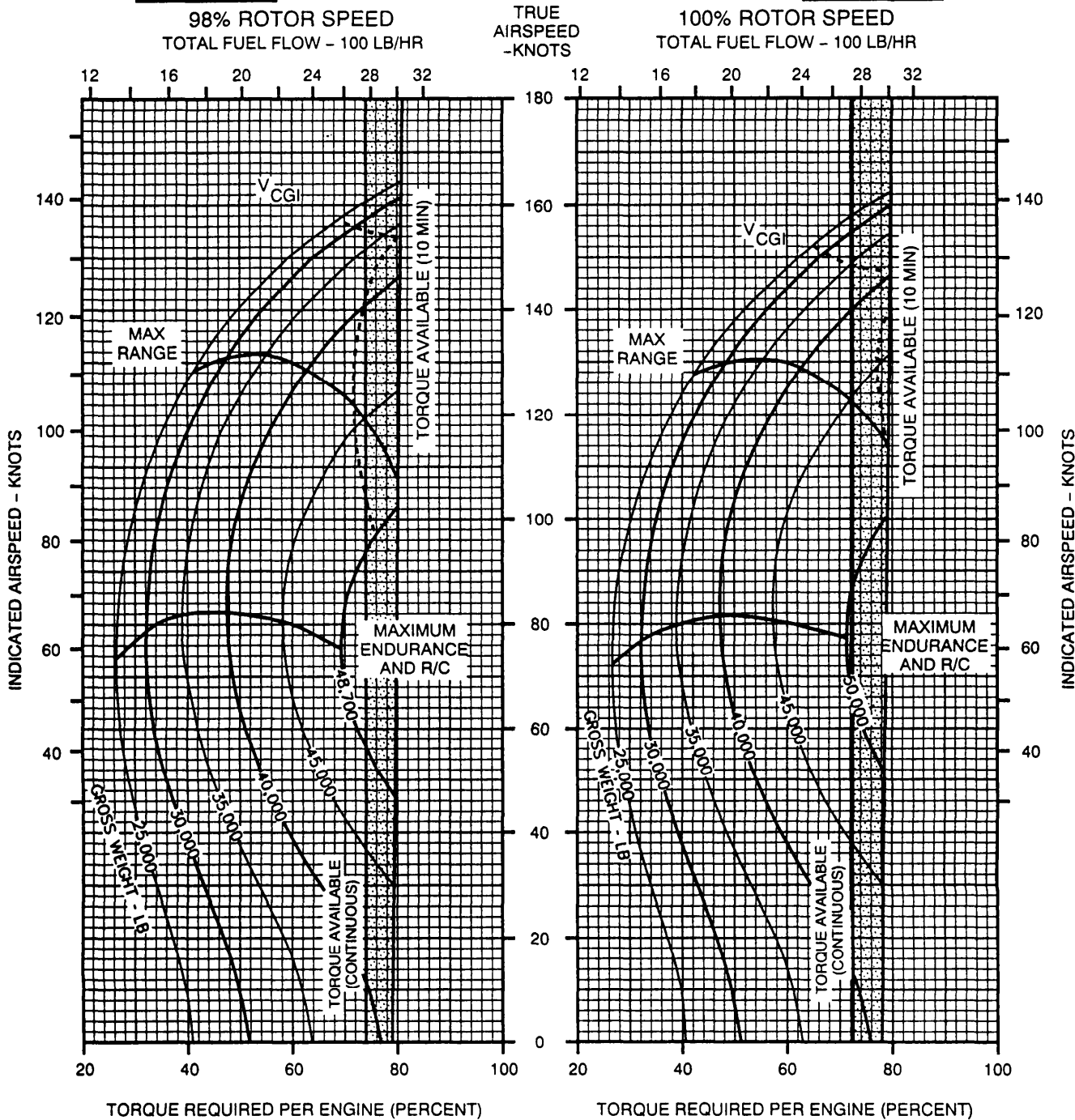
**PRESSURE ALTITUDE - 12,000 FT**

**CRUISE  
CH-47D  
(2) T55-L-712**

CLEAN CONFIGURATION JP-4 FUEL

**FAT=-30 °C**

**FAT=-30 °C**



DATA BASIS: FLIGHT TEST

A9411

Figure 7-60. 98 and 100% Rotor RPM, -30°C, 12,000 Feet

**CRUISE**

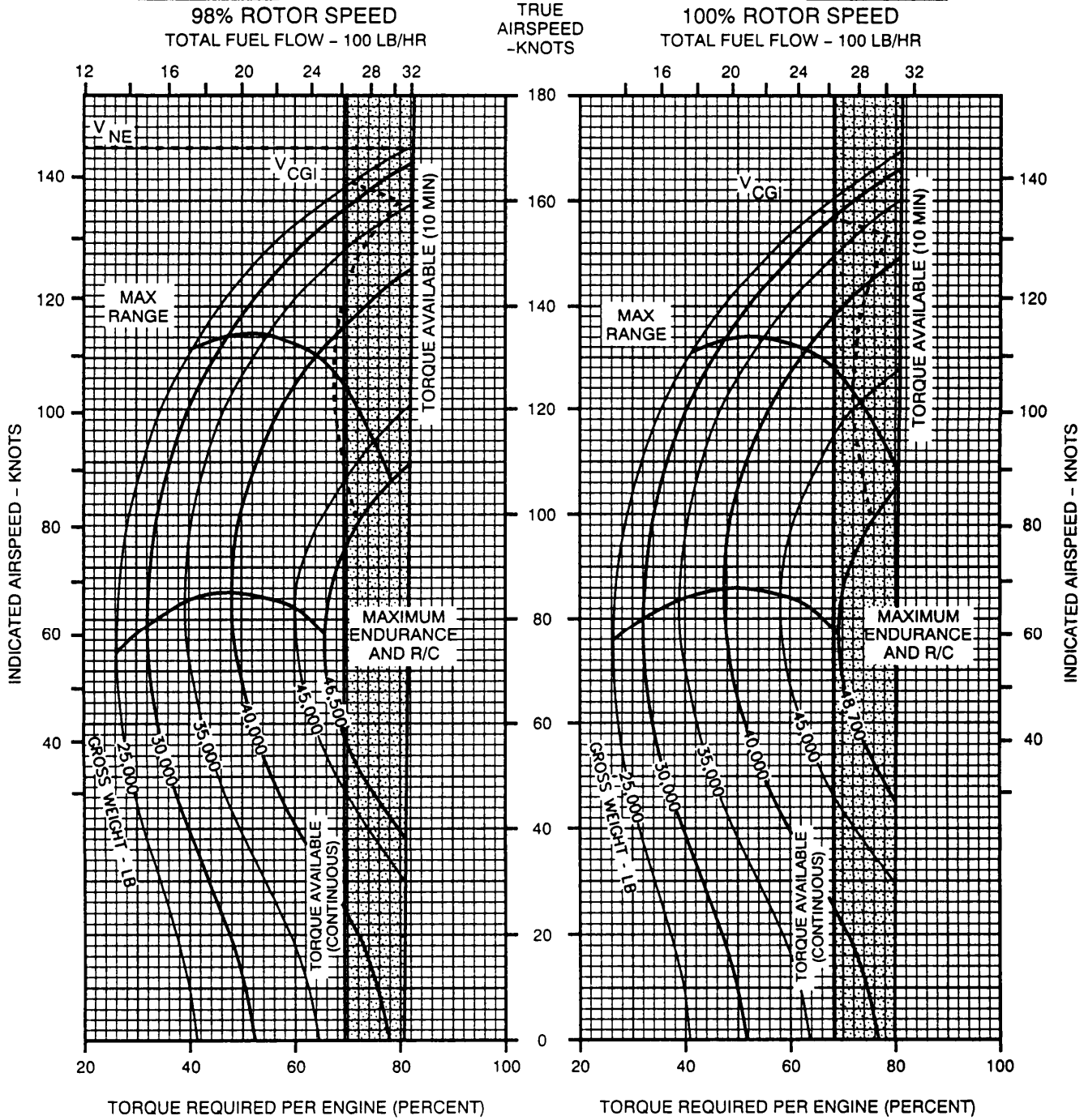
**PRESSURE ALTITUDE - 12,000 FT**

**CRUISE  
CH-47D  
(2) T55-L-712**

**CLEAN CONFIGURATION JP-4 FUEL**

**FAT=-20 °C**

**FAT=-20 °C**



DATA BASIS: FLIGHT TEST

A21207

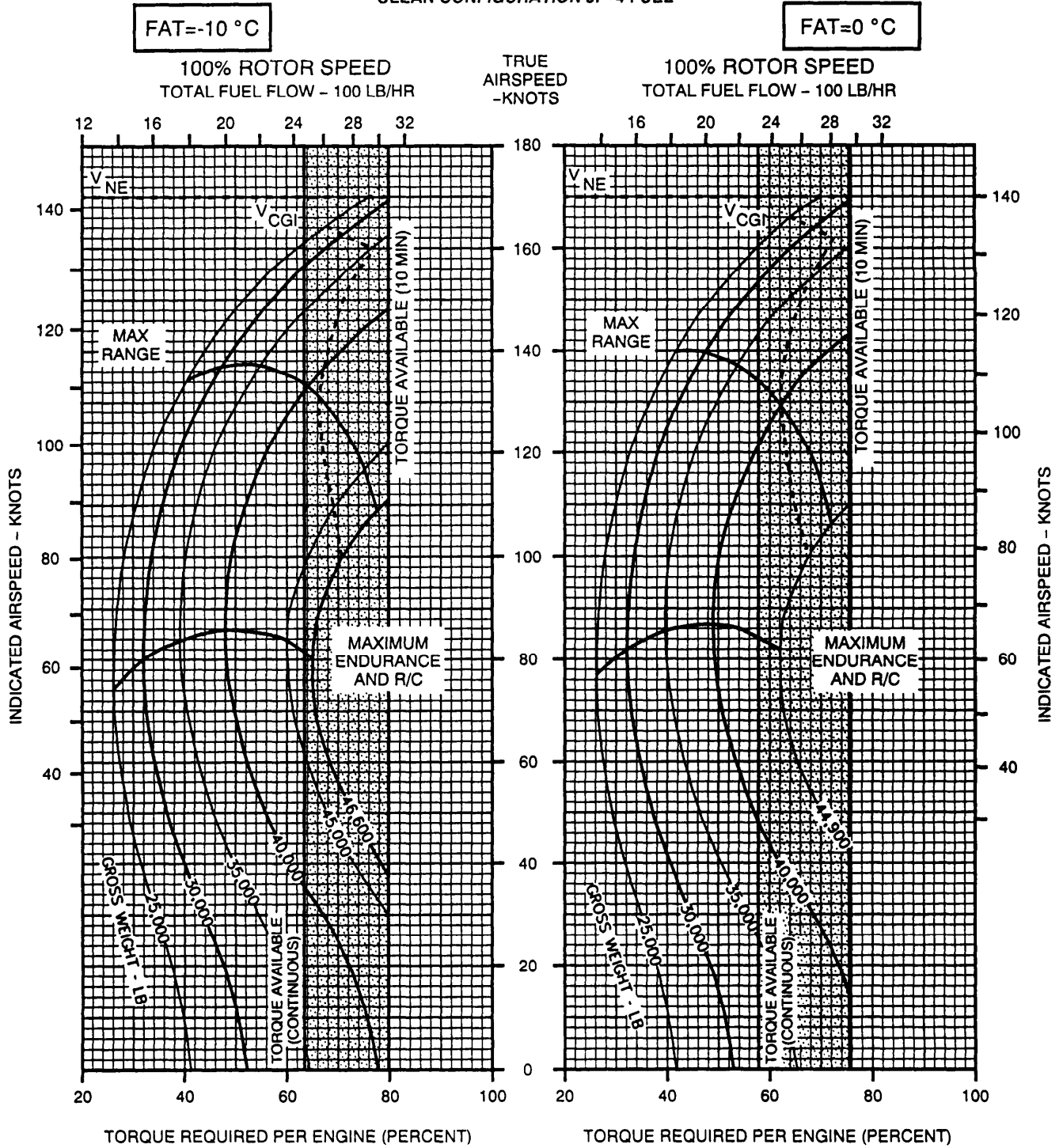
**Figure 7-61. 98 and 100% Rotor RPM, -20°C, 12,000 Feet**

CRUISE

PRESSURE ALTITUDE - 12,000 FT

CRUISE  
CH-47D  
(2) T55-L-712

CLEAN CONFIGURATION JP-4 FUEL



DATA BASIS: FLIGHT TEST

A21208

Figure 7-62. 100% Rotor RPM, -10° and 0°C, 12,000 Feet

**CRUISE**

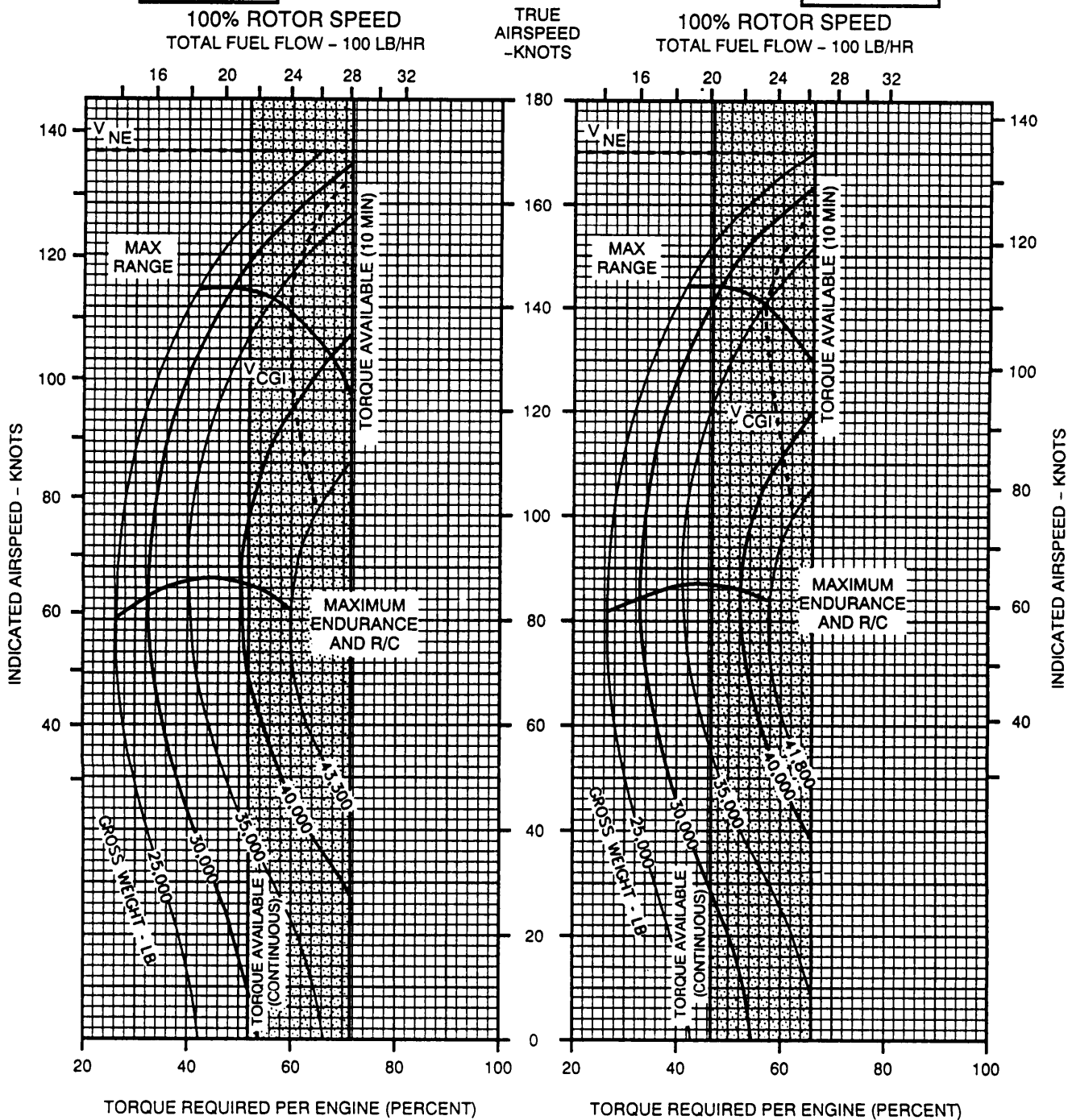
**PRESSURE ALTITUDE - 12,000 FT**

**CRUISE  
CH-47D  
(2) T55-L-712**

**CLEAN CONFIGURATION JP-4 FUEL**

**FAT=10°C**

**FAT=20°C**



DATA BASIS: FLIGHT TEST

A21209

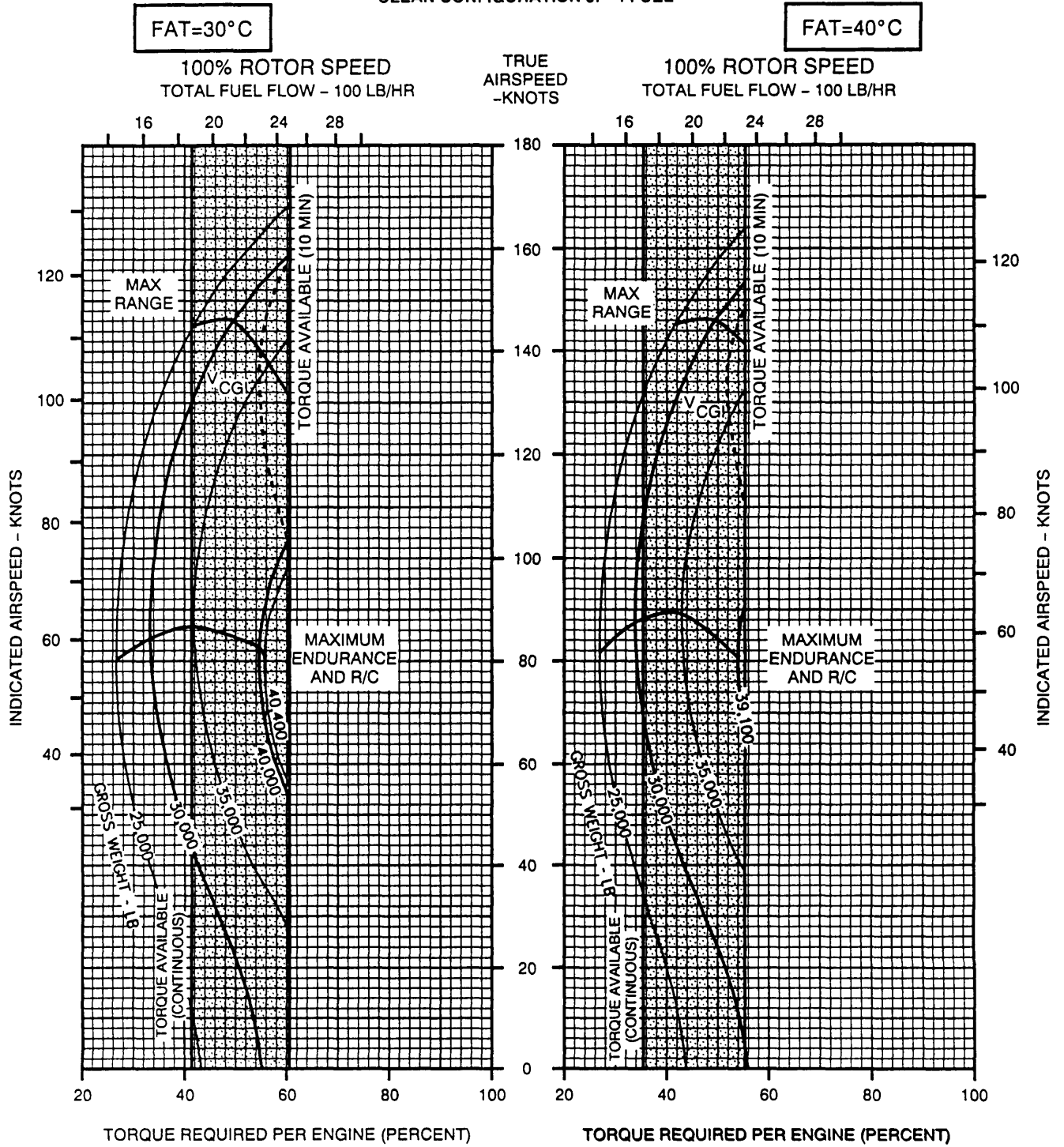
**Figure 7-63. 100% Rotor RPM, 10° and 20° 12,000 Feet**

**CRUISE**

**PRESSURE ALTITUDE - 12,000 FT**

**CRUISE  
CH-47D  
(2) T55-L-712**

**CLEAN CONFIGURATION JP-4 FUEL**



DATA BASIS: FLIGHT TEST

A21210

**Figure 7-64. 100% Rotor PM, 30° and 40°C 12,000 Feet**



# CRUISE

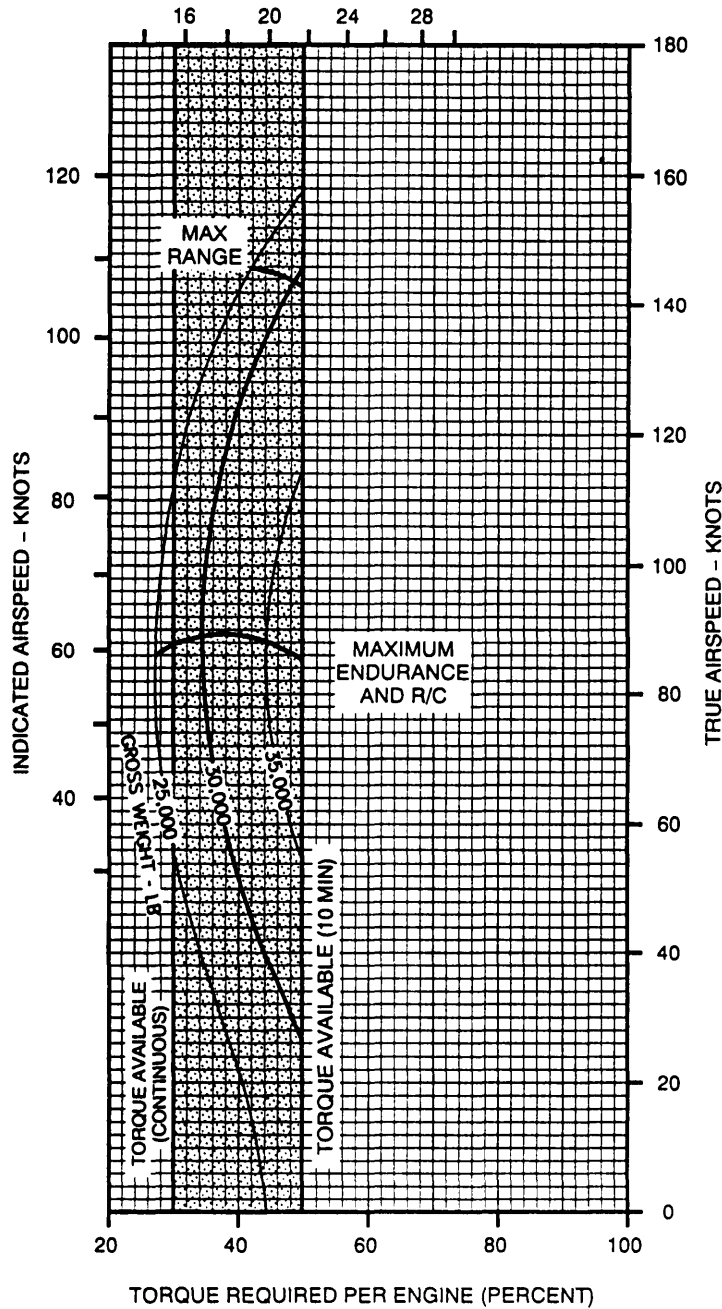
PRESSURE ALTITUDE - 12,000 FT

CRUISE  
CH-47D  
(2) T55-L-712

CLEAN CONFIGURATION JP-4 FUEL

FAT=50°C

100% ROTOR SPEED  
TOTAL FUEL FLOW - 100 LB/HR



DATA BASIS: FLIGHT TEST

A9412

Figure 7-65. 100% Rotor RPM, 5°C, 12,000 Feet

**CRUISE**

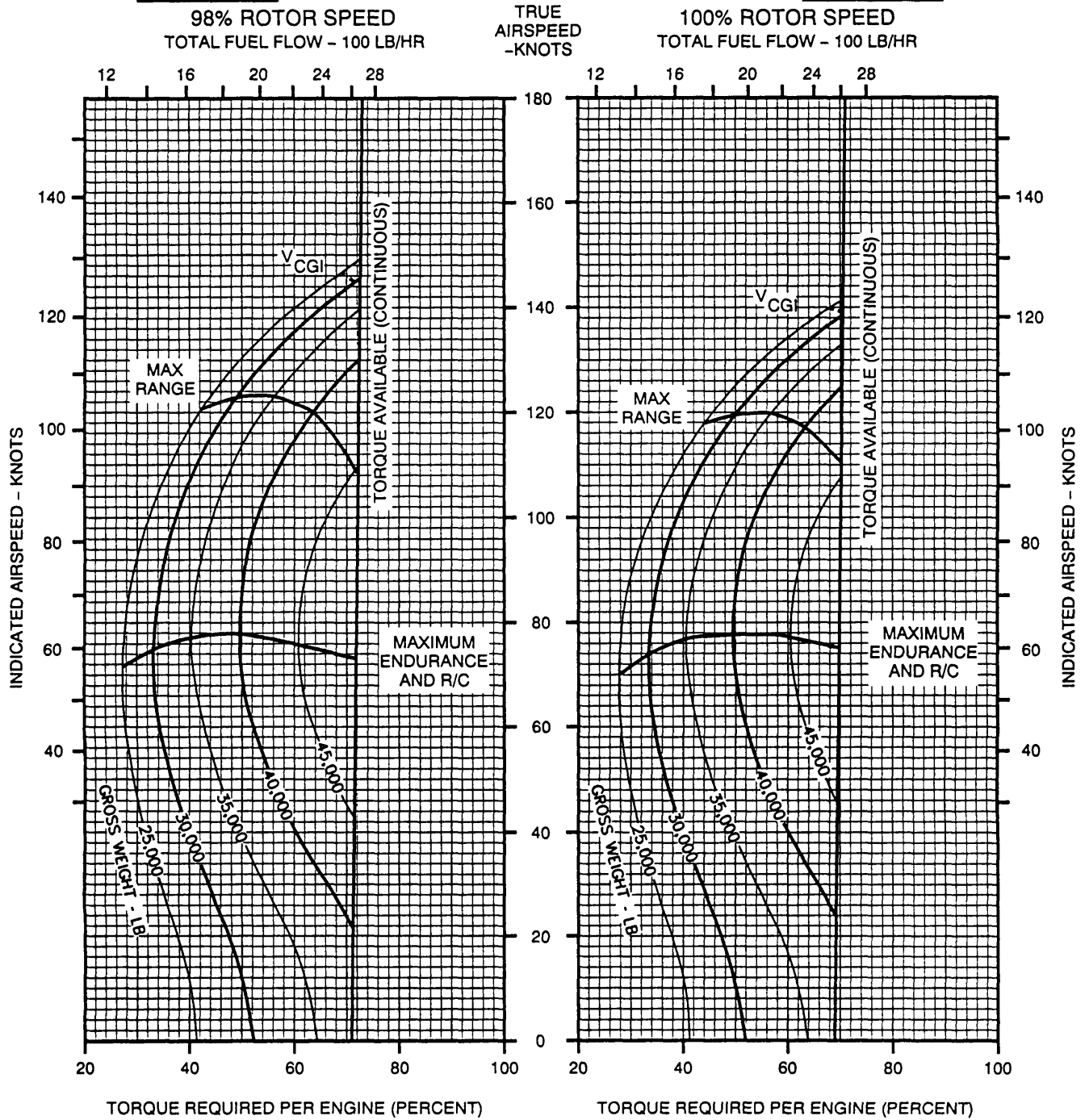
**PRESSURE ALTITUDE - 14,000 FT**

**CRUISE  
CH-47D  
(2) T55-L-712**

**CLEAN CONFIGURATION JP-4 FUEL**

**FAT=-50 °C**

**FAT=-50 °C**



DATA BASIS: FLIGHT TEST

A9413

Figure 7-66. 98 and 100% Rotor RPM, -50°C, 14,000 Feet

**CRUISE**

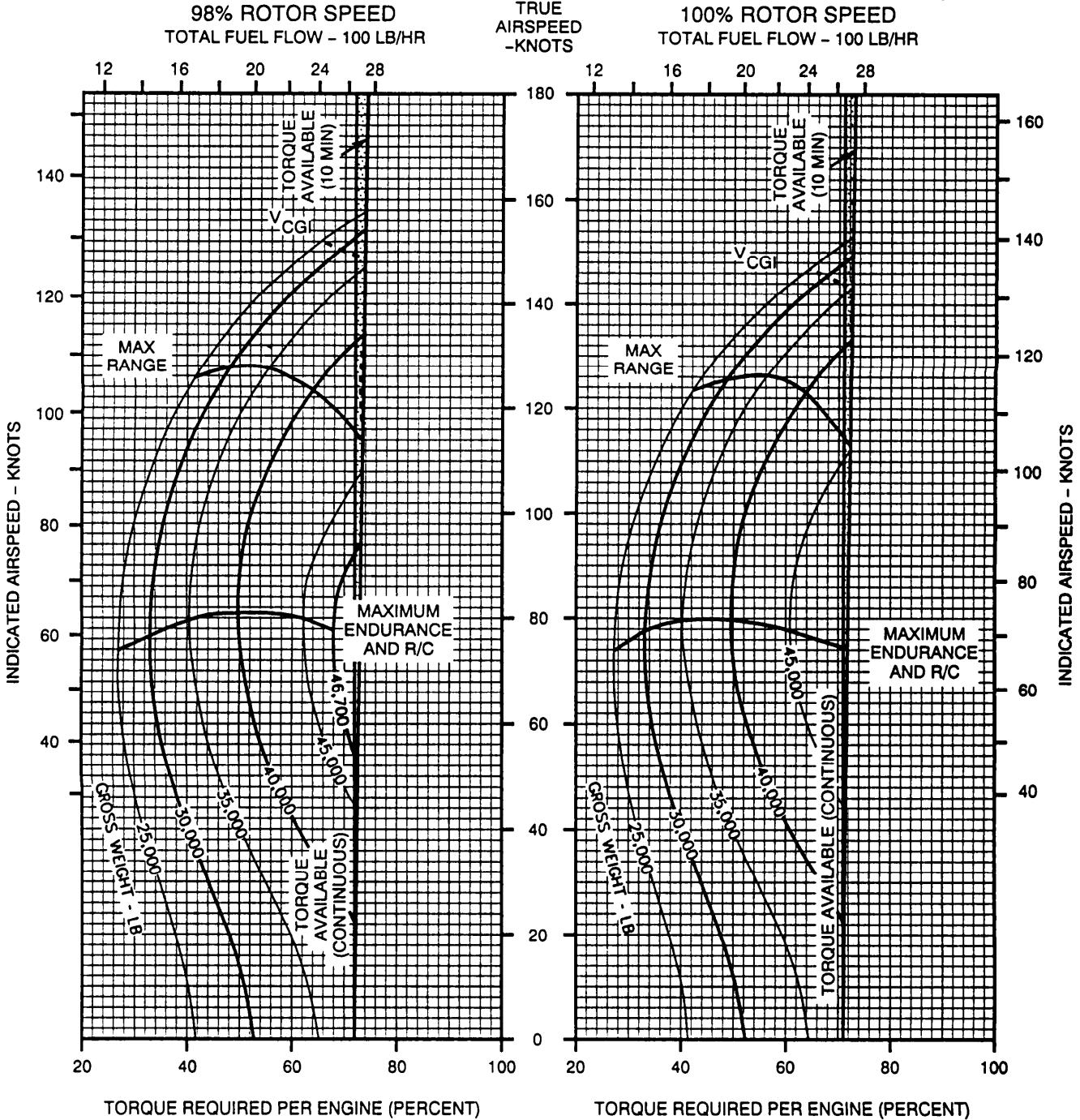
**PRESSURE ALTITUDE - 14,000 FT**

**CRUISE  
CH-47D  
(2) T55-L-712**

**CLEAN CONFIGURATION JP-4 FUEL**

**FAT=-40 °C**

**FAT=-40 °C**



DATA BASIS: FLIGHT TEST

A9414

Figure 7-67. 98 and 100% Rotor RPM, -40°C, 14,000 Feet

**CRUISE**

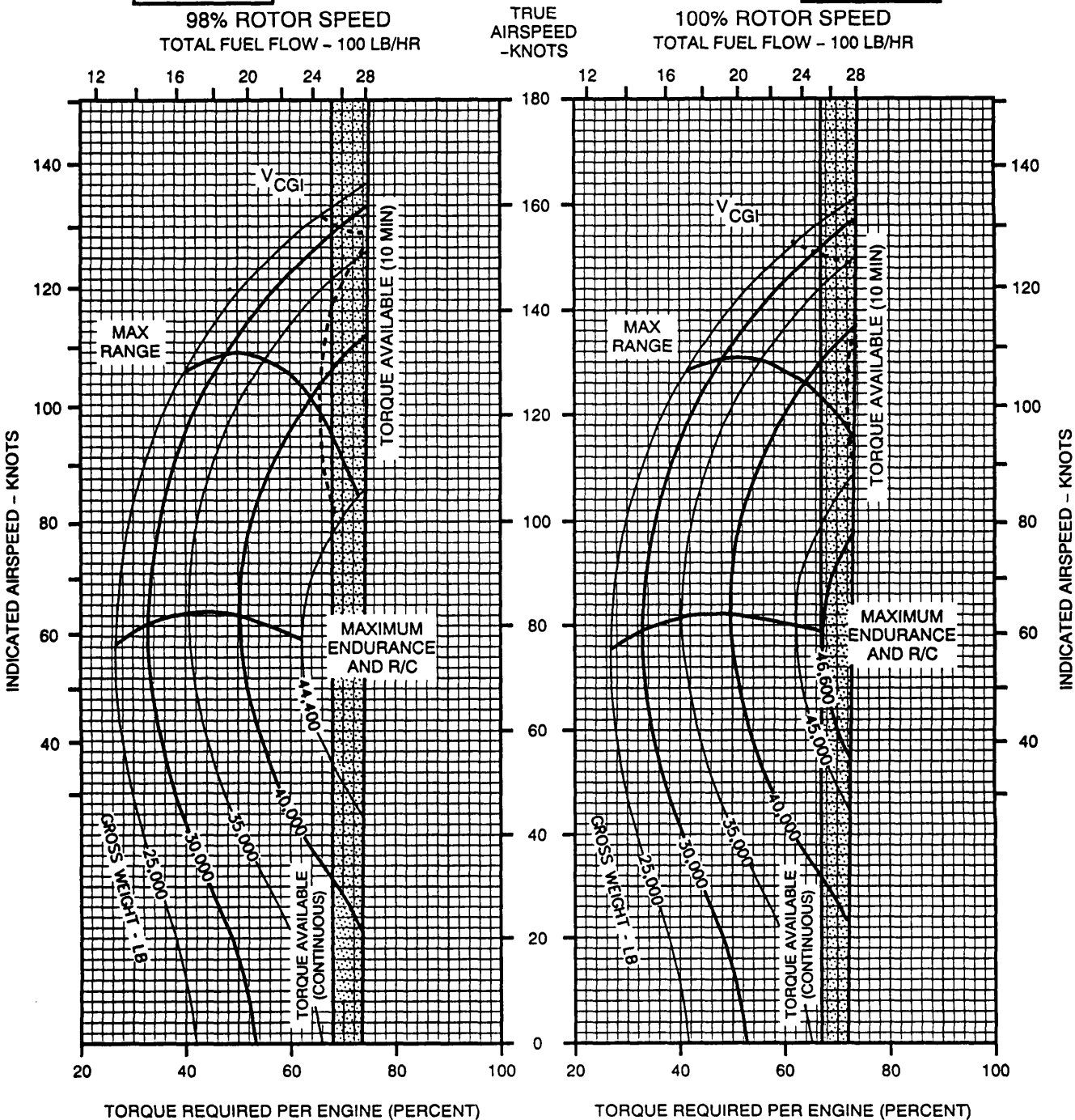
**PRESSURE ALTITUDE - 14,000 FT**

**CRUISE  
CH-47D  
(2) T55-L-712**

**CLEAN CONFIGURATION JP-4 FUEL**

**FAT=-30 °C**

**FAT=-30 °C**



**DATA BASIS: FLIGHT TEST**

**A9415**

**Figure 7-68. 98 and 100% Rotor RPM, -30°C, 14,000 Feet**

**CRUISE**

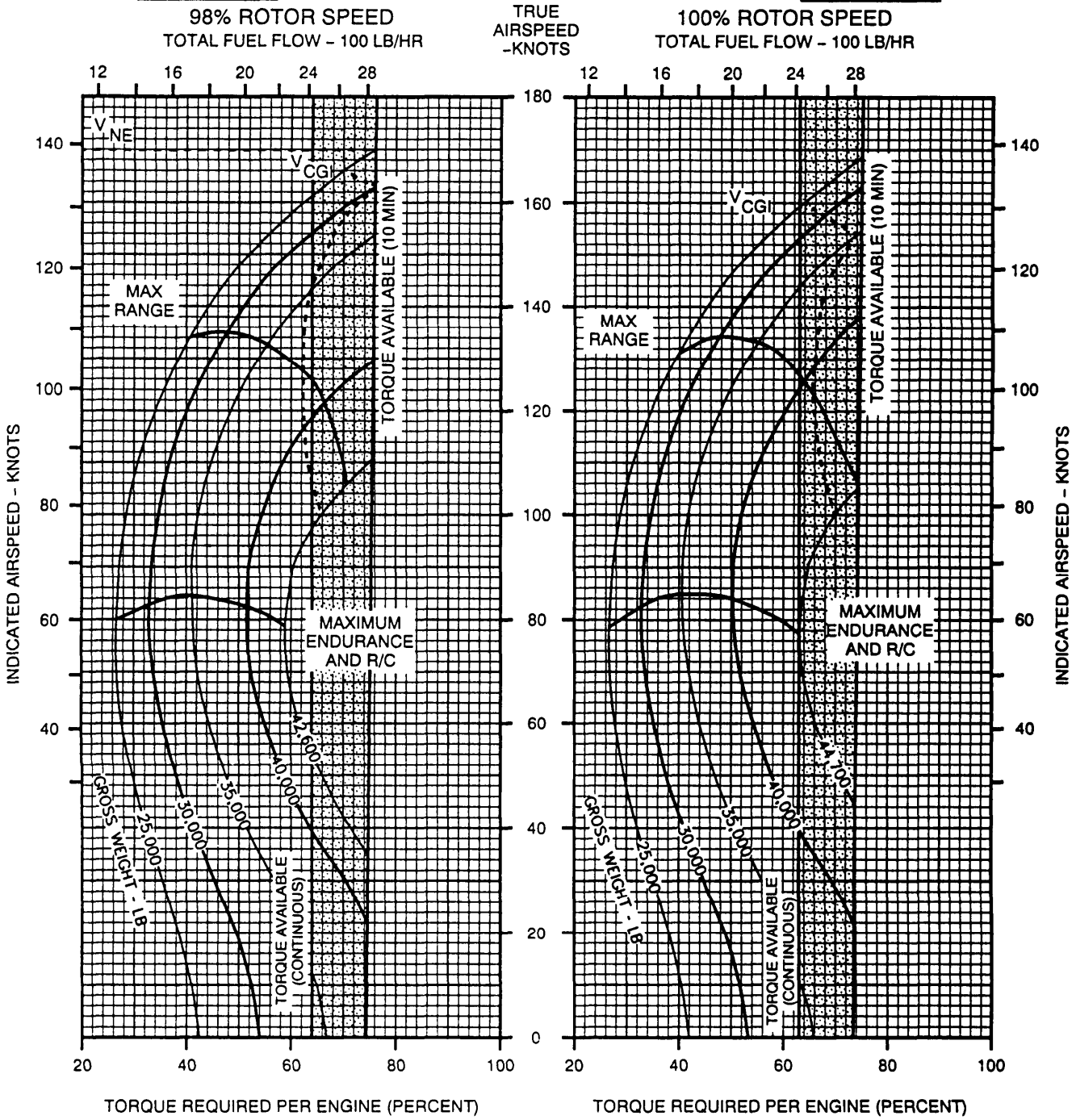
**PRESSURE ALTITUDE - 14,000 FT**

**CRUISE  
CH-47D  
(2) T55-L-712**

**CLEAN CONFIGURATION JP-4 FUEL**

**FAT=-20 °C**

**FAT=-20 °C**



DATA BASIS: FLIGHT TEST

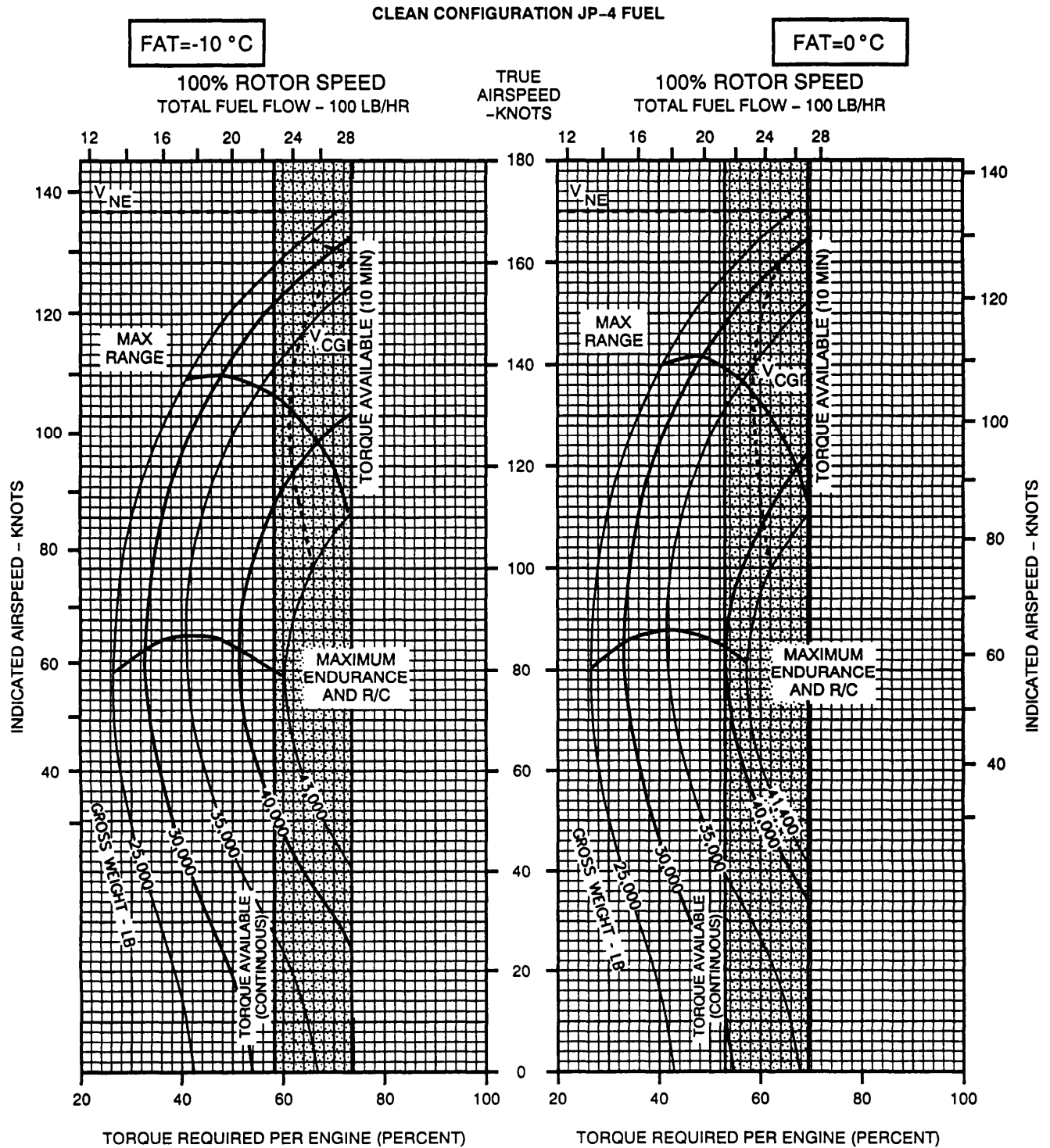
A19321

**Figure 7-69. 98 and 100% Rotor RPM, -20°C, 14,000 Feet**

**CRUISE**

**PRESSURE ALTITUDE - 14,000 FT**

**CRUISE  
CH-47D  
(2) T55-L-712**



DATA BASIS: FLIGHT TEST

A19322

Figure 7-70. 100% Rotor RPM, -10° and 0°C, 14,000 Feet

**CRUISE**

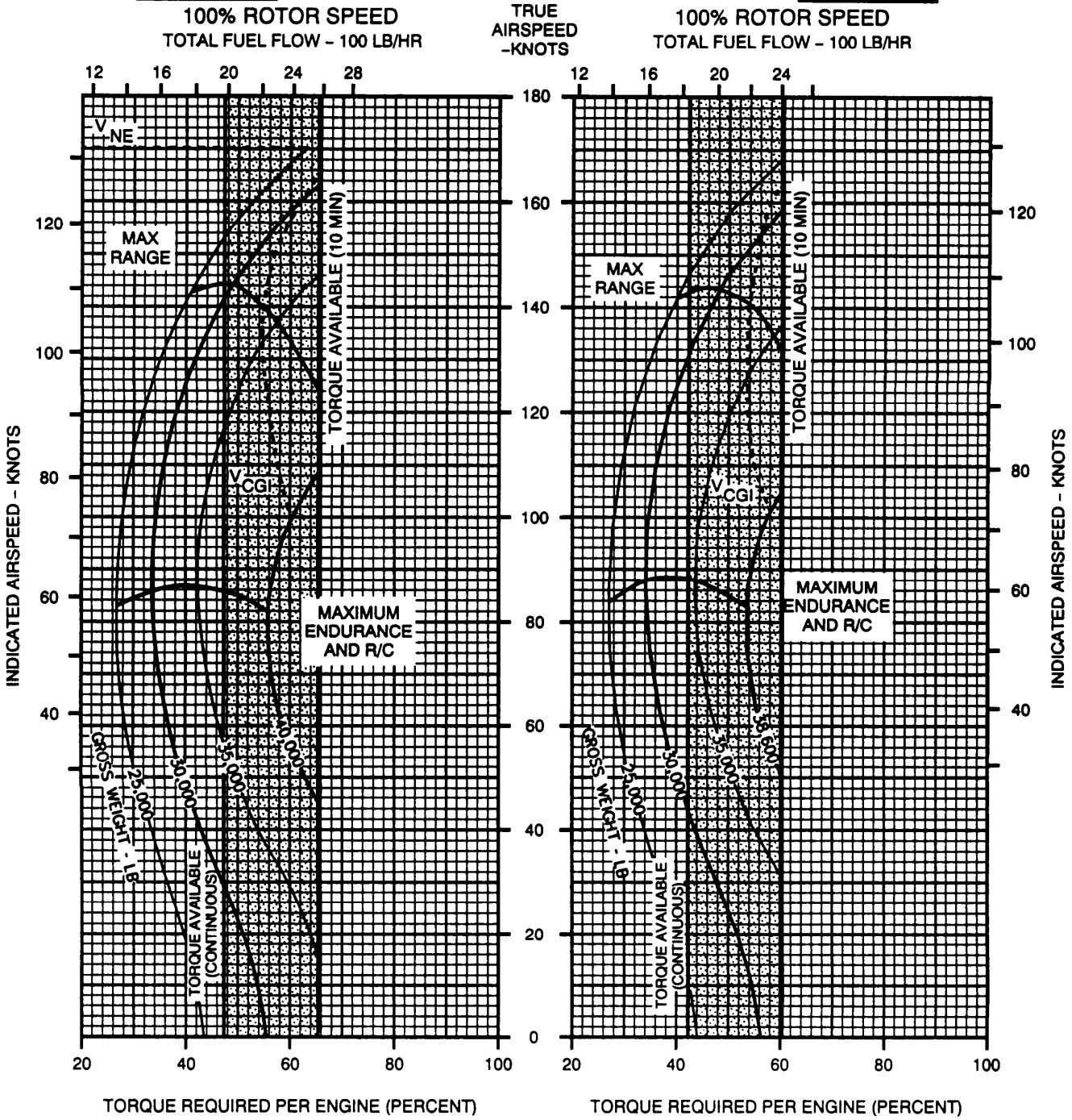
**PRESSURE ALTITUDE - 14,000 FT**

**CRUISE  
CH-47D  
(2) T55-L-712**

**CLEAN CONFIGURATION JP-4 FUEL**

**FAT=10°C**

**FAT=20°C**



DATA BASIS: FLIGHT TEST

A19323

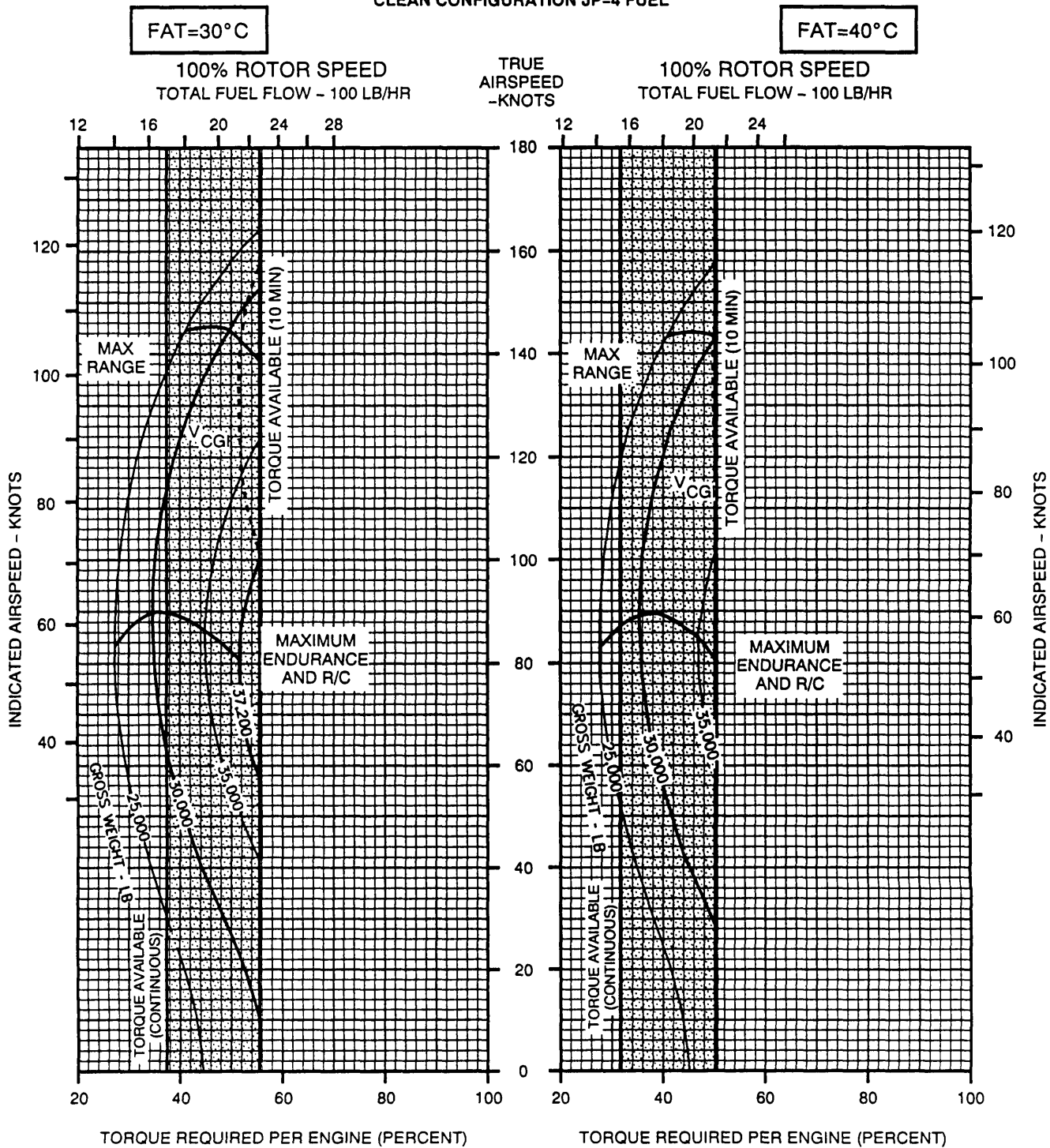
Figure 7-71. 100% Rotor RPM, 10° and 20°C, 14,000 Feet

**CRUISE**

**PRESSURE ALTITUDE - 14,000 FT**

**CRUISE  
CH-47D  
(2) T55-L-712**

**CLEAN CONFIGURATION JP-4 FUEL**



DATA BASIS: FLIGHT TEST

A21211

Figure 7-72. 100% Rotor RPM, 30° and 40°C, 14,000 Feet



**CRUISE**

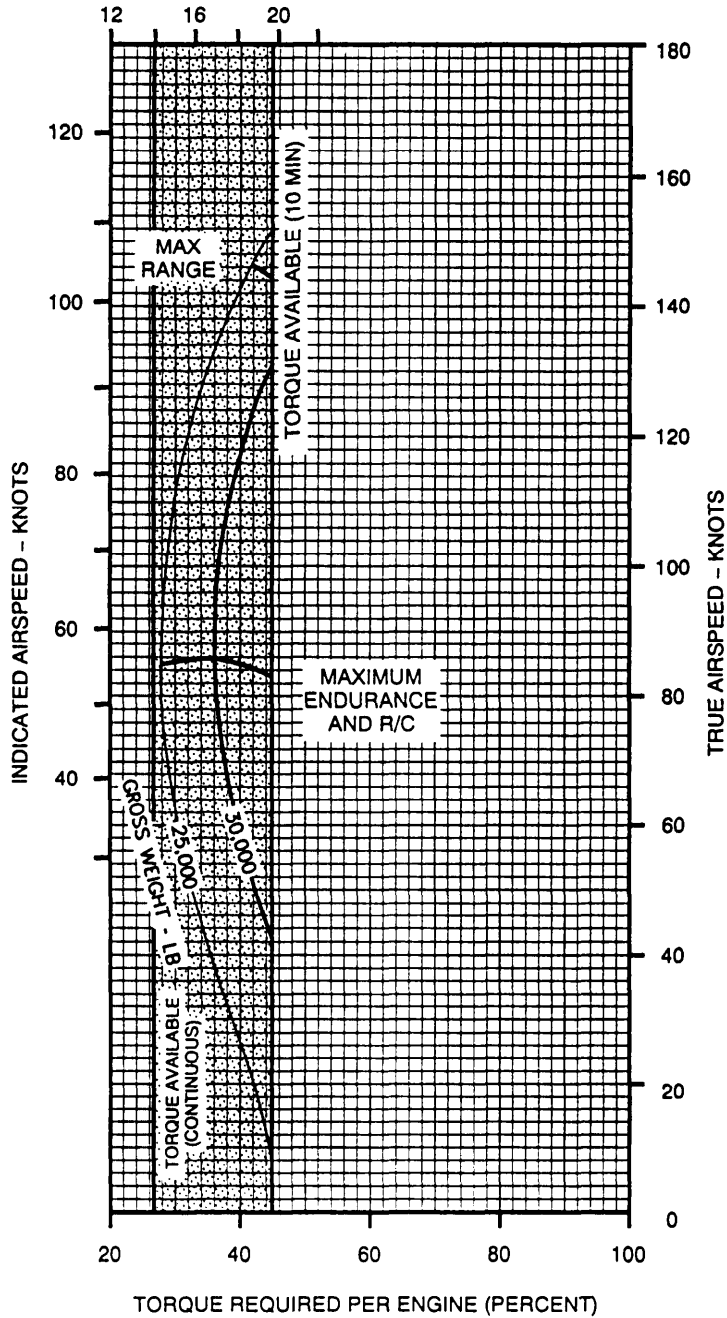
**PRESSURE ALTITUDE - 14,000 FT**

**CRUISE  
CH-47D  
(2) T55-L-712**

**CLEAN CONFIGURATION JP-4 FUEL**

**FAT=50°C**

**100% ROTOR SPEED  
TOTAL FUEL FLOW - 100 LB/HR**



**DATA BASIS: FLIGHT TEST**

**A9416**

**Figure 7-73. 100% Rotor RPH, 50°C, 14,000 Feet**

**CRUISE**

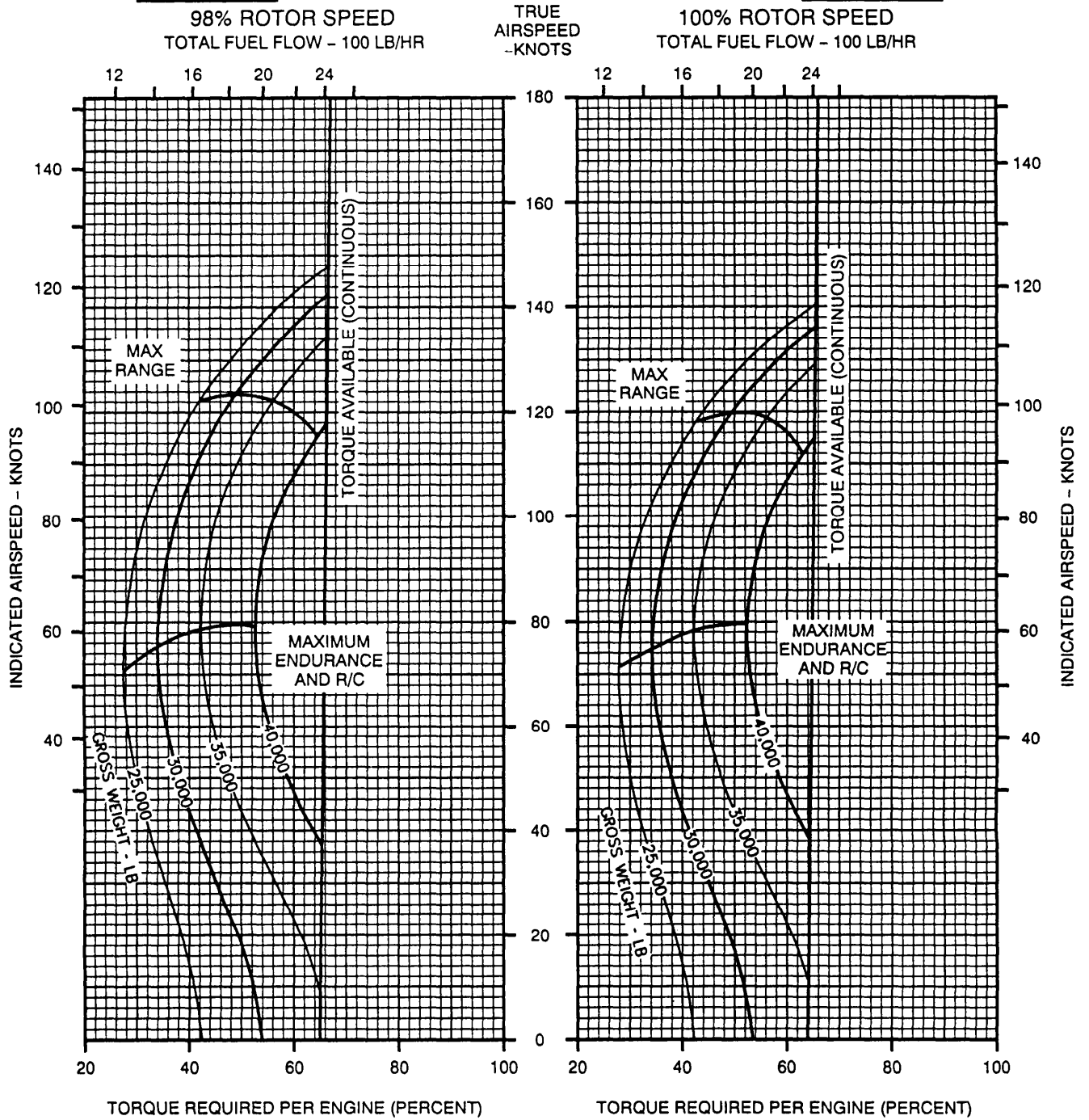
**PRESSURE ALTITUDE - 16,000 FT**

**CRUISE  
CH-47D  
(2) T55-L-712**

**CLEAN CONFIGURATION JP-4 FUEL**

**FAT=-50 °C**

**FAT=-50 °C**



DATA BASIS: FLIGHT TEST

A9417

Figure 7-74. 98 and 100% Rotor RPM, -50°C, 16,000 Feet

**CRUISE**

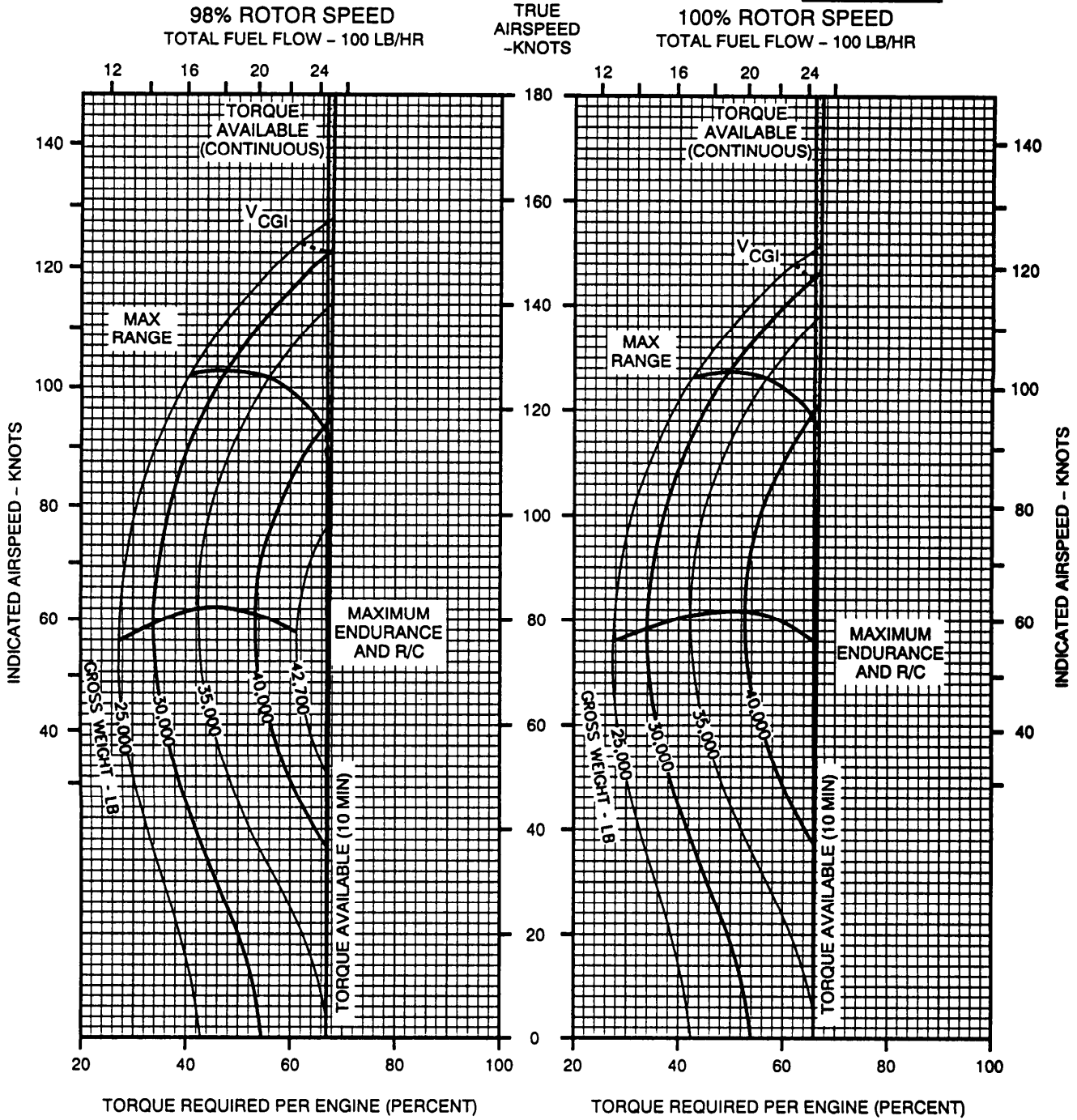
**PRESSURE ALTITUDE - 16,000 FT**

**CRUISE  
CH-47D  
(2) T55-L-712**

**CLEAN CONFIGURATION JP-4 FUEL**

**FAT=-40 °C**

**FAT=-40 °C**



DATA BASIS: FLIGHT TEST

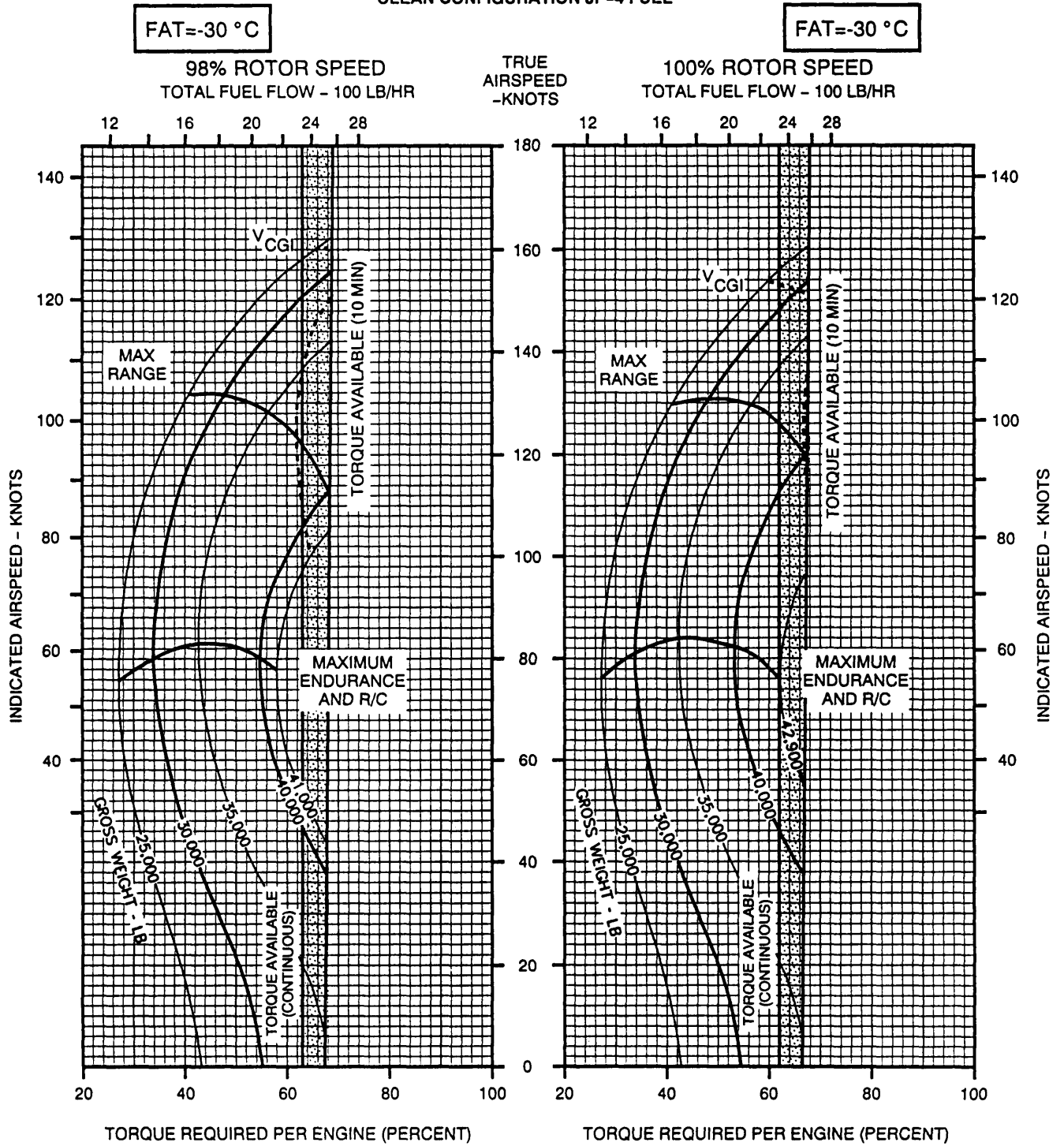
A9418

Figure 7-75. 98 and 100% Rotor RPM, -40°C, 16,000 Feet

**CRUISE**  
**PRESSURE ALTITUDE - 16,000 FT**

**CRUISE**  
**CH-47D**  
**(2) T55-L-712**

CLEAN CONFIGURATION JP-4 FUEL



DATA BASIS: FLIGHT TEST

A9419

Figure 7-76. 98 and 100% Rotor RPM, -30°C, 16,000 Feet

**CRUISE**

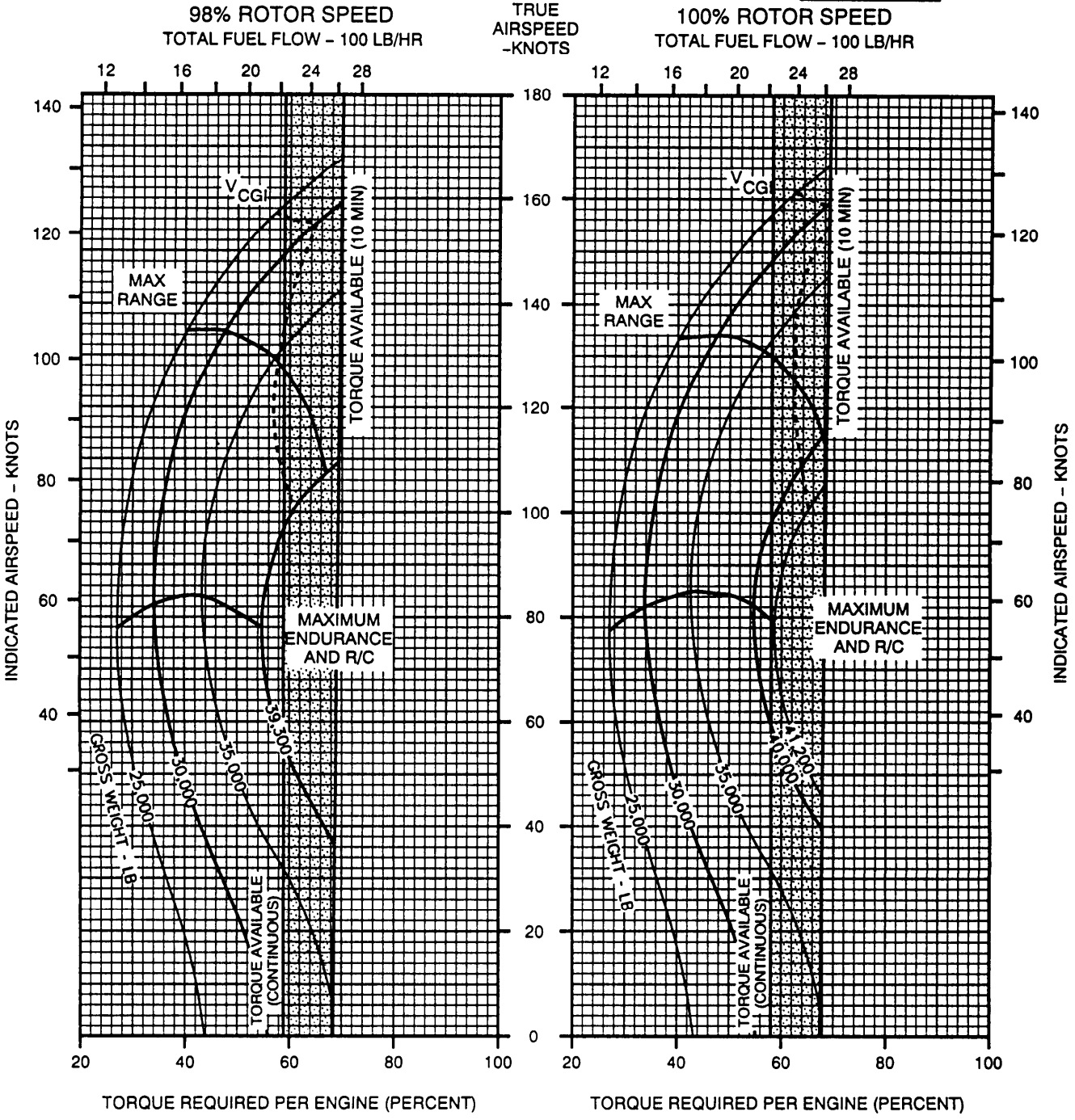
**PRESSURE ALTITUDE - 16,000 FT**

**CRUISE  
CH-47D  
(2) T55-L-712**

**CLEAN CONFIGURATION JP-4 FUEL**

**FAT=-20 °C**

**FAT=-20 °C**



DATA BASIS: FLIGHT TEST

A19324

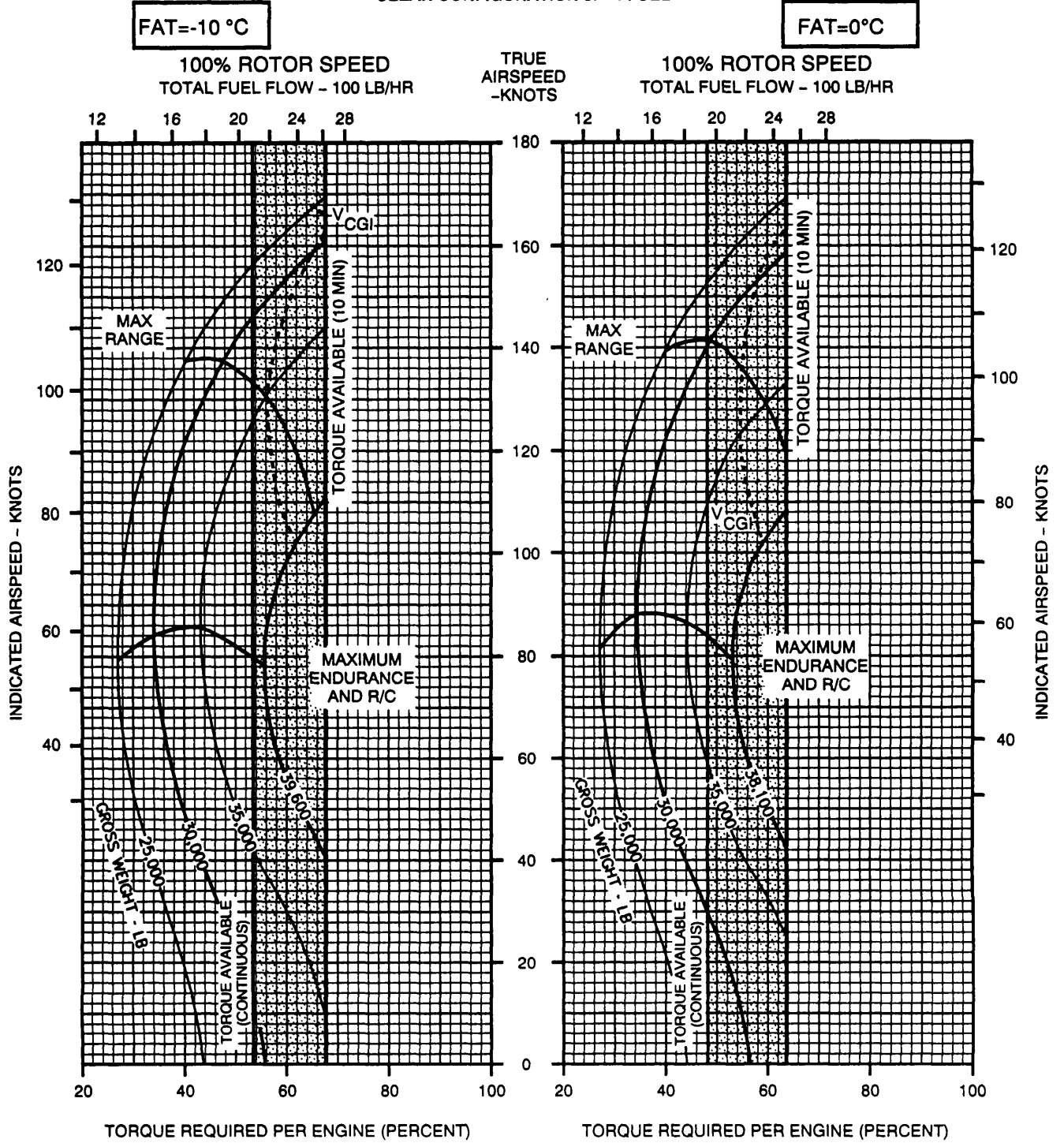
Figure 7-77. 98 and 100% Rotor RPM, -20°C, 16,000 Feet

**CRUISE**

**PRESSURE ALTITUDE - 16,000 FT**

**CRUISE  
CH-47D  
(2) T55-L-712**

**CLEAN CONFIGURATION JP-4 FUEL**



**DATA BASIS:** FLIGHT TEST

A19326

**Figure 7-78. 100% Rotor RPM, -10° and 0°C, 16,000 Feet**

# CRUISE

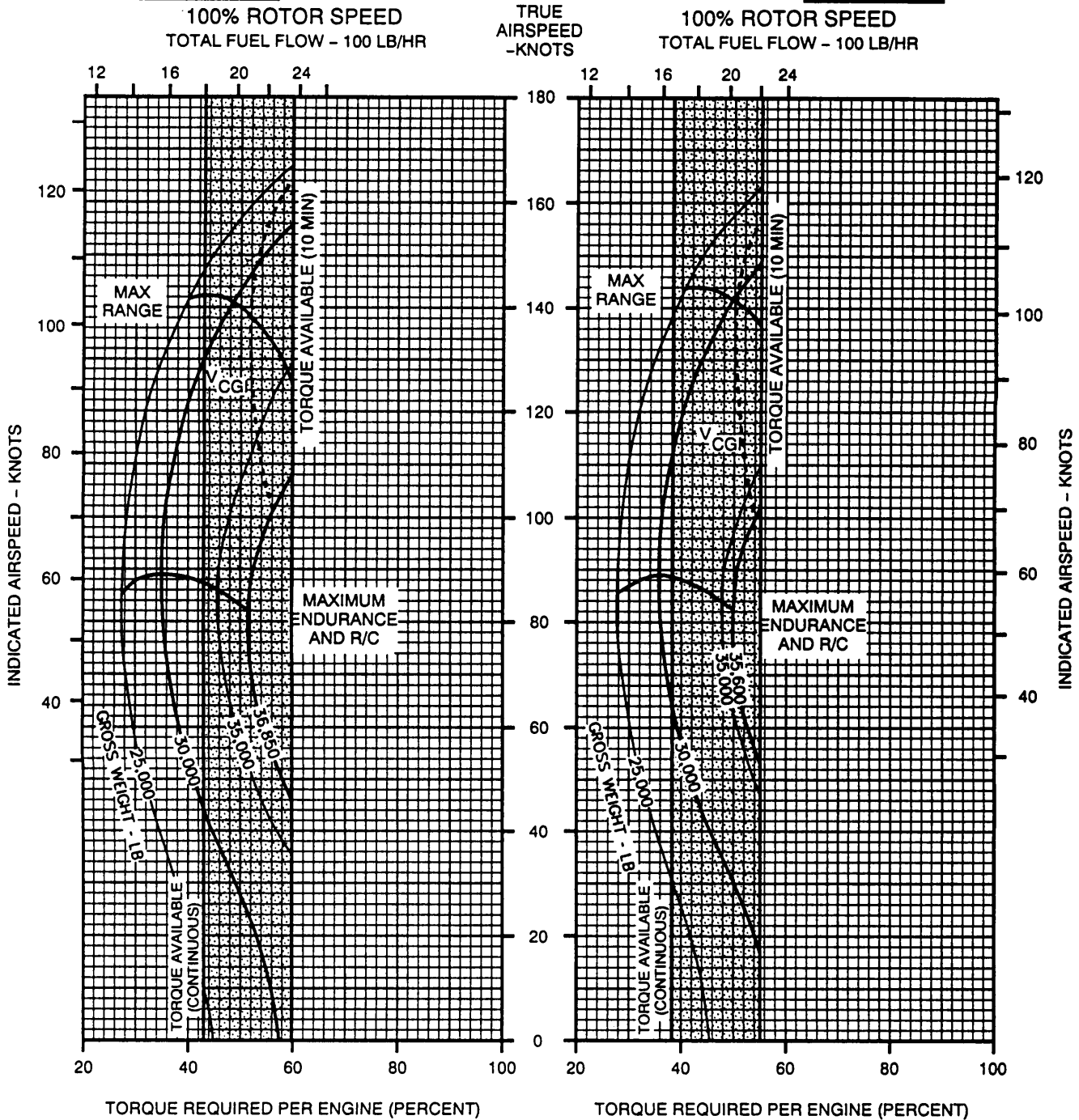
PRESSURE ALTITUDE - 16,000 FT

CRUISE  
CH-47D  
(2) T55-L-712

CLEAN CONFIGURATION JP-4 FUEL

FAT=10°C

FAT=20°C



DATA BASIS: FLIGHT TEST

A19327

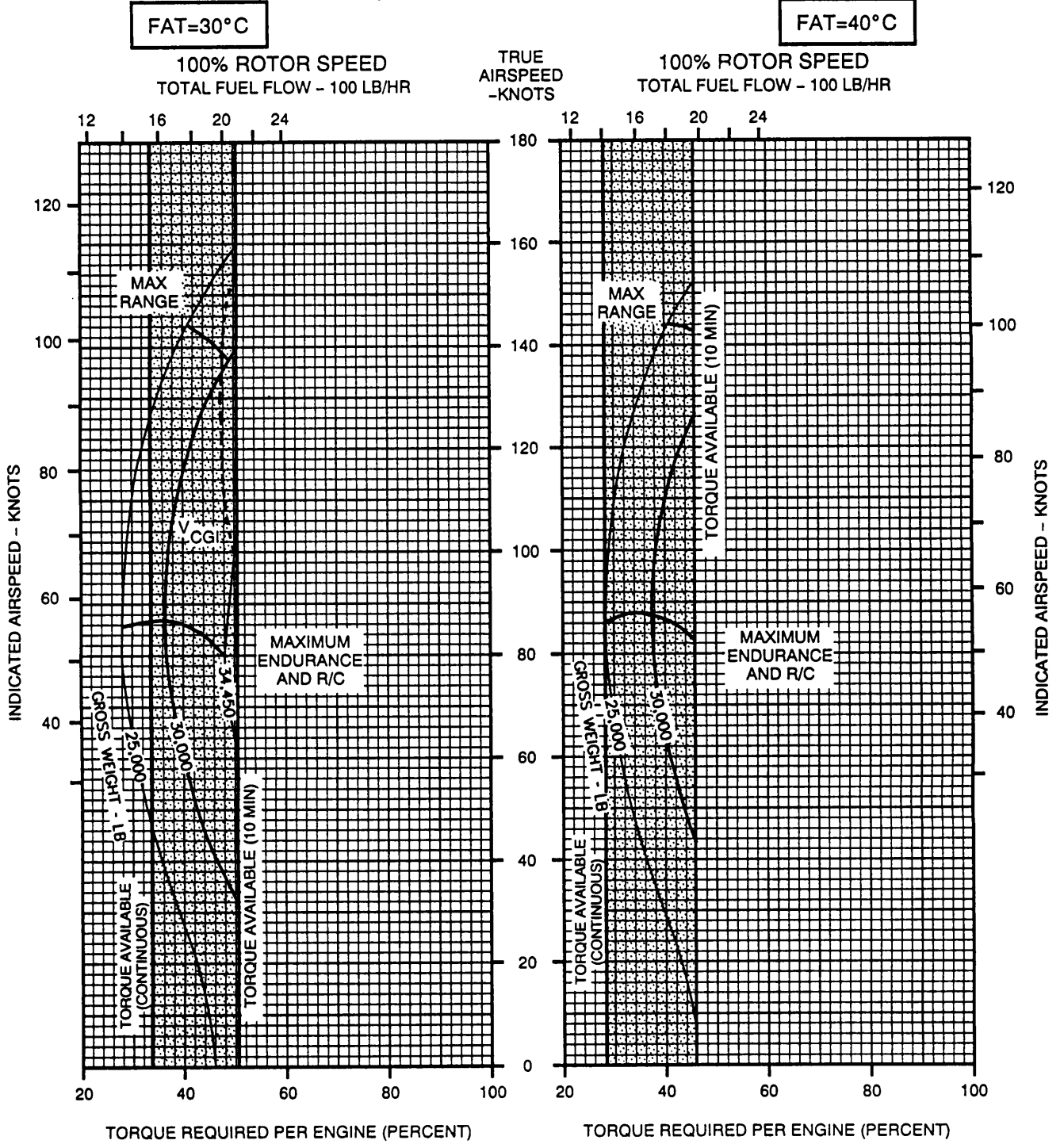
Figure 7-79. 100% Rotor RPM, 10° and 20°C, 16,000 Feet

**CRUISE**

**PRESSURE ALTITUDE - 16,000 FT**

**CRUISE  
CH-47D  
(2) T55-L-712**

**CLEAN CONFIGURATION JP-4 FUEL**



DATA BASIS: FLIGHT TEST

A21212

Figure 7-80. 100% Rotor RPM, 30° and 40°C, 16,000 Feet



**CRUISE**

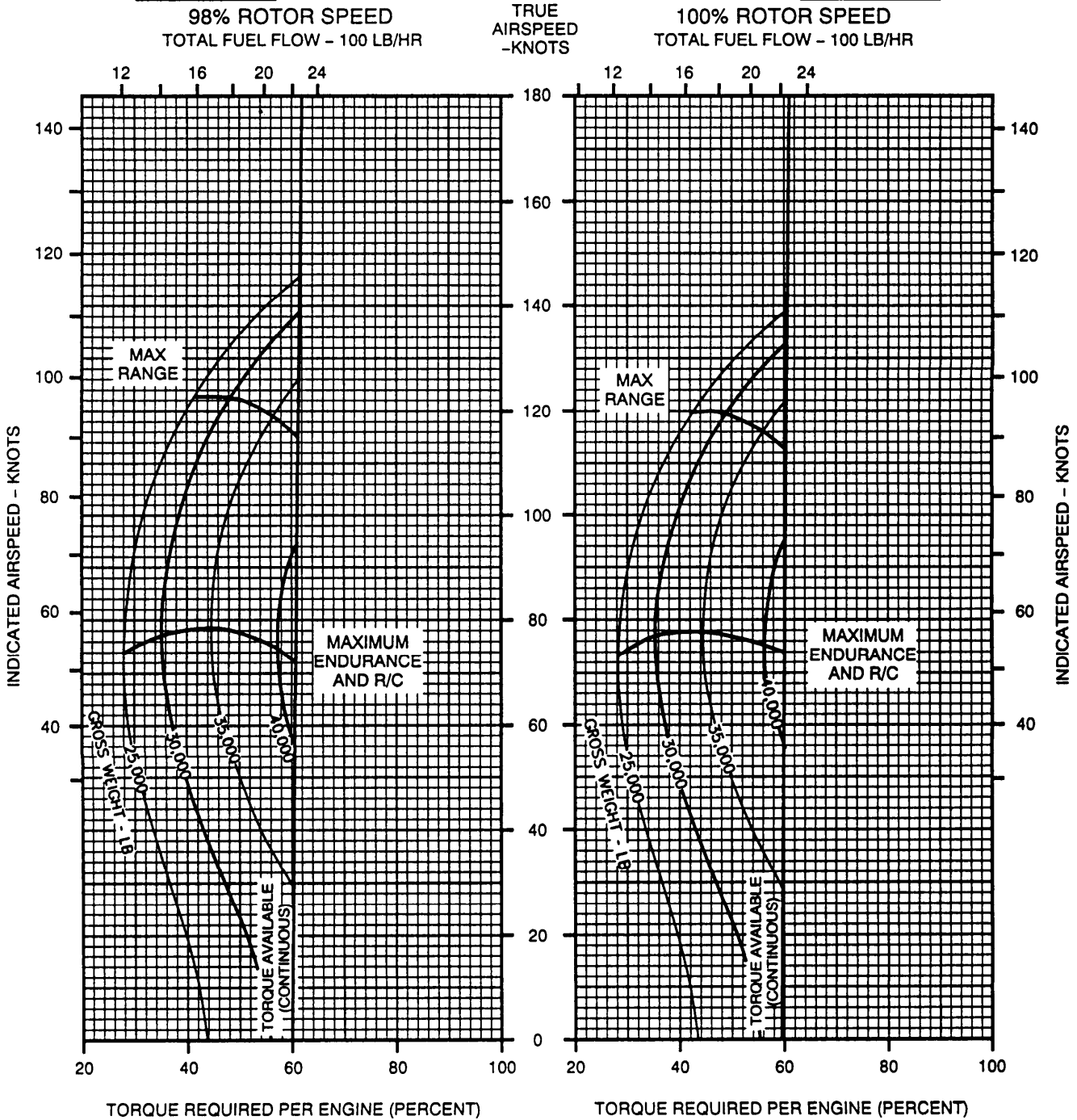
**PRESSURE ALTITUDE - 18,000 FT**

**CRUISE  
CH-47D  
(2) T55-L-712**

**CLEAN CONFIGURATION JP-4 FUEL**

**FAT=-50 °C**

**FAT=-50 °C**



DATA BASIS: FLIGHT TEST

A9421

Figure 7-81. 98 and 100% Rotor RPM, -50°C, 18,000 Feet

**CRUISE**

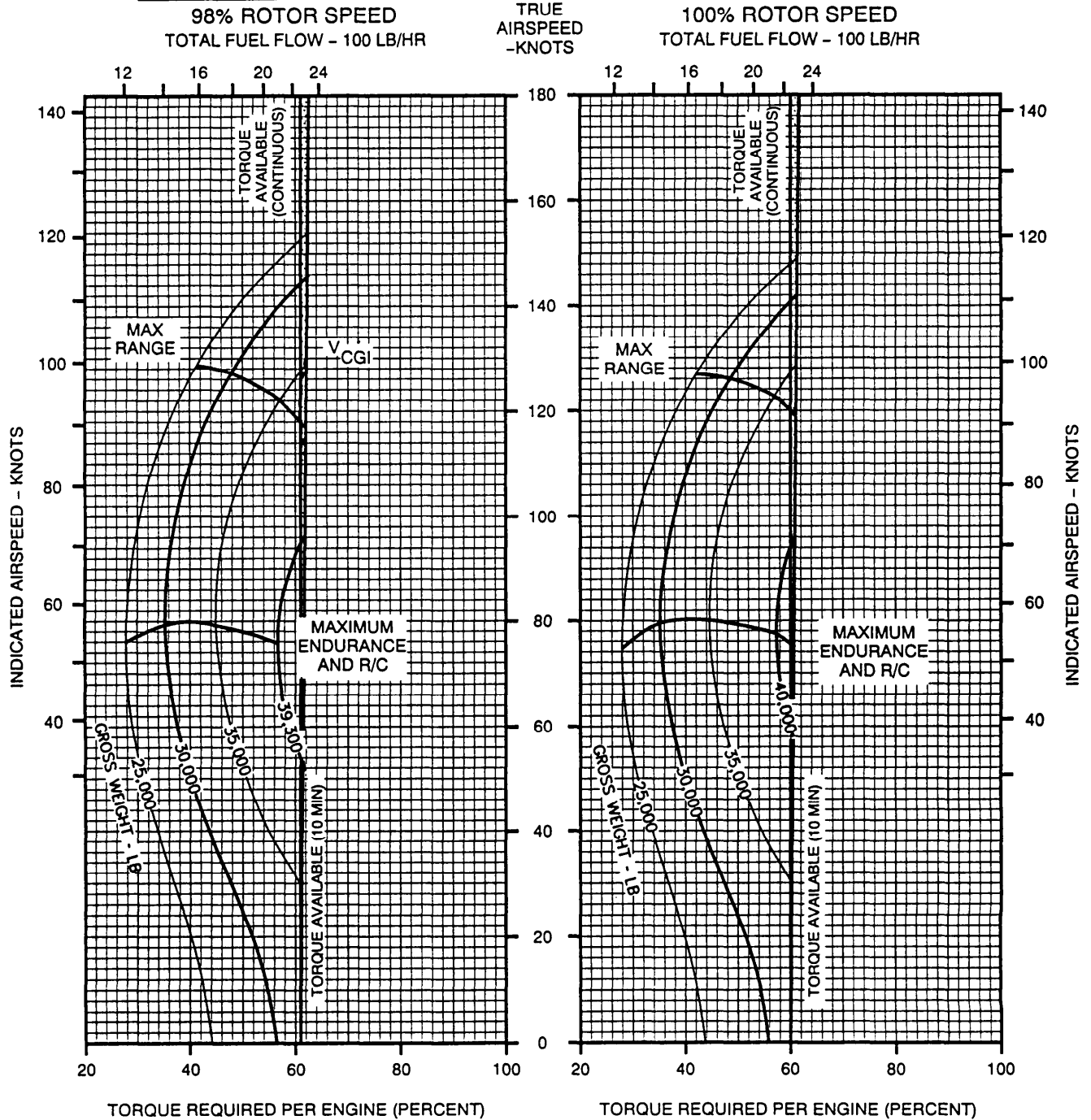
**PRESSURE ALTITUDE - 18,000 FT**

**CRUISE  
CH-47D  
(2) T55-L-712**

**CLEAN CONFIGURATION JP-4 FUEL**

**FAT=-40 °C**

**FAT=-40 °C**



DATA BASIS: FLIGHT TEST

A9422

Figure 7-82. 98 and 100% Rotor RPM, -40°C, 18,000 Feet

# CRUISE

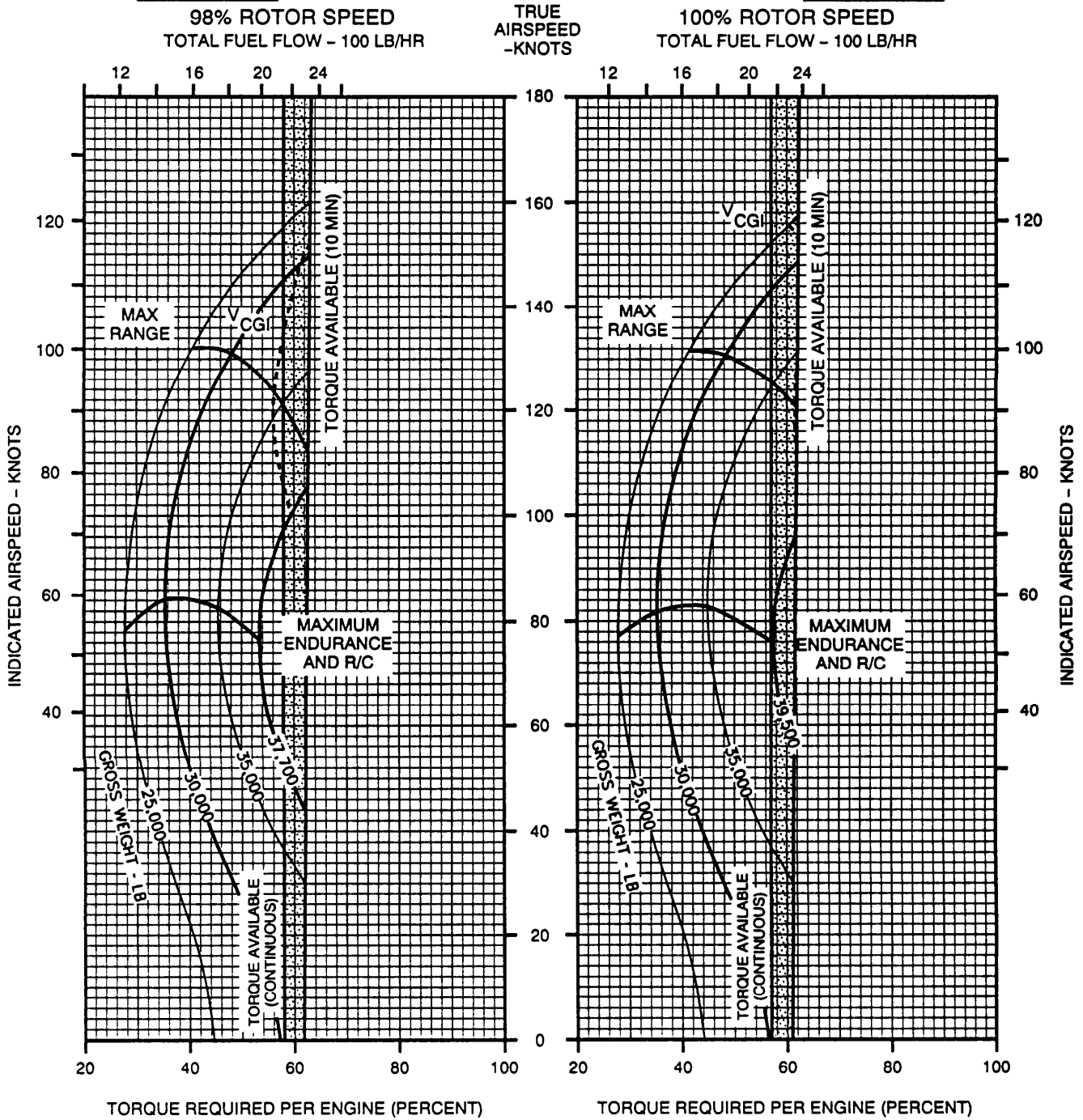
PRESSURE ALTITUDE - 18,000 FT

CRUISE  
CH-47D  
(2) T55-L-712

CLEAN CONFIGURATION JP-4 FUEL

FAT=-30 °C

FAT=-30 °C



DATA BASIS: FLIGHT TEST

A9423

Figure 7-83. 98 and 100% Rotor RPM, -30°C, 18,000 Feet

# CRUISE

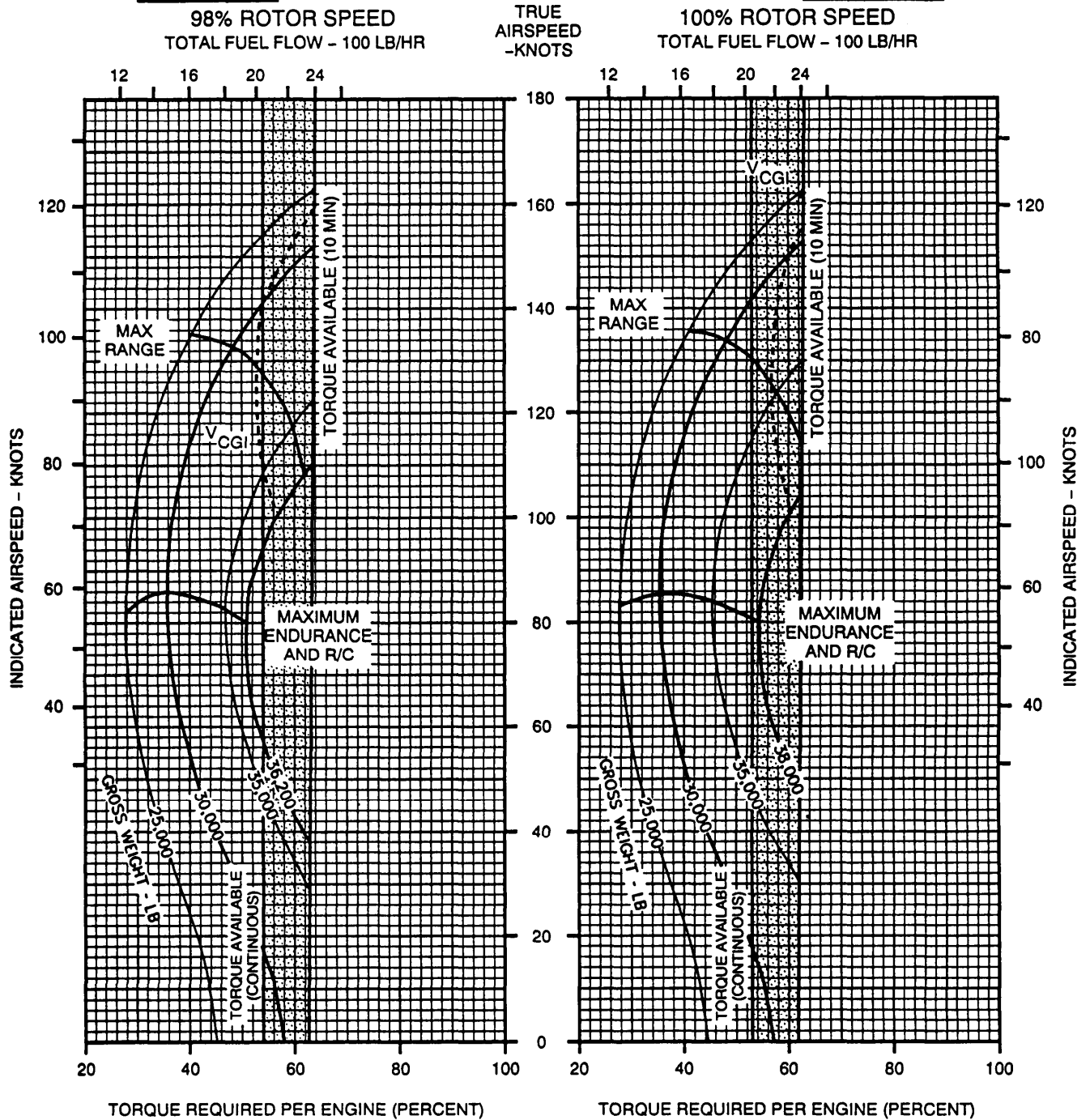
PRESSURE ALTITUDE - 18,000 FT

CRUISE  
CH-47D  
(2) T55-L-712

CLEAN CONFIGURATION JP-4 FUEL

FAT=-20 °C

FAT=-20 °C



DATA BASIS: FLIGHT TEST

A21213

Figure 7-84. 98 and 100% Rotor RPM, -20°C, 18,000 Feet

CRUISE

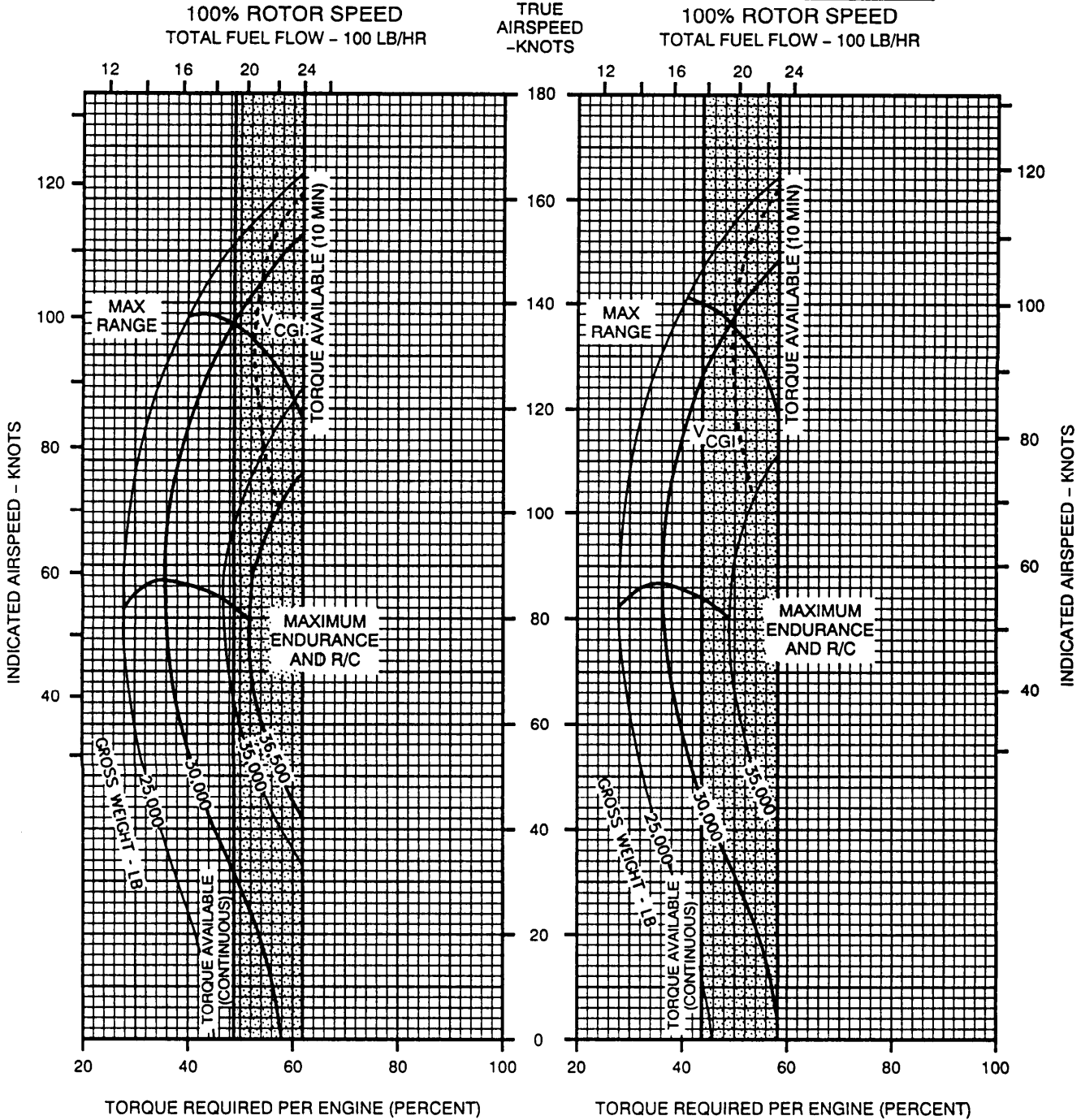
PRESSURE ALTITUDE - 18,000 FT

CRUISE  
CH-47D  
(2) T55-L-712

CLEAN CONFIGURATION JP-4 FUEL

FAT=-10 °C

FAT=0 °C



DATA BASIS: FLIGHT TEST

A19328

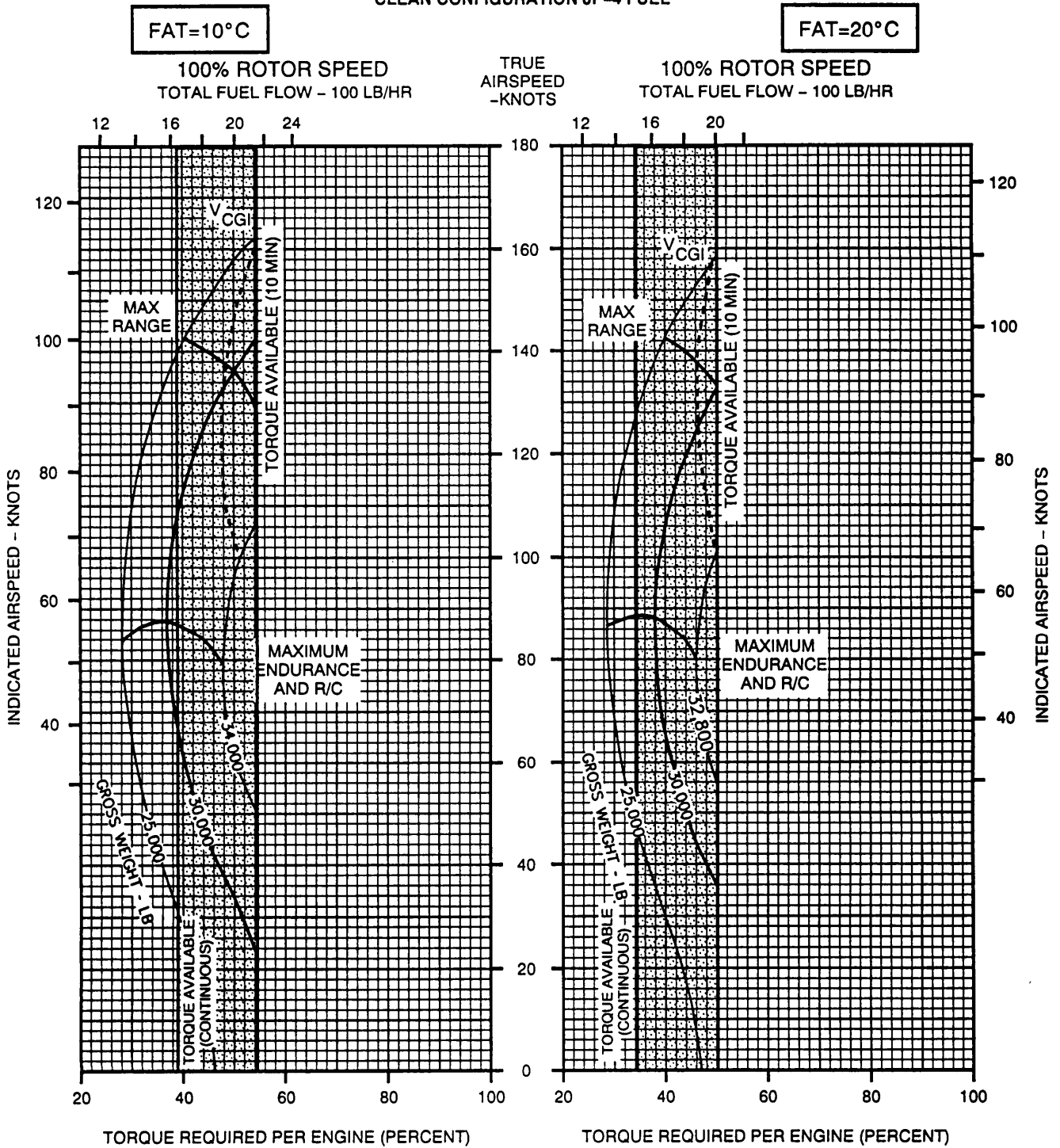
Figure 7-85. 100% Rotor RPM, -10° and 0°C, 18,000 Feet

**CRUISE**

**PRESSURE ALTITUDE - 18,000 FT**

**CRUISE  
CH-47D  
(2) T55-L-712**

**CLEAN CONFIGURATION JP-4 FUEL**



DATA BASIS: FLIGHT TEST

A19329

**Figure 7-86. 100% Rotor RPM, 10° and 20°C, 18,000 Feet**

**CRUISE**

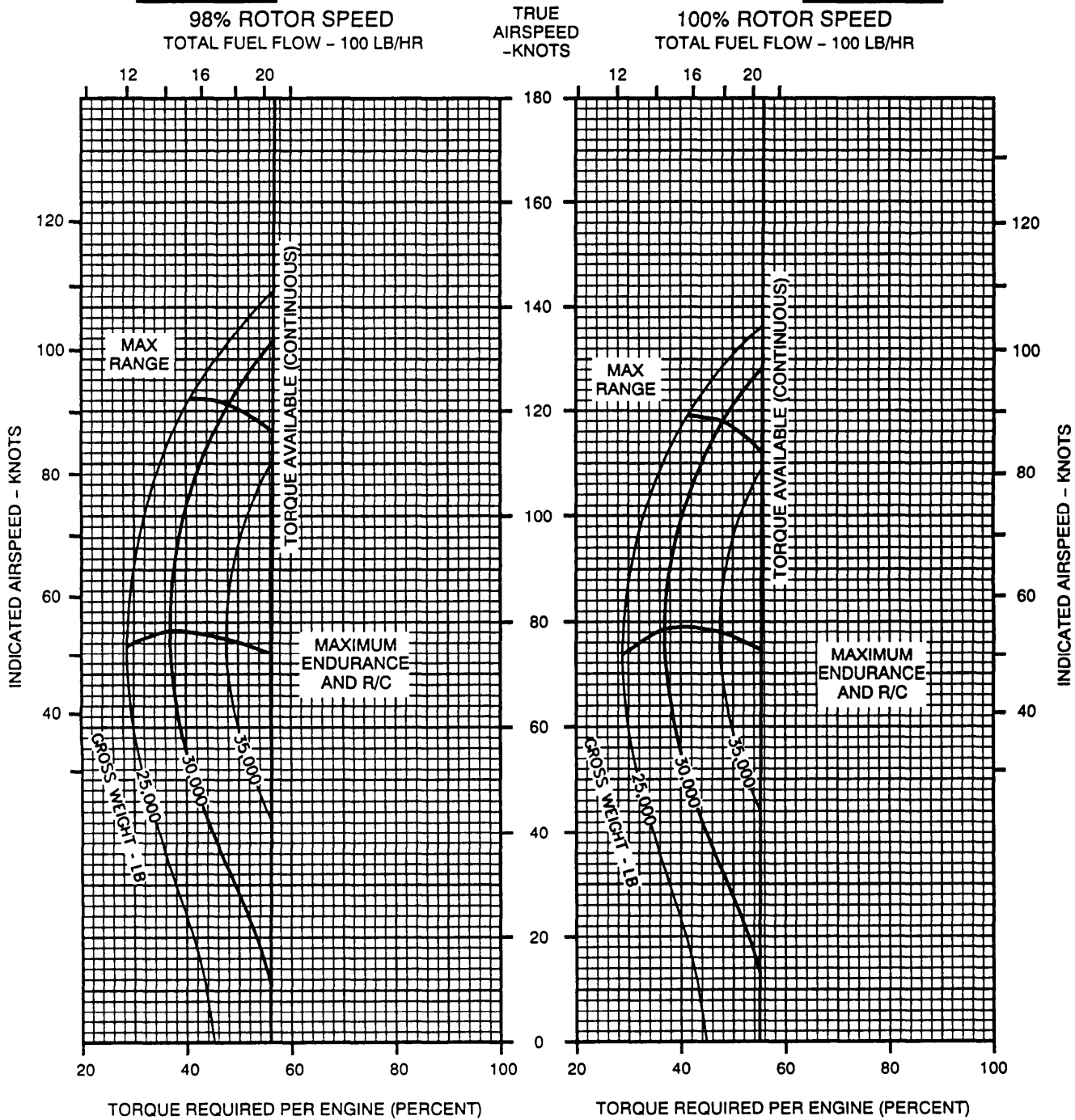
**PRESSURE ALTITUDE - 20,000 FT**

**CRUISE  
CH-47D  
(2) T55-L-712**

**CLEAN CONFIGURATION JP-4 FUEL**

**FAT=-50 °C**

**FAT=-50 °C**



DATA BASIS: FLIGHT TEST

A9424

*Figure 7-87. 98 and 100% Rotor RPM, -50°C, 20,000 Feet*

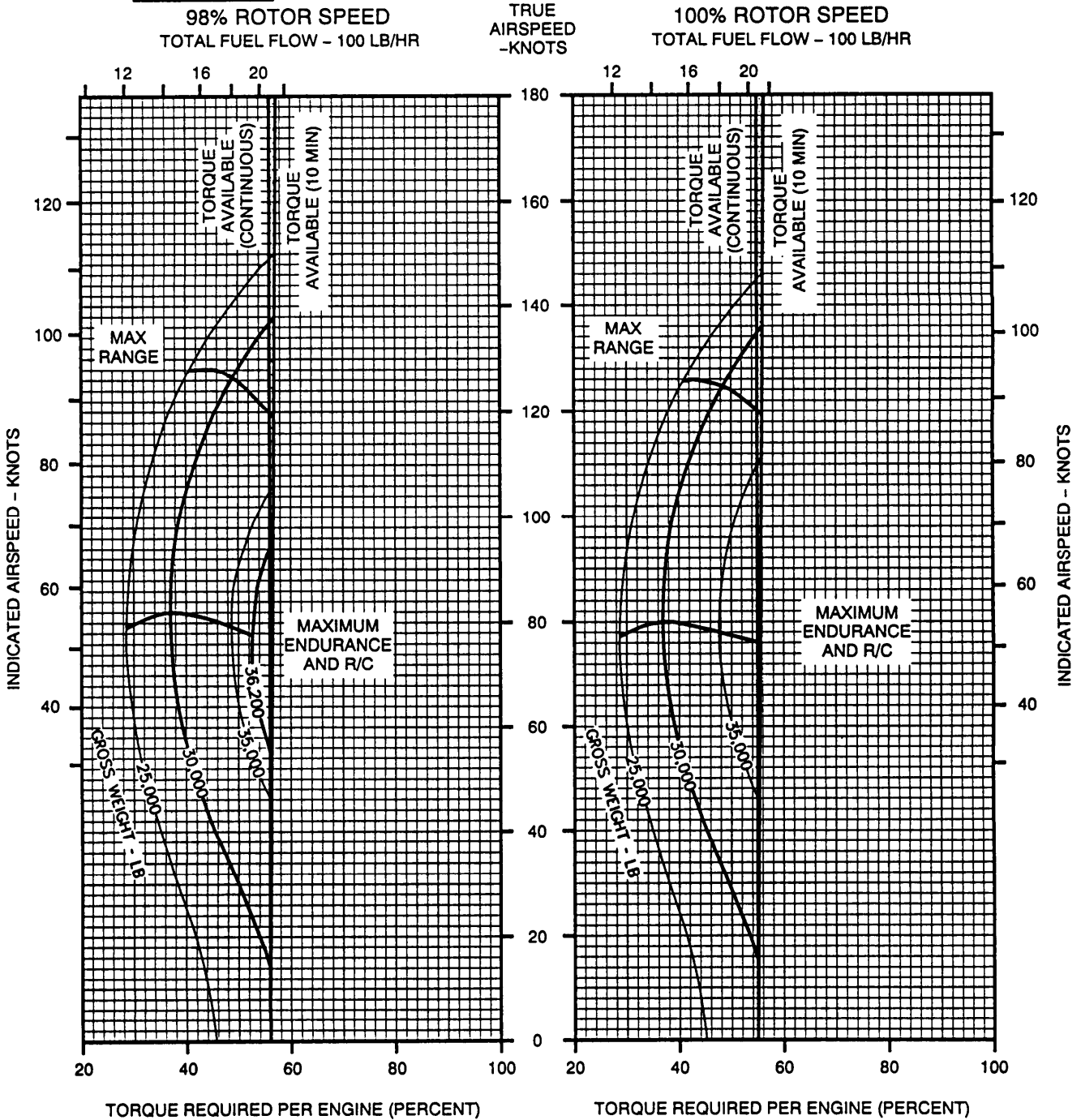
**CRUISE**  
**PRESSURE ALTITUDE - 20,000 FT**

**CRUISE**  
**CH-47D**  
**(2) T55-L-712**

CLEAN CONFIGURATION JP-4 FUEL

**FAT=-40 °C**

**FAT=-40 °C**



DATA BASIS: FLIGHT TEST

A9425

Figure 7-88. 98 and 100% Rotor RPM, -40°C, 20,000 Feet



# CRUISE

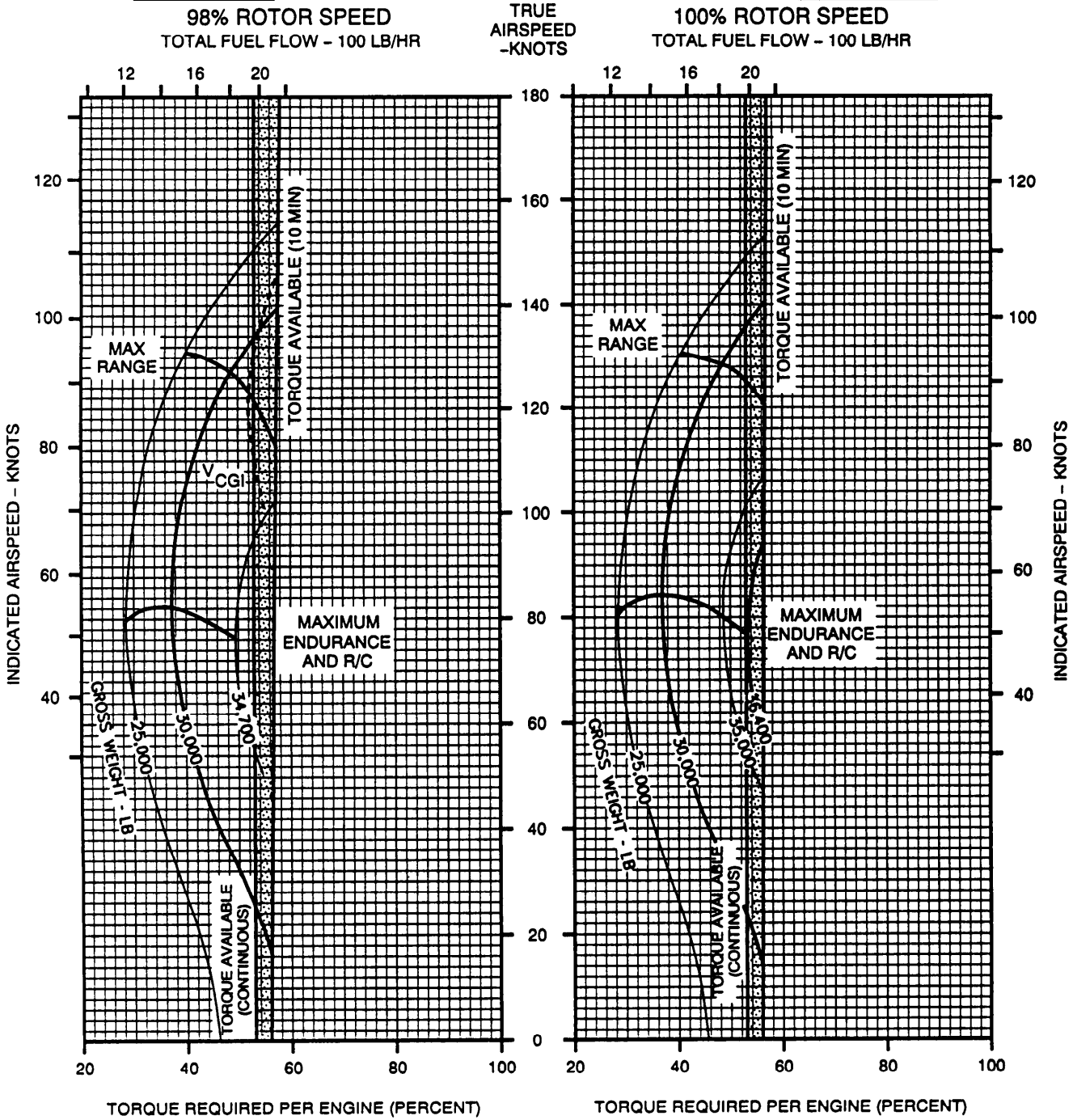
PRESSURE ALTITUDE - 20,000 FT

CRUISE  
CH-47D  
(2) T55-L-712

CLEAN CONFIGURATION JP-4 FUEL

FAT=-30 °C

FAT=-30 °C



DATA BASIS: FLIGHT TEST

A9426

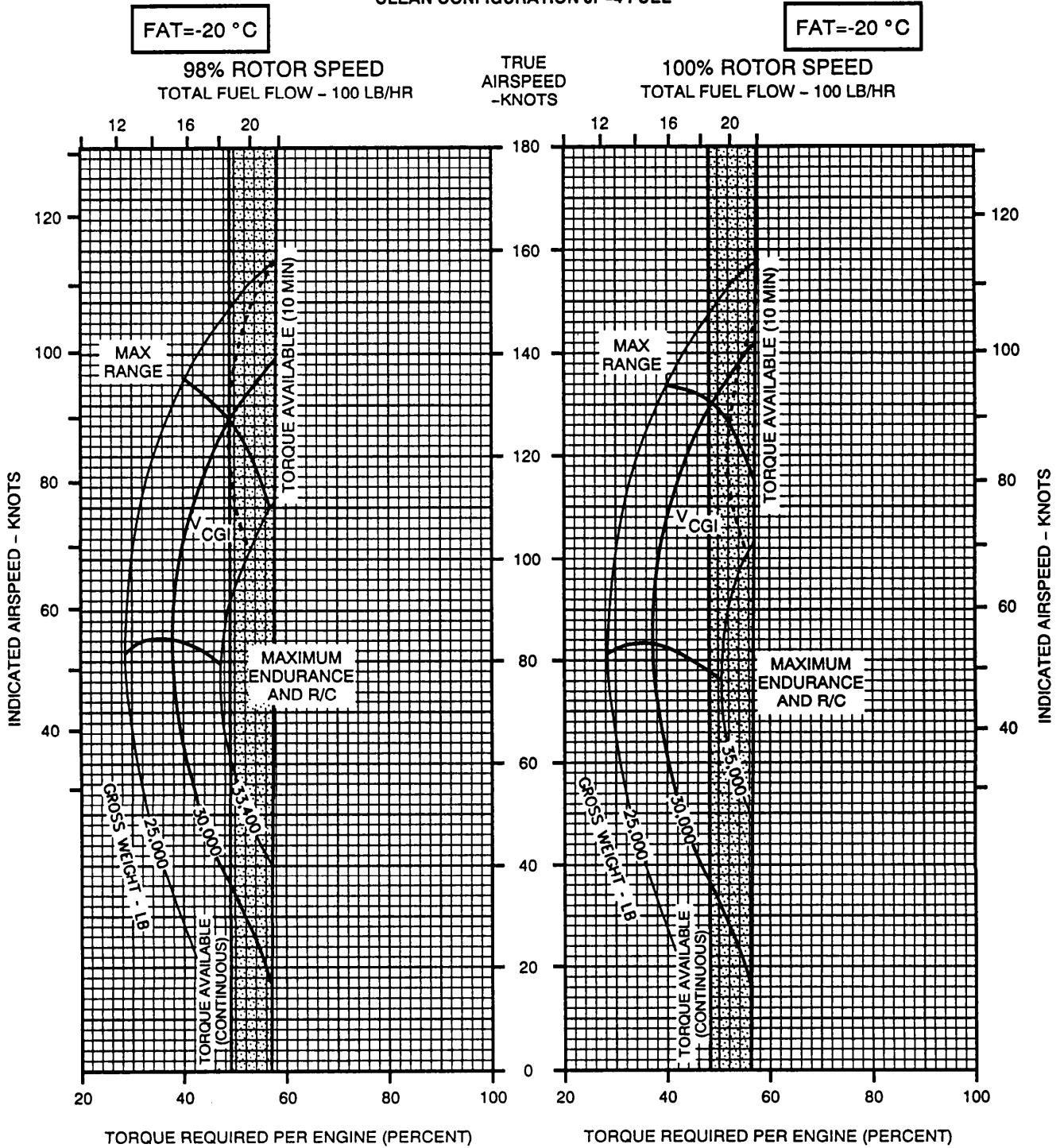
Figure 7-89. 98 and 100% Rotor RPM, -30°C, 20,000 Feet

**CRUISE**

**PRESSURE ALTITUDE - 20,000 FT**

**CRUISE  
CH-47D  
(2) T55-L-712**

**CLEAN CONFIGURATION JP-4 FUEL**



DATA BASIS: FLIGHT TEST

A21257

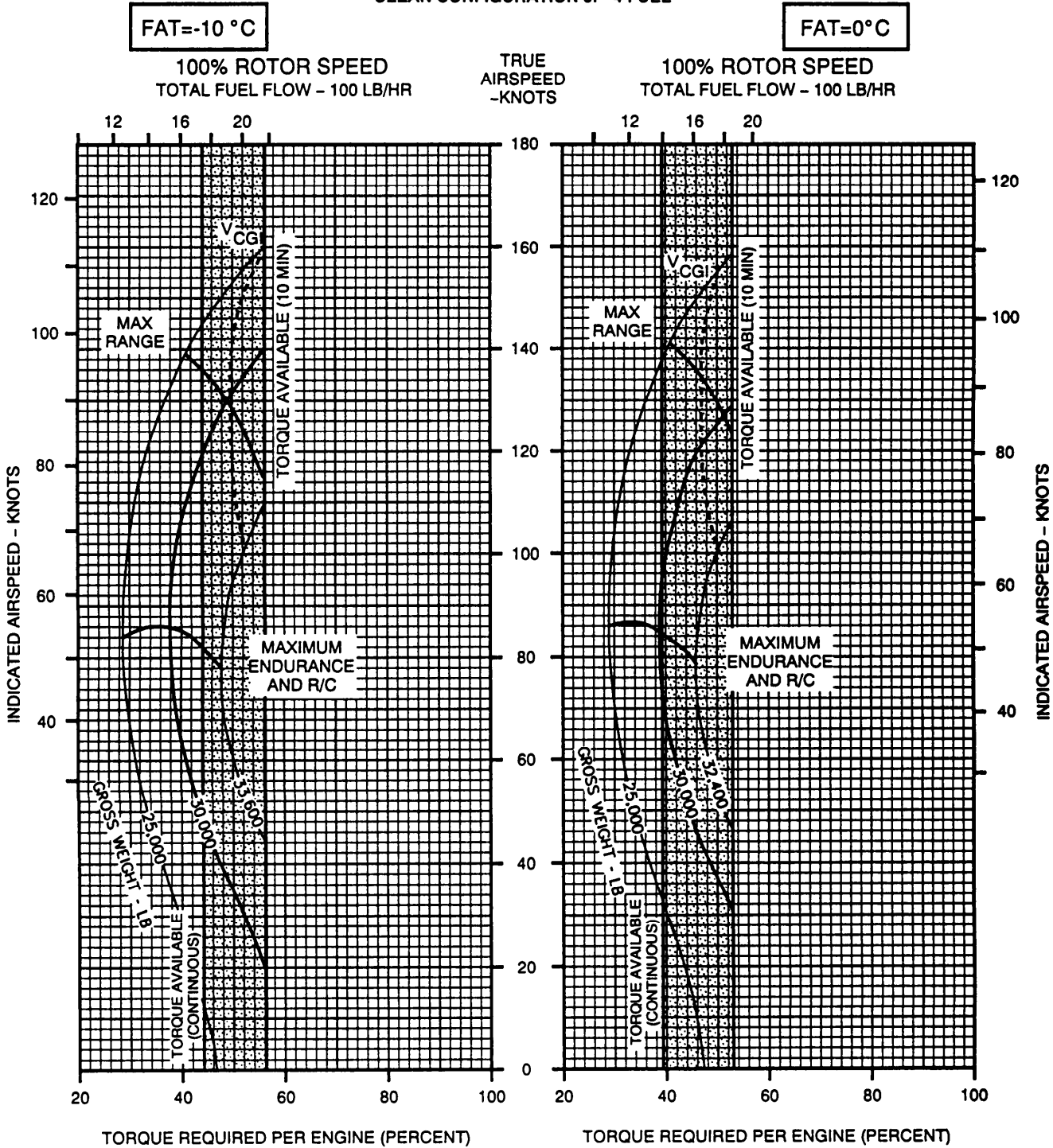
Figure 7-90. 98 and 100% Rotor RPM, -20°C, 20,000 Feet

**CRUISE**

**PRESSURE ALTITUDE - 20,000 FT**

**CRUISE  
CH-47D  
(2) T55-L-712**

**CLEAN CONFIGURATION JP-4 FUEL**



DATA BASIS: FLIGHT TEST

A21258

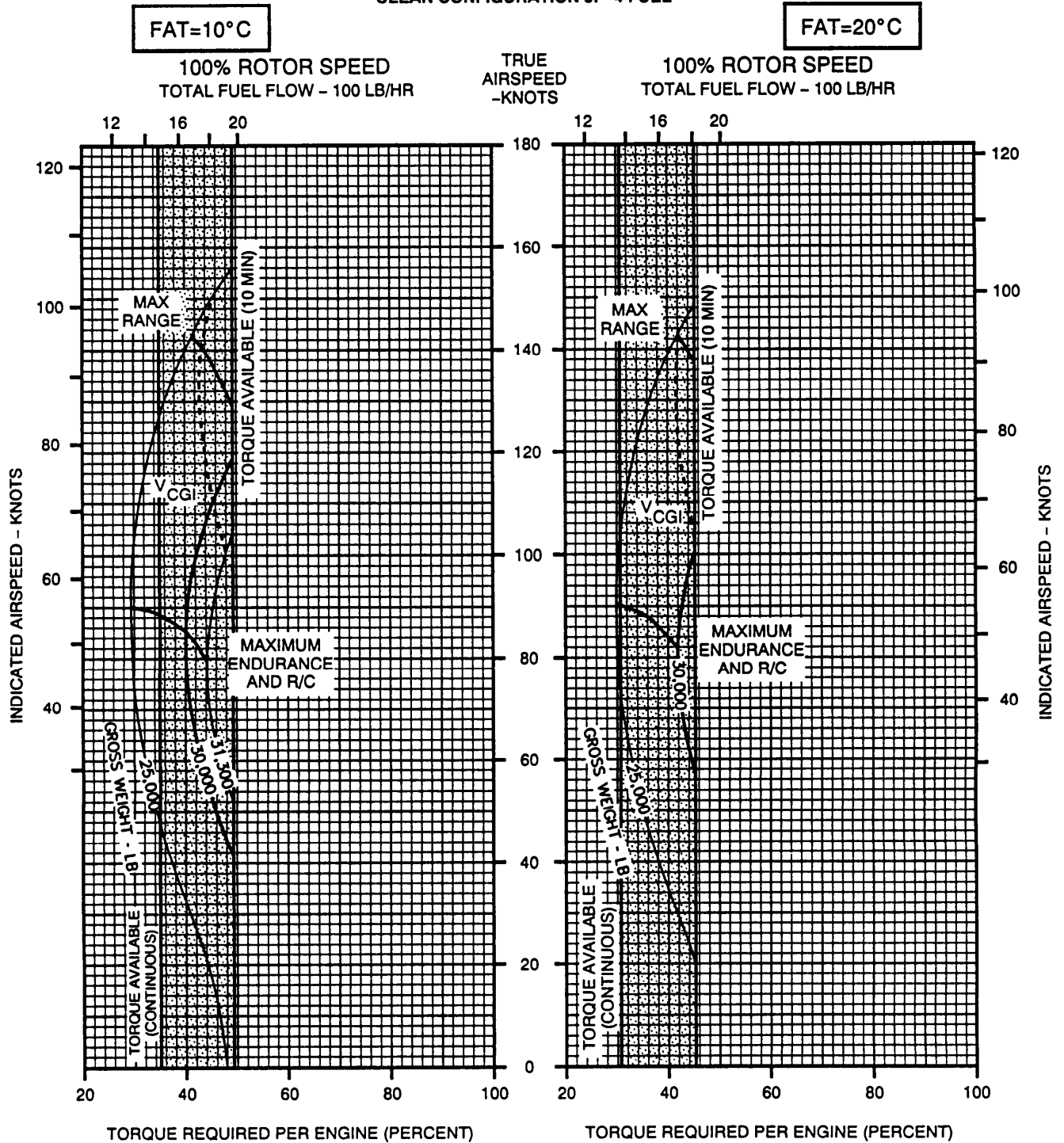
Figure 7-91. 100% Rotor RPM, -10° and 0°C, 20,000 Feet

**CRUISE**

**PRESSURE ALTITUDE - 20,000 FT**

**CRUISE  
CH-47D  
(2) T55-L-712**

**CLEAN CONFIGURATION JP-4 FUEL**



DATA BASIS: FLIGHT TEST

A21182

Figure 7-92. 100% Rotor RPM, 10° and 20°C, 20,000 Feet

## SECTION VIII DRAG

### 7-31. Description.

The drag chart (fig. 7-93) shows the torque change required for flight due to drag area change as a result of external configuration changes.

### 7-32. Use of Charts.

The primary use of the chart is illustrated by the example. To determine the change in torque, it is necessary to know the drag area change, TAS, PA, and FAT. From the table below find the drag area change associated with the configuration, or estimate if necessary. Enter chart at known drag area change, move right to TAS, move down to PA, move left to FAT, then move down and read change in engine torque.

### 7-33. Conditions.

The drag chart is based on operating at 100% RRPM.

**Table 7-1. Change in Drag Area of Typical External Loads**

LOAD	DRAG AREA CHANGE SQ FT
8 FT X 8 FT X 20 FT CONEX CONTAINER	150/100(1)
(2) 500 GAL FUEL, CELLS	40
(3) 500 GAL FUEL CELLS	60
(4) 500 GAL FUEL CELLS	80
M35-2½ TON CARGO TRUCK	80
M37-¾ TON CARGO TRUCK	60
HMMWV (ENCLOSED VEHICLE)	49/28(1)
HMMWV (TOW LAUNCHER)	54/31(1)
M2A1-105MM HOWITZER	50
M102-105MM HOWITZER	50
M198-155MM HOWITZER GUN	149/50(1)
OH-6 HELICOPTER	40(2)
CH-47 HELICOPTER	230(2)
OV-10 FIXED WING AIRCRAFT	80(2)
<hr/>	
(1) WITH DUAL POINT SUSPENSION	
(2) RIGGED IN ACCORDANCE WITH FM1-513, JAN 1990	DATA BASIS: ESTIMATED/ FLIGHT TEST

# DRAG 100% ROTOR RPM

DRAG  
CH-47D  
T55-L-712

**EXAMPLE**

**WANTED**

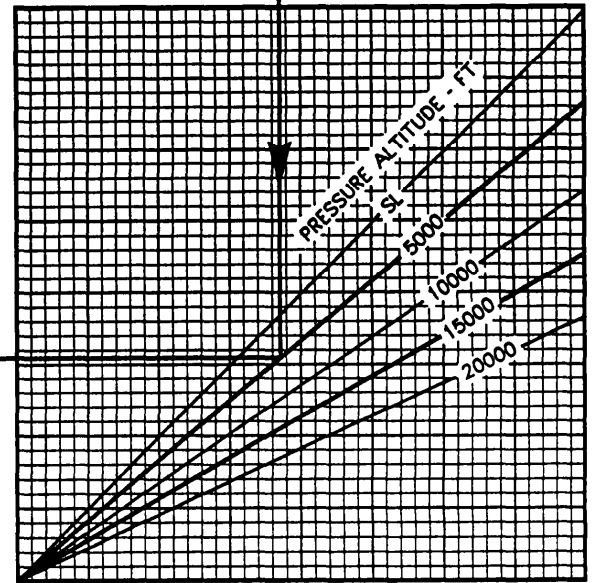
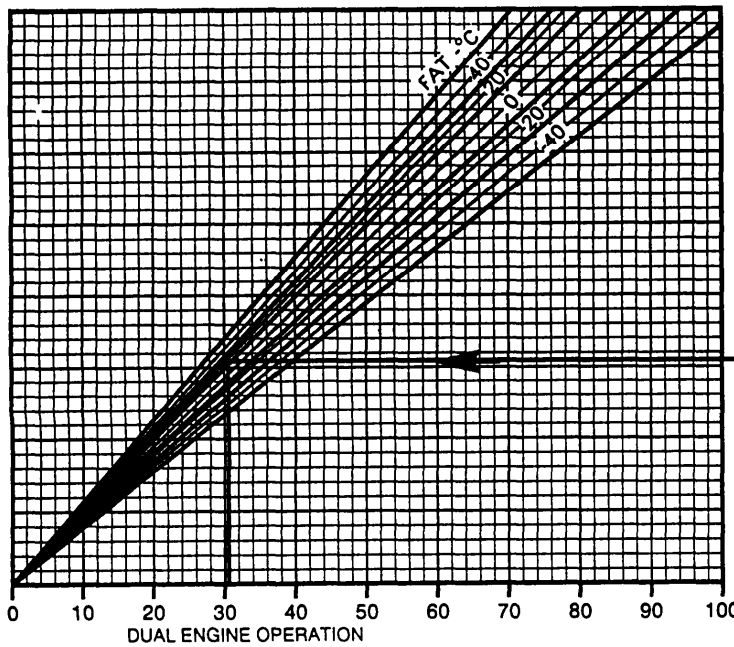
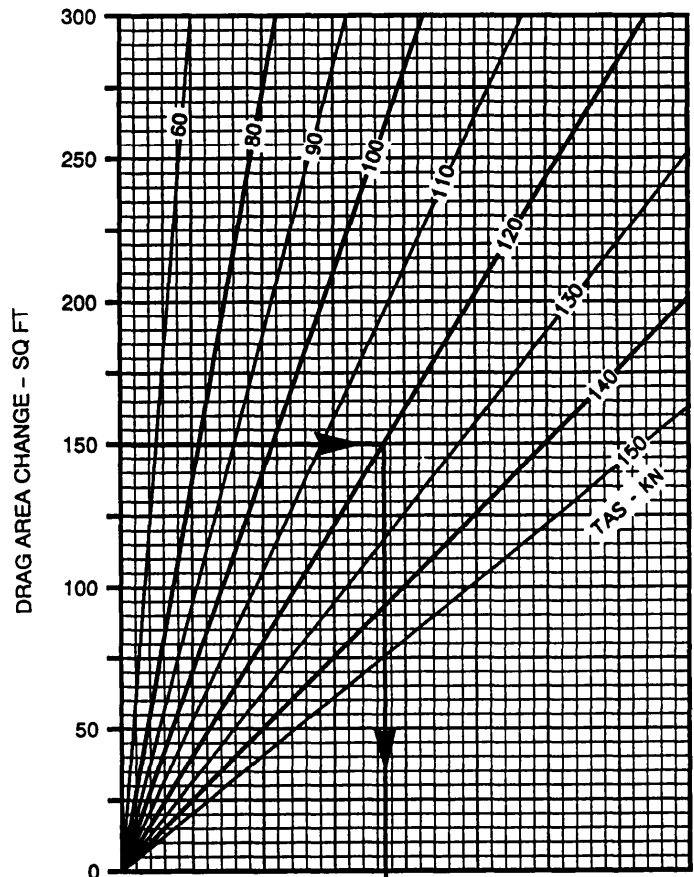
ADDITIONAL TORQUE REQUIRED FOR CRUISE  
WITH AN EXTERNAL LOAD

**KNOWN**

EXTERNAL LOAD = 8 X 8 X 20 FT CONEX CONTAINER  
TRUE AIRSPEED = 120 KN  
PRESSURE ALTITUDE = 5,000 FT  
FAT = 20°C

**METHOD**

FROM THE TABLE OPPOSITE DETERMINE THE EQUIVALENT  
DRAG AREA OF THE LOAD = 150 SQ FT  
ENTER THIS VALUE OF DRAG AREA HERE  
MOVE RIGHT TO DESIRED TRUE AIRSPEED = 120 KN  
MOVE DOWN TO PRESSURE ALTITUDE = 5,000 FT  
MOVE LEFT TO FAT = 20°C  
MOVE DOWN, READ ADDITIONAL TORQUE REQUIRED  
PER ENGINE = 31 PERCENT, DUAL ENGINE, AND  
62 PERCENT SINGLE ENGINE OPERATION



0 10 20 30 40 50 60 70 80 90 100  
DUAL ENGINE OPERATION  
0 20 40 60 80 100 120 140  
SINGLE ENGINE OPERATION  
CHANGE IN TORQUE REQUIRED PER ENGINE - PERCENT

DATA BASIS: CALCULATED

A8013

Figure 7-93. Drag Chart

## SECTION IX CLIMB-DESCENT

### 7-34. Description.

a. Climb and descent performance may be seen in figure 7-94, which presents change in torque to climb or descend at selected GWs.

b. The climb performance charts, figure 7-95, shows relationships between GW, initial and final altitude and temperatures, time to climb, and distance covered and fuel used while climbing. The chart is presented for climbing at hotter and colder temperatures, intermediate torque (30 minute operation).

### 7-35. Use of Charts.

The primary use of the charts is illustrated by the chart examples.

a. To determine torque change for a specified rate of climb or rate of descent (fig. 7-94), enter rate of climb or descent and move right to gross weight, move down and read torque change. This torque change must be added to the torque required for level flight for climb, or subtracted for descent, to obtain total climb or descent torque.

b. Rate of climb or descent may also be obtained by entering with a known torque change, moving upward to gross weight, moving left and reading rate of climb or descent.

c. To use the climb performance charts (fig. 7-95), enter at the top left at the known gross weight, move right to the initial press alt (pressure altitude), move down to the FAT at that altitude, and move left and record time, distance, and fuel. Enter again at the GW, move right to the final altitude, move down to the FAT at that altitude, and move left and record time, distance, and fuel. Subtract the time, distance, and fuel values of the initial altitude-temperature condition from those of the final altitude-temperature condition to find the time to climb, distance covered, and fuel used while climbing.

### 7-36. Conditions.

The climb and descent charts are based on 100% RRPM. The climb speed schedule shown in figure 7-95 (see insert) is for optimum climb, that is, minimum power required and maximum power available (30 minutes). It is an average schedule for the GW range and atmospheric conditions for the CH-47D.

### CLIMB/DESCENT

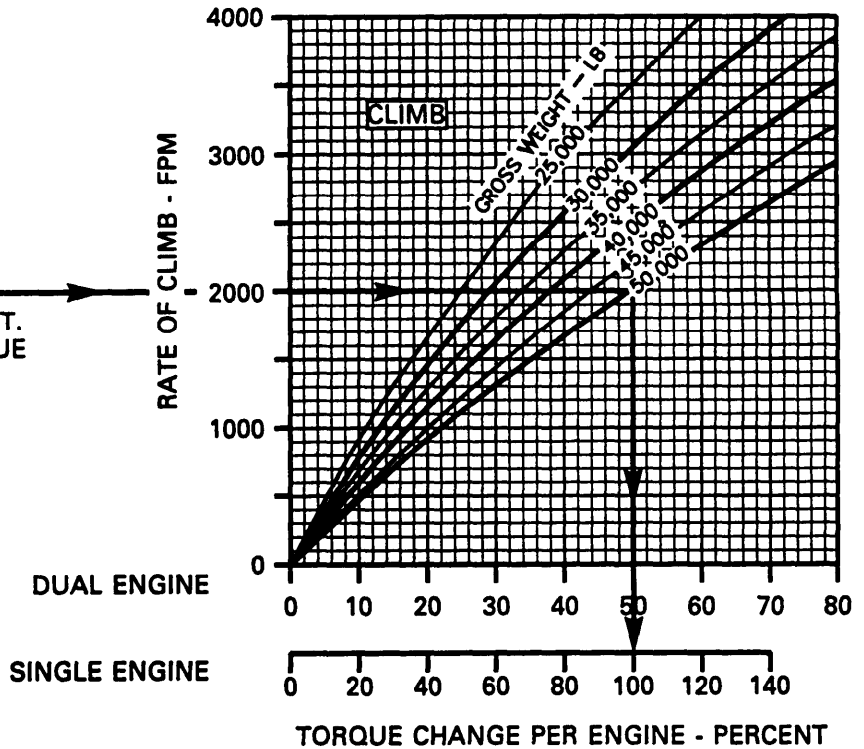
CLIMB/DESCENT  
CH-47D  
(2) T55-L-712

**EXAMPLE**

**WANTED**  
TORQUE CHANGE REQUIRED  
FOR DESIRED R/C OR R/D

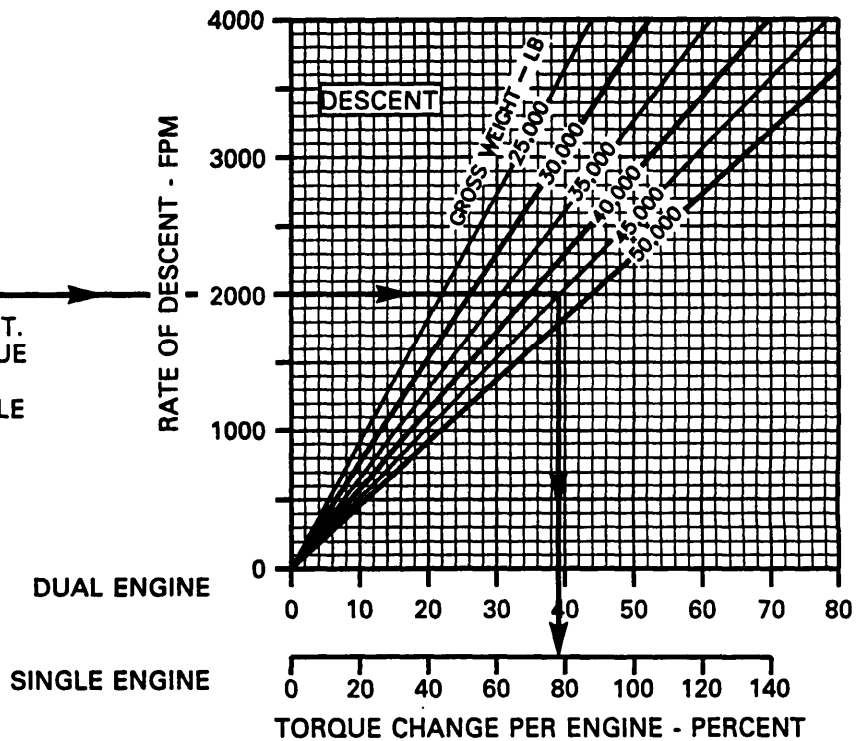
**KNOWN**  
GROSS WEIGHT = 50,000 LB  
DESIRED R/C = 2,000 FPM

**METHOD**  
ENTER DESIRED R/C HERE  
MOVE RIGHT TO GROSS WEIGHT.  
MOVE DOWN AND READ TORQUE  
CHANGE PER ENGINE = 50%  
DUAL ENGINE AND 100%  
SINGLE ENGINE  
OPERATION.



**KNOWN**  
GROSS WEIGHT = 45,000 LB  
DESIRED R/D = 2,000 FPM

**METHOD**  
ENTER DESIRED R/D HERE  
MOVE RIGHT TO GROSS WEIGHT.  
MOVE DOWN AND READ TORQUE  
CHANGE PER ENGINE = 39.0%  
DUAL ENGINE AND 78.0% SINGLE  
ENGINE OPERATION.



DATA BASIS: FLIGHT TEST

A21183

Figure 7-94. Climb - Descent Chart



# CLIMB PERFORMANCE

HOTTER TEMPERATURES

INTERMEDIATE TORQUE-30 MIN. OPERATION

100% ROTOR SPEED

CLIMB SPEED (SEE INSERT BELOW)

CLIMB  
CH-47D  
(2) T55-L-712

## EXAMPLE

### WANTED

TIME TO CLIMB  
DISTANCE TRAVELED  
CLIMB SPEED

### KNOWN

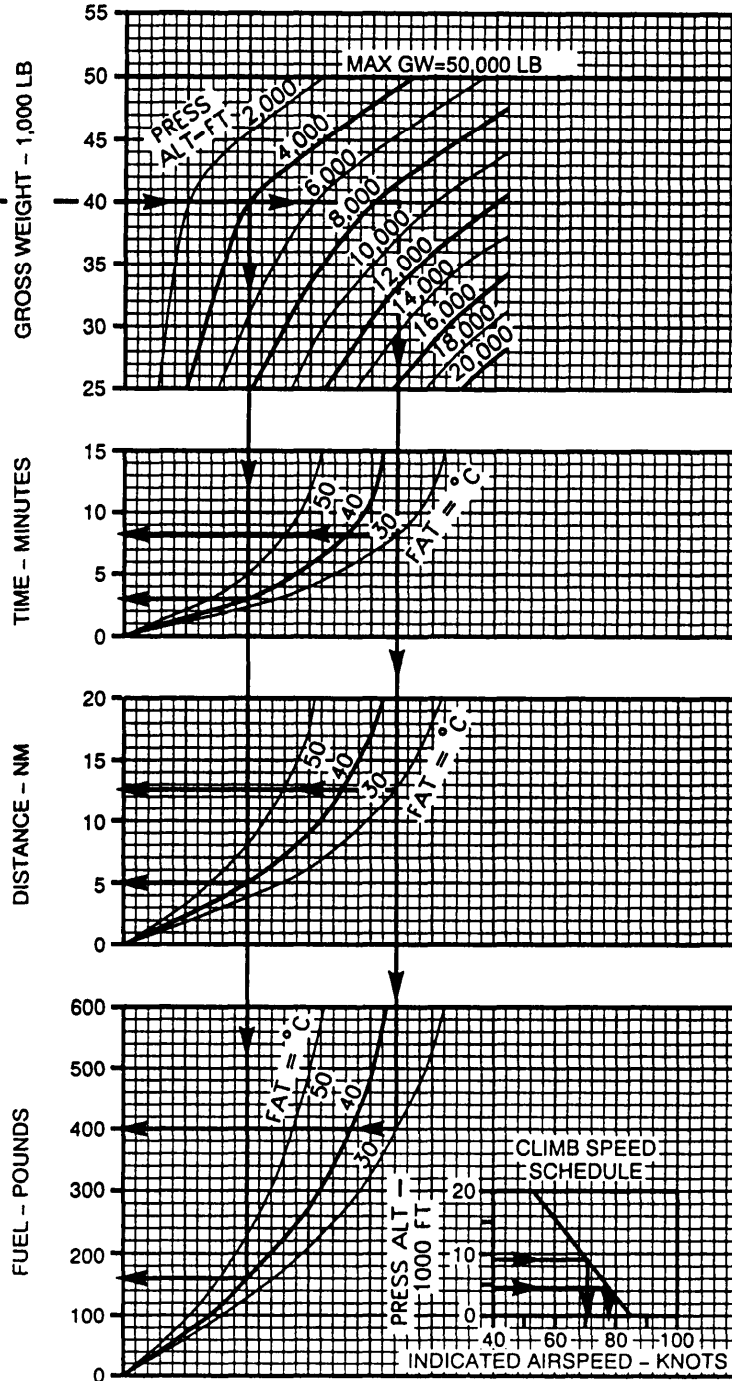
GROSS WEIGHT-40,000 LB  
INITIAL PRESS. ALT-4,000 FT  
FINAL PRESS. ALT-9,000 FT  
INITIAL FAT 40°C  
FINAL FAT ESTIMATED AT 30°C

### METHOD

ENTER GROSS WEIGHT HERE  
MOVE RIGHT TO INITIAL PRESS. ALT.  
MOVE DOWN TO INITIAL FAT ON  
TIME, DIST., AND FUEL CHARTS  
MOVE LEFT AND READ:  
TIME=3.1 MIN  
DIST.=5.0 NM  
FUEL=160 LB  
SPEED=79 KNOTS IAS (FROM INSERT)

REENTER AT SAME GROSS WEIGHT  
MOVE RIGHT TO FINAL PRESS. ALT.  
MOVE DOWN TO FINAL FAT ON  
TIME, DIST., AND FUEL CHARTS  
TIME=8.7 MIN  
DIST.=13.5 NM  
FUEL=400 LB

- TIME TO CLIMB=(8.7-3.1)=5.6 MIN
- DIST. COVERED=(13.5-5.0)=8.5 NM
- FUEL USED=(400-160)=240 LB



DATA BASIS: FLIGHT TEST

A21261

Figure 7-95. Climb Performance (Sheet 1 of 2)

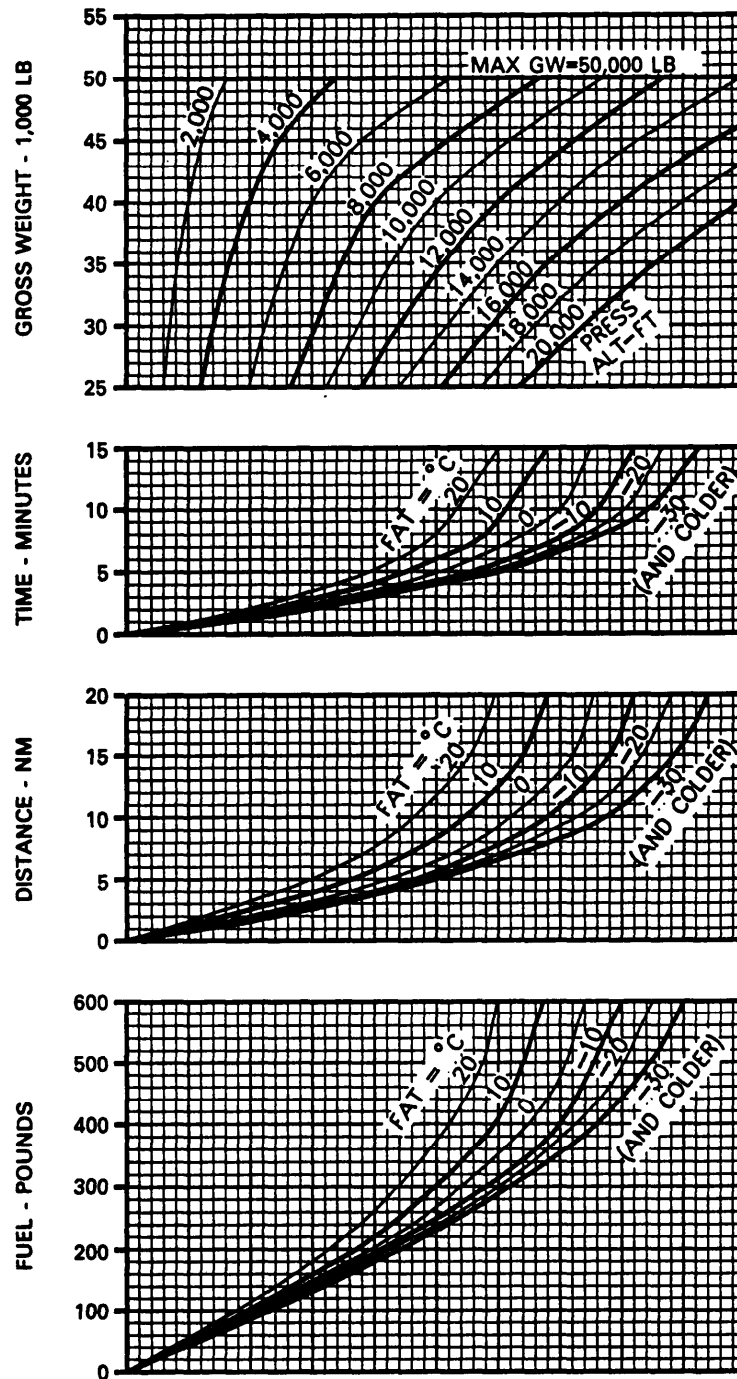
# CLIMB PERFORMANCE

COLDER TEMPERATURES

INTERMEDIATE TORQUE-30 MIN. OPERATION

100% ROTOR SPEED

CLIMB  
CH-47D  
(2) T55-L-712



DATA BASIS: FLIGHT TEST

A21288

Figure 7-95. Climb Performance (Sheet 2 of 2)

## SECTION X FUEL FLOW

### 7-37. Description.

The idle fuel flow chart (fig. 7-96) presents engine fuel flow sensitivity to PA and FAT for ground idle and flight idle.

### 7-38. Use of Chart.

The primary use of the charts is illustrated by the example. To determine idle fuel flow, it is necessary to know idle condition, PA, and FAT. Enter PA, move right to FAT, move down and read fuel flow.

### 7-39. Conditions.

- a. Presented charts are based on the use of JP-4 fuel.
- b. Ground idle is defined at **60** to **63** percent N1.
- c. Ground detent minimum beep is defined as engine condition levers at FLT, minimum beep, and thrust control at the detent.
- d. The single engine fuel flow chart (fig. 7-97) baseline is 0°C. Increase or decrease fuel flow by 1% for every 10°C change in temperature.

# IDLE FUEL FLOW

JP-4 FUEL

**IDLE FUEL FLOW**  
CH-47D  
T55-L-712

**WANTED**

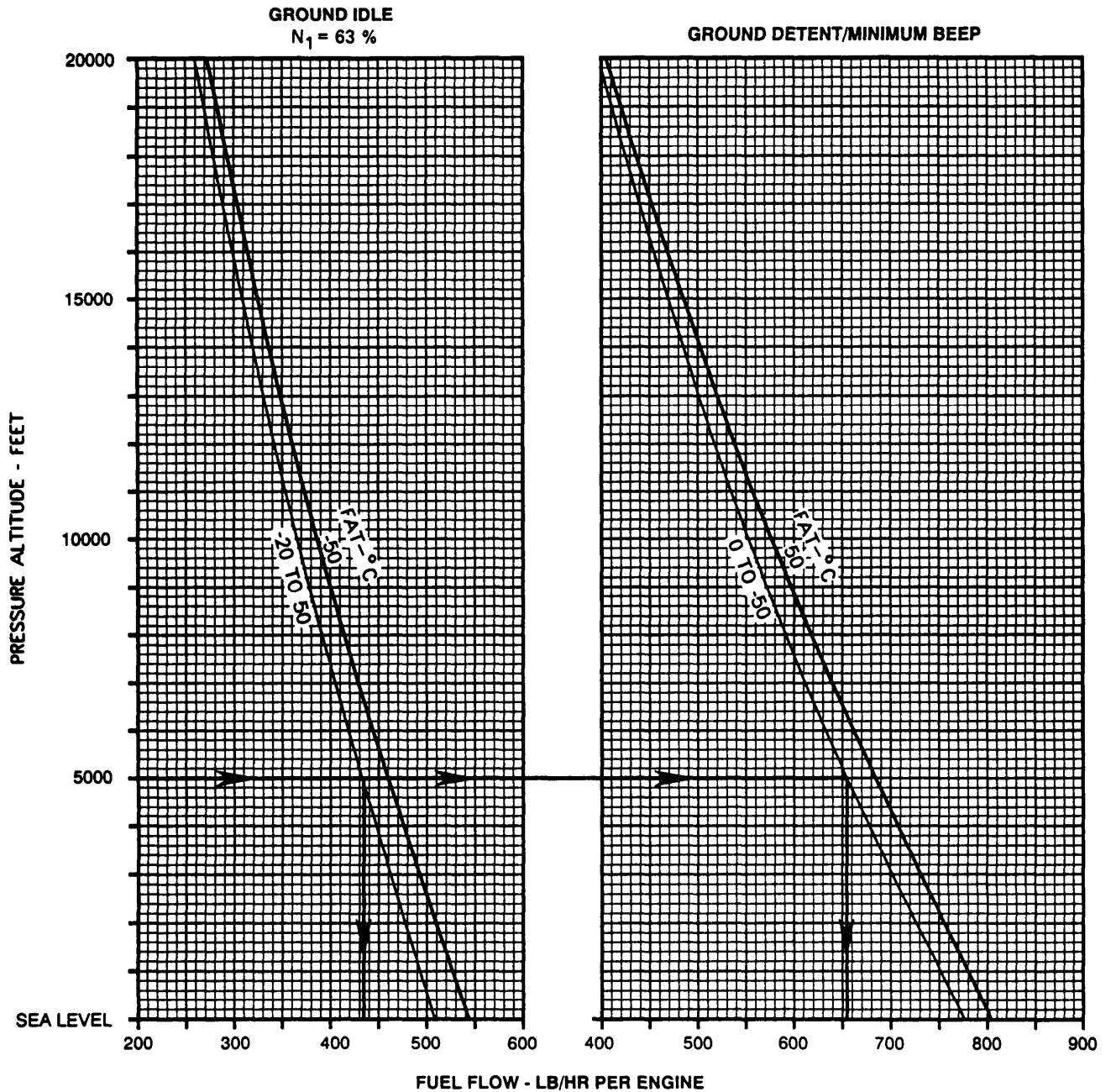
IDLE FUEL FLOW AT GROUND IDLE AND MINIMUM BEEP

**KNOWN**

PRESSURE ALTITUDE = 5000 FT/FAT = 0°C

**METHOD**

ENTER PRESSURE ALTITUDE AT 5000 FT. MOVE RIGHT TO FAT.  
FOR GROUND IDLE AND MINIMUM BEEP, MOVE DOWN, READ GROUND  
IDLE FUEL FLOW = 435 LB/HR PER ENGINE AND MINIMUM BEEP FUEL  
FLOW = 657 LB/HR PER ENGINE.



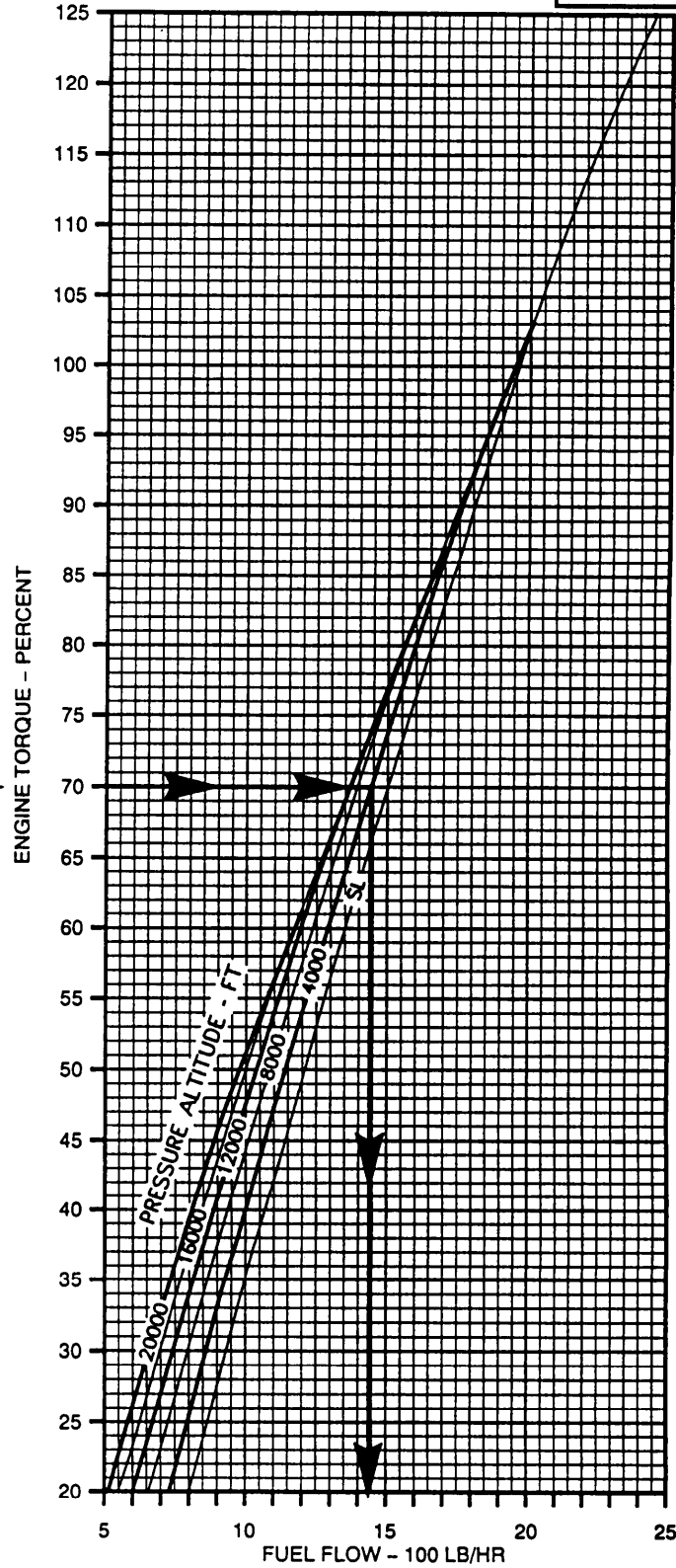
**DATA BASIS:** CALCULATED FROM MODEL SPEC. NO.124.53(B)

A19325

Figure 7-96. Idle Fuel Flow Chart

**SINGLE ENGINE FUEL FLOW**  
**BLEED-AIR OFF 100% ROTOR RPM**  
**FAT=0°C**

**SINGLE ENGINE FUEL FLOW**  
**CH-47D**  
**T55-L-712**



**EXAMPLE**  
**WANTED**  
 SINGLE ENGINE FUEL FLOW

**KNOWN**  
 TORQUE = 70%  
 PRESSURE ALTITUDE = 4000 FEET  
 FAT = 10°C

**METHOD**  
 ENTER AT 70% TORQUE HERE  
 MOVE RIGHT TO 4000 FEET  
 PRESSURE ALTITUDE, THEN DOWN  
 AND READ 1440 LB/HR FUEL FLOW.  
 SINCE FAT IS 10° ABOVE THE  
 BASELINE OF THIS CHART,  
 INCREASE FUEL FLOW BY 1%  
 FOR EVERY 10°C  
 $1440 \times .01 = 14.4$  POUNDS/HR  
 $1440 + 14.4 = 1454.4$  POUNDS/HR

**NOTE**  
 BASELINE IS 0°C  
 INCREASE OR DECREASE FUEL  
 FLOW BY 1% FOR EVERY  
 10°C CHANGE IN TEMP

DATA BASIS: CALCULATED

A21214

Figure 7-97. Single Engine Fuel Flow Chart



## SECTION XI AIRSPEED CALIBRATION

### 7-40. Description.

The airspeed calibration chart, figure 7-98, defines the relationship between indicated (IAS), and calibrated airspeed (CAS) for level flight, climb, and autorotation.

### 7-41. Use of Chart.

The primary use of the chart is illustrated by the example. To determine calibrated airspeed, it is necessary to know IAS and flight regime. Enter chart at

indicated airspeed, move right to appropriate flight regime, move down and read calibrated airspeed.

### 7-42. Conditions.

Presented airspeed calibration charts are for CH-47D helicopters with T55-L-712 engines.

# AIRSPEED CALIBRATION

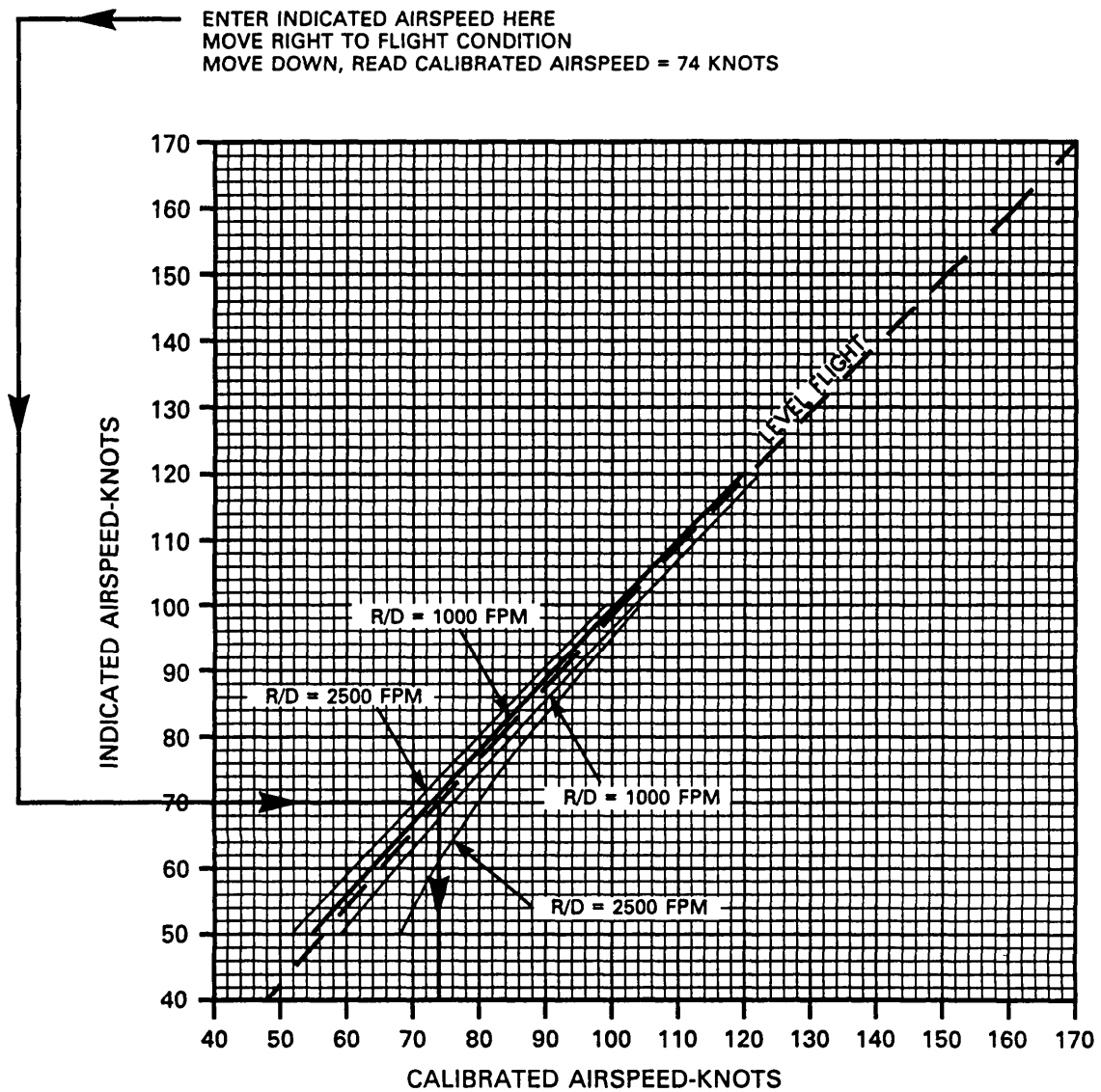
**AIRSPEED  
CH-47D**

**EXAMPLE**

**WANTED**  
CALIBRATED AIRSPEED

**KNOWN**  
INDICATED AIRSPEED = 70 KNOTS  
FLIGHT CONDITION = LEVEL FLIGHT

**METHOD**



DATA BASIS: FLIGHT TEST

A19320

Figure 7-98. Airspeed Calibration Chart



## CHAPTER 7A

### 714A PERFORMANCE DATA

#### SECTION I INTRODUCTION

##### 7A-1. Purpose.

The purpose of this chapter is to provide the best available performance data for the CH-47D helicopter. Regular use of this information will enable you to receive maximum safe utilization from the aircraft. Although maximum performance is not always required, regular use of this chapter is recommended for the following reasons.

- a. Knowledge of your performance margin will allow you to make better decisions when unexpected conditions or alternate missions are encountered.
- b. Situations requiring maximum performance will be more readily recognized.
- c. Familiarity with the data will allow performance to be computed more easily and quickly.
- d. Experience will be gained in accurately estimating the effects of variables for which data are not presented.

##### 7A-2. General Data.

The data presented covers the maximum range of conditions and performance that can reasonably be expected. In each area of performance, the effects of altitude, temperature, gross weight (GW), and other parameters relating to that phase of flight are presented. In addition to the presented data, your judgment and experience will be necessary to accurately obtain performance under a given set of circumstances. The conditions for the data are listed under the title of each chart. The effects of different conditions are discussed in the text accompanying each phase of performance. Where practical, data is presented at conservative conditions. However, **NO GENERAL CONSERVATISM HAS BEEN APPLIED**. All performance data presented is within the applicable limits of the aircraft.

#### CAUTION

**Exceeding operating limits can cause permanent damage to critical components. Over limit operation can decrease performance, cause immediate failure, or failure on a subsequent flight.**

##### 7A-3. Limits.

Applicable limit lines are shown on the charts. The dashed lines on the cruise charts are estimated airspeed limits with an operating cruise guide indicator (CGI). Airspeed limits with the CGI inoperative are in Chapter 5. If limits are exceeded, minimize the degree and time.

##### 7A-4. Use of Charts.

a. *Chart Explanation.* The first page of each section describes the chart(s) and explains its use.

b. The primary use of each chart is given in an example and a guideline is provided to help you follow the route through the chart. The use of a straight edge (ruler or page edge) and a hard fine point pencil is recommended to avoid cumulative errors. The majority of the charts provide a standard pattern for use as follows: enter first variable on top left scale, move right to the second variable, deflect down at right angles to the third variable, deflect left at right angles to the fourth variable, deflect down, etc. until the final variable is read out at the final scale. In addition to the primary use, other uses of each chart are explained in the text accompanying each set of performance charts.

#### NOTE

An example of an auxiliary use of the charts referenced above is as follows: Although the hover chart is primarily arranged to find torque required to hover, by entering torque available as torque required, maximum wheel height for hover can also be found. In general, any single variable can be found if all others are known. Also, the tradeoffs between variables can be found. For example, at a given pressure altitude (PA), you can find the maximum GW capability as free air temperature (FAT) changes.

c. *Dashed Line Data.* Data beyond conditions for which tests were conducted, or for which estimates are used, are shown as dashed lines.

##### 7A-5. Data Basis.

The type of data used is indicated at the bottom of each performance chart under DATA BASIS. The applicable report and date of the data are also given. The data provided generally is based on one of the following categories.

a. *Flight Test Data.* Data obtained by flight test of the aircraft by experienced flight test personnel at precise conditions using sensitive calibrated instruments.

b. *Calculated Data.* Data based on tests, but not on flight test of the complete aircraft.

c. *Estimated Data.* Data based on estimates using aerodynamic theory or other means but not verified by flight test.

##### 7A-6. Specific Conditions.

The data presented is accurate only for specific conditions listed under the title of each chart. Variables for which data

are not presented, but which may affect that phase of performance, are discussed in the text. Where data is available or reasonable estimates can be made, the amount that each variable affects performance will be given.

#### **7A-7. General Conditions.**

In addition to the specific conditions, the following general conditions are applicable to the performance data.

a. *Rigging.* All airframe and engine controls are assumed to be rigged within allowable tolerances.

b. *Pilot Technique.* Normal pilot technique is assumed.

c. *Aircraft Variation.* Variations in performance between individual aircraft are known to exist; however, they are considered to be small and cannot be accounted for individually.

d. *Instrument Variations.* The data shown in the performance charts does not allow for instrument inaccuracies or malfunctions.

e. *Airspeed Calibrations.* The airspeed calibration chart presents the difference between indicated air speed (IAS), and calibrated airspeeds (CAS) for different flight conditions.

f. Except as noted, all data is for a clean configuration (all doors installed, without armament).

g. *Types of Fuel.* All flight performance data is based on JP-5 fuel. The change in fuel flow and torque available, when using JP-4, JP-8, Aviation gasoline or any other approved fuels, is insignificant.

#### **7A-8. Performance Discrepancies.**

Regular use of this chapter will allow you to monitor instruments and other aircraft systems for malfunction, by comparing actual performance with planned performance. Knowledge will also be gained concerning the effects of variables for which data are not provided, thereby increasing the accuracy of performance predictions.

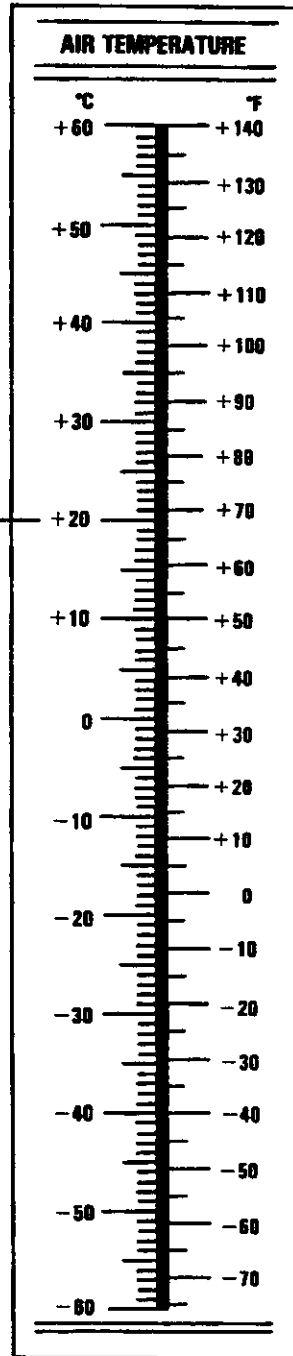
#### **7A-9. Definitions of Abbreviations.**

Capitalization and punctuation of abbreviations varies, depending upon the context in which they are used. In general, full capital letter abbreviations are used in text material, charts and illustrations. Periods do not usually follow abbreviations; however, periods are used with abbreviations that could be mistaken for whole words if the period were omitted.

TEMPERATURE  
CONVERSION

# TEMPERATURE CONVERSION CHART

**EXAMPLE**  
**WANTED**  
 FAT IN DEGREES FARENHEIT °F  
**KNOWN**  
 FAT = 20°C  
**METHOD**  
 ENTER FAT (°C) HERE →  
 MOVE RIGHT AND READ  
 FAT = 68°F



16017

Figure 7A-1. Temperature Conversion Chart

## SECTION II CONTINGENCY TORQUE AVAILABLE

### 7A-10. Contingency Torque Available.

Single engine and dual engine contingency torque available may be obtained from figure 7A-2. Available torque is presented in terms of PA and FAT.

### 7A-11. Use of Chart.

The primary use of the chart is to determine available engine torque for various combinations of PA and temperature. To determine torque available, it is necessary to know

PA, and FAT. Enter the left side of the chart at known temperature, move right to known pressure altitude, then down to read torque available.

### 7A-12. Conditions.

The chart is based on a rotor speed of 100%.

### CONTINGENCY TORQUE AVAILABLE

100% ROTOR RPM

TAS=0 KN

CONTINGENCY TORQUE  
CH-47D  
(2) T55-GA-714A

**EXAMPLE**

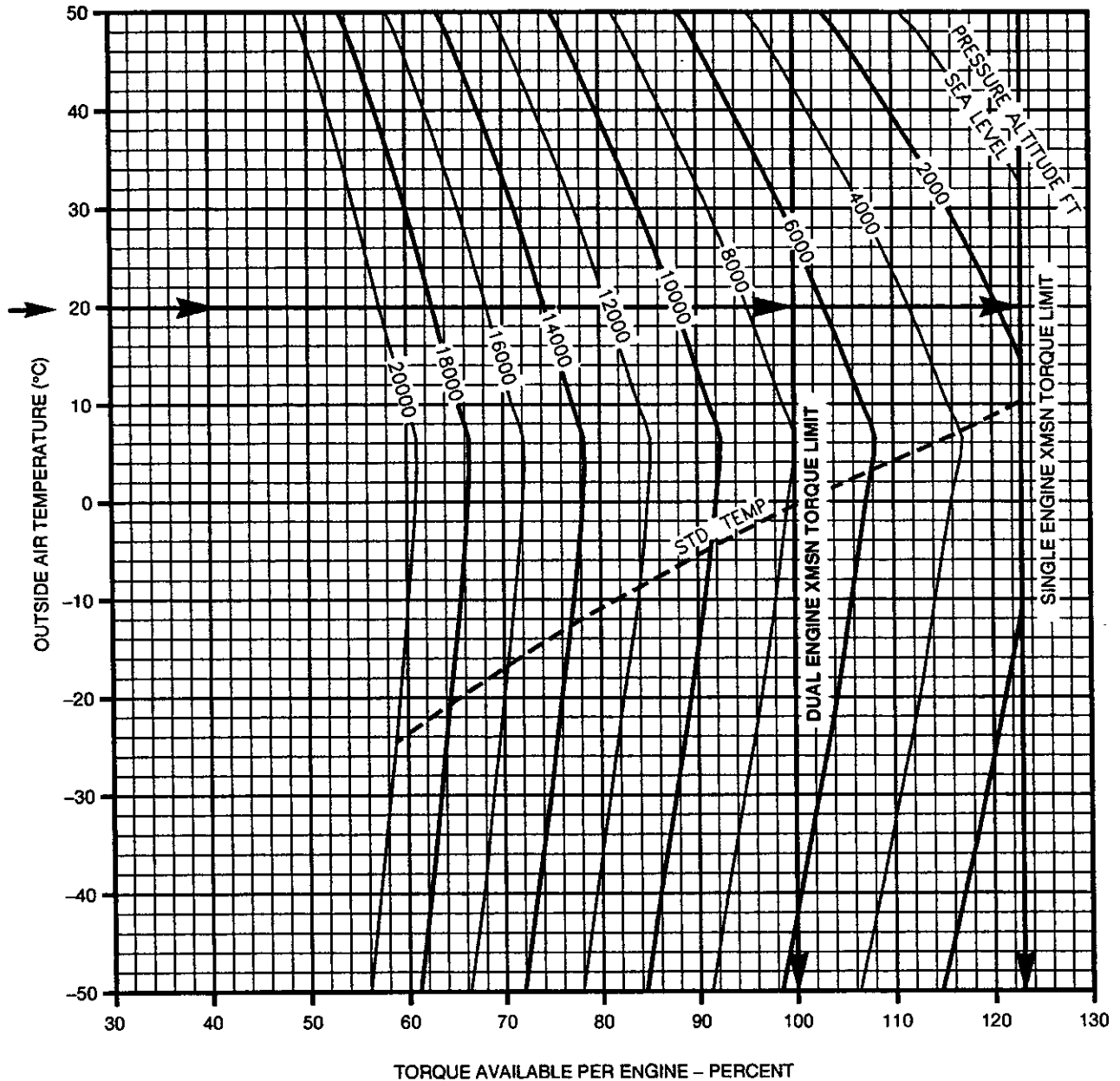
**WANTED**  
CONTINGENCY TORQUE AVAILABLE

**KNOWN**

PRESSURE ALTITUDE = SEA LEVEL/FAT = 20°C

**METHOD**

ENTER FAT AT 20 °C MOVE RIGHT TO  
PRESSURE ALTITUDE = SEA LEVEL  
MOVE DOWN TO READ CONTINGENCY TORQUE  
AVAILABLE PER ENGINE = 123.0 PERCENT



DATA BASIS: CALCULATED FROM MODEL SPEC LES-714A-93-01 AND FLIGHT TEST

A60105

Figure 7A-2. Contingency Torque Available

### SECTION III MAXIMUM TORQUE AVAILABLE

#### **7A-13. Maximum Torque Available (10-Minute Operation).**

Maximum torque available (10-minute operation) may be obtained from figure 7A-3. Available torque is presented in terms of pressure altitude and free air temperature.

#### **7A-14. Use of Chart.**

The primary use of the chart is to determine available engine torque for various combinations of pressure altitude and temperature. To determine torque available, it is necessary to know pressure altitude and free air temperature. Enter the left side of the chart at known temperature, move right to known pressure altitude, then down to read torque available.

#### **7A-15. Conditions.**

The chart is based on a rotor speed of 100%.

#### **7A-16. Intermediate Torque Available (30-Minute Operation).**

Maximum torque available (30-minute operation) may be obtained from figure 7A-4. Available torque is presented in terms of PA and FAT.

#### **7A-17. Use of Chart.**

The primary use of the chart is to determine available engine torque for various combinations of PA and temperature. To determine torque available, it is necessary to know pressure altitude and free air temperature. Enter the left side of the chart at the known pressure altitude, move right to known temperature, then down to read intermediate torque available.

#### **7A-18. Conditions.**

The chart is based on a rotor speed of 100%.

## MAXIMUM TORQUE AVAILABLE (10 MIN. OPERATION)

100% ROTOR RPM

TAS=0 KN

MAXIMUM TORQUE  
CH-47D  
(2) T55-GA-714A

**EXAMPLE**

**WANTED**

MAXIMUM TORQUE AVAILABLE FOR SINGLE AND DUAL ENGINE OPERATION

**KNOWN**

PRESSURE ALTITUDE = SEA LEVEL  
/FAT = 20°C

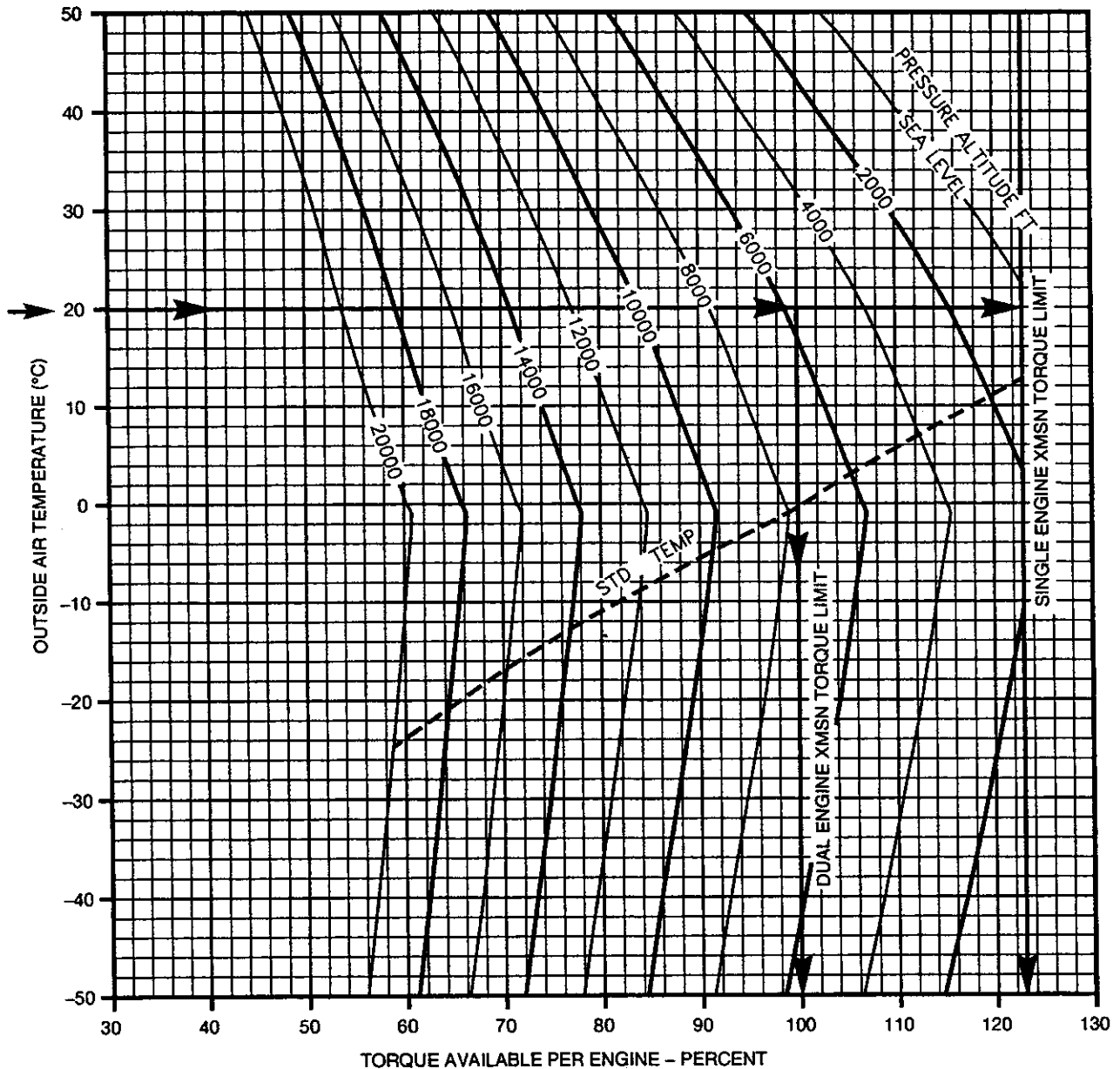
**METHOD**

**SINGLE ENGINE OPERATION**

ENTER FAT AT 20°C MOVE RIGHT TO PRESSURE ALTITUDE = SEA LEVEL  
MOVE DOWN READ MAXIMUM TORQUE AVAILABLE PER ENGINE = 123.0 PERCENT

**DUAL ENGINE OPERATION**

ENTER FAT AT 20°C MOVE RIGHT TO PRESSURE ALTITUDE = SEA LEVEL  
OR DUAL ENGINE XMSN TORQUE LIMIT. MOVE DOWN READ MAXIMUM  
TORQUE AVAILABLE PER ENGINE = 100.0 PERCENT



DATA BASIS: CALCULATED FROM MODEL SPEC LES-714A-93-01 AND FLIGHT TEST

A60106

**Figure 7A-3. Maximum Torque Available (10-Minute Operation)**

## INTERMEDIATE TORQUE AVAILABLE (30 MIN OPERATION)

100% ROTOR RPM

TAS=0 KN

INTERMEDIATE TORQUE  
CH-47D  
(2) T55-GA-714A

**EXAMPLE**

**WANTED**

INTERMEDIATE TORQUE AVAILABLE FOR SINGLE AND DUAL ENGINE OPERATION

**METHOD**

**SINGLE ENGINE OPERATION**

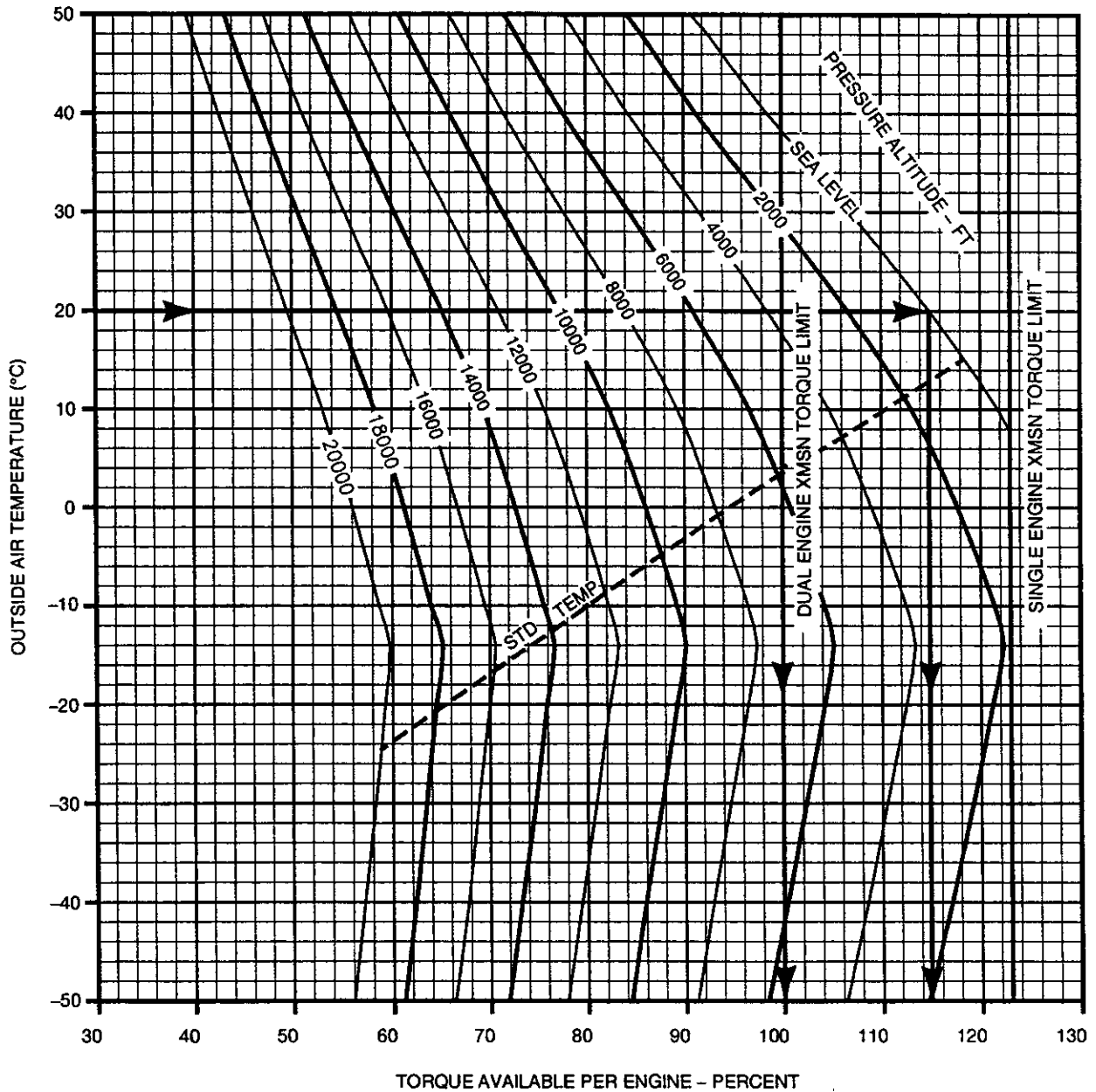
ENTER FAT AT 20°C MOVE RIGHT TO PRESSURE ALTITUDE = SEA LEVEL  
MOVE DOWN, READ TORQUE AVAILABLE  
PER ENGINE = 114.9 PERCENT

**DUAL ENGINE OPERATION**

ENTER FAT AT 20°C MOVE RIGHT TO PRESSURE ALTITUDE = SEA LEVEL  
MOVE DOWN, READ MAXIMUM TORQUE AVAILABLE  
PER ENGINE = 100.0 PERCENT

**KNOWN**

PRESSURE ALTITUDE = SEA LEVEL/FAT = 20°C



DATA BASIS: CALCULATED FROM MODEL SPEC LES-714A-93-01 AND FLIGHT TEST

A60107

**Figure 7A-4. Intermediate Torque Available (30-Minute Operation)**



## SECTION IV CONTINUOUS TORQUE AVAILABLE

### 7A-19. Continuous Torque Available.

Continuous torque available may be obtained from figure 7A-5. Available torque is presented in terms of PA and FAT.

### 7A-20. Use of Chart.

The primary use of the chart is to determine available engine torque for various combinations of PA and temperature. To determine torque available, it is necessary to know

PA and FAT. Enter the left side of the chart at known temperature, move right to known pressure altitude, then down to read torque available.

### 7A-21. Conditions.

The chart is based on a rotor speed of 100%.

### CONTINUOUS TORQUE AVAILABLE

CONTINUOUS TORQUE  
CH-47D  
(2) T55-GA-714A

100% ROTOR RPM

TAS=0 KN

**EXAMPLE**

**WANTED**

CONTINUOUS TORQUE AVAILABLE  
FOR SINGLE AND DUAL  
ENGINE OPERATION

**METHOD**

**SINGLE ENGINE OPERATION**

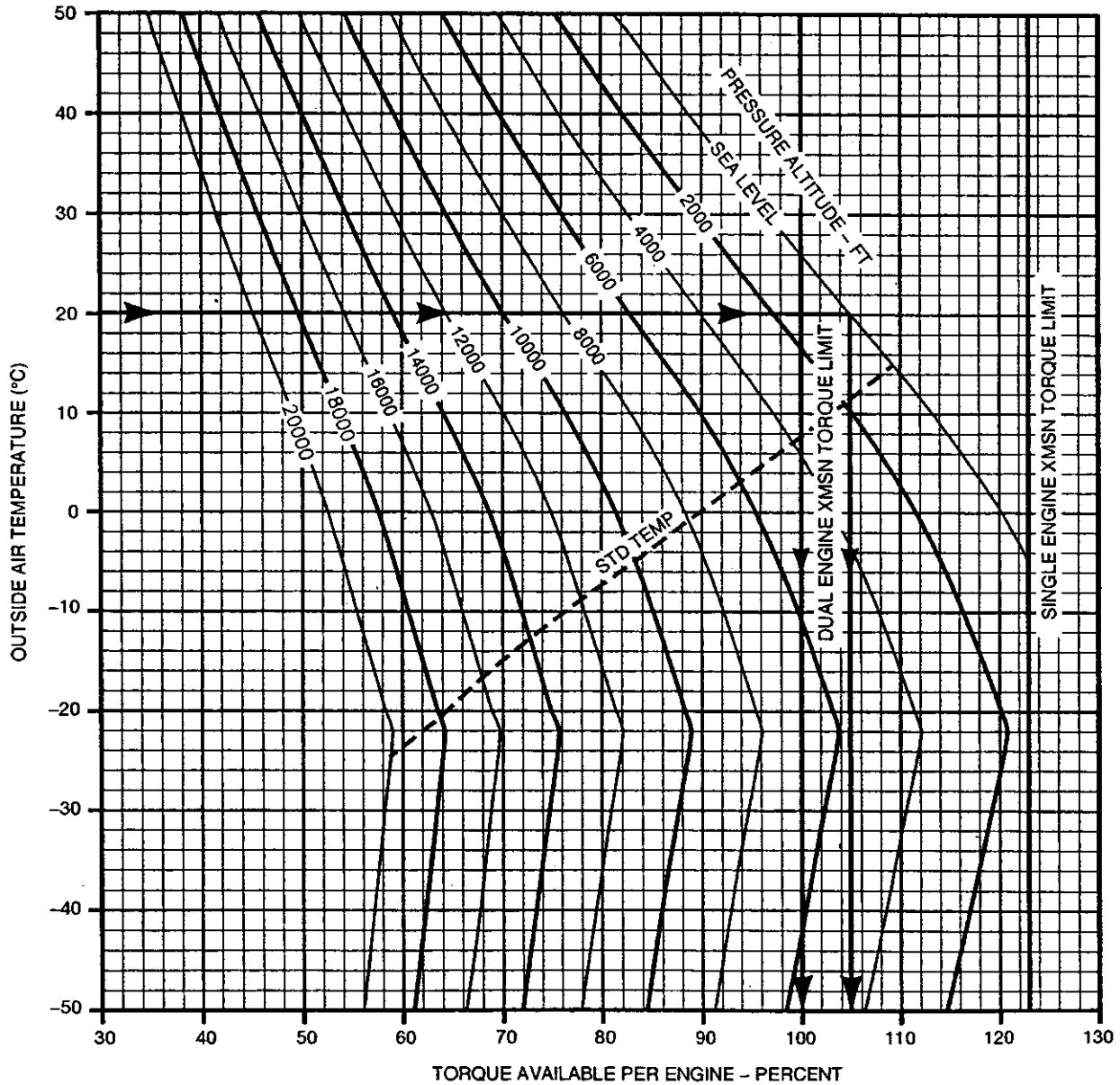
ENTER FAT AT 20°C MOVE RIGHT TO PRESSURE ALTITUDE = SEA LEVEL  
MOVE DOWN READ CONTINUOUS TORQUE AVAILABLE PER ENGINE = 105.0 PERCENT

**KNOWN**

PRESSURE ALTITUDE =  
SEA LEVEL/FAT = 20°C

**DUAL ENGINE OPERATION**

ENTER FAT AT 20°C MOVE RIGHT TO PRESSURE ALTITUDE = SEA LEVEL  
MOVE DOWN READ CONTINUOUS TORQUE AVAILABLE PER ENGINE = 100.0 PERCENT



DATA BASIS: CALCULATED FROM MODEL SPEC LES-714A-93-01 AND FLIGHT TEST

A60108

Figure 7A-5. Continuous Torque Available

## SECTION V HOVER

### 7A-22. DESCRIPTION.

The hover chart, figure 7A-6, presents torque required to hover at 100% RRPM at various combinations of PA, FAT, GW, and wheel height for single and dual engine operation.

### 7A-23. Use of Chart.

a. The primary use of the charts is illustrated by the example. To determine the torque required to hover, it is necessary to know PA, FAT, GW, and desired wheel height. Enter the upper right grid at the known pressure altitude, move right to the temperature, move down to gross weight. Move left to desired wheel height, deflect down and read torque required for dual engine or single engine operation.

b. In addition to the primary use, the hover ceiling charts (fig. 7A-7) may be used to predict maximum hover height. This information is necessary for use of the takeoff chart found in figure 7A-8. To determine maximum hover height, it is necessary to know PA, FAT, GW, and maximum torque available. Enter at the known pressure altitude, move right to FAT, move down to gross weight, move left to intersection with maximum torque available and read wheel height. This wheel height is the maximum hover height.

c. The hover charts may also be used to determine maximum GW for hover at a given wheel height, PA, and temperature. Enter at known pressure altitude, move right to the FAT, then move down to the bottom of the lower grid, and read density altitude. Now enter lower left grid at maximum torque available. Move up to wheel height, then move right to density altitude and read GW. This is the maximum gross weight at which the helicopter will hover.

### 7A-24. Conditions.

a. The hover chart is based on calm wind, level surface, and 100% RRPM.

b. Hover in ground effect (HIGE) data is based on hovering over a level surface. For normal transition from hover to forward flight, the minimum hover wheel height should be 10 feet to prevent ground contact. If helicopter is to hover over a surface known to be steep, covered with vegetation, or if type of terrain is unknown, the flight should be planned for hover out of ground effect (HOGE) capability.

# HOVER

100% ROTOR RPM

CALM WIND

LEVEL SURFACE

HOVER  
CH-47D  
(2) T55-GA-714A

## EXAMPLE

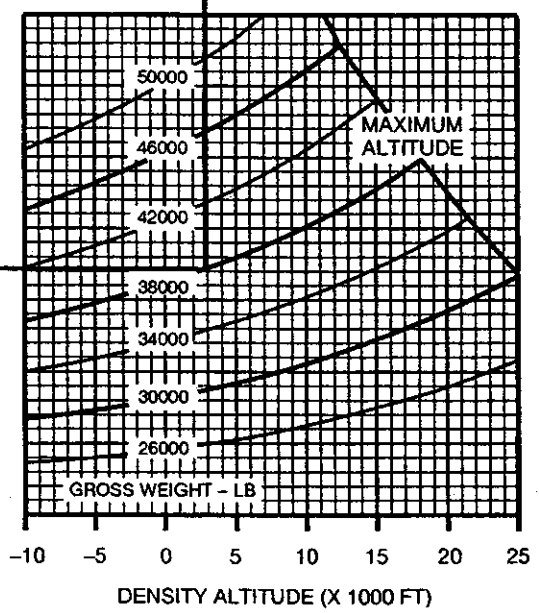
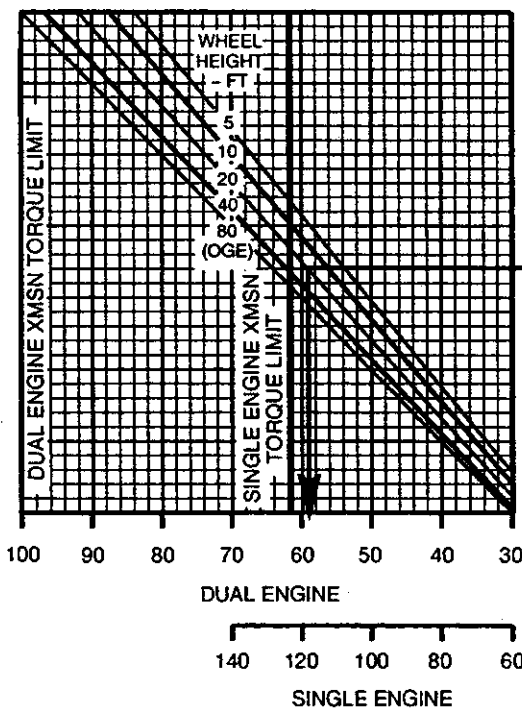
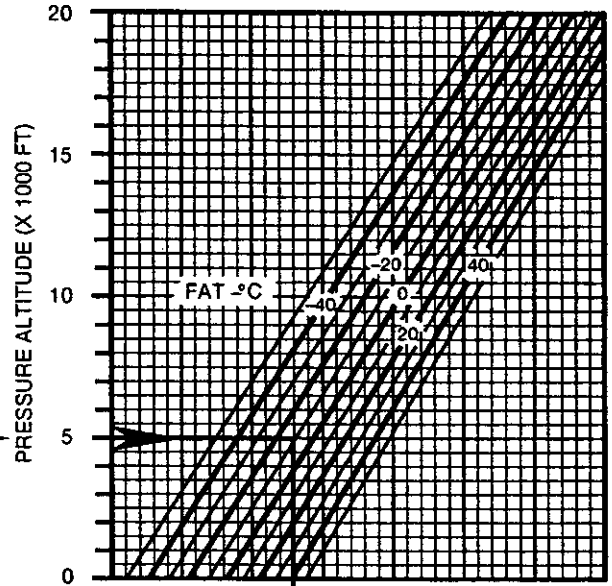
**WANTED**  
TORQUE REQUIRED TO HOVER

**KNOWN**  
PRESSURE ALTITUDE = 5000 FT/FAT = -10°C  
GROSS WEIGHT = 38000LB  
DESIRED WHEEL HEIGHT = 20 FT

**METHOD**  
ENTER PRESSURE ALTITUDE HERE →  
MOVE RIGHT TO FAT  
MOVE DOWN TO GROSS WEIGHT  
MOVE LEFT TO DESIRED WHEEL HEIGHT  
MOVE DOWN AND READ TORQUE REQ'D TO HOVER (PER ENGINE):  
59% (DUAL ENG OPERATION)  
118% (SINGLE ENG OPERATION)

**NOTE**  
WHEN OPERATING BELOW 0C INCREASE TORQUE REQ'D PER ENG BY:

0°C	-20°C	-40°C	-50°C
0%	1%	2%	3%



TORQUE REQUIRED PER ENGINE (PERCENT)

DATA BASIS: FLIGHT TEST

A60123

Figure 7A-6. Hover Chart

## MAXIMUM GROSS WEIGHT TO HOVER MAXIMUM POWER (10 MINUTES)

HOVER  
CH-47D  
(2) T55-GA-714A

100% ROTOR RPM

TAS=0 KN

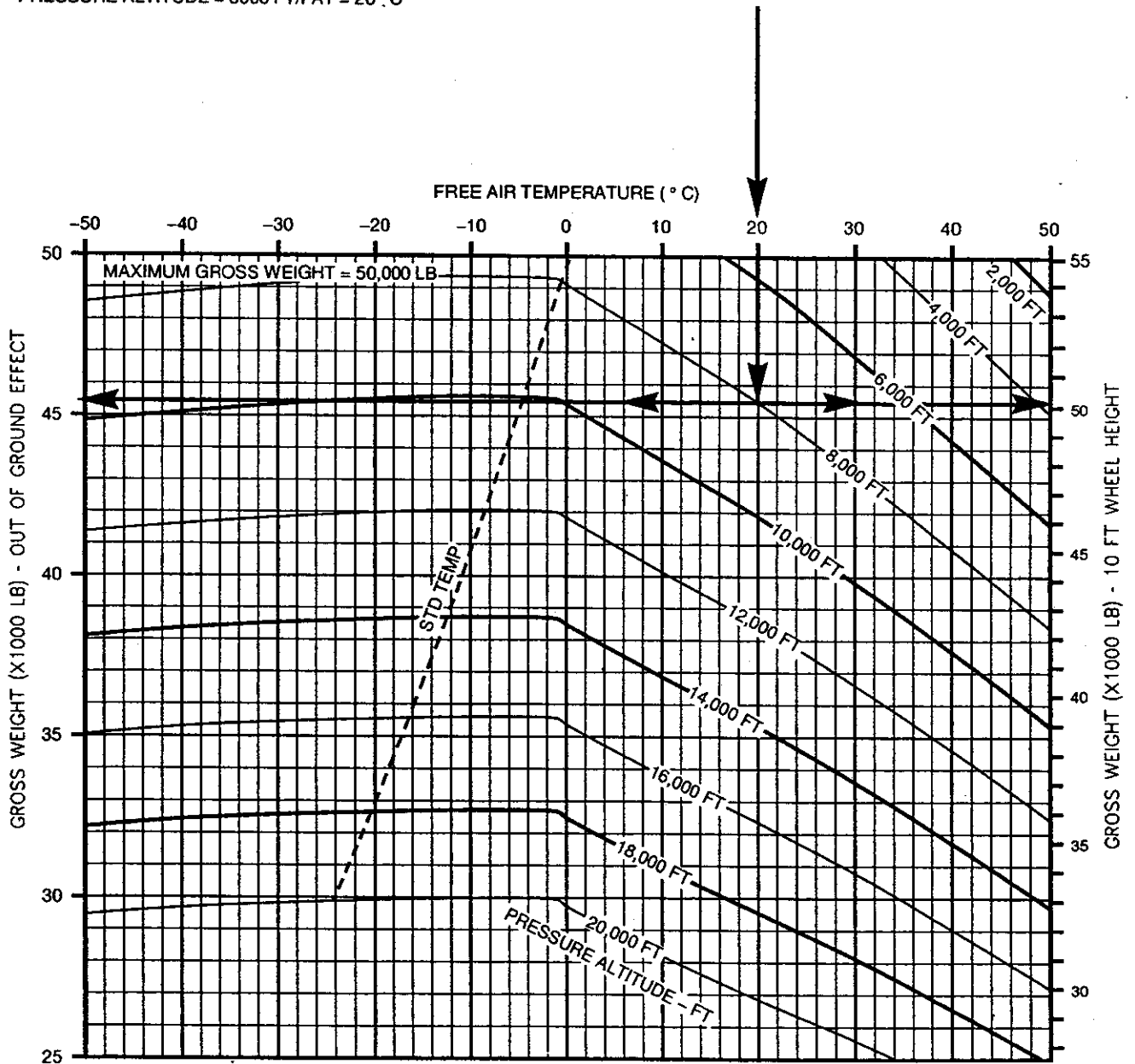
**EXAMPLE**

**WANTED**  
MAXIMUM GROSS WEIGHT TO HOVER

**KNOWN**  
PRESSURE ALTITUDE = 8000 FT/FAT = 20 °C

**METHOD**

ENTER FAT AT 20 °C MOVE RIGHT TO PRESSURE ALTITUDE = 8000 FT  
MOVE LEFT - READ MAX GROSS WEIGHT TO HOVER OUT OF  
GROUND EFFECT = 45450 LB  
OR  
MOVE RIGHT - READ MAX GROSS WEIGHT TO HOVER AT 10 FT  
WHEEL HEIGHT = 50030 LB



DATA BASIS: FLIGHT TEST

A60109

Figure 7A-7. Hover Ceiling

**SECTION VI TAKEOFF****7A-25. Description.**

The takeoff chart, figure 7A-8, defines distances required to clear obstacles of 50 feet, 100 feet, 150 feet, and 200 feet based upon maximum hover height capability and true airspeed. The procedure for takeoff is the level flight acceleration technique.

**NOTE**

The maximum hover heights shown are indicative of helicopter performance capability and do not imply that this hover height must be maintained through takeoff.

**7A-26. Use of Chart.**

The primary use of the chart is illustrated by the examples.

a. To determine the distance required to clear an obstacle, it is necessary to know maximum hover height (hover capability), obstacle height, and climbout true airspeed. Calculation of maximum hover height is described in Section V, Hover. Enter the chart for the required obstacle

height, move right to desired true climbout airspeed, then down and read distance required to clear obstacle.

b. A hover check should be made prior to takeoff to verify hover capability. If winds are present, hover capability will be greater than predicted since the hover chart is based on calm wind conditions.

**7A-27. Conditions.**

a. The takeoff chart is based on calm wind conditions. Since the surface wind velocity and direction cannot be accurately predicted, all takeoff planning should be based on calm air conditions. Takeoff into the wind will improve takeoff performance.

**CAUTION**

**A tailwind during takeoff and climbout will increase the distance for obstacle clearance and may prevent a successful takeoff.**

b. Takeoff performance data are based on the use of maximum torque available at 100% RRPM.

**TAKEOFF**

**LEVEL ACCELERATION TECHNIQUE**

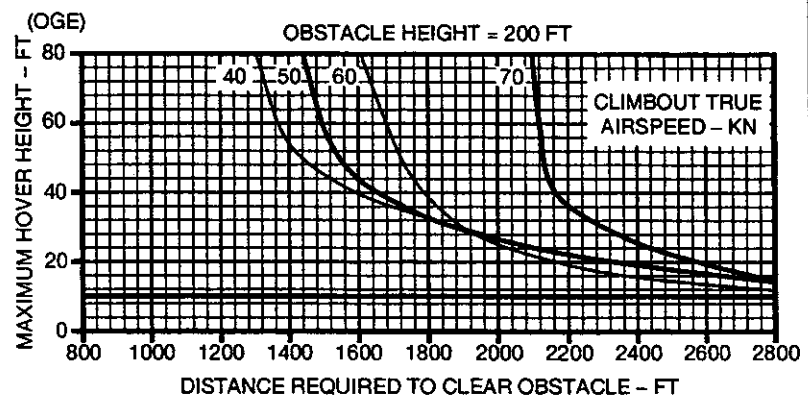
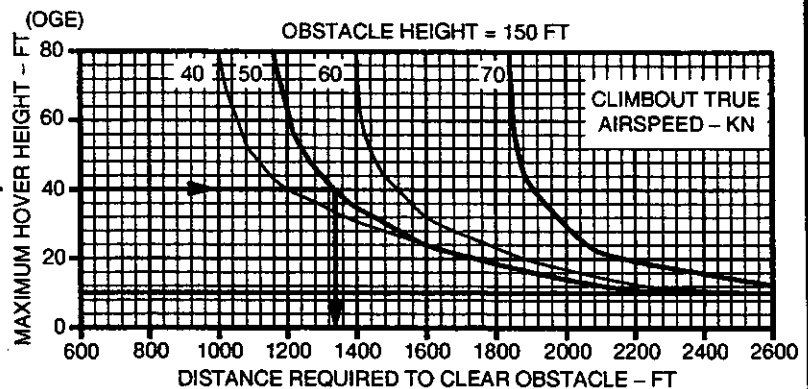
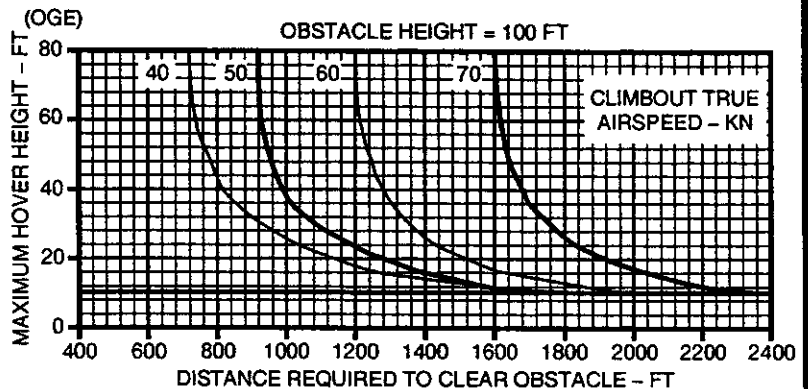
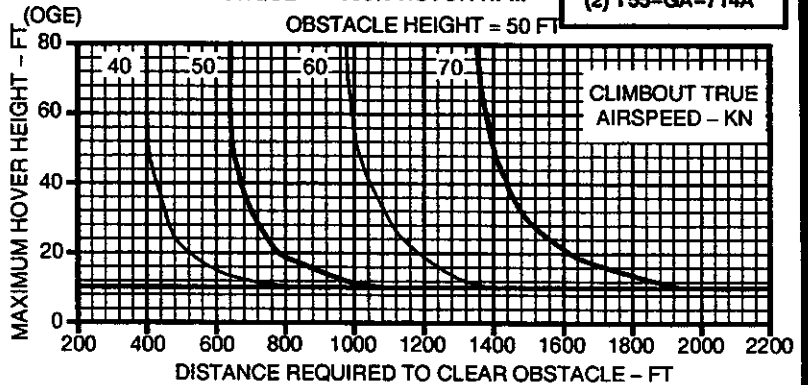
CALM WIND

LEVEL SURFACE

MAXIMUM TORQUE

100% ROTOR RPM

TAKEOFF  
CH-47D  
(2) T55-GA-714A



**EXAMPLE**

**WANTED**

DISTANCE TO CLEAR OBSTACLE

**KNOWN**

MAXIMUM HOVER HEIGHT = 40 FT

OBSTACLE HEIGHT = 125 FT

CLIMBOUT TRUE AIRSPEED = 50 KN

**METHOD 1 (Simplest)**

USE NEXT HIGHER OBSTACLE HEIGHT (150 FT)

ENTER MAX HOVER HEIGHT ON LEFT →

MOVE RIGHT TO CLIMBOUT TRUE AIRSPEED

MOVE DOWN AND READ DISTANCE TO CLEAR OBSTACLE = 1340 FT

**METHOD 2 (Interpolate)**

READ DISTANCE REQUIRED TO CLEAR OBSTACLE AT EACH ADJACENT OBSTACLE HEIGHT AND INTERPOLATE

OBSTACLE HEIGHT = 100 FT, 150 FT, 125 FT

DISTANCE REQUIRED = 1000 FT, 1340 FT, 1170 FT

DATA BASIS: FLIGHT TEST

A60118

Figure 7A-8. Takeoff Chart

## SECTION VII CRUISE

**7A-28. Description.**

The cruise charts, figures 7A-9 through 7A-92, present torque requirements and fuel flow for cruise flight as a function of airspeed and gross weight for various combinations of pressure altitude and free air temperature. Dot pattern (shaded) area indicates time limited operation.

**7A-29. Use of Charts.**

The primary use of charts is illustrated by the example cruise chart (fig. 7A-9). To use the charts it is usually necessary to know the planned PA, estimated FAT, planned cruise TAS, and the GW. First, select the proper chart based on PA and free air temperature. Enter the chart at the cruise TAS, move right and read IAS, move left to the GW, move down and read torque required, then move up and read associated fuel flow. Maximum performance conditions are determined by entering the chart where the maximum range line or maximum endurance and rate of climb (R/C) line intersect the gross weight line; then read airspeed, fuel flow, and torque required. Normally, sufficient accuracy can be obtained by selecting the chart nearest to the planned cruising altitude and FAT, or move conservatively, by selecting the chart with the next higher altitude and FAT (example cruise chart, method one). If greater accuracy is required, interpolation between altitudes and/or temperatures is permissible (example cruise chart, method two). To be conservative, use the GW at the beginning of the cruise flight. For improved accuracy or long flights, it is preferable to determine cruise information for several flight segments to allow for decreasing GW.

a. *Airspeed.* True and indicated airspeeds are presented at opposite sides of each chart. On any chart, IAS can be directly converted to TAS (or vice versa) by reading directly across the chart without regard to other chart information. Estimated airspeed limits with an **operating** CGI appear as dashed lines on each chart. Airspeed limits with the CGI **inoperative** are presented in the airspeed limits section of Chapter 5.

**NOTE**

Airspeed limitations with an operative cruise guide indicator are per the indicator display. Estimated values shown on these cruise charts are for information only, as an aid to pre-flight planning.

b. *Torque.* Since PA and temperature are defined for each chart, torque required varies only with GW and airspeed. The torque required per engine as presented on the charts is for dual engine operation. The torque required for single engine operation is double the dual engine torque value for any given condition. See cruise chart example 2 for example on torque required. The torque available limits shown are either transmission or engine torque limits (whichever is least).

c. *Fuel Flow.* The fuel flow scales presented on each chart opposite the torque scales are for dual engine operation. Torque may be converted directly to fuel flow on any chart without regard to other chart information. A single engine fuel flow chart is presented in Section X. Torque required for any given condition as obtained from the preceding cruise charts should be doubled before being used to obtain single engine fuel flow from this chart.

d. *Maximum Range.* Maximum range lines indicate optimum GW/cruise speed conditions with respect to distance covered per-pound of fuel consumed for zero wind condition.

e. *Maximum Endurance and Rate of Climb.* Maximum endurance and rate of climb lines indicate optimum GW/cruise speed conditions for maximum endurance and maximum rate of climb. These conditions require minimum fuel flow (maximum endurance) and provide maximum torque change for climb (maximum rate of climb).

**7A-30. Conditions.**

The cruise charts are based on 100% RRPM for ambient temperatures of  $-10^{\circ}\text{C}$  and above, and 98% and 100% RRPM for ambient temperatures of  $-20^{\circ}\text{C}$  and below.



**CRUISE EXAMPLE**

**EXAMPLE 1 (DUAL ENGINE)**

**WANTED:**

SPEED FOR MAXIMUM ENDURANCE  
 SPEED FOR MAXIMUM RANGE  
 MAX. SPEED AT CONTINUOUS TORQUE RATING  
 ESTIMATED AIRSPEED LIMIT WITH CRUISE GUIDE  
 INDICATOR (CGI) OPERATIVE

**KNOWN:**

GROSS WEIGHT= 50,000LB  
 PRESSURE ALTITUDE = SEA LEVEL  
 FAT = 30°C

**METHOD:**

READ SPEEDS WHERE GROSS WEIGHT LINE INTER-  
 SECTS PERFORMANCE OR LIMIT LINE  
 MAXIMUM ENDURANCE: TAS = 89 KN, IAS = 83 KN  
 MAXIMUM RANGE: TAS = 144 KN, IAS = 140 KN  
 MAXIMUM SPEED (CONTINUOUS TORQUE RAT-  
 ING): TAS = 152 KN, IAS = 149 KN  
 AIRSPEED LIMITED BY VCGI.

**EXAMPLE 2 (DUAL ENGINE)  
 (DASH LINE)**

**WANTED:**

TORQUE REQUIRED FOR LEVEL FLIGHT, FUEL  
 FLOW, AND INDICATED AIRSPEED AT TAS = 120KN.

**KNOWN:**

GROSS WEIGHT = 45,000 LB.  
 PRESSURE ALTITUDE = SEA LEVEL  
 FAT = 35°C  
 TRUE AIRSPEED = 120 KN.

**METHOD 1 (SIMPLEST):**

USE NEXT HIGHER TEMPERATURE (40°C)  
 ENTER TAS, MOVE RIGHT TO GROSS WEIGHT  
 MOVE DOWN READ TORQUE REQ'D = 55% (PER  
 ENGINE)  
 MOVE UP READ FUEL FLOW = 2,600 LB/HR (TOTAL)  
 MOVE RIGHT READ IAS = 114 KN

**METHOD 2 (INTERPOLATE):**

READ TORQUE REQUIRED, FUEL FLOW, AND IAS AT  
 EACH ADJACENT TEMPERATURE THEN INTERPO-  
 LATE BETWEEN TEMPERATURES

(REFER TO THE TABLE BELOW.)

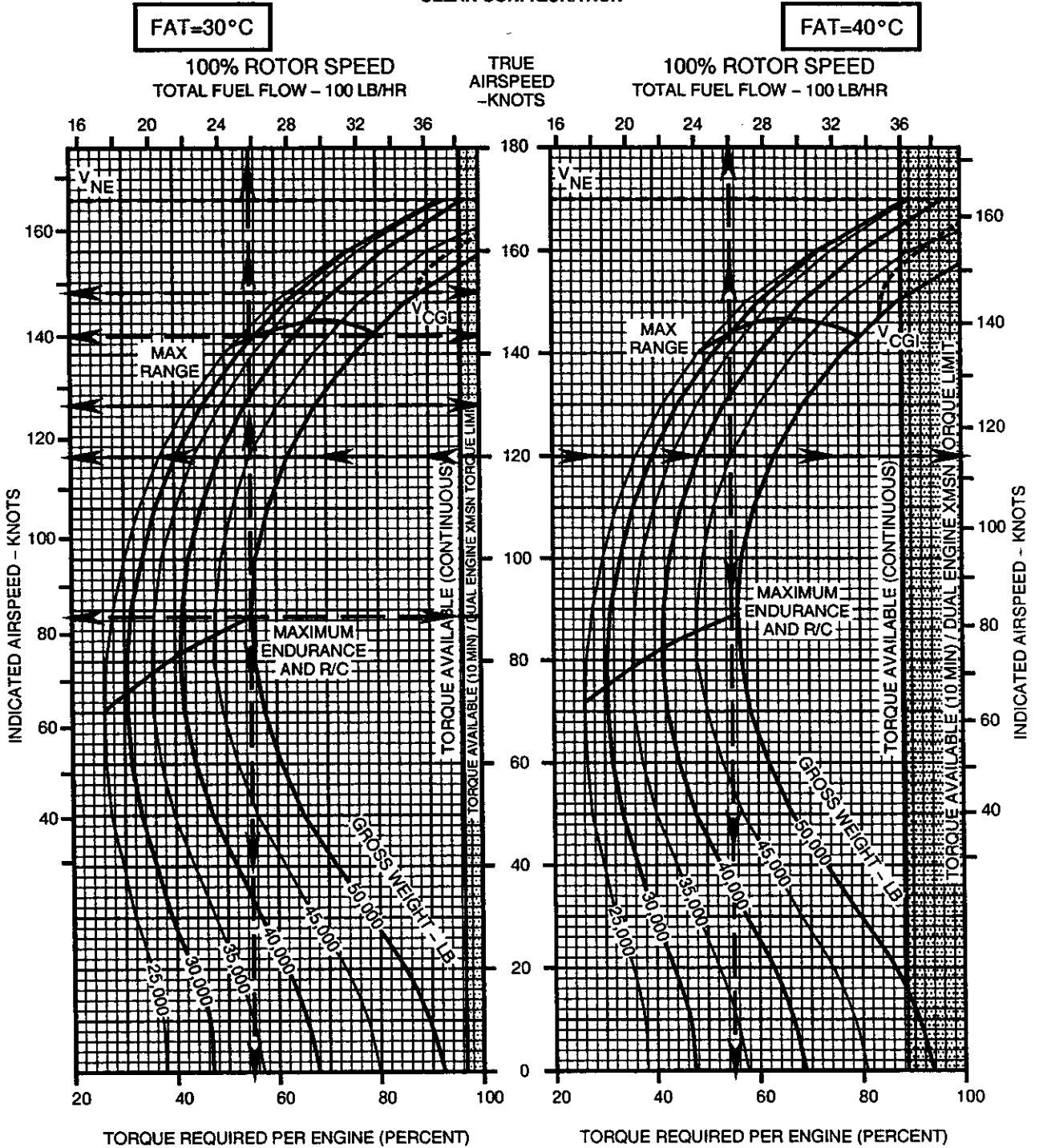
<b>PRESSURE ALTITUDE</b>	<b>SEA LEVEL</b>	<b>SEA LEVEL</b>	<b>SEA LEVEL</b>
FAT	30°C	40°C	35°C
TORQUE REQUIRED (%)	54.7%	55%	54.9%
FUEL FLOW (LB/H)	2,570	2,600	2,585
IAS (KNOTS)	117	114	115.5

Figure 7A-9. Example Cruise Chart (Sheet 1 of 2)

**CRUISE**  
**PRESSURE ALTITUDE - SEA LEVEL**

**CRUISE**  
**CH-47D**  
**(2) T55-GA-714A**

CLEAN CONFIGURATION



DATA BASIS: FLIGHT TEST

A60124

Figure 7A-9. Example Cruise Chart (Sheet 2 of 2)

**CRUISE**

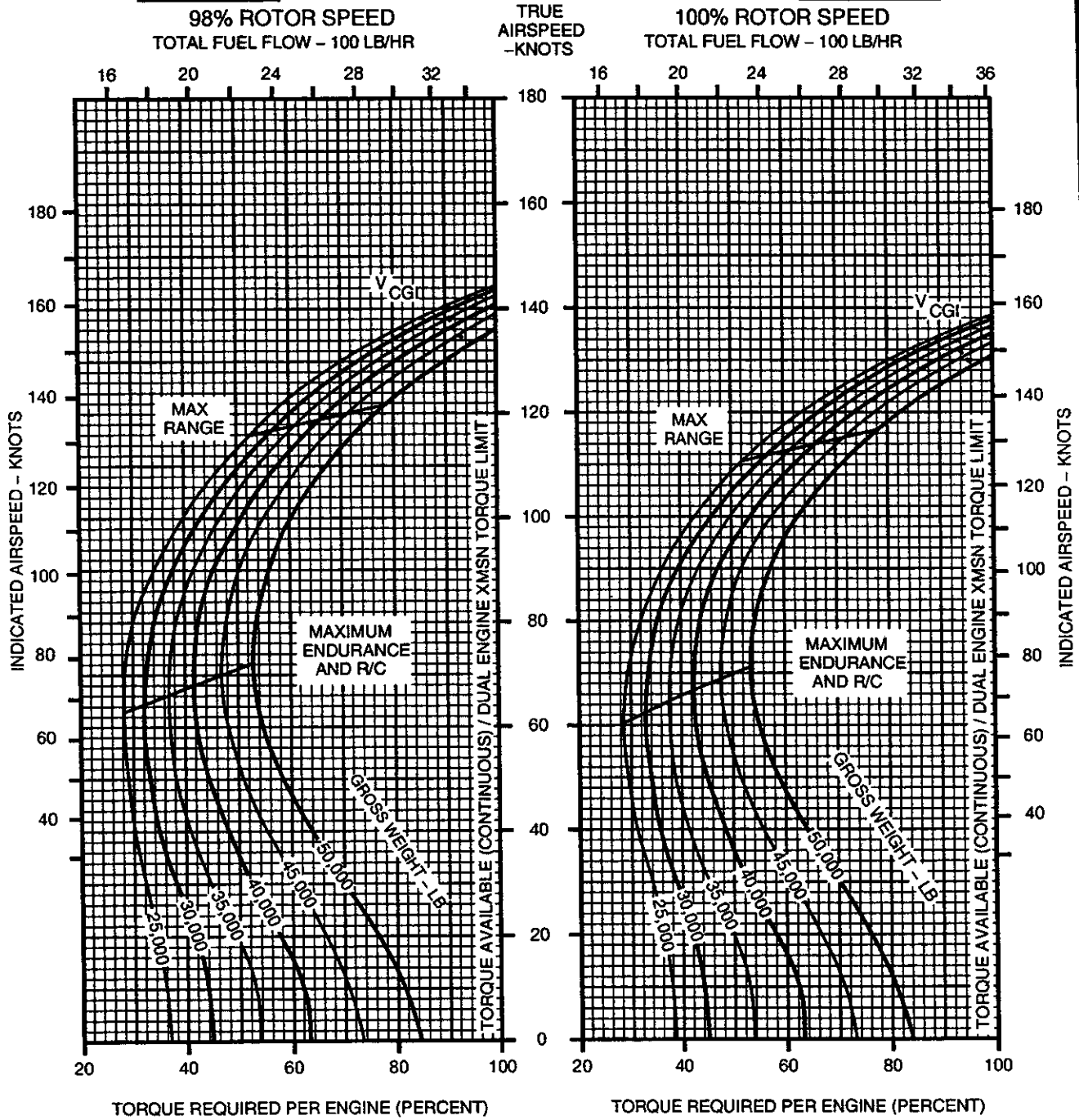
**PRESSURE ALTITUDE - SEA LEVEL**

**CRUISE  
CH-47D  
(2) T55-GA-714A**

**CLEAN CONFIGURATION**

**FAT=-50°C**

**FAT=-50°C**



DATA BASIS: FLIGHT TEST

A60150

**Figure 7A-10. 98 and 100% Rotor RPM, -50°C, Sea Level**

**CRUISE**

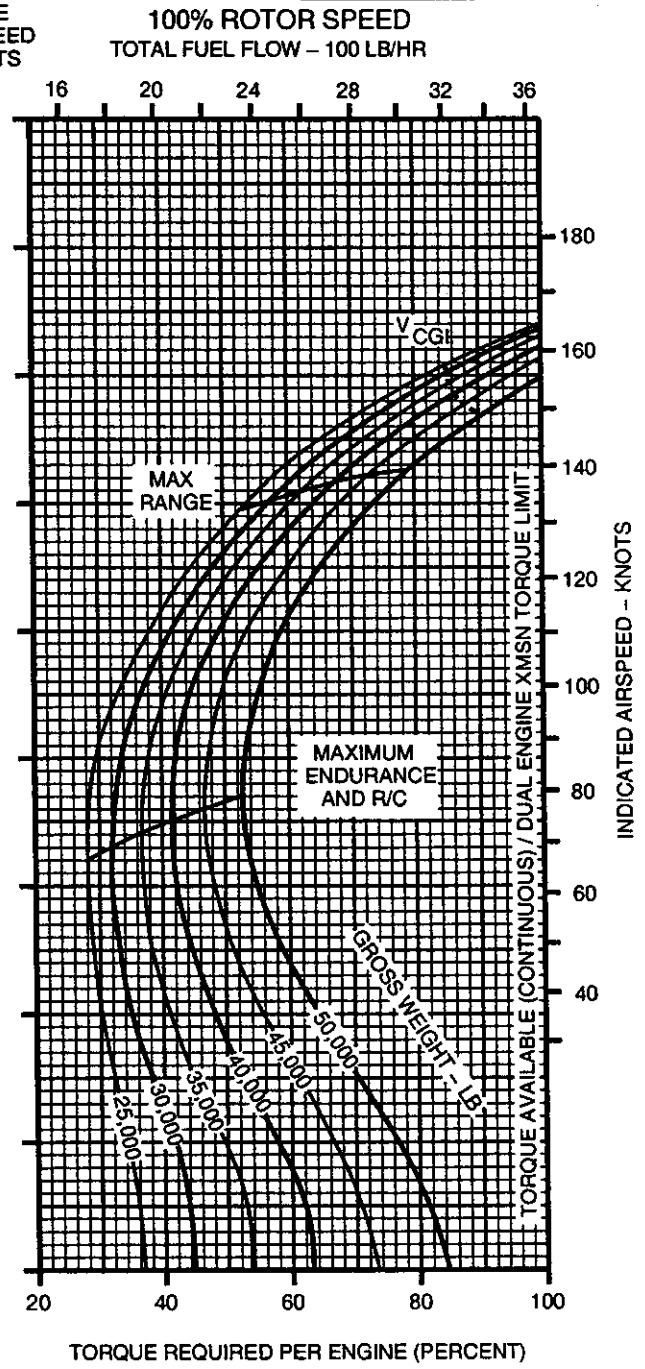
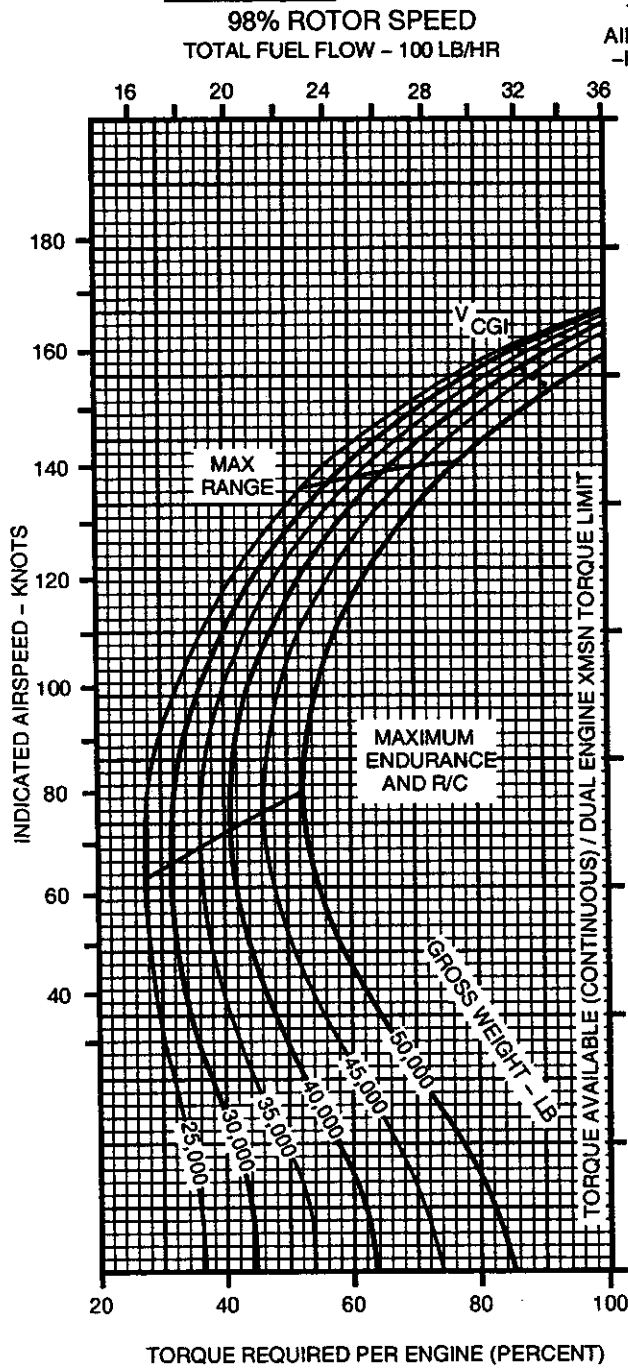
**PRESSURE ALTITUDE - SEA LEVEL**

**CRUISE  
CH-47D  
(2) T55-GA-714A**

**CLEAN CONFIGURATION**

**FAT=-40°C**

**FAT=-40°C**



DATA BASIS: FLIGHT TEST

A60151

**Figure 7A-11. 98 and 100% Rotor RPM, -40°C, Sea Level**

**CRUISE**

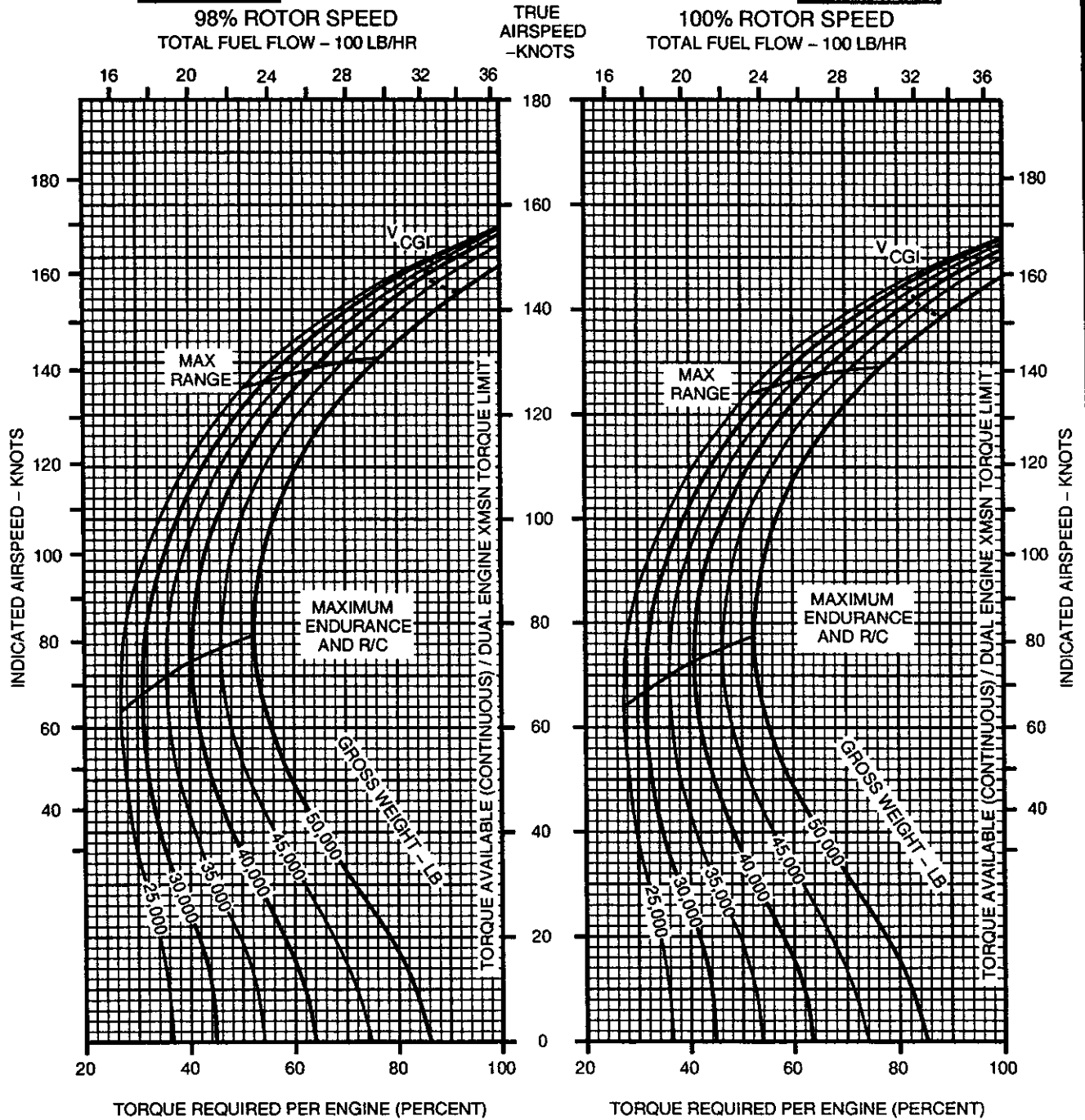
**PRESSURE ALTITUDE - SEA LEVEL**

**CRUISE  
CH-47D  
(2) T55-GA-714A**

**CLEAN CONFIGURATION**

**FAT=-30°C**

**FAT=-30°C**



DATA BASIS: FLIGHT TEST

A60152

**Figure 7A-12. 98 and 100% Rotor RPM, -30°C, Sea Level**

**CRUISE**

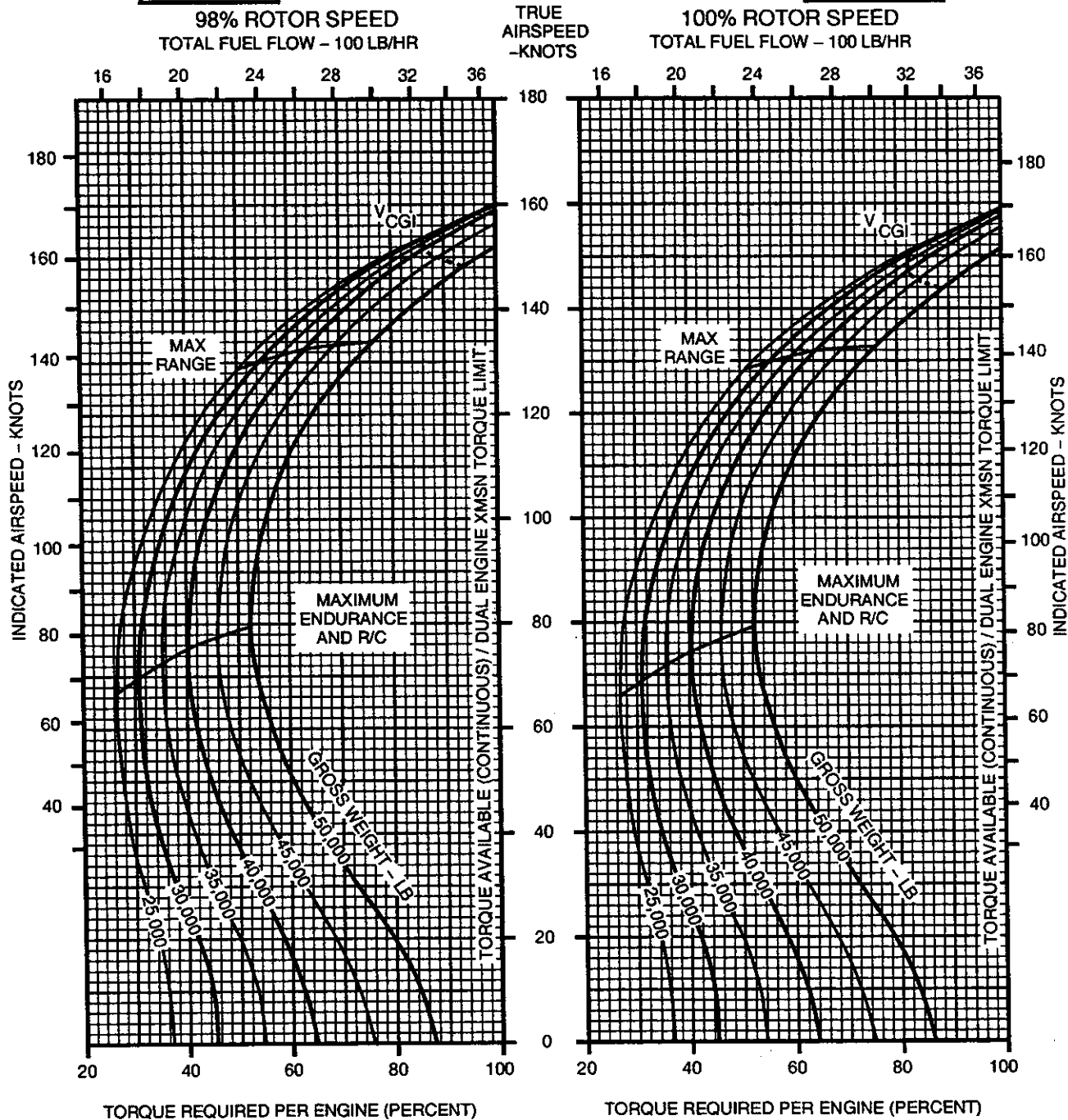
**PRESSURE ALTITUDE - SEA LEVEL**

**CRUISE  
CH-47D  
(2) T55-GA-714A**

**CLEAN CONFIGURATION**

**FAT=-20°C**

**FAT=-20°C**



DATA BASIS: FLIGHT TEST

**Figure 7A-13. 98 and 100% Rotor RPM, -20°C, Sea Level**

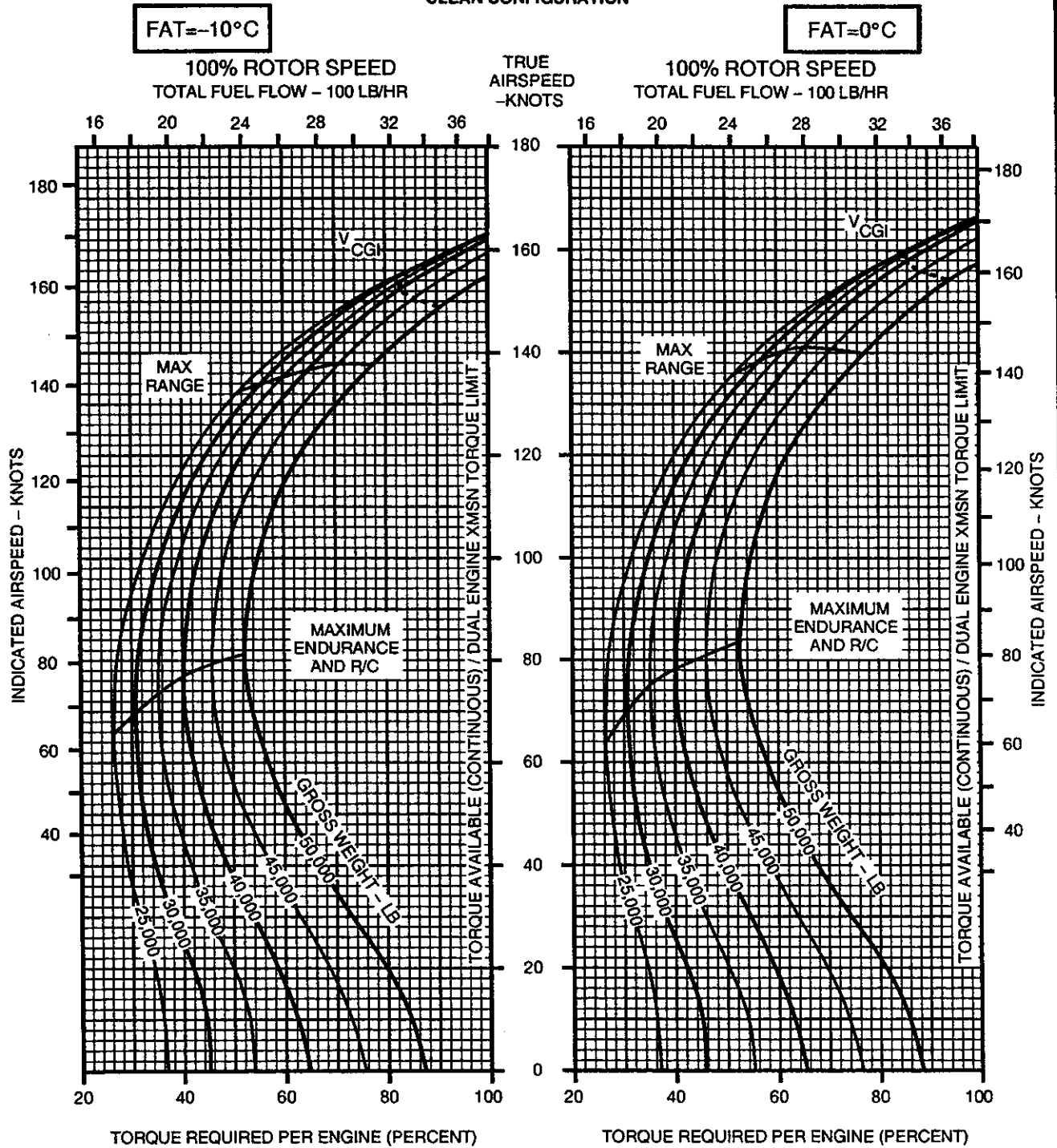
A60153

CRUISE

PRESSURE ALTITUDE - SEA LEVEL

CRUISE  
CH-47D  
(2) T55-GA-714A

CLEAN CONFIGURATION



DATA BASIS: FLIGHT TEST

A60154

Figure 7A-14. 100% Rotor RPM, -10° and 0°C, Sea Level

**CRUISE**

**PRESSURE ALTITUDE - SEA LEVEL**

**CRUISE  
CH-47D  
(2) T55-GA-714A**

**CLEAN CONFIGURATION**

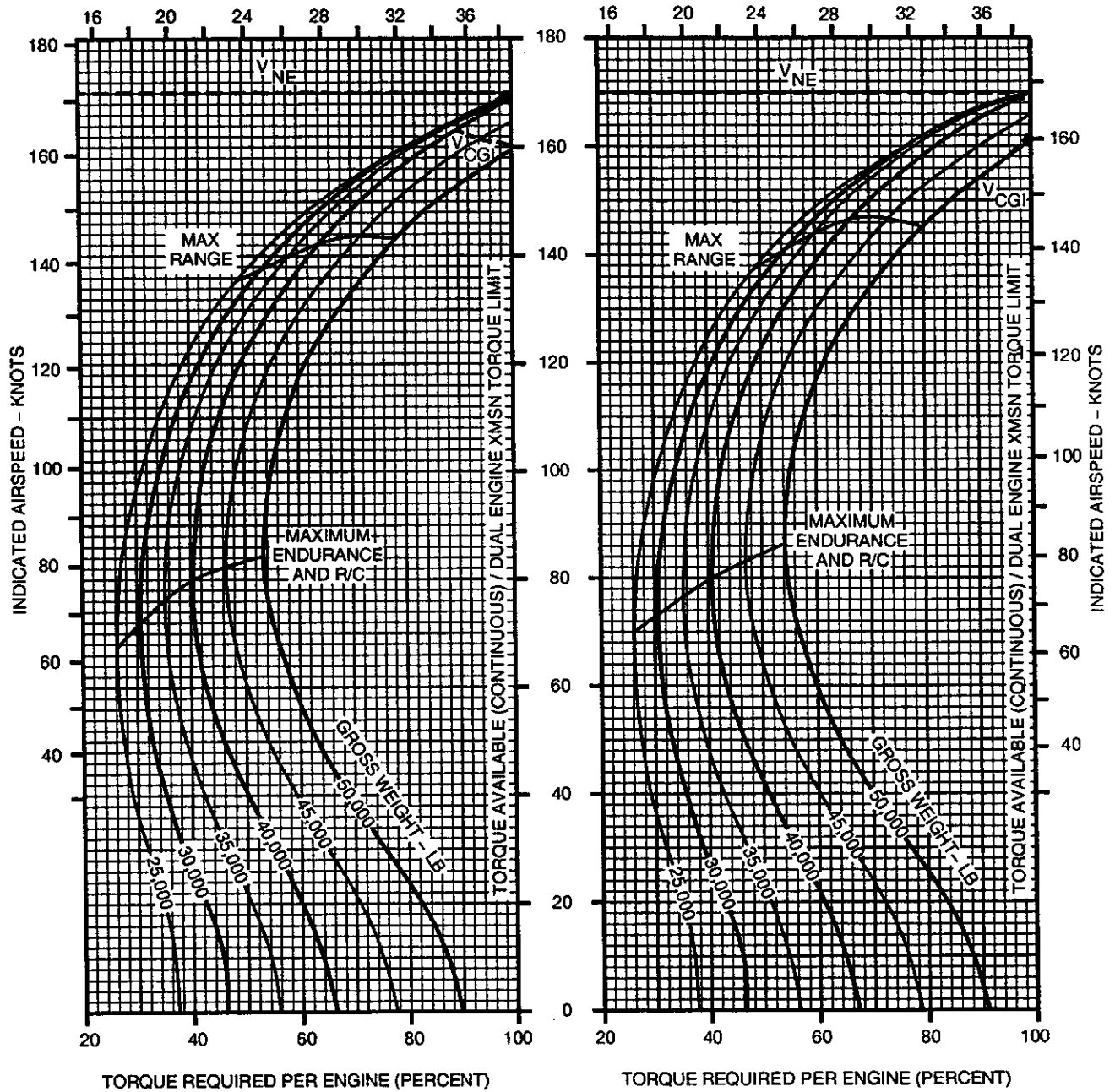
**FAT=10°C**

**FAT=20°C**

**100% ROTOR SPEED  
TOTAL FUEL FLOW - 100 LB/HR**

**TRUE  
AIRSPEED  
-KNOTS**

**100% ROTOR SPEED  
TOTAL FUEL FLOW - 100 LB/HR**



DATA BASIS: FLIGHT TEST

**Figure 7A-15. 100% Rotor RPM, 10° and 20° C, Sea Level**

A60155



**CRUISE**

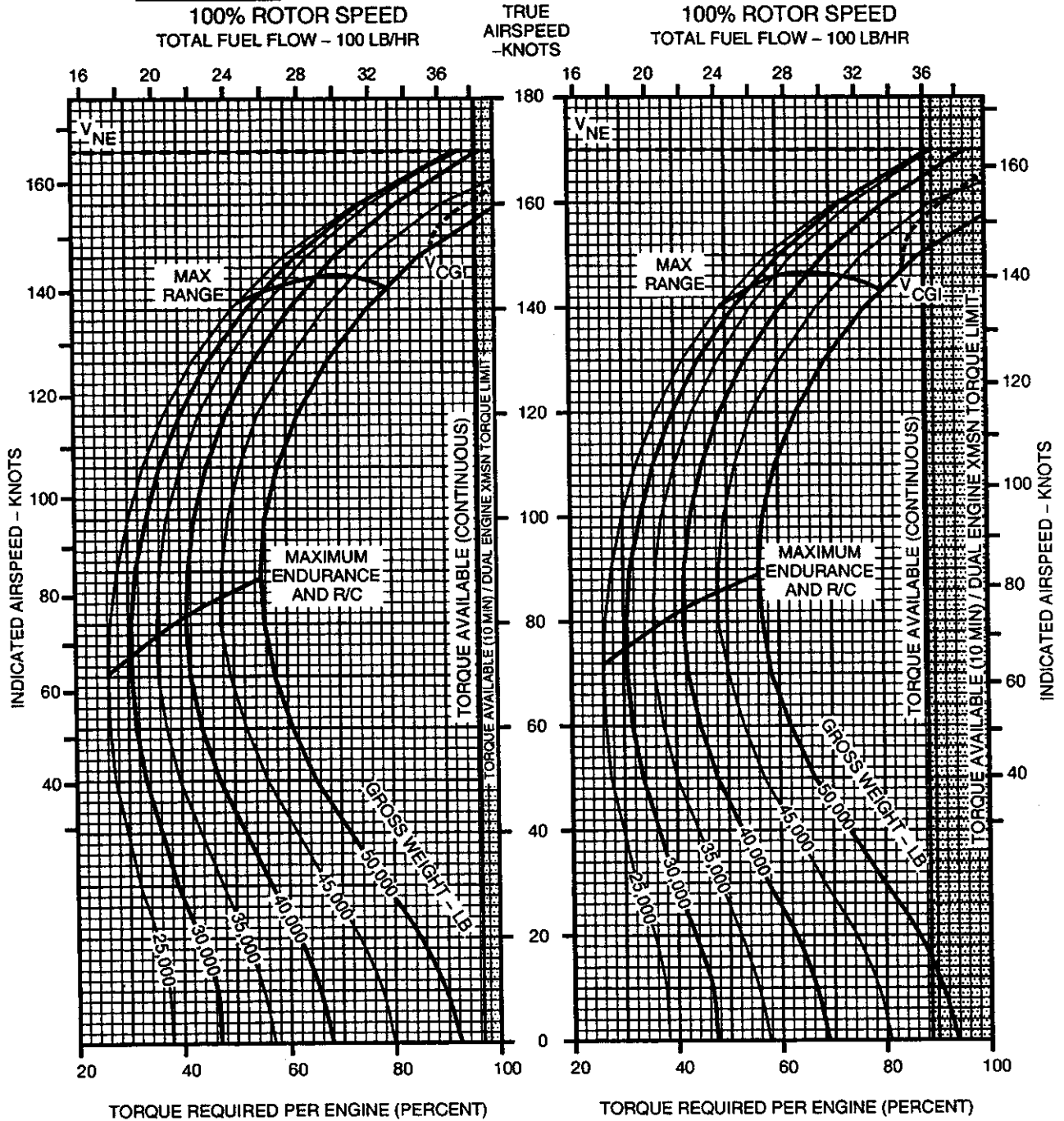
**PRESSURE ALTITUDE - SEA LEVEL**

**CRUISE  
CH-47D  
(2) T55-GA-714A**

**CLEAN CONFIGURATION**

**FAT=30°C**

**FAT=40°C**



DATA BASIS: FLIGHT TEST

A60156

**Figure 7A-16. 100% Rotor RPM, 30° and 40° C, Sea Level**

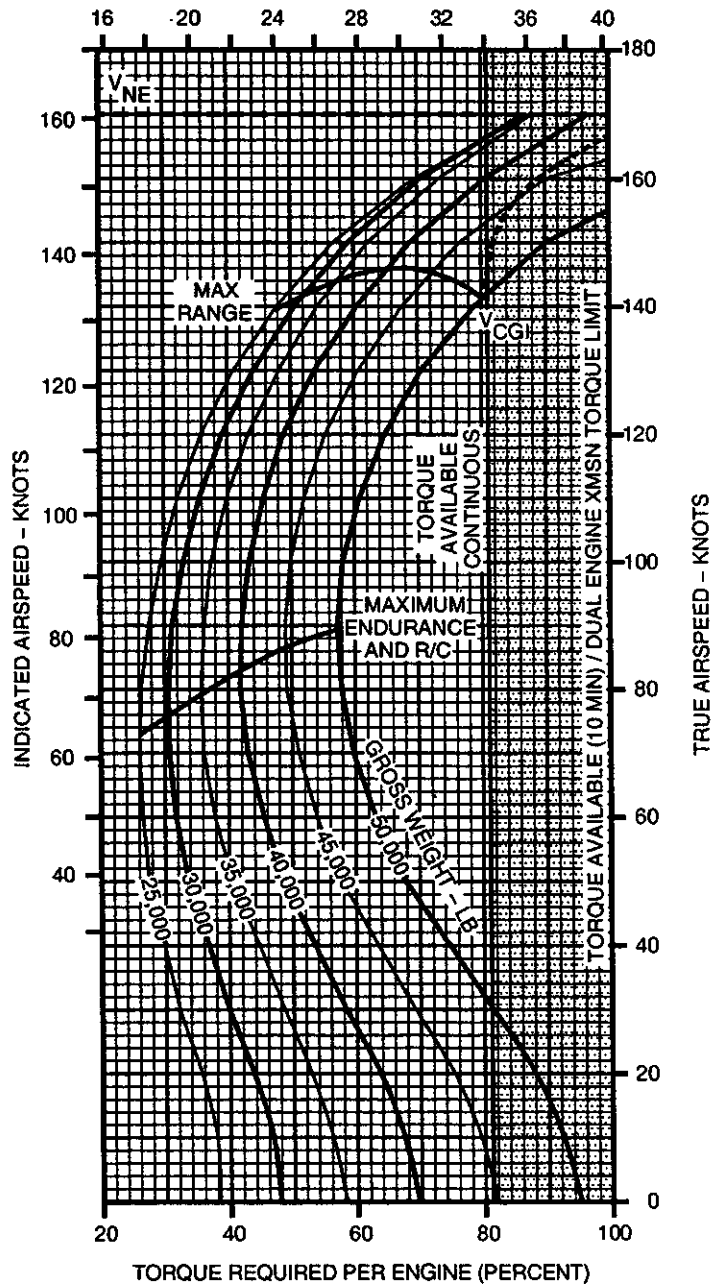
**CRUISE**  
**PRESSURE ALTITUDE - SEA LEVEL**

**CRUISE**  
**CH-47D**  
**(2) T55-GA-714A**

**CLEAN CONFIGURATION**

**FAT=50°C**

**100% ROTOR SPEED**  
**TOTAL FUEL FLOW - 100 LB/HR**



DATA BASIS: FLIGHT TEST

A60157

Figure 7A-17. 100% Rotor RPM, 50°C, Sea Level

**CRUISE**

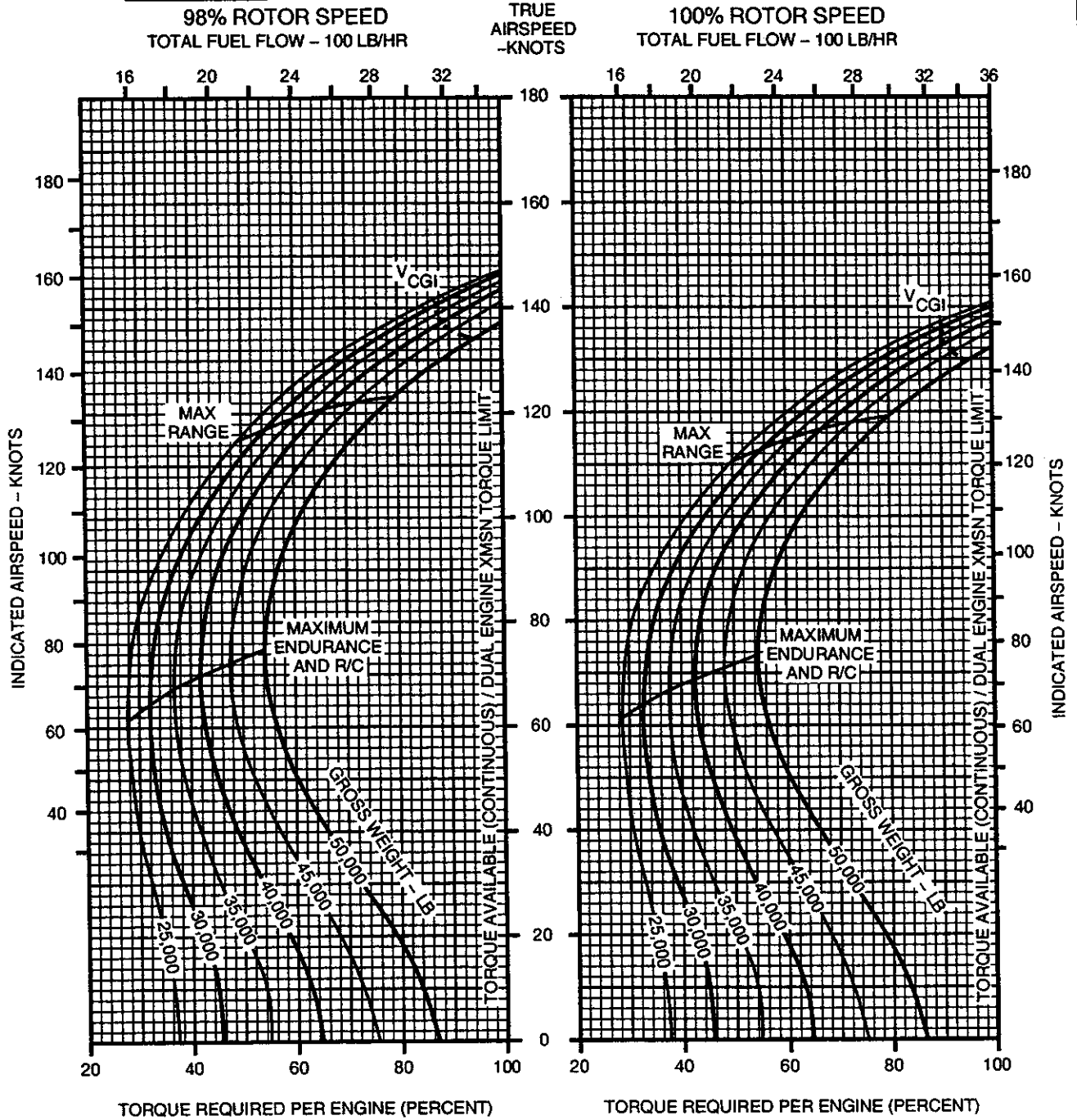
**PRESSURE ALTITUDE - 2000 FT**

**CRUISE  
CH-47D  
(2) T55-GA-714A**

**CLEAN CONFIGURATION**

**FAT=-50°C**

**FAT=-50°C**



DATA BASIS: FLIGHT TEST

A60158

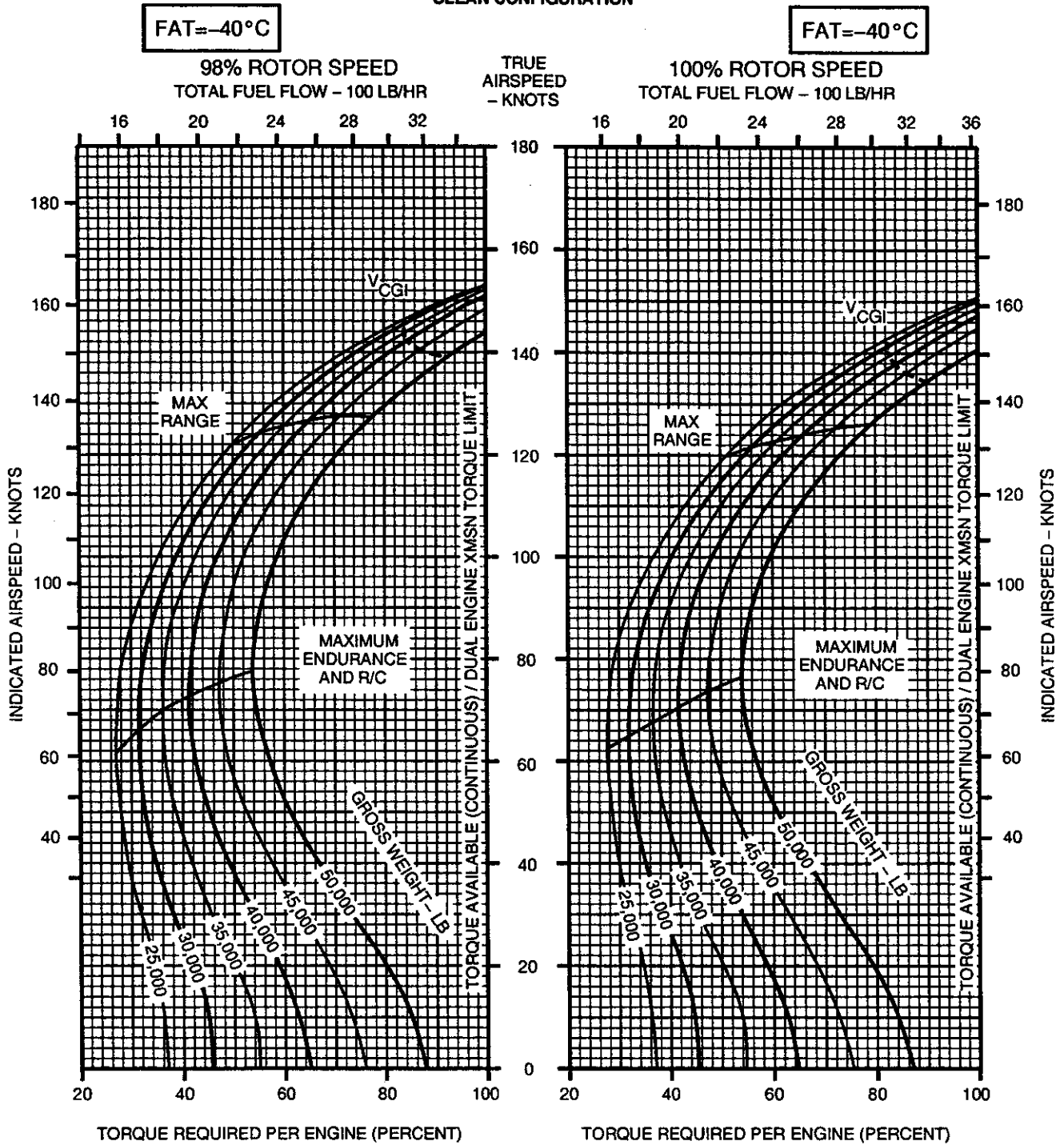
Figure 7A-18. 98 and 100% Rotor RPM, -50°C, 2,000 Feet

**CRUISE**

**PRESSURE ALTITUDE - 2000 FT**

**CRUISE  
CH-47D  
(2) T55-GA-714A**

**CLEAN CONFIGURATION**



DATA BASIS: FLIGHT TEST

A60159

**Figure 7A-19. 98 and 100% Rotor RPM, -40°C, 2,000 Feet**

**CRUISE**

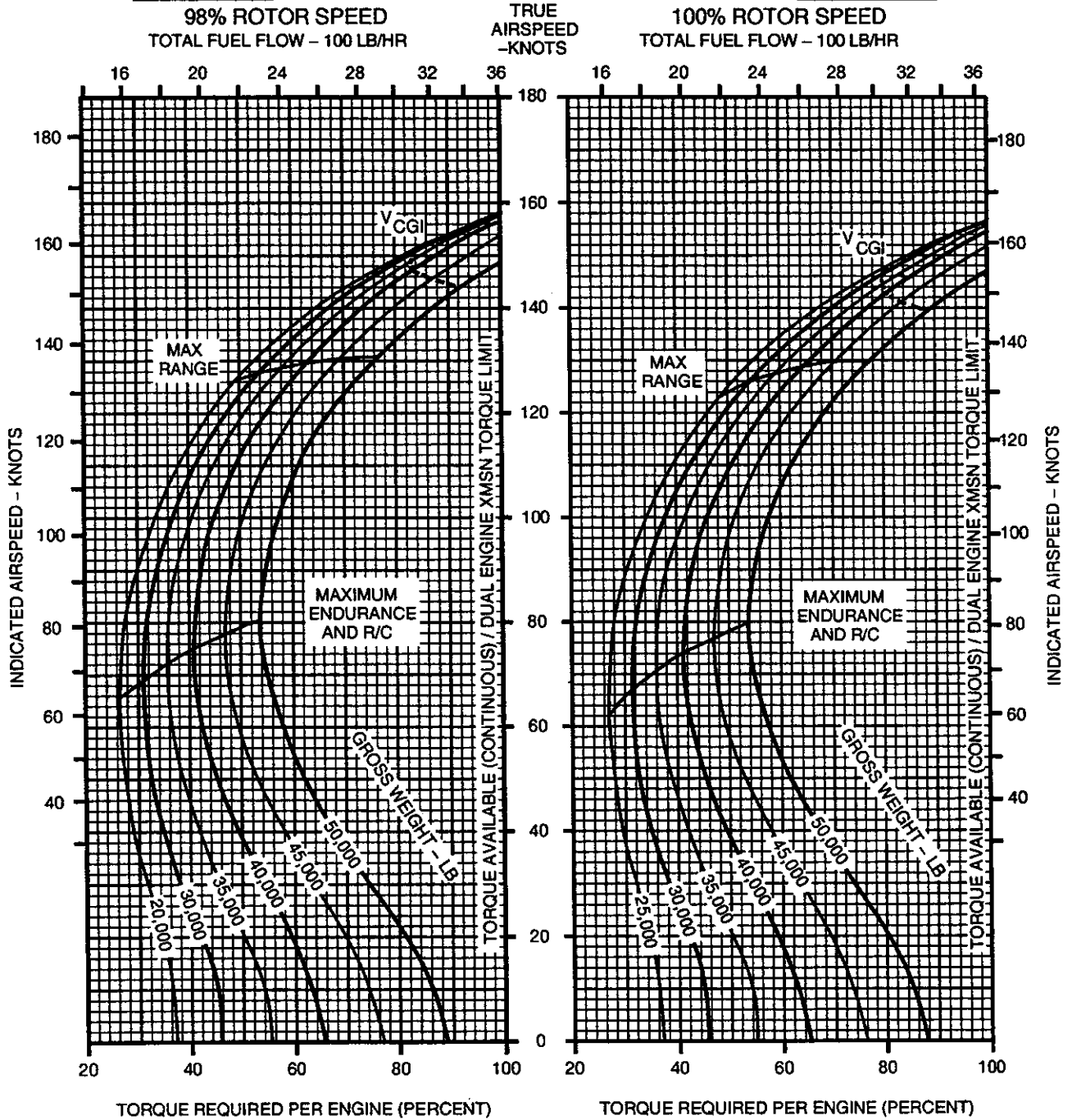
**PRESSURE ALTITUDE - 2000 FT**

**CRUISE  
CH-47D  
(2) T55-GA-714A**

**CLEAN CONFIGURATION**

**FAT=-30°C**

**FAT=-30°C**



DATA BASIS: FLIGHT TEST

A60160

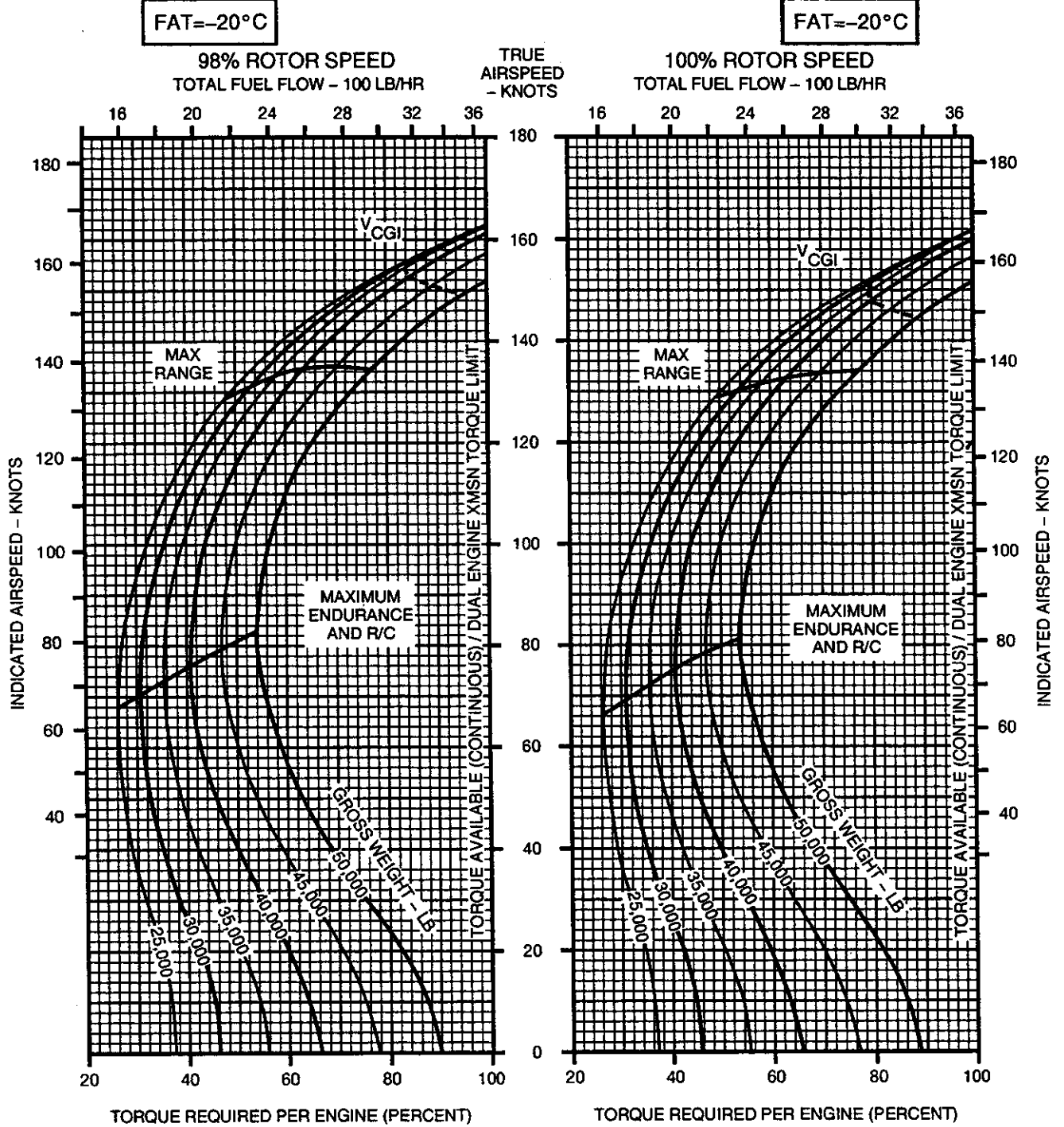
Figure 7A-20. 98 and 100% Rotor RPM, -30°C, 2,000 Feet

**CRUISE**

**PRESSURE ALTITUDE - 2000 FT**

**CRUISE  
CH-47D  
(2) T55-GA-714A**

**CLEAN CONFIGURATION**



DATA BASIS: FLIGHT TEST

**Figure 7A-21. 98 and 100% Rotor RPM, -20°C, 2,000 Feet**

A60161

**CRUISE**

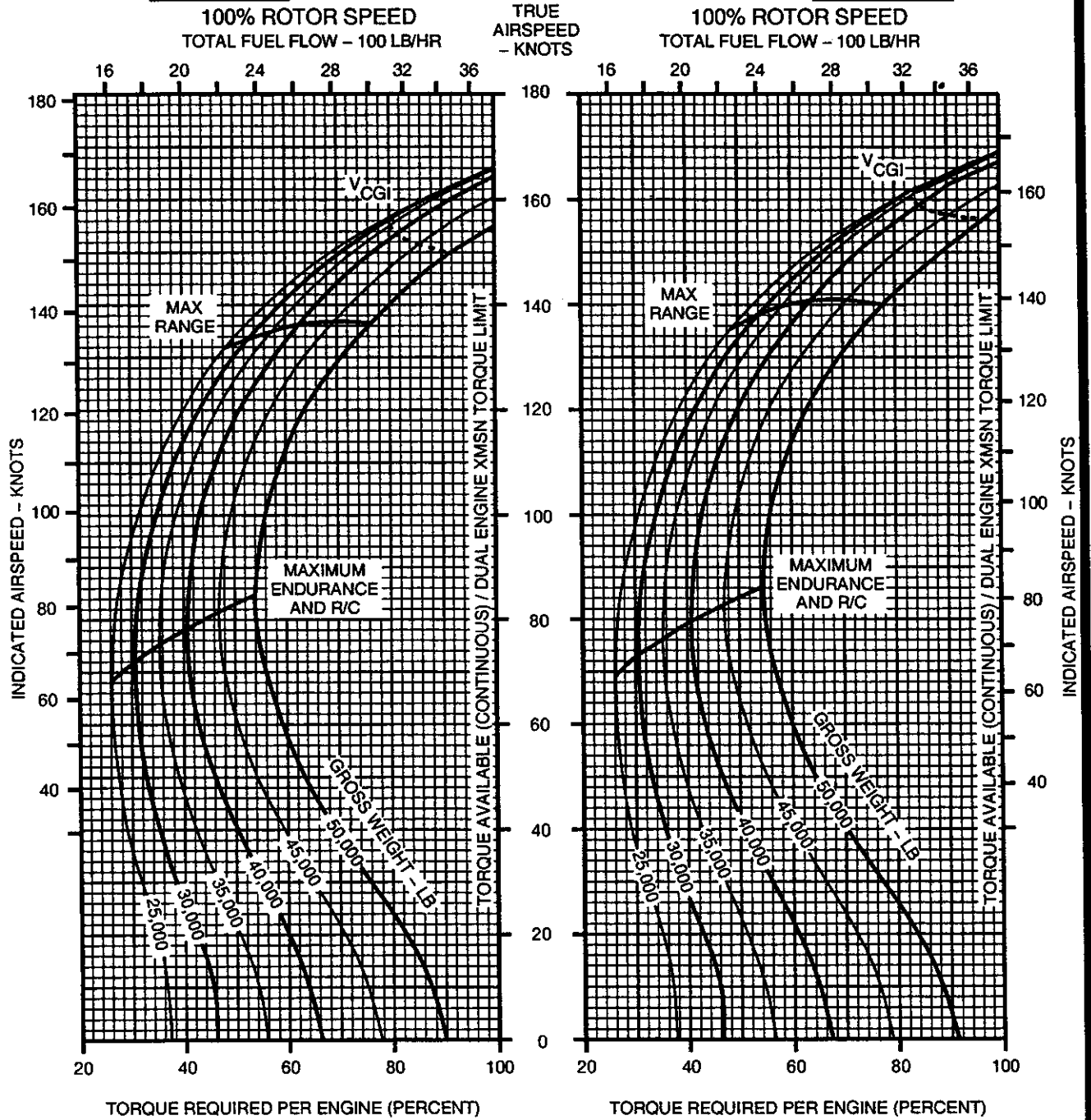
**PRESSURE ALTITUDE - 2000 FT**

**CRUISE  
CH-47D  
(2) T55-GA-714A**

**CLEAN CONFIGURATION**

**FAT=-10°C**

**FAT=0°C**



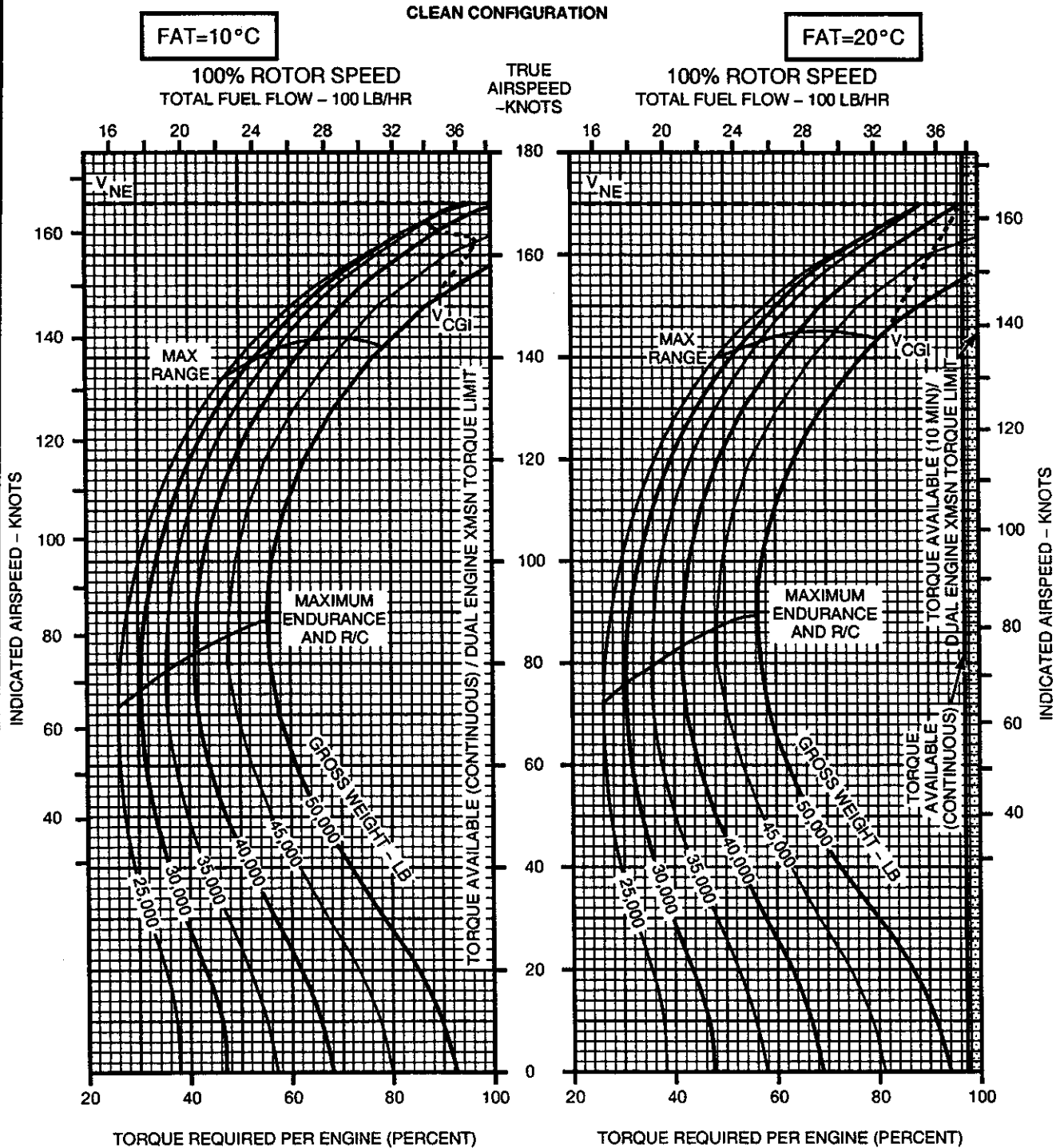
DATA BASIS: FLIGHT TEST

A60162

**Figure 7A-22. 100% Rotor RPM, -10° and 0° C, 2,000 Feet**

**CRUISE**  
**PRESSURE ALTITUDE - 2000 FT**

**CRUISE**  
**CH-47D**  
**(2) T55-GA-714A**



DATA BASIS: FLIGHT TEST

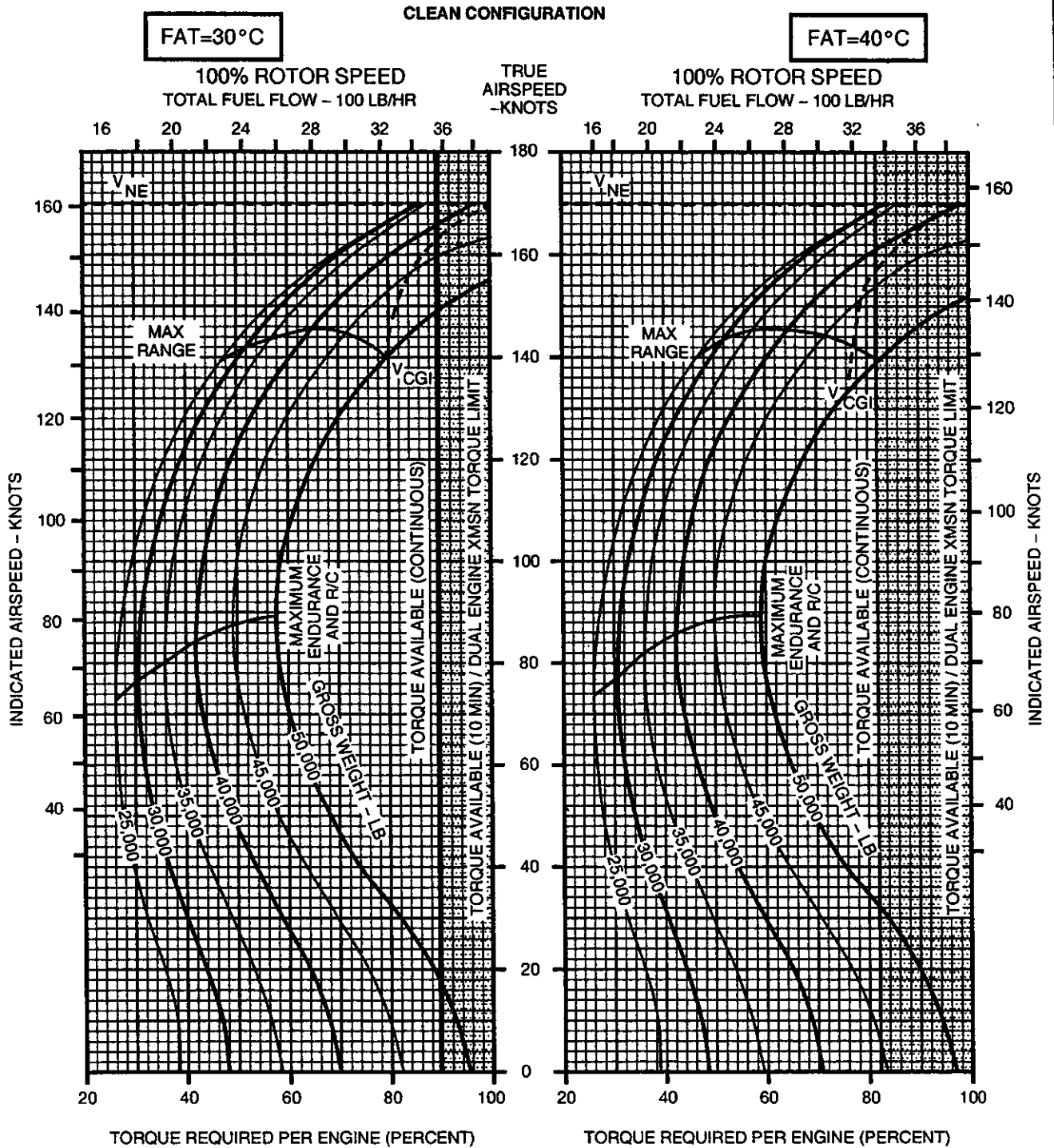
A60163

**Figure 7A-23. 100% Rotor RPM, 10° and 20° C, 2,000 Feet**



**CRUISE**  
**PRESSURE ALTITUDE - 2000 FT**

**CRUISE**  
**CH-47D**  
**(2) T55-GA-714A**



DATA BASIS: FLIGHT TEST

A60164

Figure 7A-24. 100% Rotor RPM, 30° and 40° C, 2,000 Feet

# CRUISE

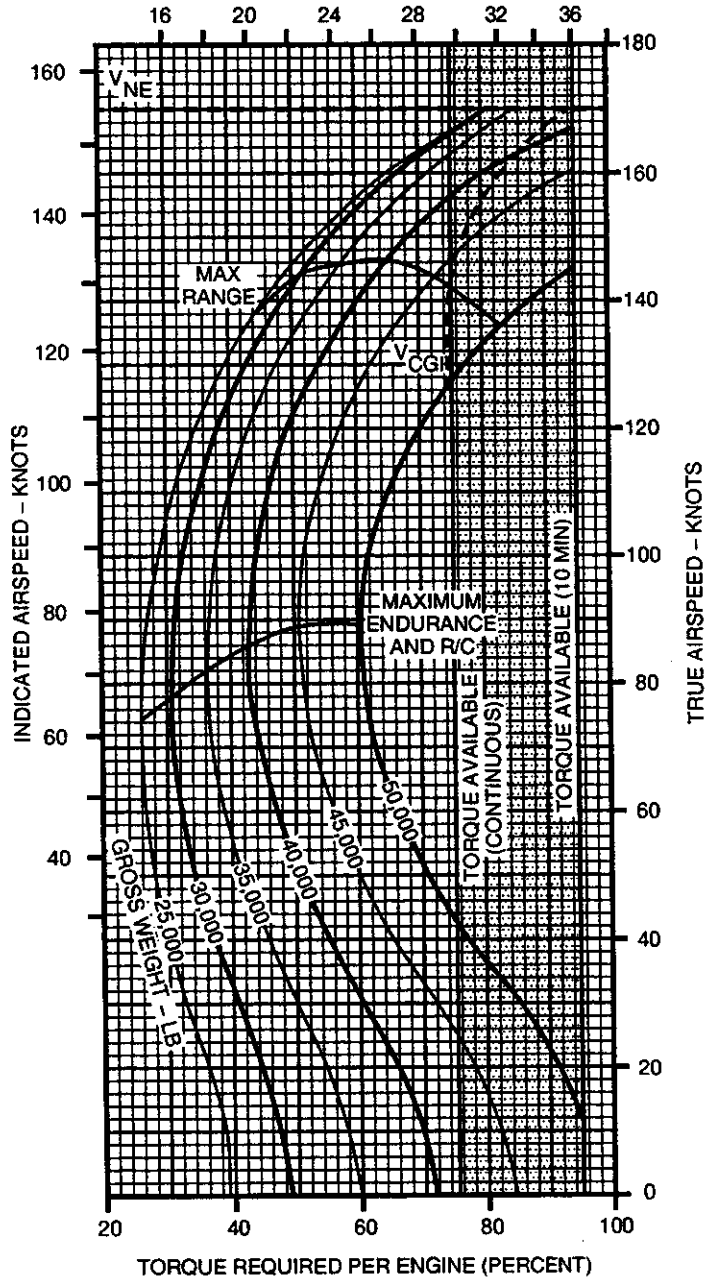
PRESSURE ALTITUDE - 2000 FT

CRUISE  
CH-47D  
(2) T55-GA-714A

CLEAN CONFIGURATION

FAT=50°C

100% ROTOR SPEED  
TOTAL FUEL FLOW - 100 LB/HR



DATA BASIS: FLIGHT TEST

Figure 7A-25. 100% Rotor RPM, 50°C, 2,000 Feet

A60165

**CRUISE**

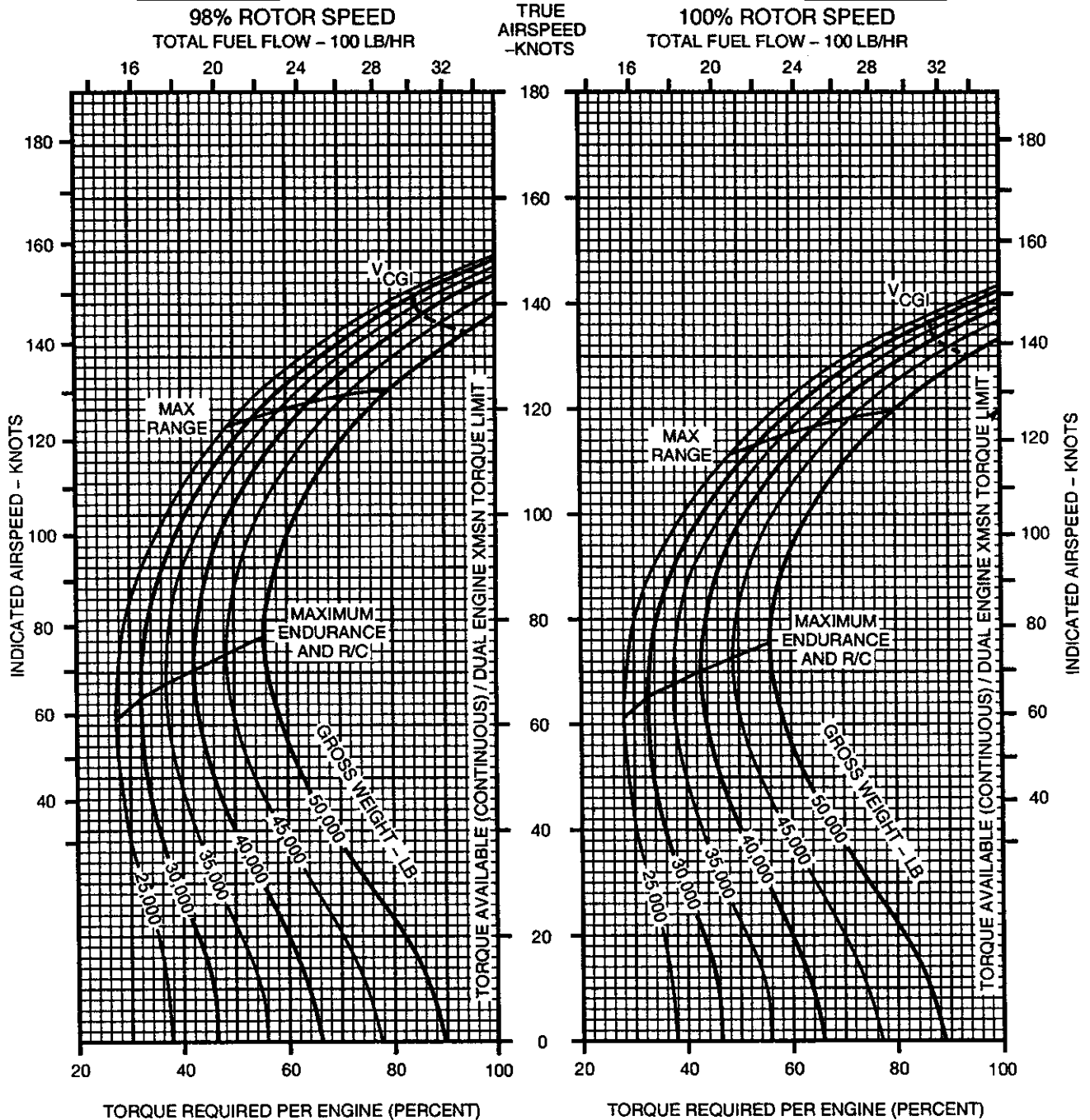
**PRESSURE ALTITUDE - 4000 FT**

**CRUISE  
CH-47D  
(2) T55-GA-714A**

**CLEAN CONFIGURATION**

**FAT=-50°C**

**FAT=-50°C**



DATA BASIS: FLIGHT TEST

A60166

Figure 7A-26. 98 and 100% Rotor RPM, -50°C, 4,000 Feet

**CRUISE**

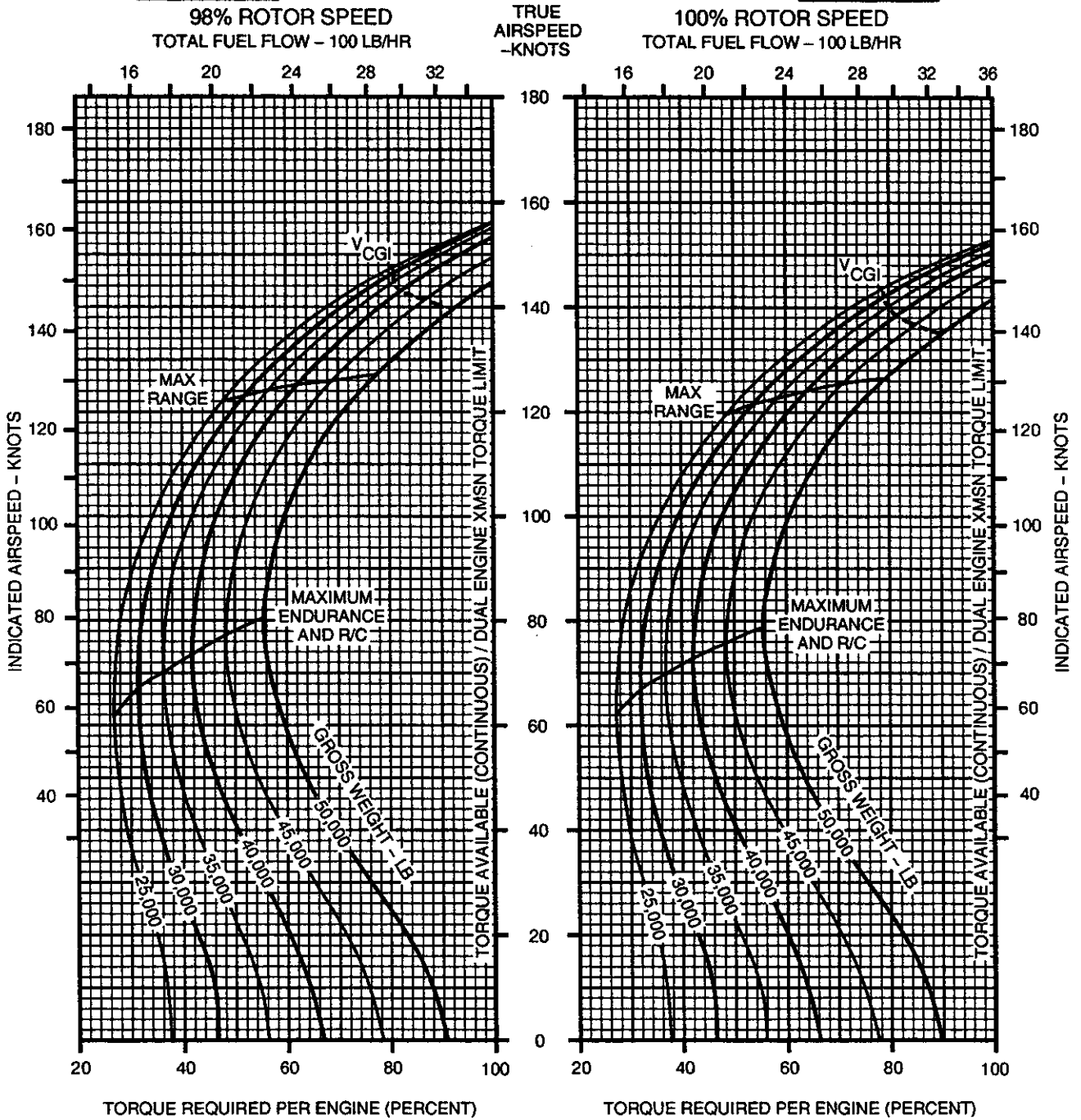
**PRESSURE ALTITUDE - 4000 FT**

**CRUISE  
CH-47D  
(2) T55-GA-714A**

**CLEAN CONFIGURATION**

**FAT = -40°C**

**FAT = -40°C**



DATA BASIS: FLIGHT TEST

**Figure 7A-27. 98 and 100% Rotor RPM, -40°C, 4,000 Feet**

A60167

**CRUISE**

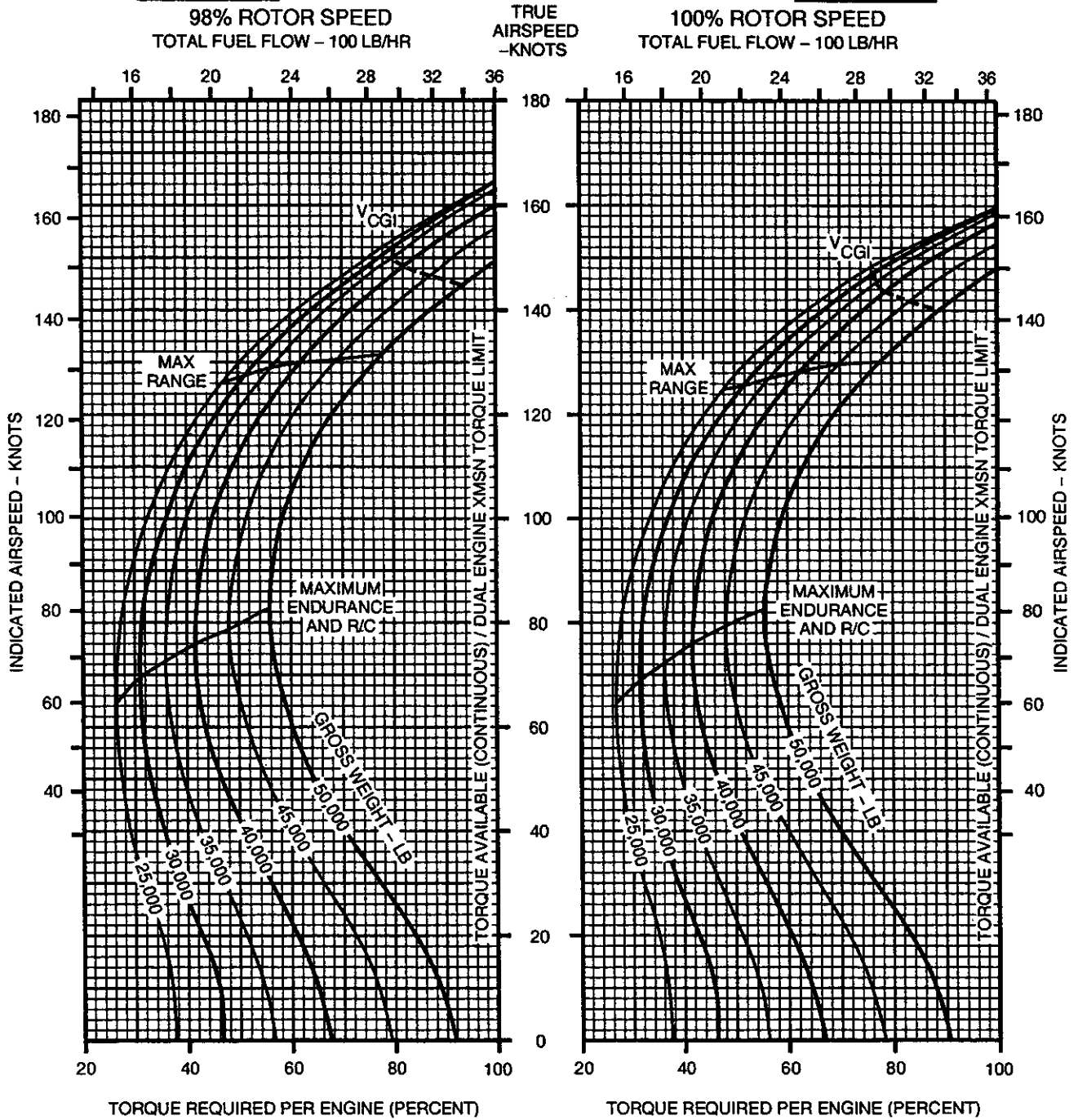
**PRESSURE ALTITUDE - 4000 FT**

**CRUISE  
CH-47D  
(2) T55-GA-714A**

**CLEAN CONFIGURATION**

**FAT = -30°C**

**FAT = -30°C**



DATA BASIS: FLIGHT TEST

A60168

**Figure 7A-28. 98 and 100% Rotor RPM, -30°C, 4,000 Feet**

**CRUISE**

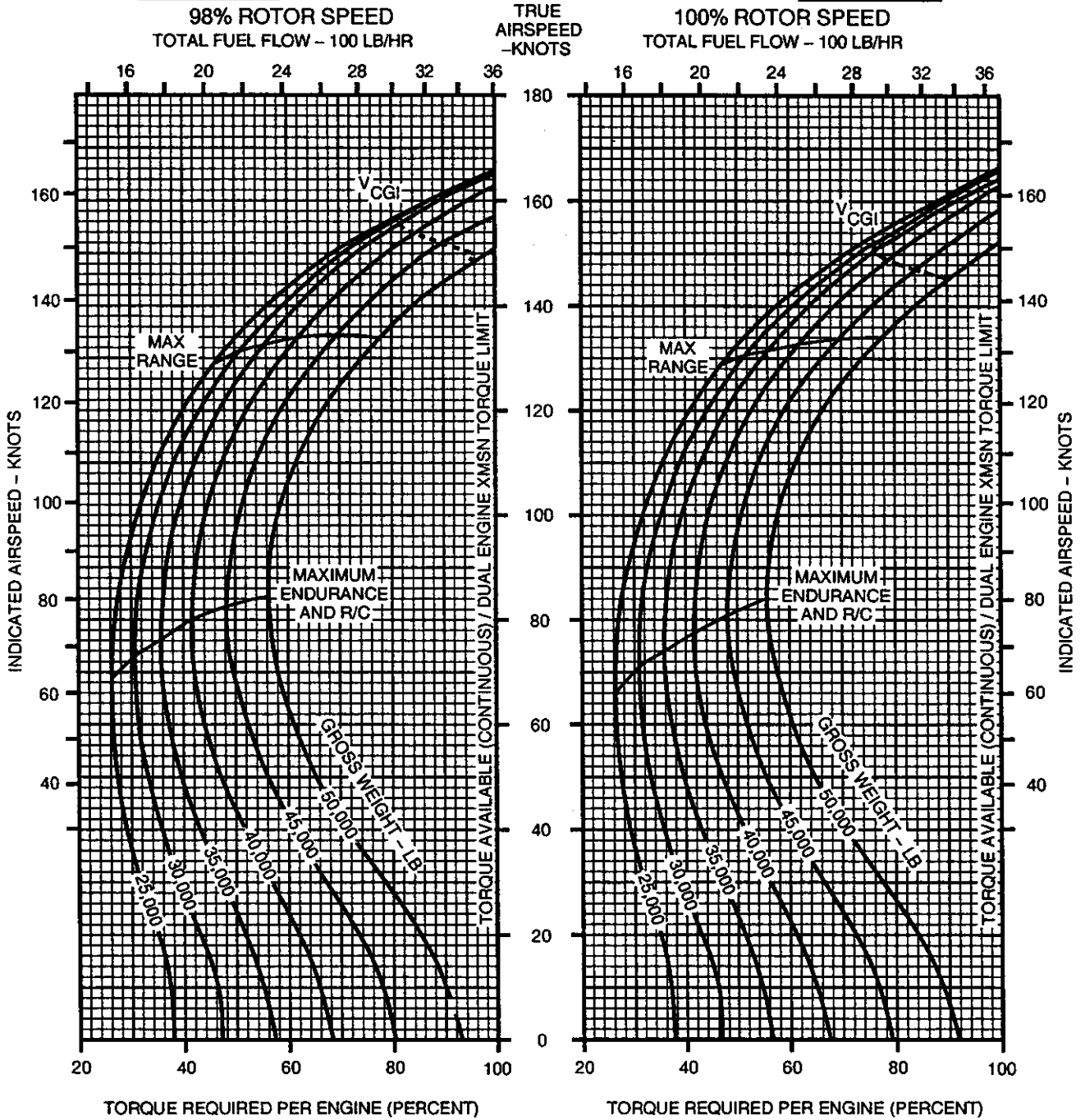
**PRESSURE ALTITUDE - 4000 FT**

**CRUISE  
CH-47D  
(2) T55-GA-714A**

**CLEAN CONFIGURATION**

**FAT=-20°C**

**FAT=-20°C**



DATA BASIS: FLIGHT TEST

**Figure 7A-29. 98 and 100% Rotor RPM, -20°C, 4,000 Feet**

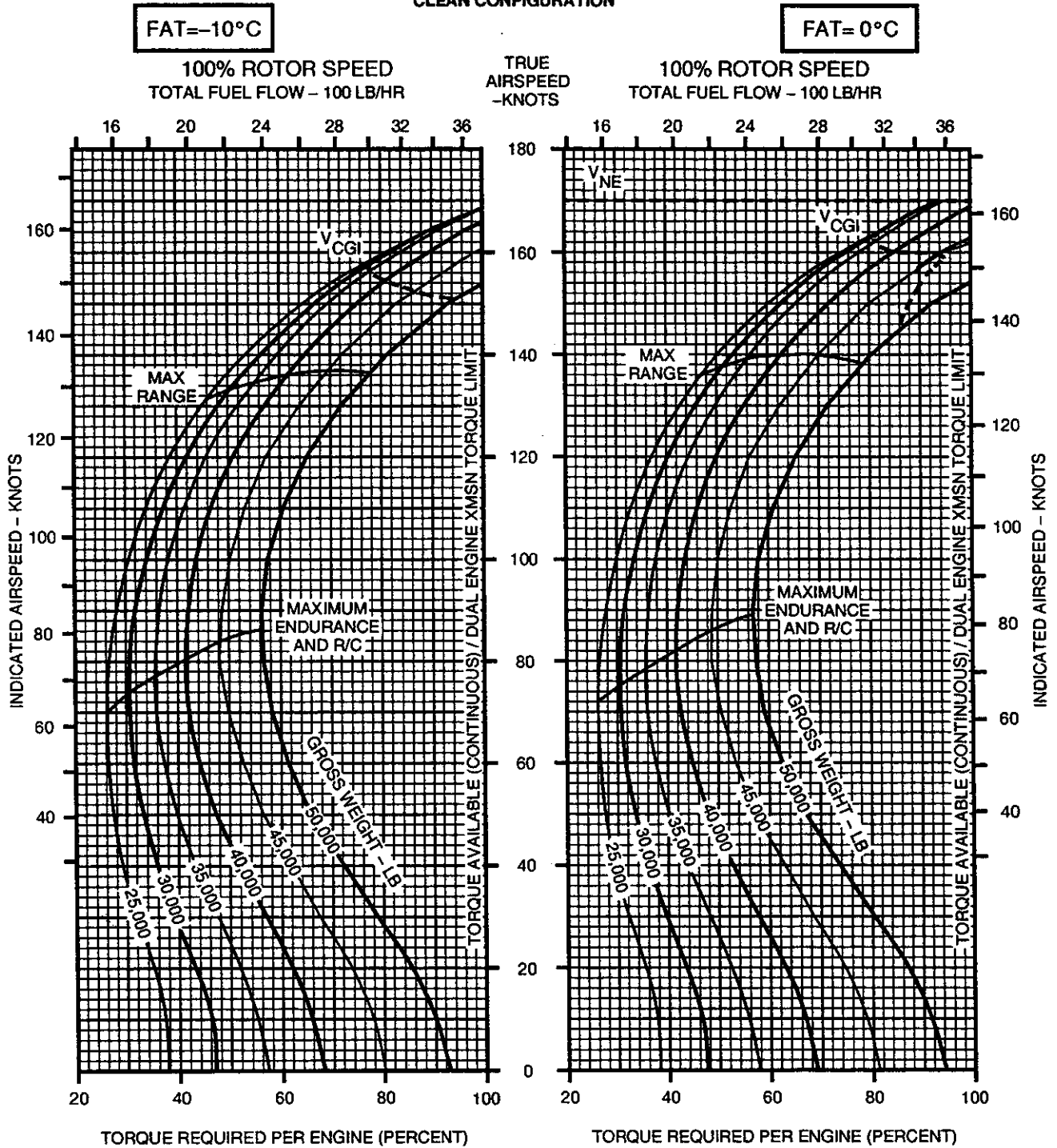
A60169

**CRUISE**

**PRESSURE ALTITUDE - 4000 FT**

**CRUISE  
CH-47D  
(2) T55-GA-714A**

**CLEAN CONFIGURATION**



DATA BASIS: FLIGHT TEST

A60170

Figure 7A-30. 100% Rotor RPM, -10° and 0° C, 4,000 Feet

**CRUISE**

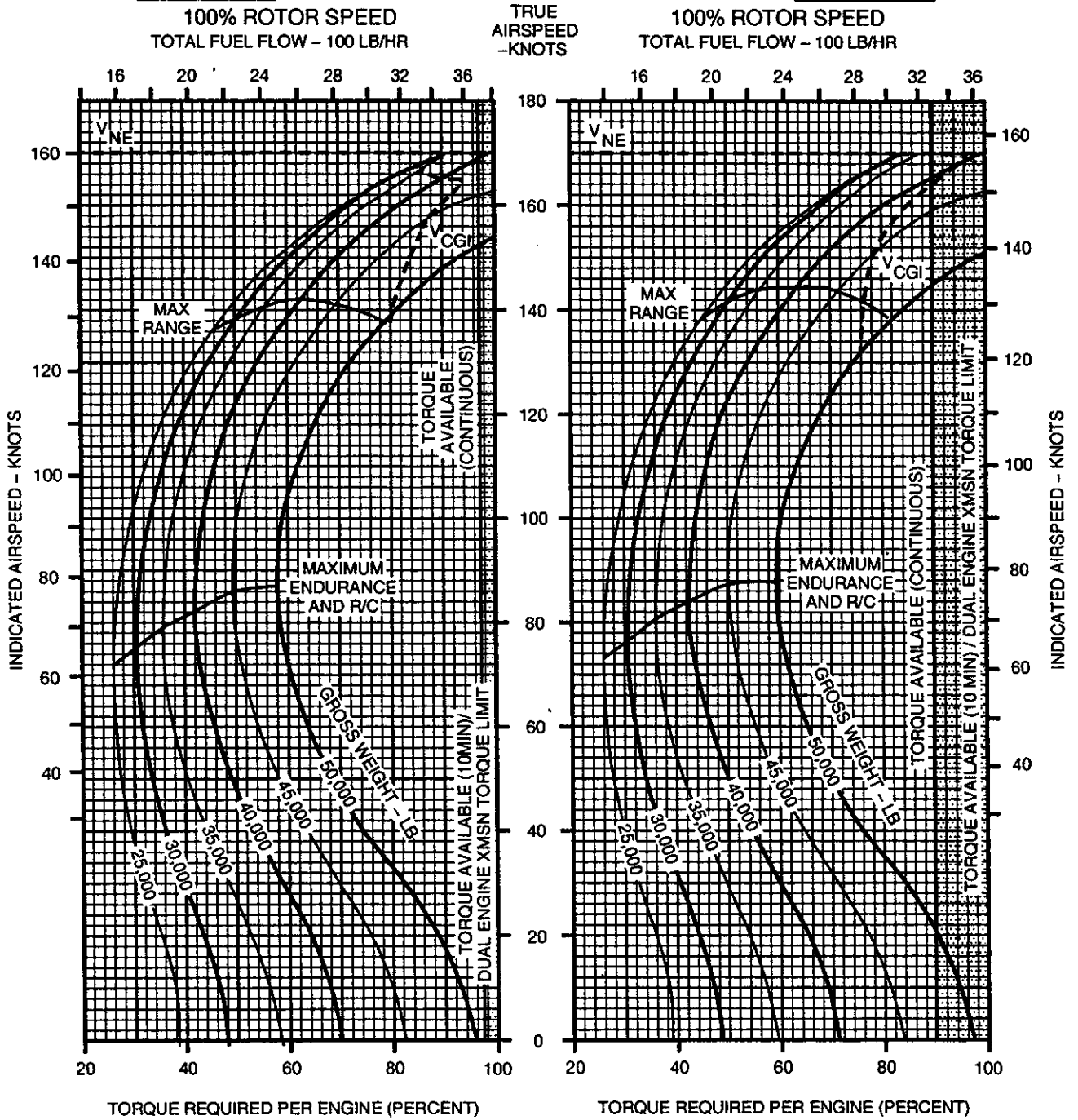
**PRESSURE ALTITUDE - 4000 FT**

**CRUISE  
CH-47D  
(2) T55-GA-714A**

**CLEAN CONFIGURATION**

**FAT = 10 °C**

**FAT = 20 °C**



DATA BASIS: FLIGHT TEST

**Figure 7A-31. 100% Rotor RPM, 10° and 20° C, 4,000 Feet**

A60171



**CRUISE**

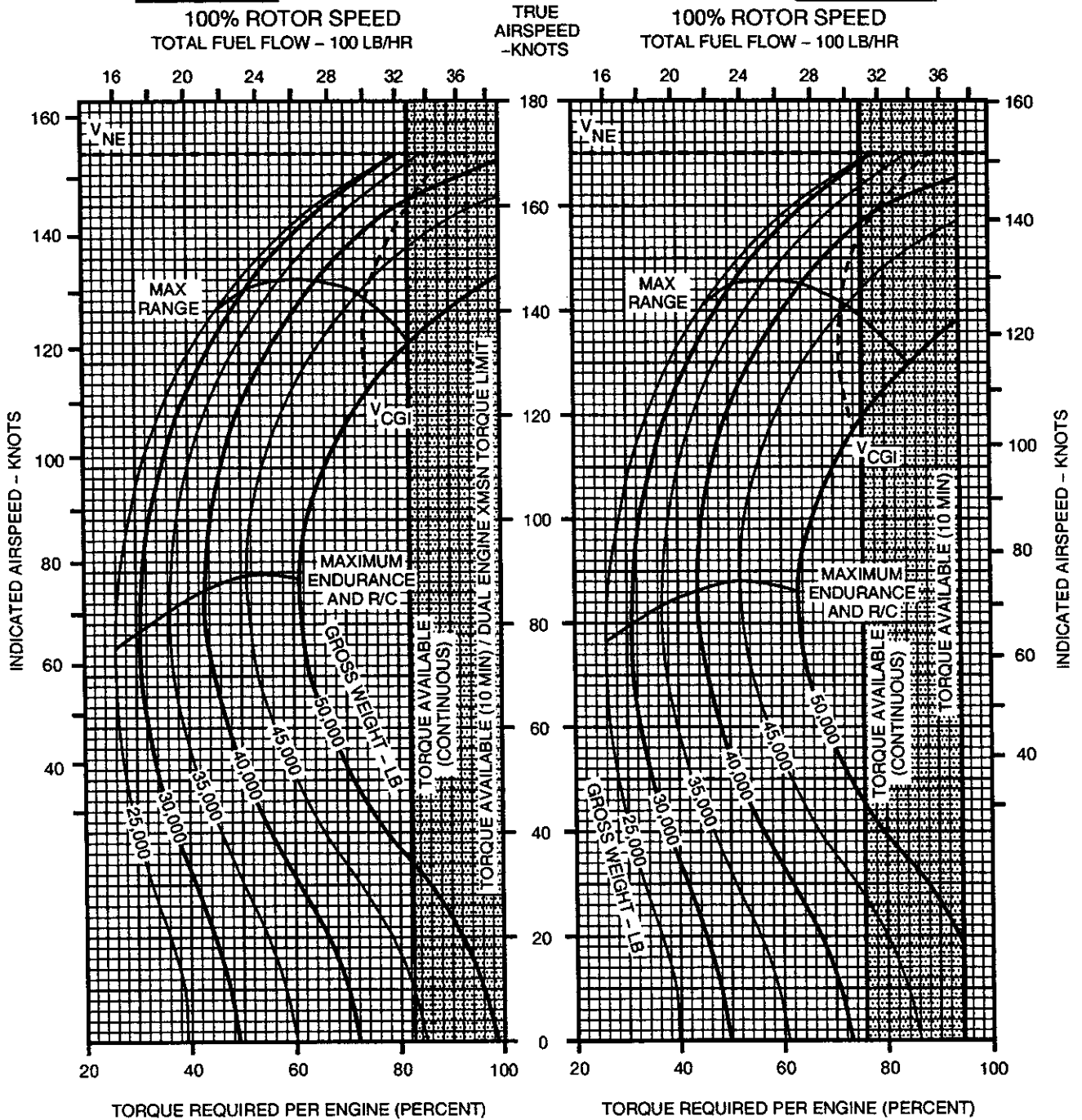
**PRESSURE ALTITUDE - 4000 FT**

**CRUISE  
CH-47D  
(2) T55-GA-714A**

**CLEAN CONFIGURATION**

**FAT = 30°C**

**FAT = 40°C**



DATA BASIS: FLIGHT TEST

A60172

**Figure 7A-32. 100% Rotor RPM, 30° and 40° C, 4,000 Feet**

# CRUISE

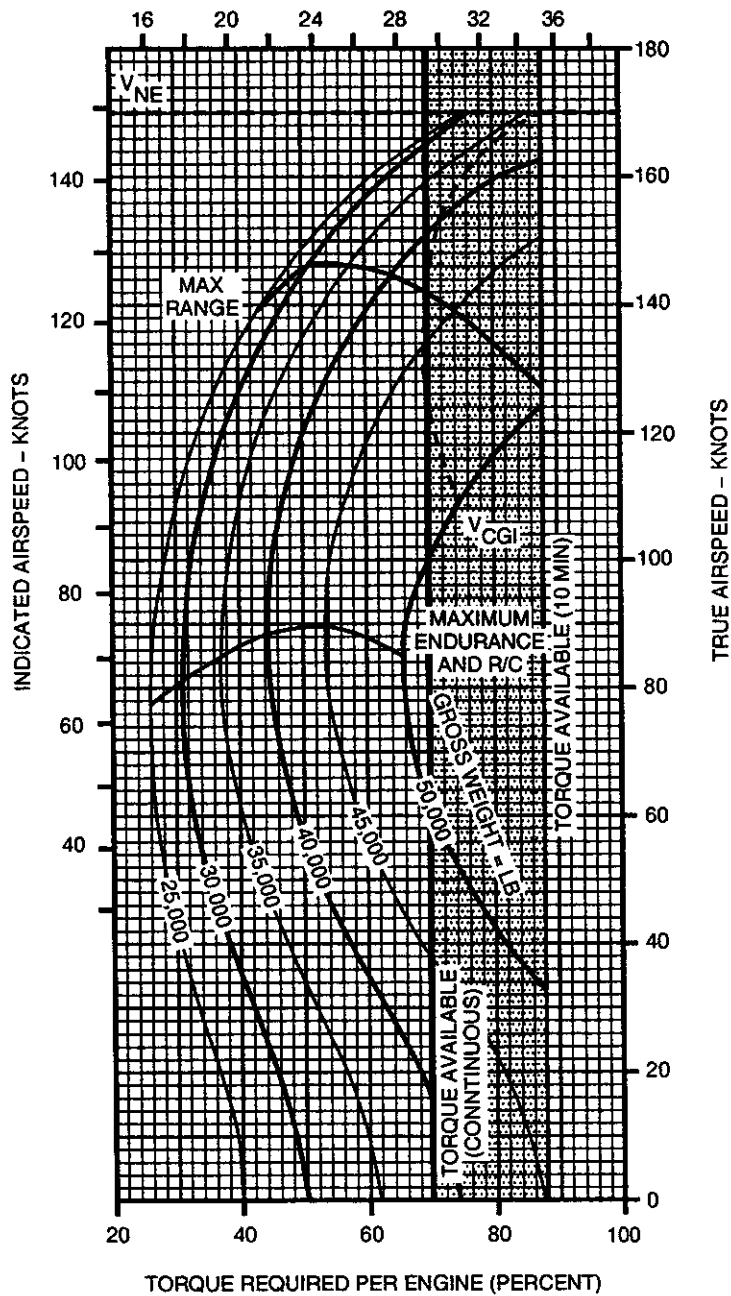
PRESSURE ALTITUDE - 4000 FT

CRUISE  
CH-47D  
(2) T55-GA-714A

CLEAN CONFIGURATION

FAT = 50°C

100% ROTOR SPEED  
TOTAL FUEL FLOW - 100 LB/HR



DATA BASIS: FLIGHT TEST

A60173

Figure 7A-33. 100% Rotor RPM, 50°C, 4,000 Feet

**CRUISE**

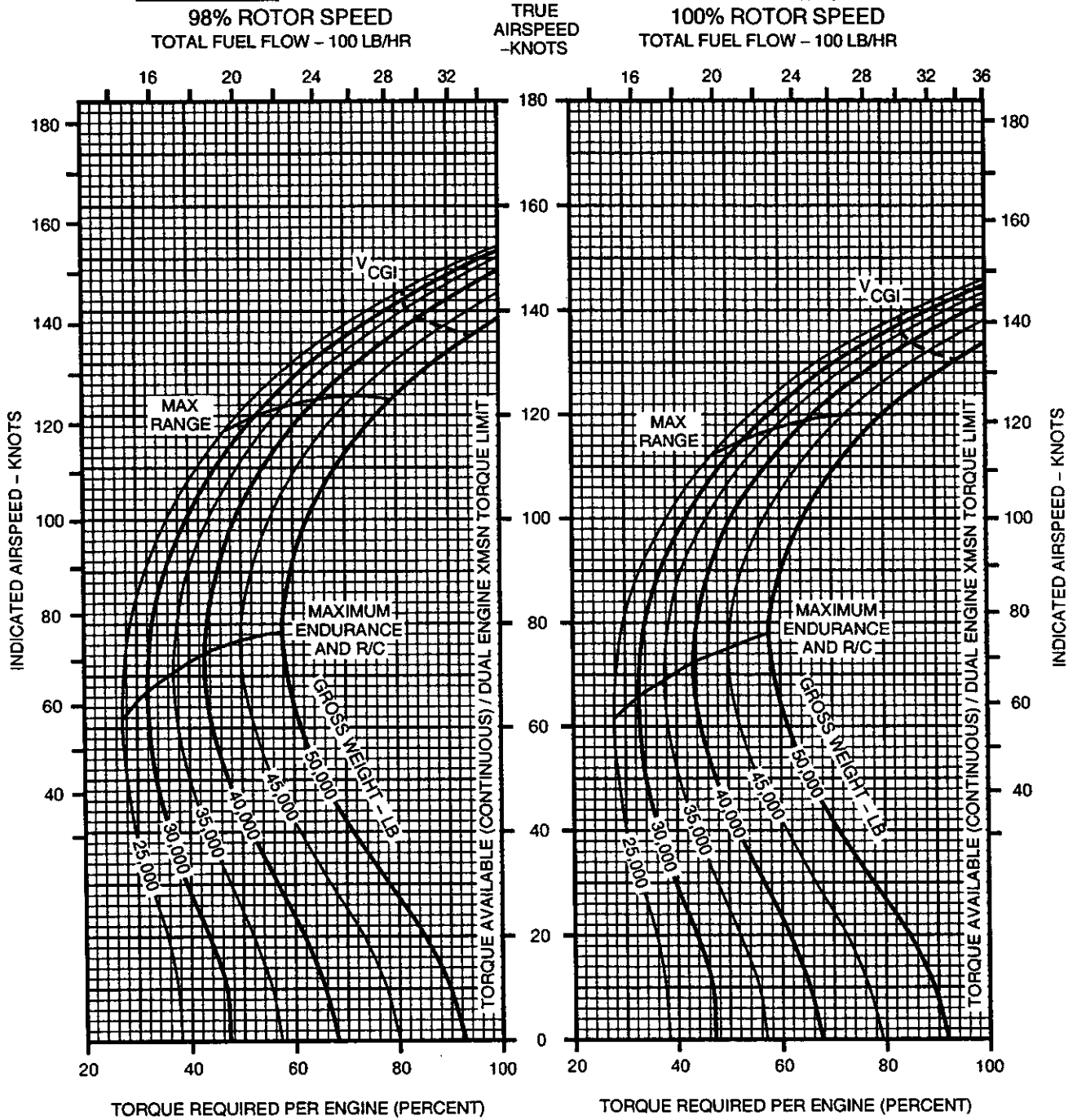
**PRESSURE ALTITUDE - 6000 FT**

**CRUISE  
CH-47D  
(2) T55-GA-714A**

**CLEAN CONFIGURATION**

**FAT = -50°C**

**FAT = -50°C**



DATA BASIS: FLIGHT TEST

A60174

**Figure 7A-34. 98 and 100% Rotor RPM, -50°C, 6,000 Feet**

**CRUISE**

**PRESSURE ALTITUDE - 6000 FT**

**CRUISE  
CH-47D  
(2) T55-GA-714A**

**CLEAN CONFIGURATION**

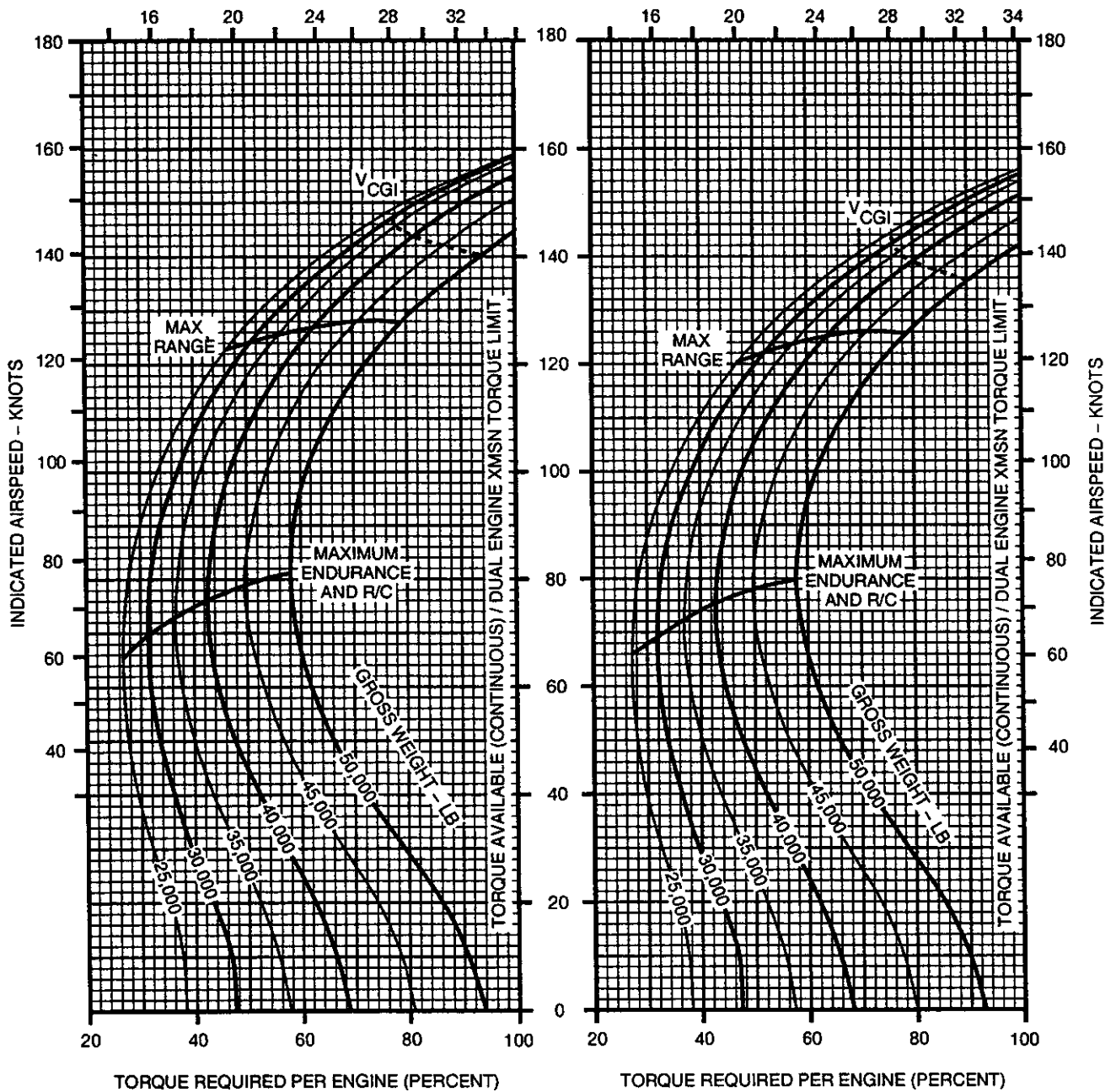
**FAT = -40°C**

**FAT = -40°C**

**98% ROTOR SPEED  
TOTAL FUEL FLOW - 100 LB/HR**

**TRUE  
AIRSPEED  
-KNOTS**

**100% ROTOR SPEED  
TOTAL FUEL FLOW - 100 LB/HR**



DATA BASIS: FLIGHT TEST

**Figure 7A-35. 98 and 100% Rotor RPM, -40°C, 6,000 Feet**

A60175

**CRUISE**

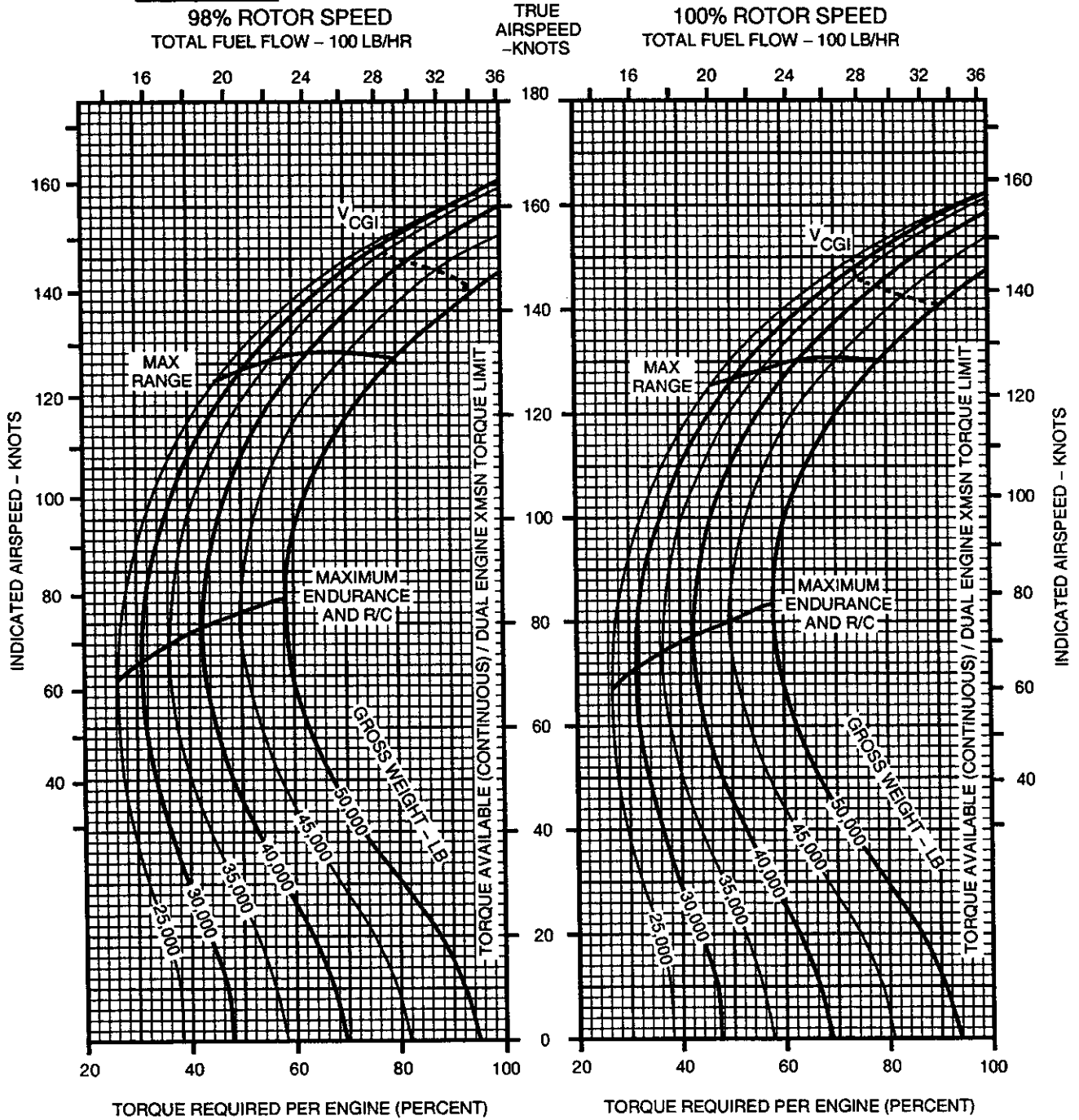
**PRESSURE ALTITUDE - 6000 FT**

**CRUISE  
CH-47D  
(2) T55-GA-714A**

**CLEAN CONFIGURATION**

**FAT = -30°C**

**FAT = -30°C**



DATA BASIS: FLIGHT TEST

A60176

**Figure 7A-36. 98 and 100% Rotor RPM, -30°C, 6,000 Feet**

**CRUISE**

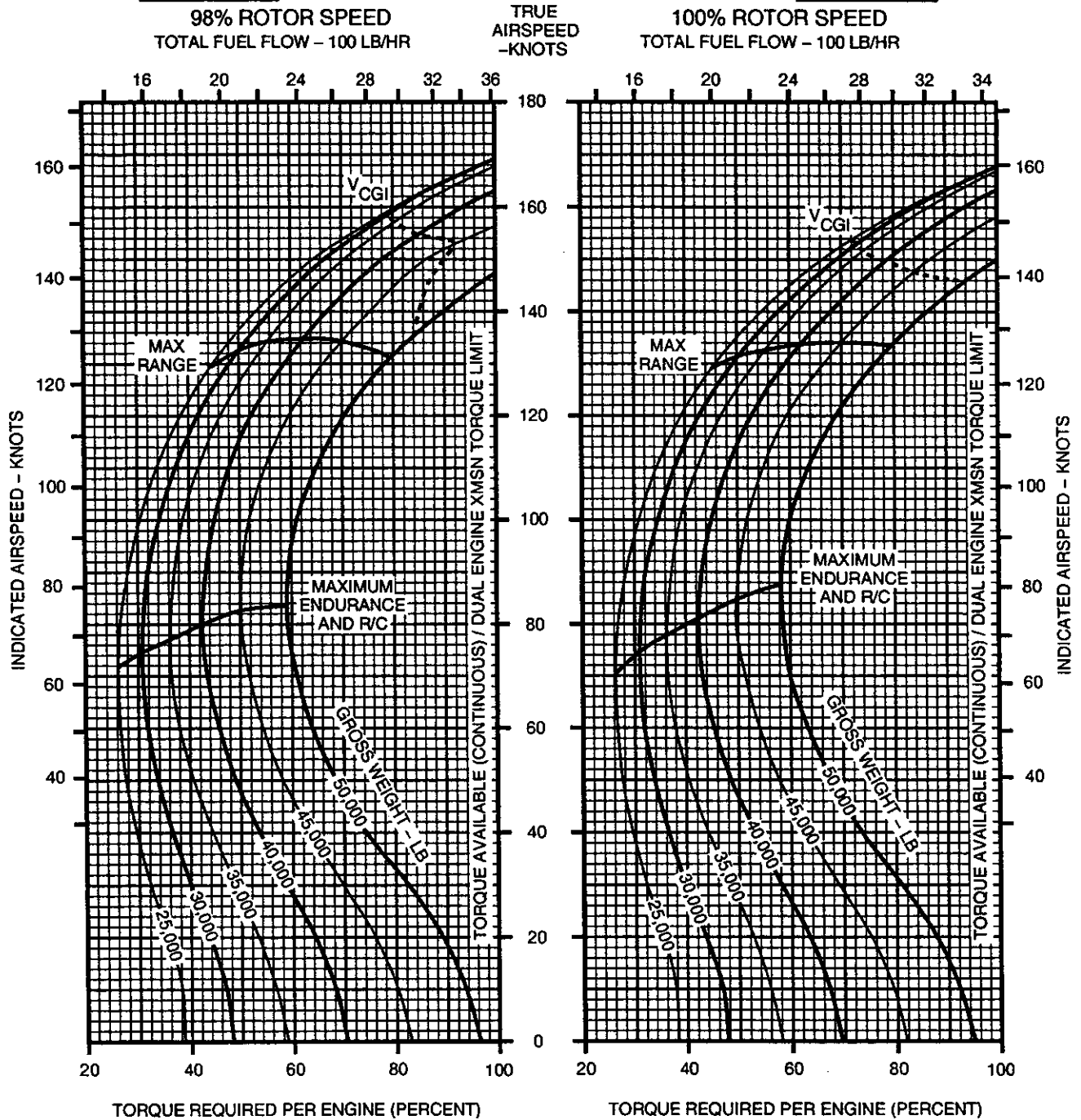
**PRESSURE ALTITUDE - 6000 FT**

**CRUISE  
CH-47D  
(2) T55-GA-714A**

**CLEAN CONFIGURATION**

**FAT = -20°C**

**FAT = -20°C**



DATA BASIS: FLIGHT TEST

**Figure 7A-37. 98 and 100% Rotor RPM, -20°C, 6,000 Feet**

A60177

**CRUISE**

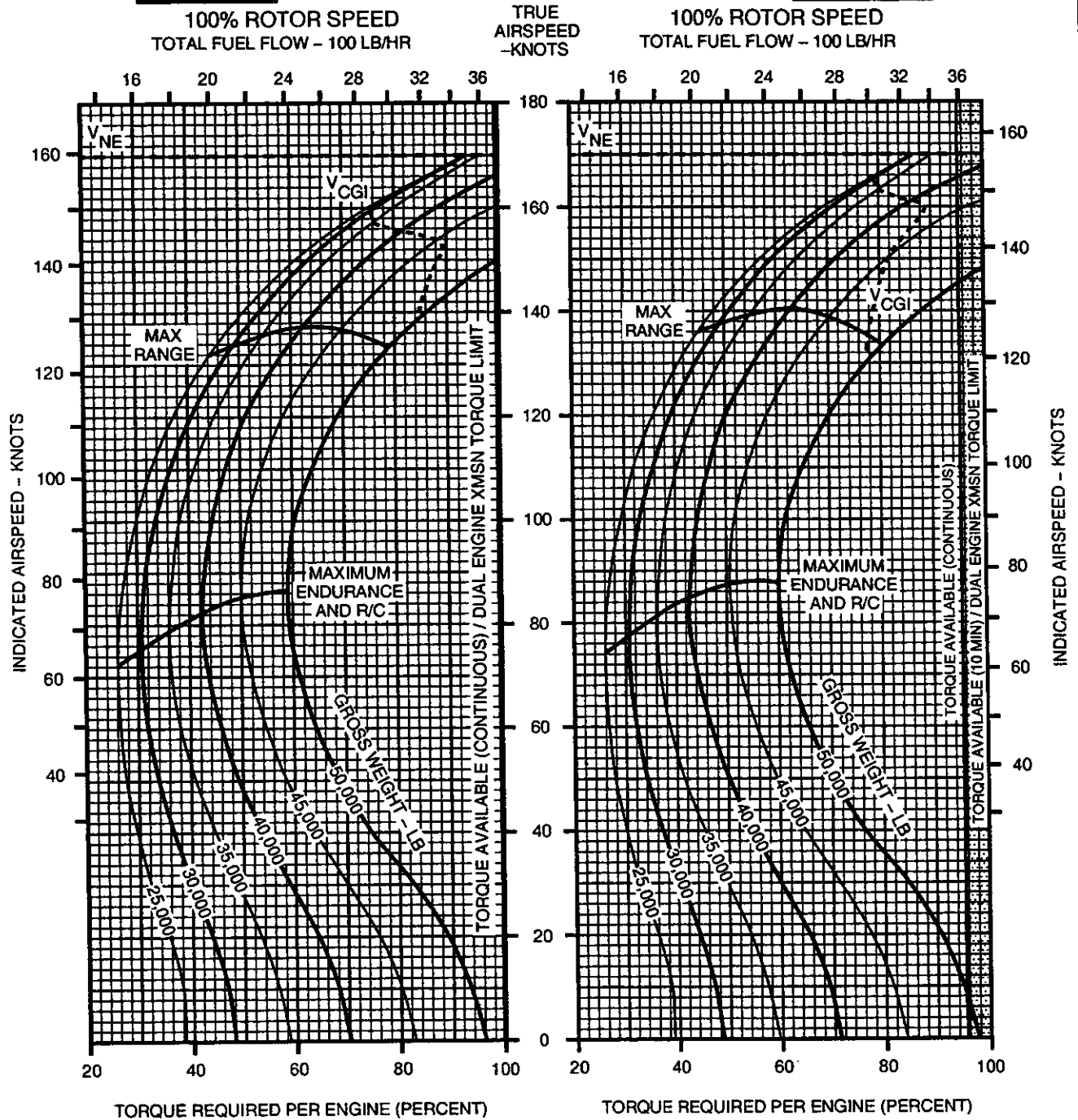
**PRESSURE ALTITUDE - 6000 FT**

**CRUISE  
CH-47D  
(2) T55-GA-714A**

**CLEAN CONFIGURATION**

**FAT = -10°C**

**FAT = 0°C**



DATA BASIS: FLIGHT TEST

A60178

**Figure 7A-38. 100% Rotor RPM, -10° and 0°C, 6,000 Feet**

**CRUISE**

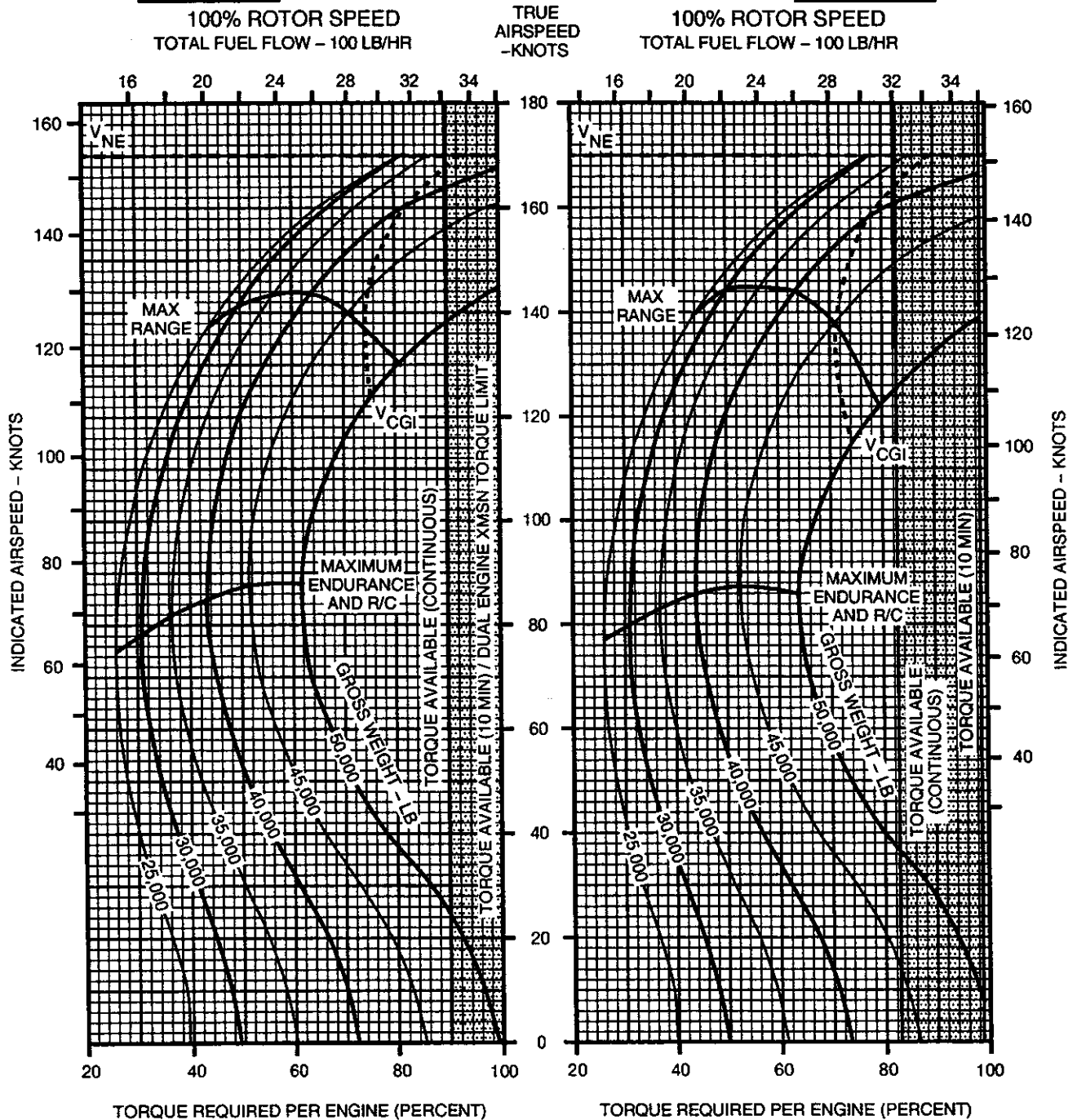
**PRESSURE ALTITUDE - 6000 FT**

**CRUISE  
CH-47D  
(2) T55-GA-714A**

**CLEAN CONFIGURATION**

**FAT = 10°C**

**FAT = 20°C**



DATA BASIS: FLIGHT TEST

**Figure 7A-39. 100% Rotor RPM, 10° and 20° C, 6,000 Feet**

A60179



**CRUISE**

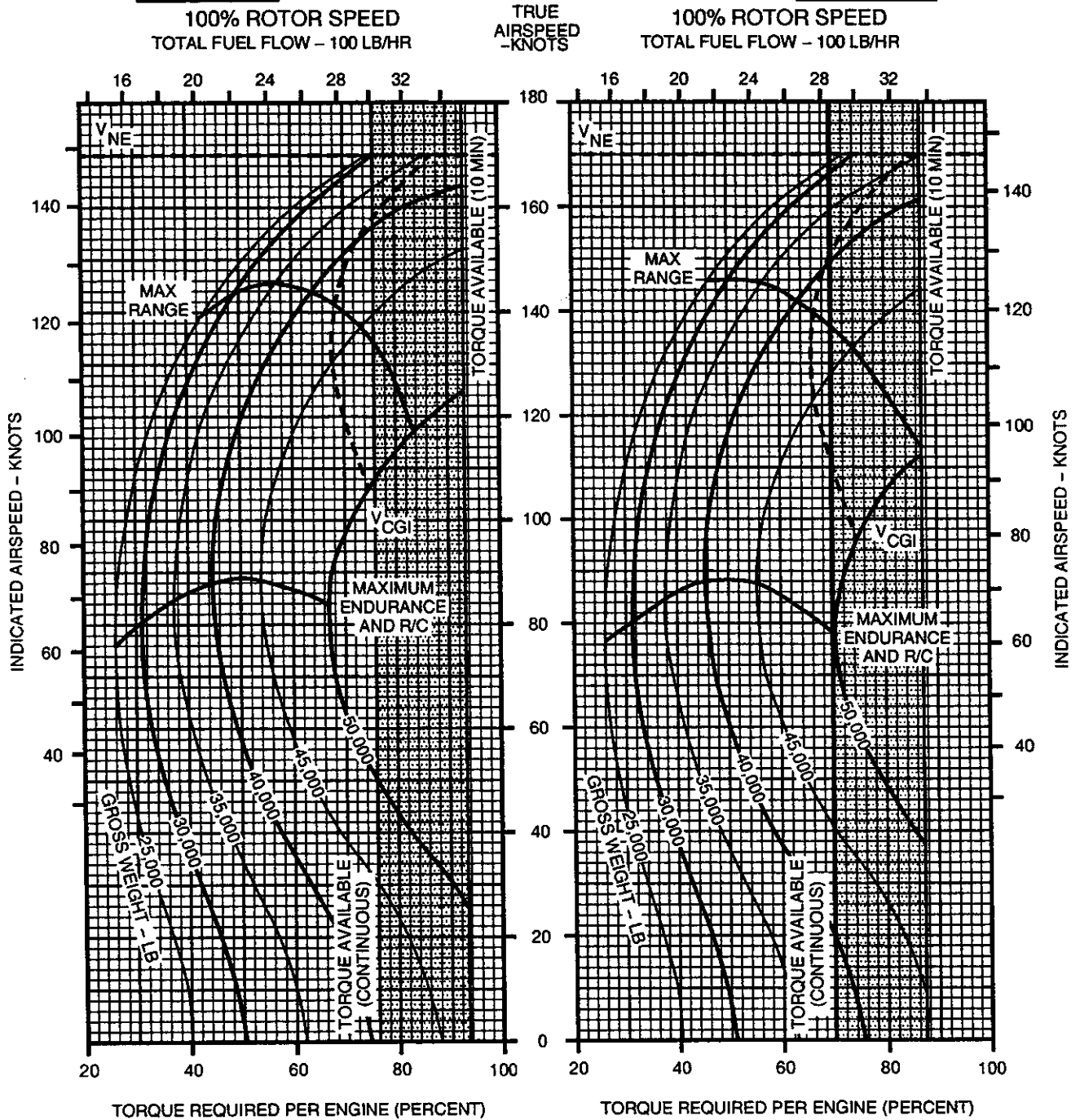
**PRESSURE ALTITUDE - 6000 FT**

**CRUISE  
CH-47D  
(2) T55-GA-714A**

**CLEAN CONFIGURATION**

**FAT = 30°C**

**FAT = 40°C**



DATA BASIS: FLIGHT TEST

A60180

**Figure 7A-40. 100% Rotor RPM, 30° and 40° C, 6,000 Feet**

**CRUISE**

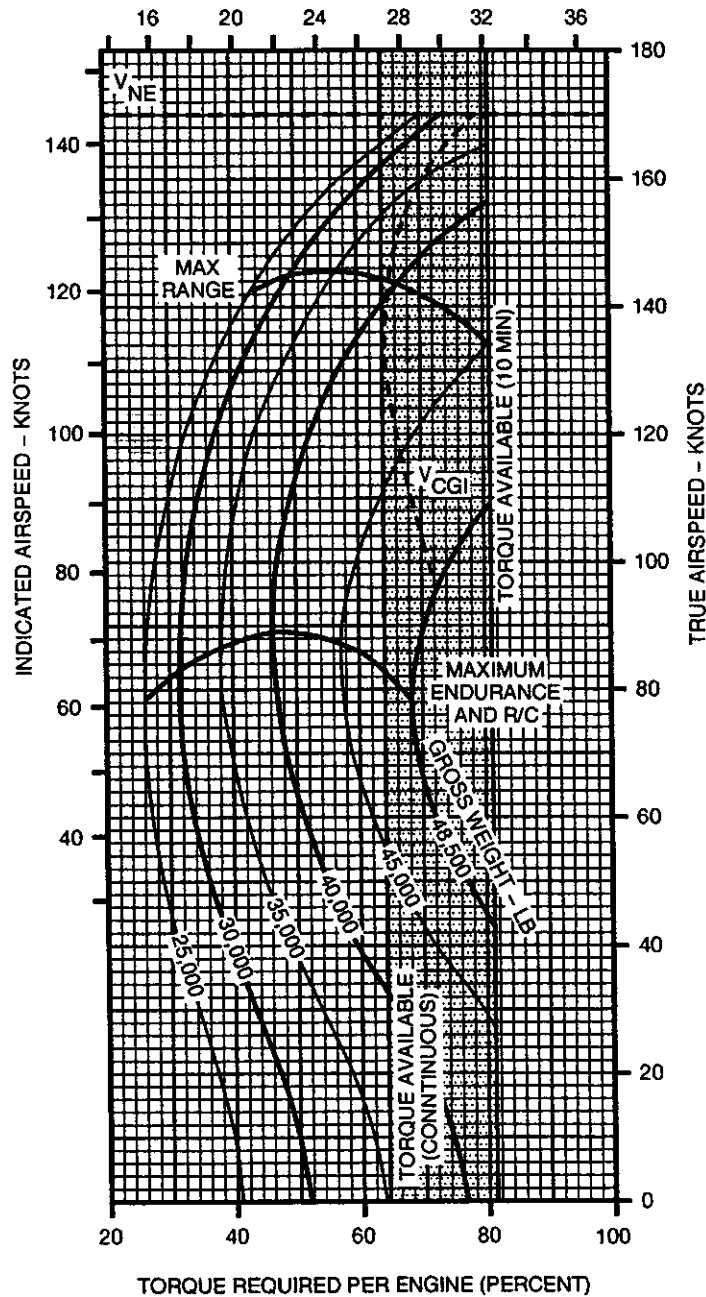
**PRESSURE ALTITUDE - 6000 FT**

**CRUISE  
CH-47D  
(2) T55-GA-714A**

**CLEAN CONFIGURATION**

**FAT = 50°C**

**100% ROTOR SPEED  
TOTAL FUEL FLOW - 100 LB/HR**



DATA BASIS: FLIGHT TEST

**Figure 7A-41. 100% Rotor RPM, 50°C, 6,000 Feet**

A60181

**CRUISE**

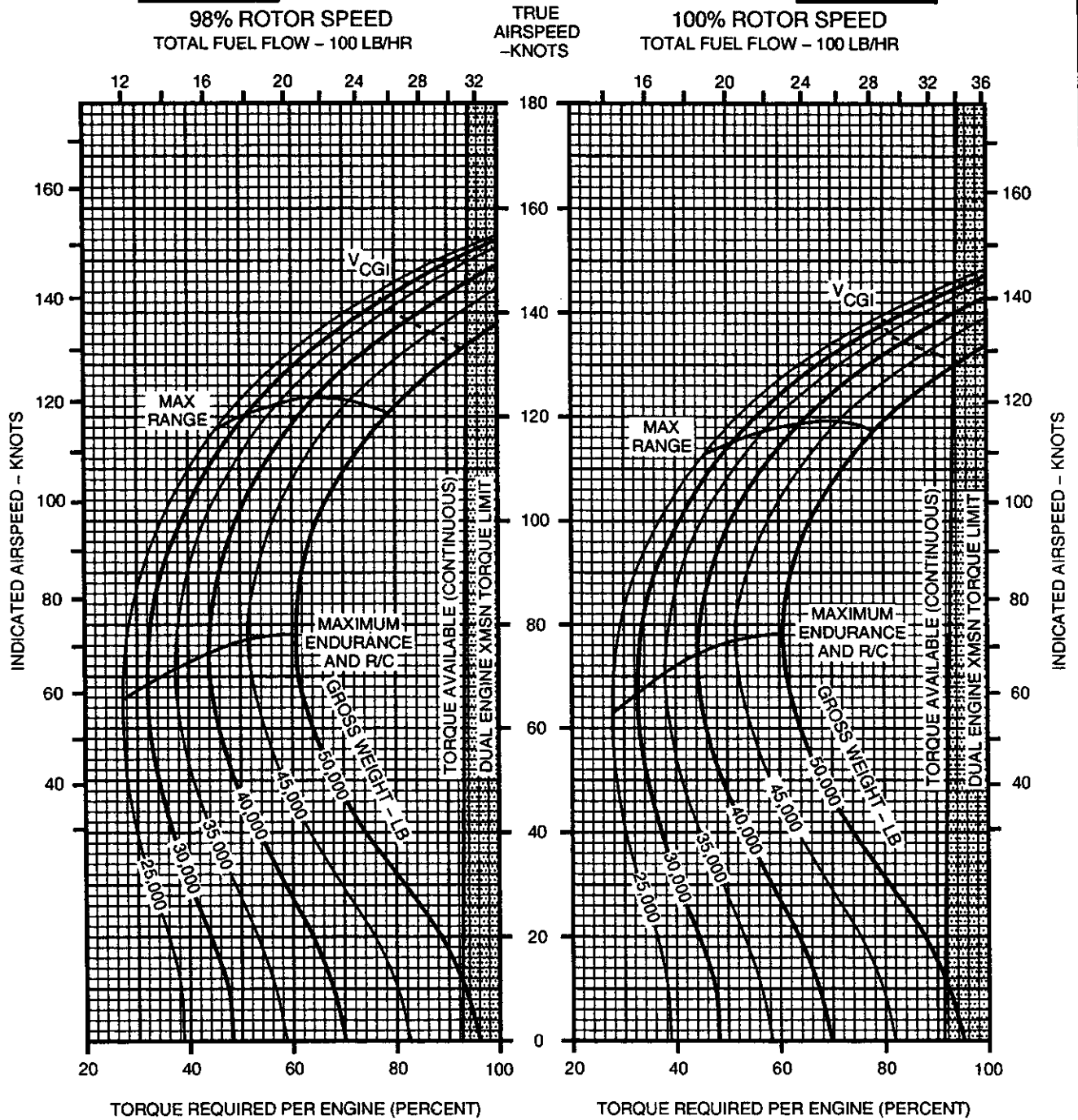
**PRESSURE ALTITUDE - 8000 FT**

**CRUISE  
CH-47D  
(2) T55-GA-714A**

**CLEAN CONFIGURATION**

**FAT = -50°C**

**FAT = -50°C**



DATA BASIS: FLIGHT TEST

A60182

**Figure 7A-42. 98 and 100% RPM, -50°C, 8000 Feet**

**CRUISE**

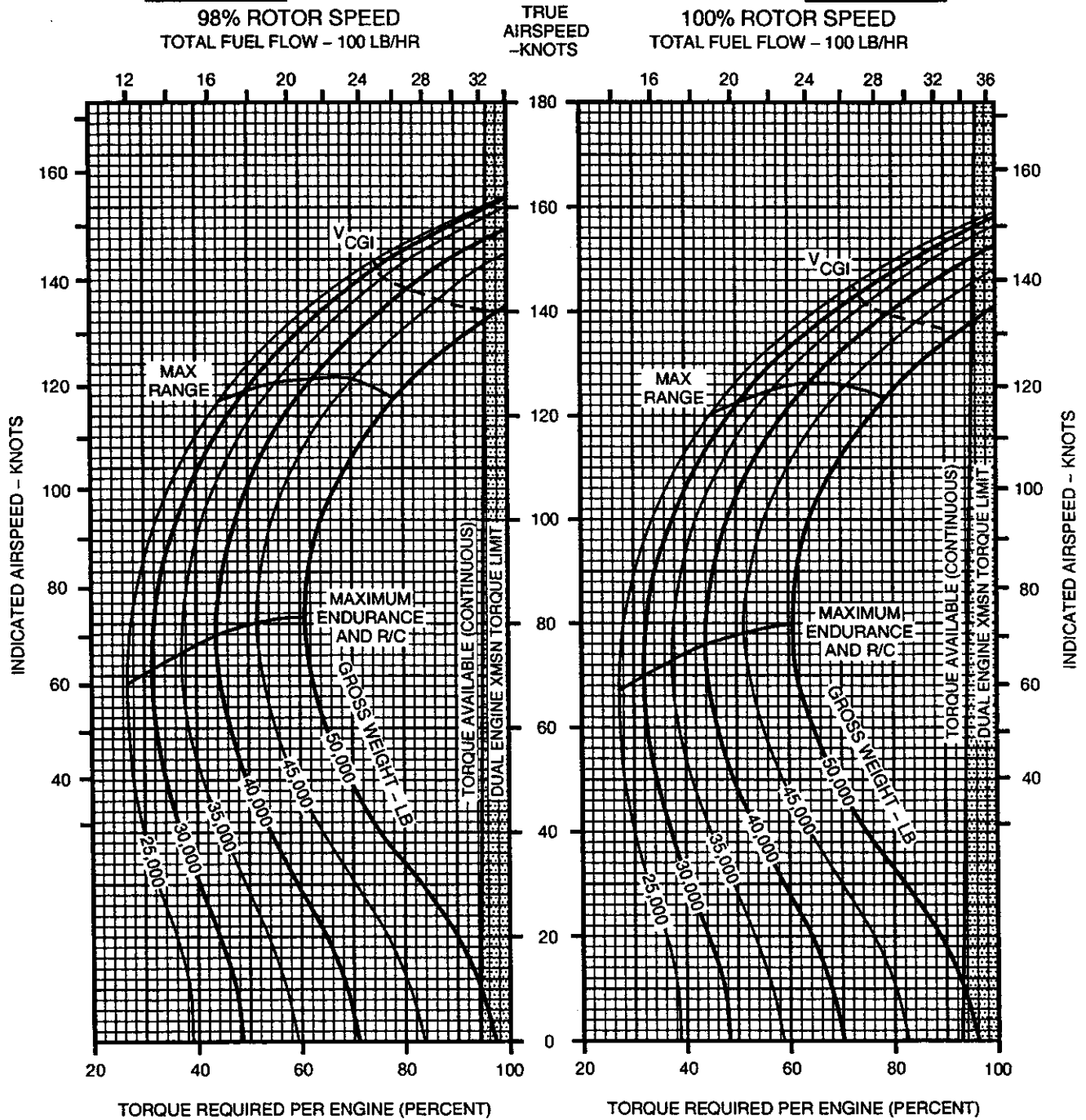
**PRESSURE ALTITUDE - 8000 FT**

**CRUISE  
CH-47D  
(2) T55-GA-714A**

**CLEAN CONFIGURATION**

**FAT = -40°C**

**FAT = -40°C**



DATA BASIS: FLIGHT TEST

**Figure 7A-43. 98 and 100% Rotor RPM, -40°C, 8,000 Feet**

A60183

**CRUISE**

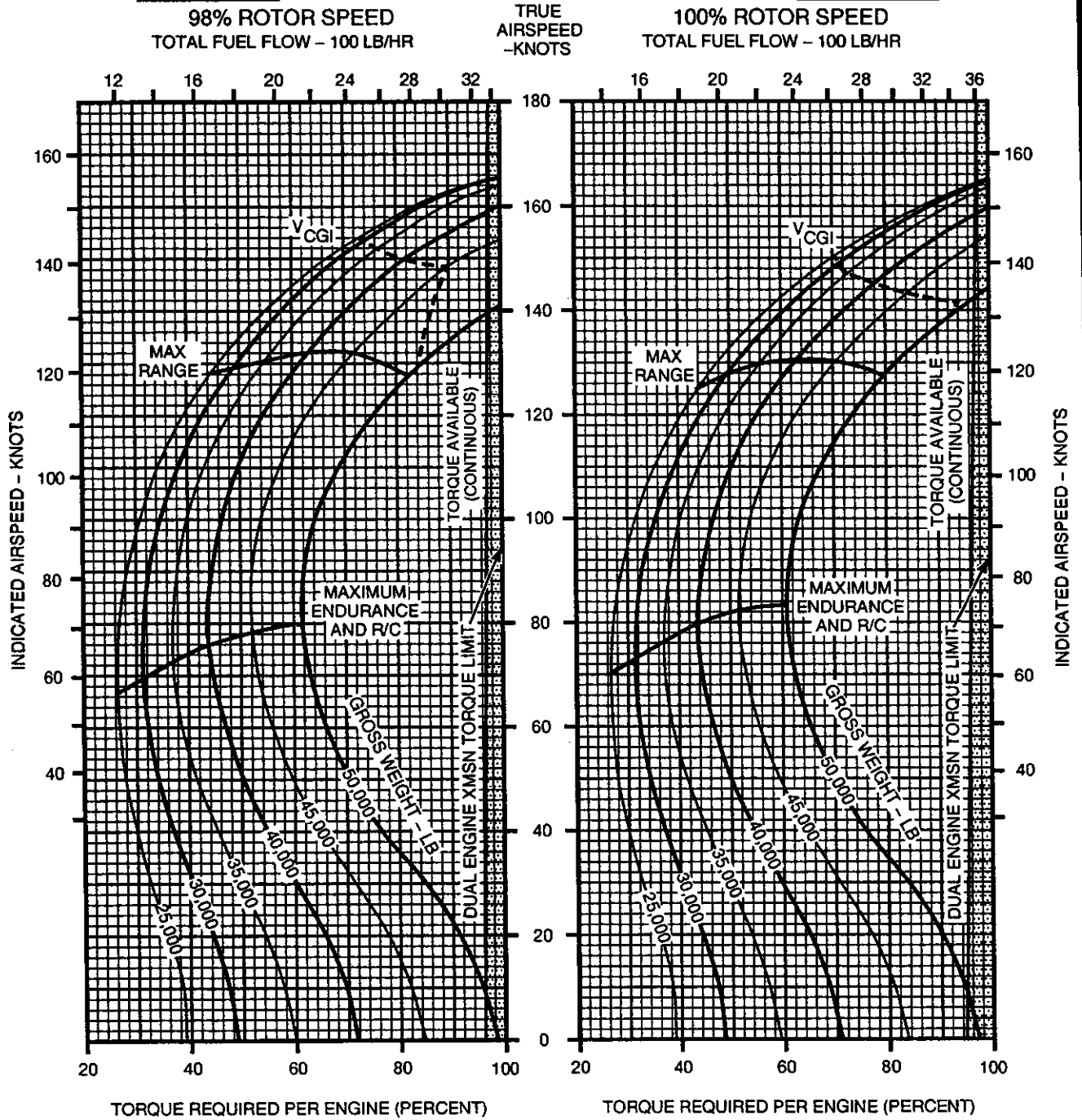
**PRESSURE ALTITUDE - 8000 FT**

**CRUISE  
CH-47D  
(2) T55-GA-714A**

**CLEAN CONFIGURATION**

**FAT = -30°C**

**FAT = -30°C**



DATA BASIS: FLIGHT TEST

A60184

**Figure 7A-44. 98 and 100% Rotor RPM, -30°C, 8,000 Feet**

**CRUISE**

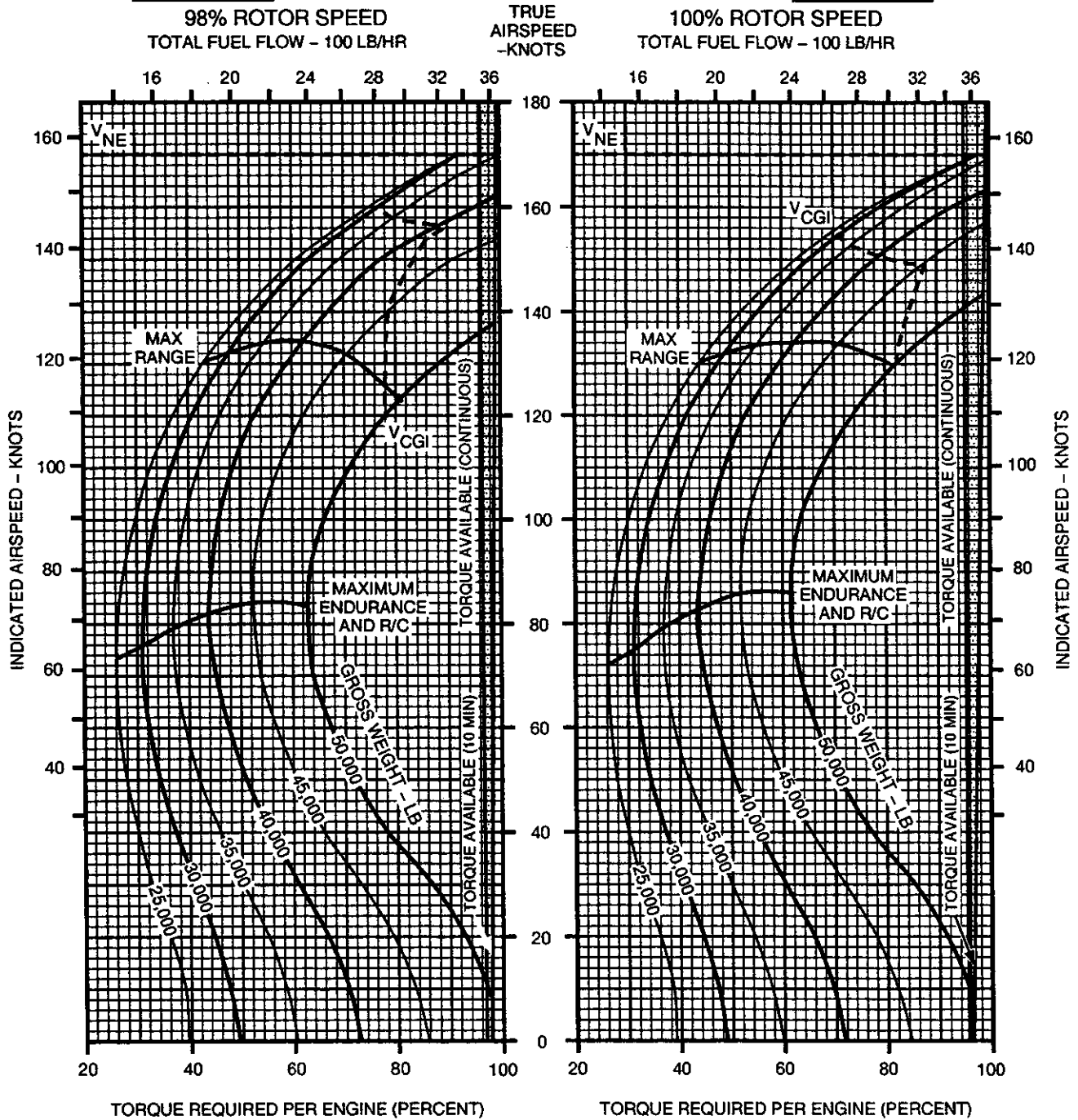
**PRESSURE ALTITUDE - 8000 FT**

**CRUISE  
CH-47D  
(2) T55-GA-714A**

**CLEAN CONFIGURATION**

**FAT = -20°C**

**FAT = -20°C**



DATA BASIS: FLIGHT TEST

**Figure 7A-45. 98 and 100% Rotor RPM, -20°C, 8,000 Feet**

A60185

**CRUISE**

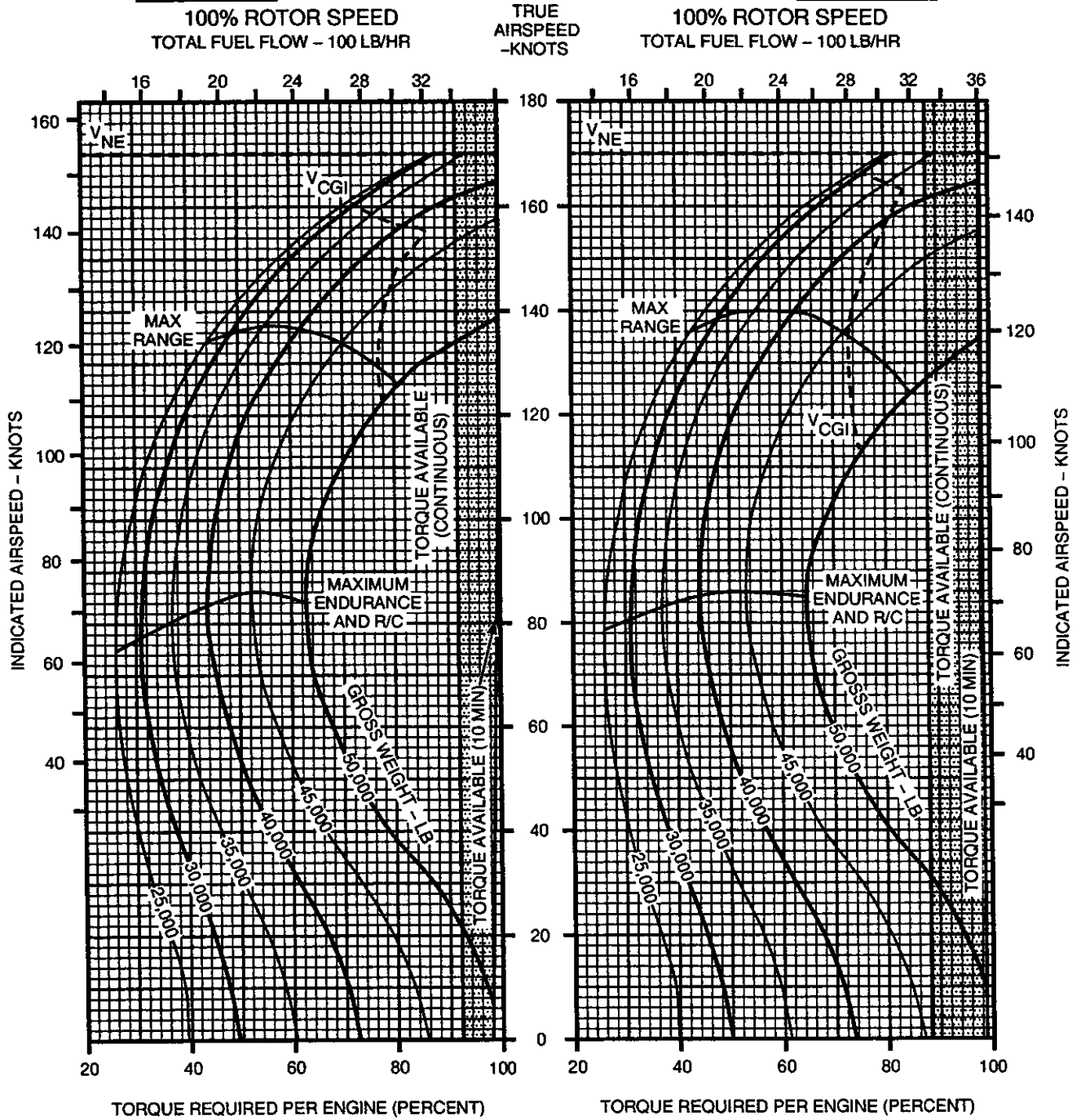
**PRESSURE ALTITUDE - 8000 FT**

**CRUISE  
CH-47D  
(2) T55-GA-714A**

**CLEAN CONFIGURATION**

**FAT = -10°C**

**FAT = 0°C**



DATA BASIS: FLIGHT TEST

A60186

Figure 7A-46. 100% Rotor RPM, -10° and 0° C, 8,000 Feet

**CRUISE**

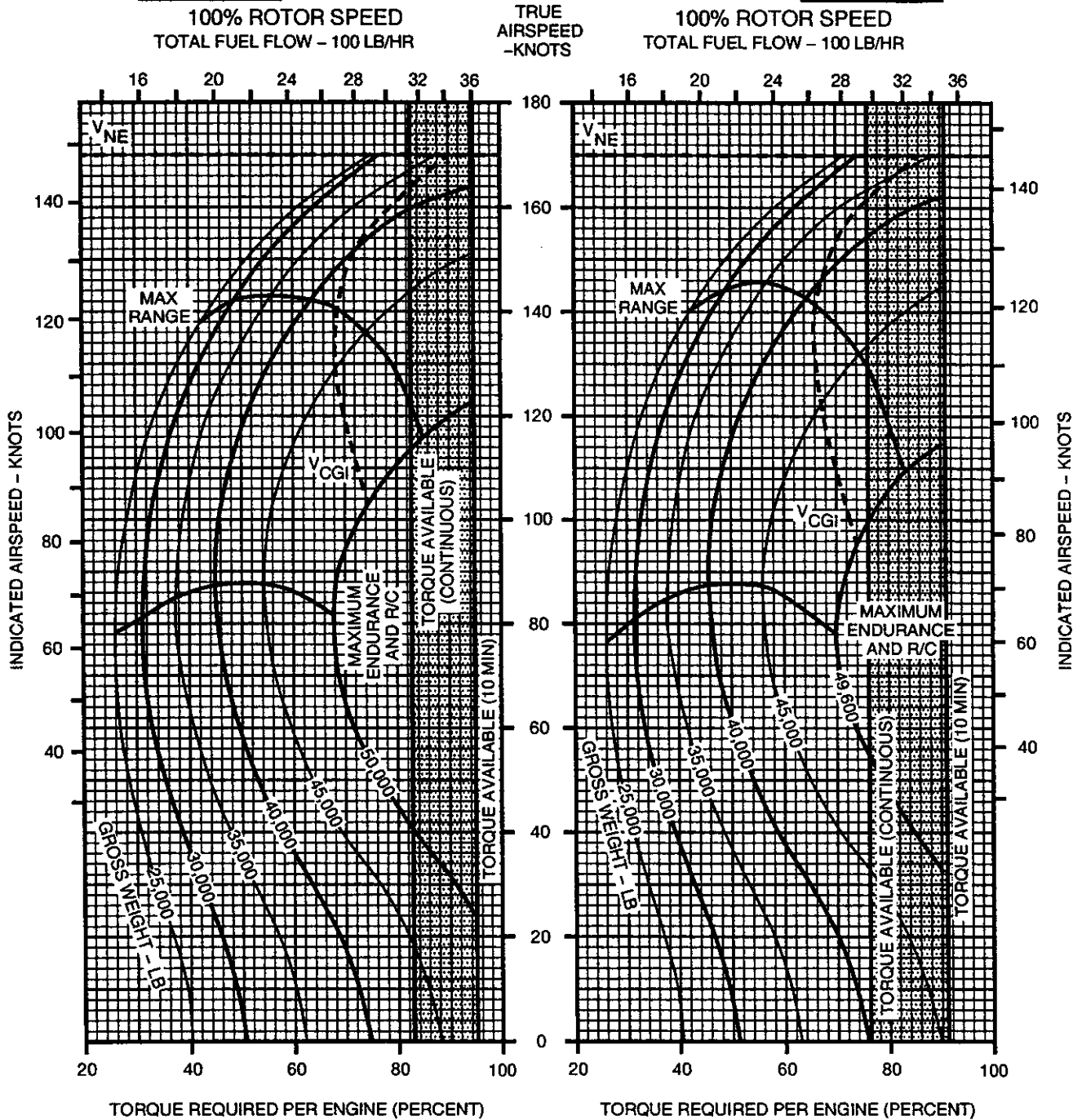
**PRESSURE ALTITUDE - 8000 FT**

**CRUISE  
CH-47D  
(2) T55-GA-714A**

**CLEAN CONFIGURATION**

**FAT = 10°C**

**FAT = 20°C**



DATA BASIS: FLIGHT TEST

**Figure 7A-47. 100% Rotor RPM, 10° and 20° C, 8,000 Feet**

A60187



**CRUISE**

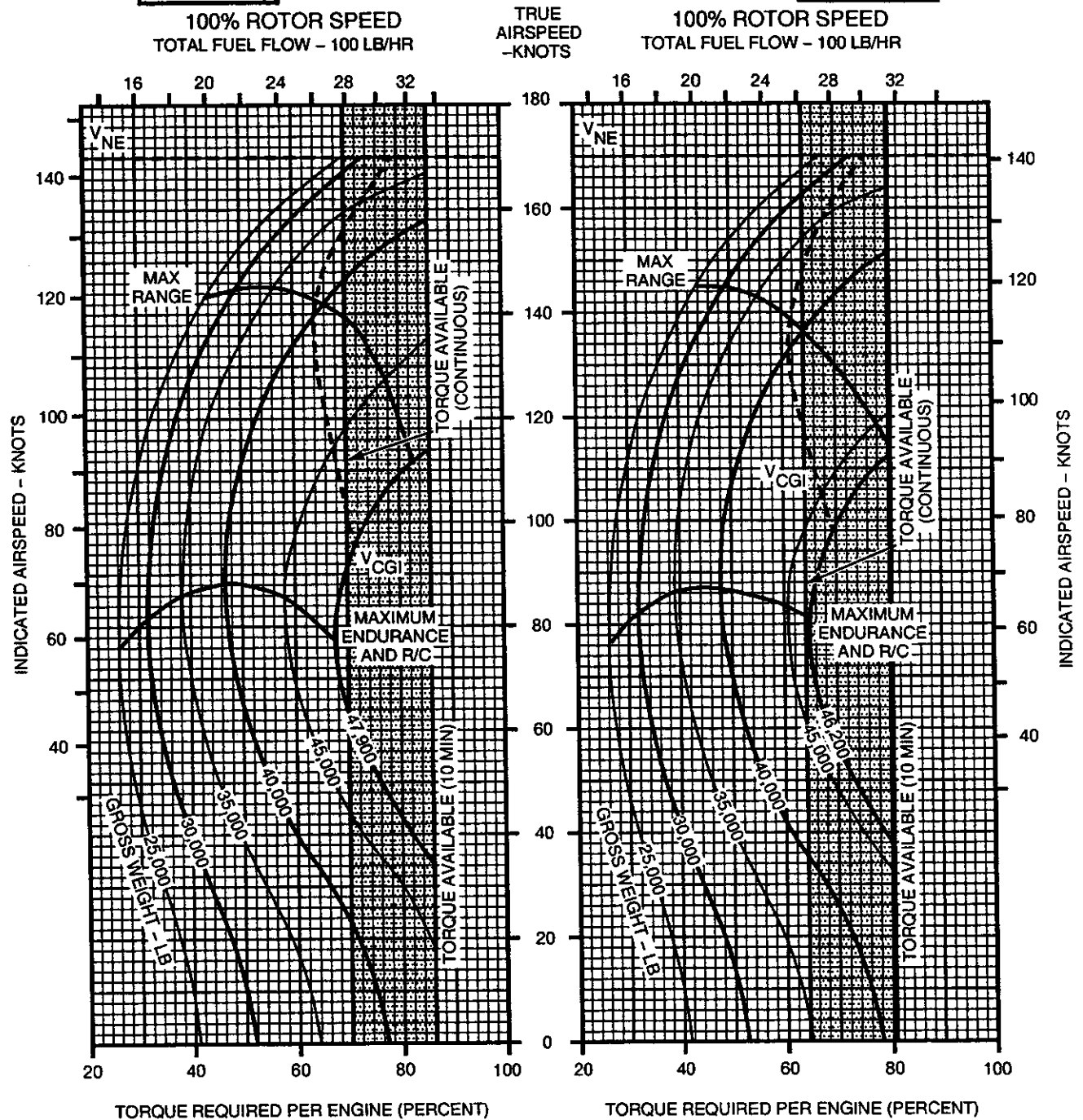
**PRESSURE ALTITUDE - 8000 FT**

**CRUISE  
CH-47D  
(2) T55-GA-714A**

**CLEAN CONFIGURATION**

**FAT = 30°C**

**FAT = 40°C**



DATA BASIS: FLIGHT TEST

A60188

**Figure 7A-48. 100% Rotor RPM, 30° and 40° C, 8,000 Feet**

**CRUISE**

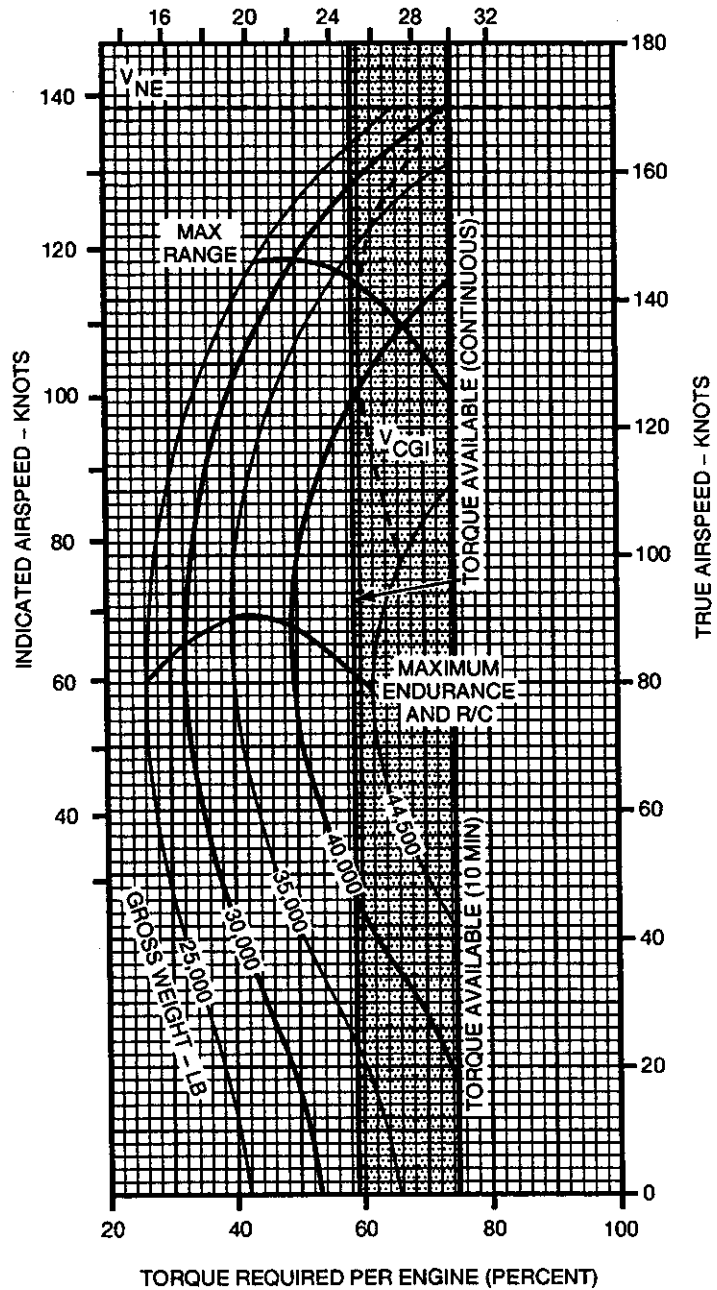
**PRESSURE ALTITUDE - 8000 FT**

**CRUISE  
CH-47D  
(2) T55-GA-714A**

**CLEAN CONFIGURATION**

**FAT = 50°C**

**100% ROTOR SPEED  
TOTAL FUEL FLOW - 100 LB/HR**



DATA BASIS: FLIGHT TEST

**Figure 7A-49. 100% Rotor RPM, 50°C, 8,000 Feet**

A60189

**CRUISE**

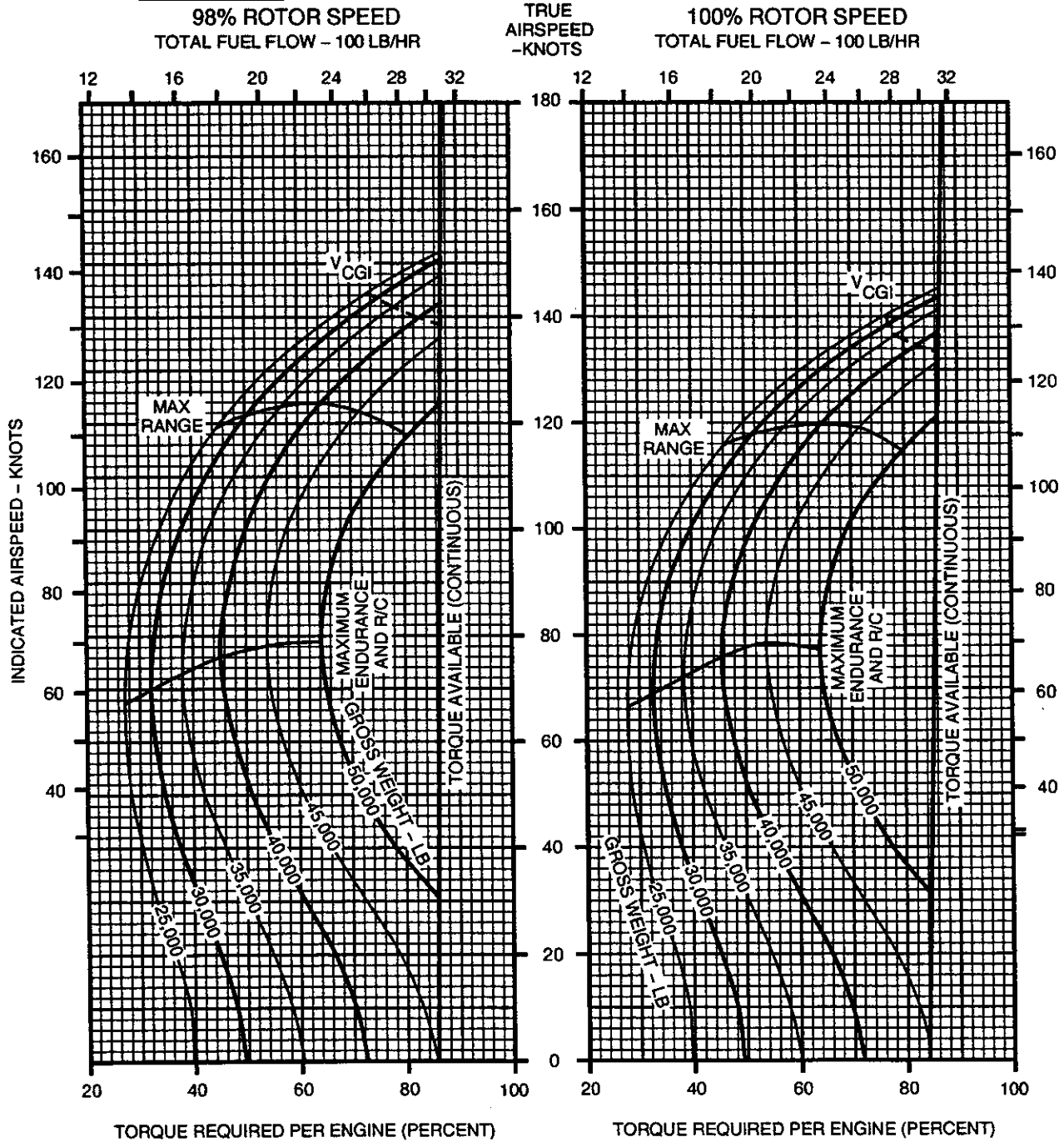
**PRESSURE ALTITUDE - 10000 FT**

**CRUISE  
CH-47D  
(2) T55-GA-714A**

**CLEAN CONFIGURATION**

**FAT = -50°C**

**FAT = -50°C**



DATA BASIS: FLIGHT TEST

A60190

**Figure 7A-50. 98 and 100% Rotor RPM, -50°C, 10,000 Feet**

**CRUISE**

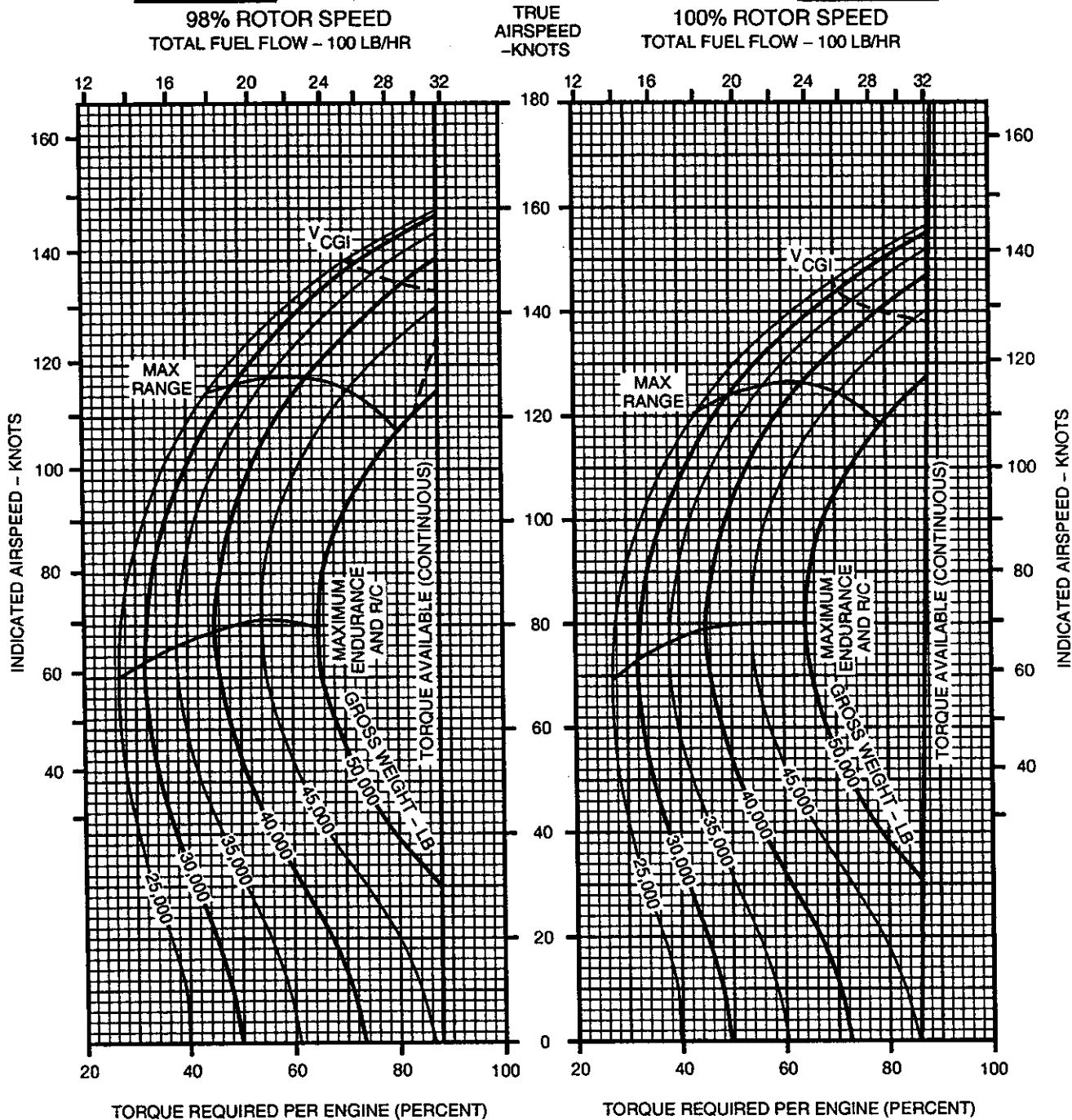
**PRESSURE ALTITUDE - 10000 FT**

**CRUISE  
CH-47D  
(2) T55-GA-714A**

**CLEAN CONFIGURATION**

**FAT = -40°C**

**FAT = -40°C**



DATA BASIS: FLIGHT TEST

**Figure 7A-51. 98 and 100% Rotor RPM, -40°C, 10,000 Feet**

A60191

# CRUISE

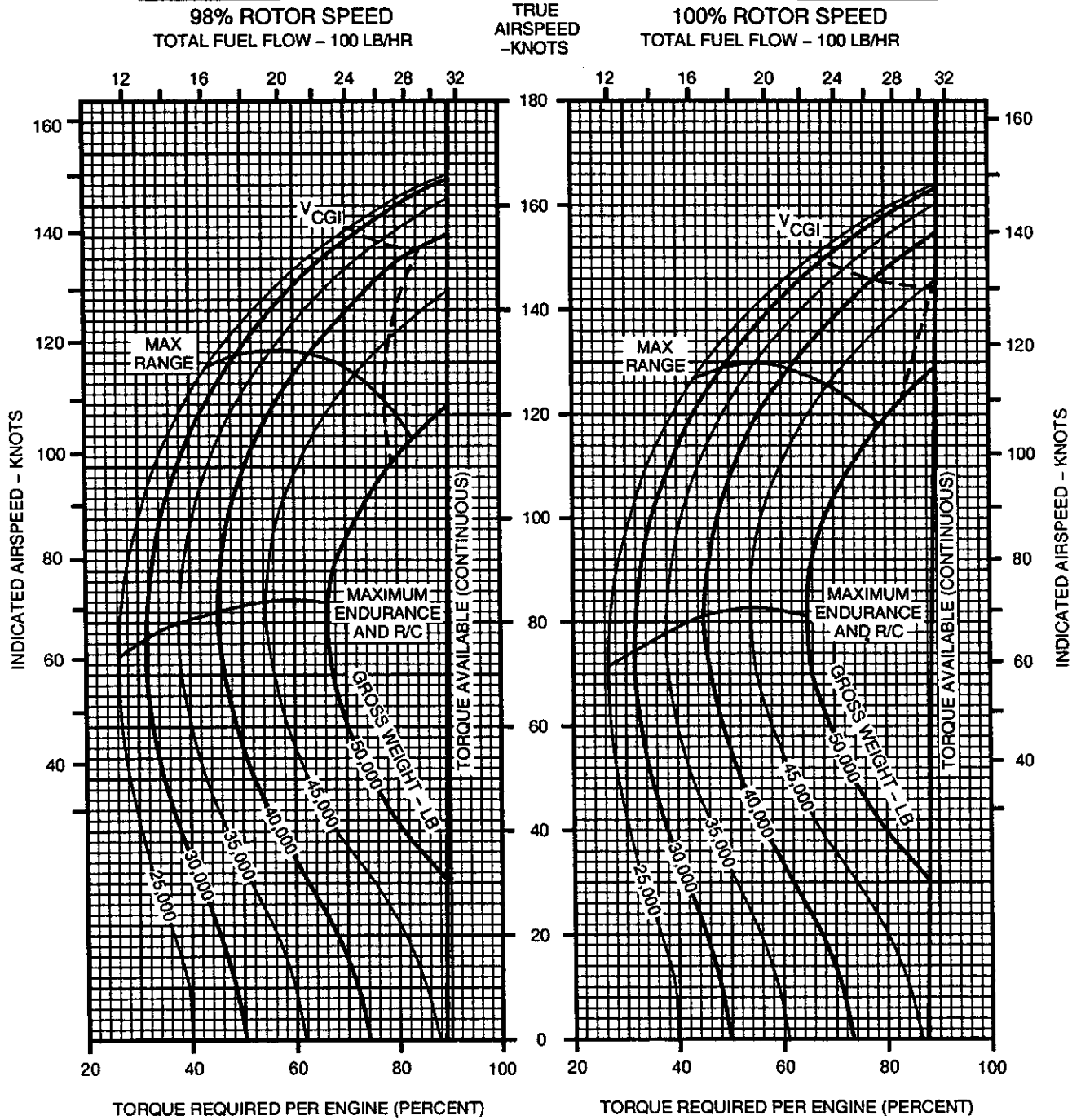
PRESSURE ALTITUDE - 10000 FT

CRUISE  
CH-47D  
(2) T55-GA-714A

CLEAN CONFIGURATION

FAT = -30°C

FAT = -30°C



DATA BASIS: FLIGHT TEST

A60192

Figure 7A-52. 98 and 100% Rotor RPM, -30°C, 10,000 Feet

**CRUISE**

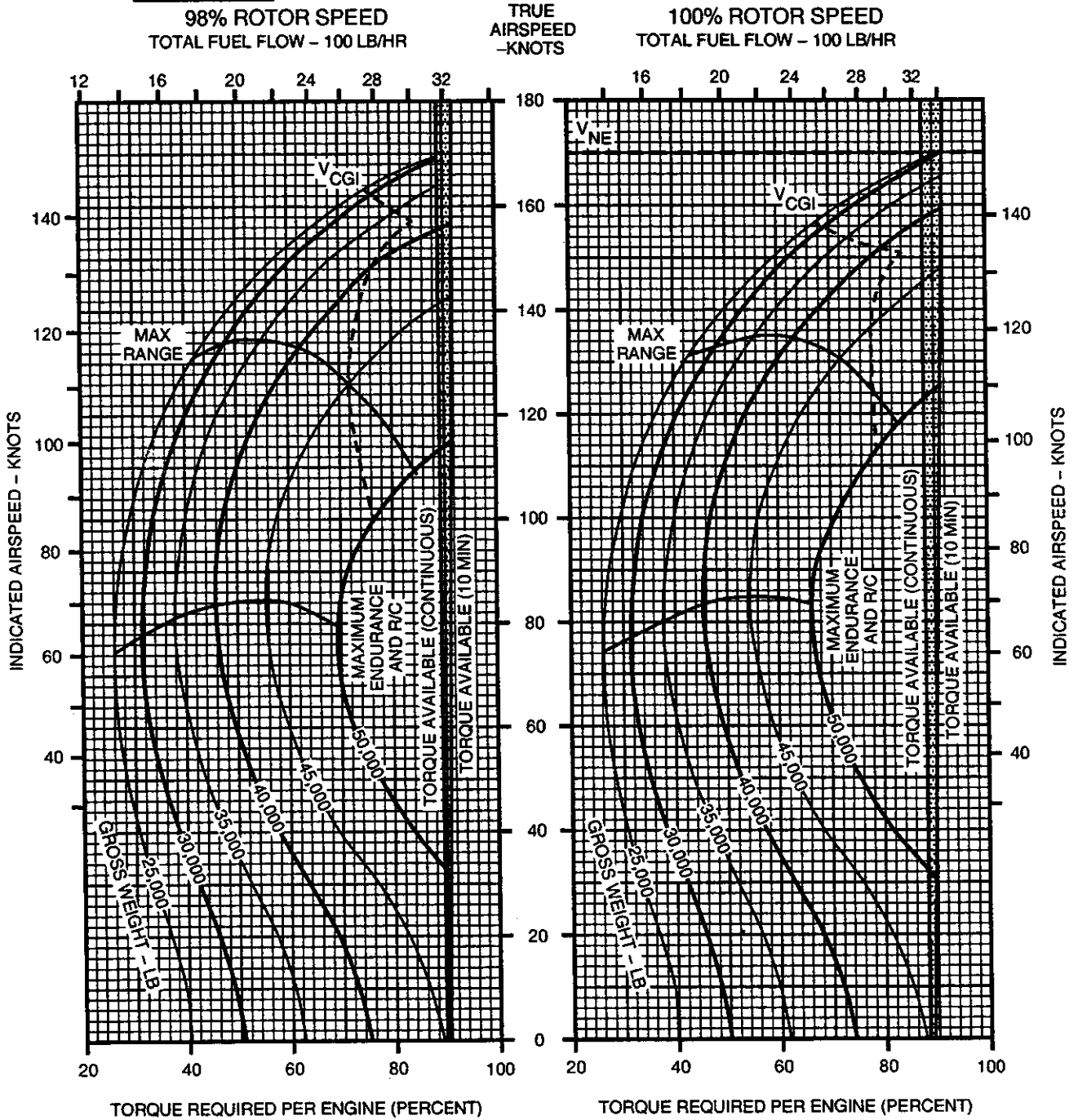
**PRESSURE ALTITUDE - 10000 FT**

**CRUISE  
CH-47D  
(2) T55-GA-714A**

**CLEAN CONFIGURATION**

**FAT = -20°C**

**FAT = -20°C**



DATA BASIS: FLIGHT TEST

**Figure 7A-53. 98 and 100% Rotor RPM, -20°C, 10,000 Feet**

A60193

**CRUISE**

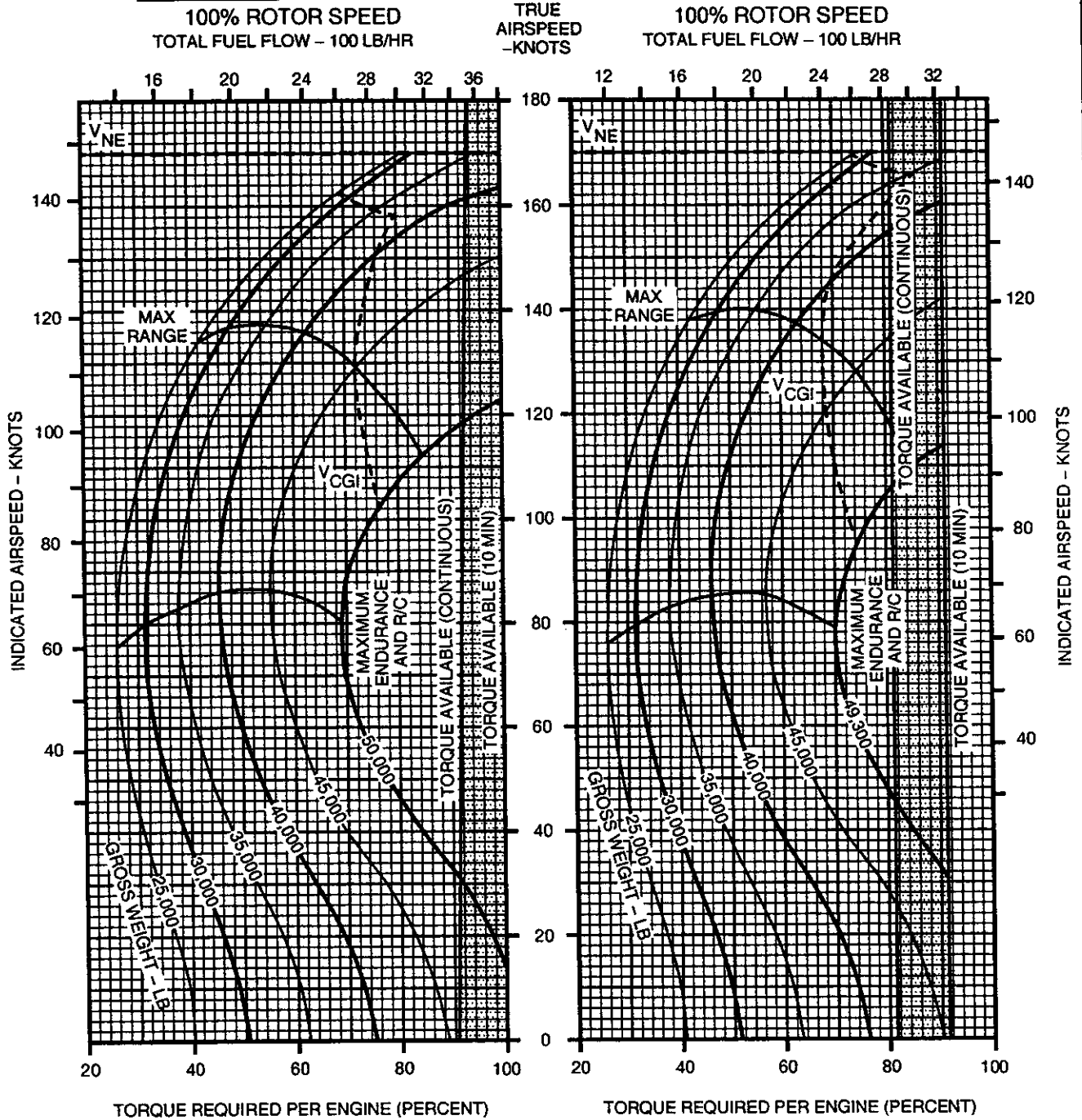
**PRESSURE ALTITUDE - 10000 FT**

**CRUISE  
CH-47D  
(2) T55-GA-714A**

**CLEAN CONFIGURATION**

**FAT = -10°C**

**FAT = 0°C**



DATA BASIS: FLIGHT TEST

A60194

Figure 7A-54. 100% Rotor RPM, -10° and 0° C, 10,000 Feet

**CRUISE**

**PRESSURE ALTITUDE - 10000 FT**

**CRUISE  
CH-47D  
(2) T55-GA-714A**

**CLEAN CONFIGURATION**

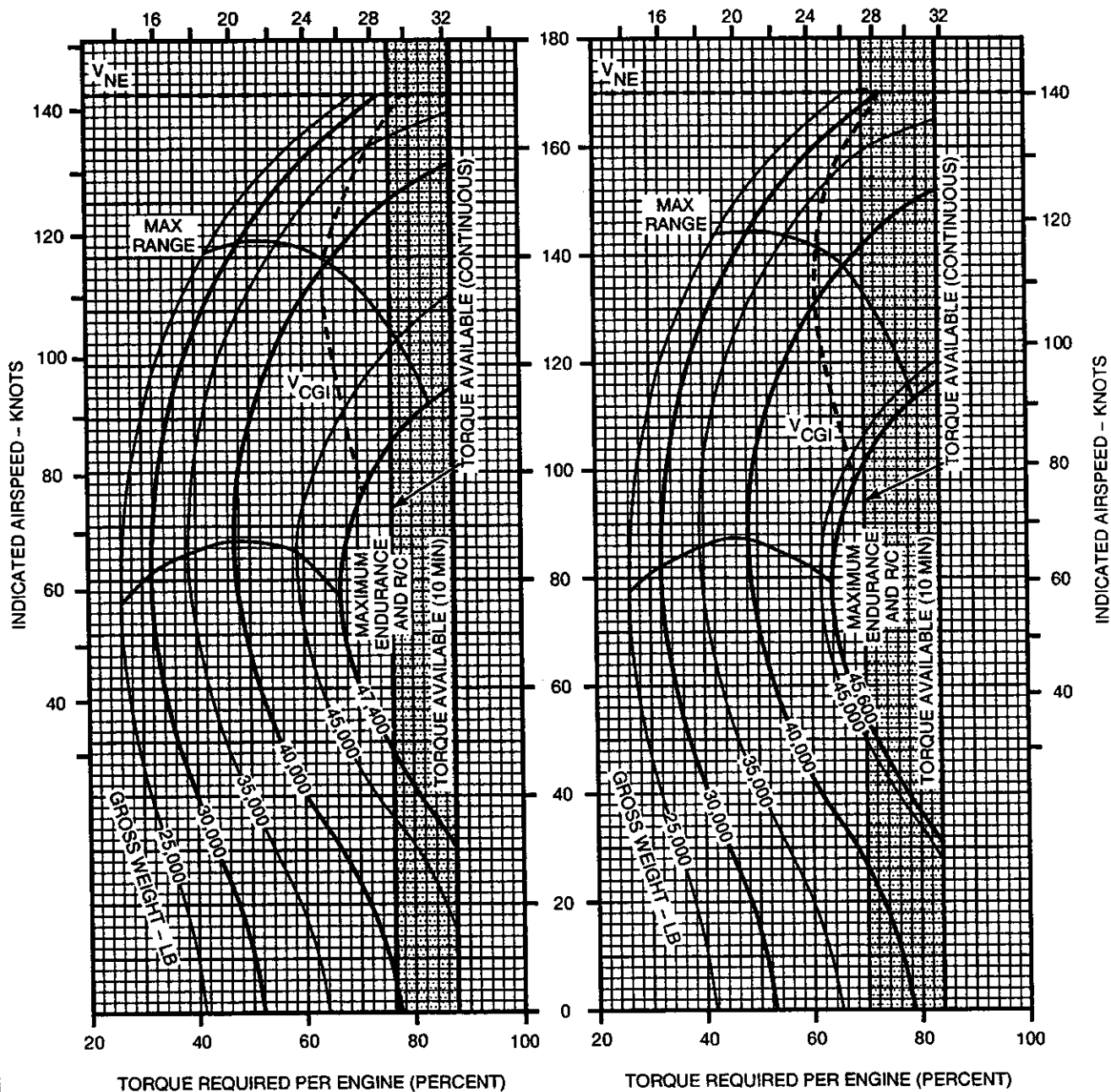
**FAT = 10°C**

**FAT = 20°C**

**100% ROTOR SPEED  
TOTAL FUEL FLOW - 100 LB/HR**

**TRUE  
AIRSPEED  
-KNOTS**

**100% ROTOR SPEED  
TOTAL FUEL FLOW - 100 LB/HR**



DATA BASIS: FLIGHT TEST

**Figure 7A-55. 100% Rotor RPM, 10° and 20° C, 10,000 Feet**

A60195



**CRUISE**

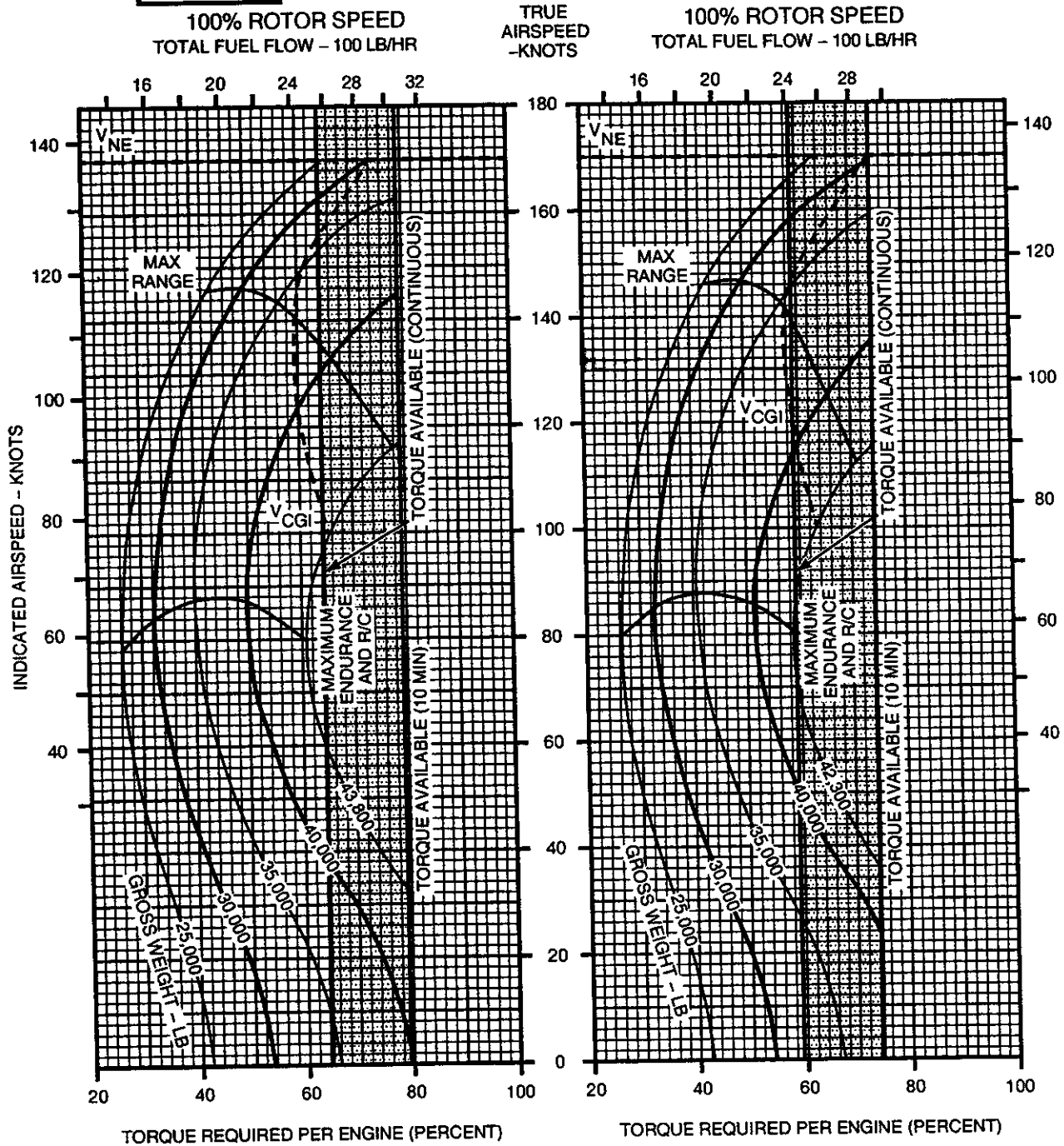
**PRESSURE ALTITUDE - 10000 FT**

**CRUISE  
CH-47D  
(2) T55-GA-714A**

**CLEAN CONFIGURATION**

**FAT = 30°C**

**FAT = 40°C**



DATA BASIS: FLIGHT TEST

A60196

**Figure 7A-56. 100% Rotor RPM, 30° and 40° C, 10,000 Feet**

**CRUISE**

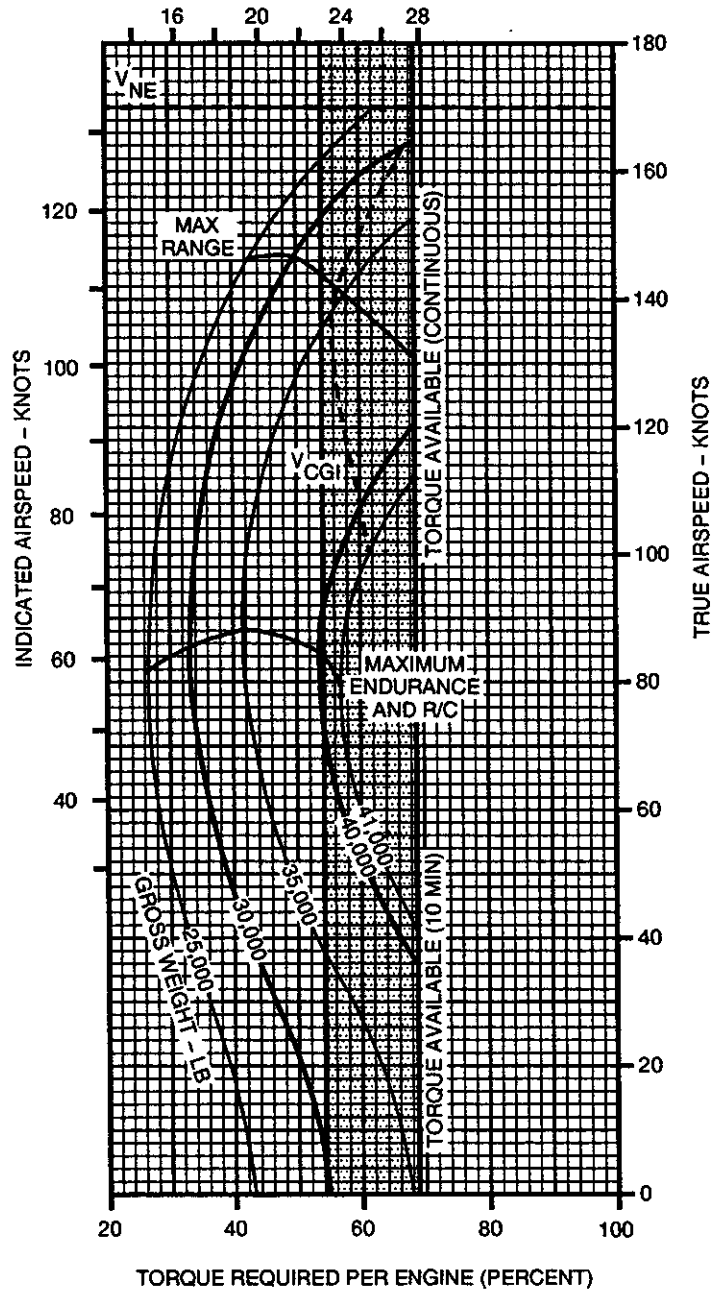
**PRESSURE ALTITUDE - 10000 FT**

**CRUISE  
CH-47D  
(2) T55-GA-714A**

**CLEAN CONFIGURATION**

**FAT= 50°C**

**100% ROTOR SPEED  
TOTAL FUEL FLOW - 100 LB/HR**



DATA BASIS: FLIGHT TEST

**Figure 7A-57. 100% Rotor RPM, 50°C, 10,000 Feet**

A60197

**CRUISE**

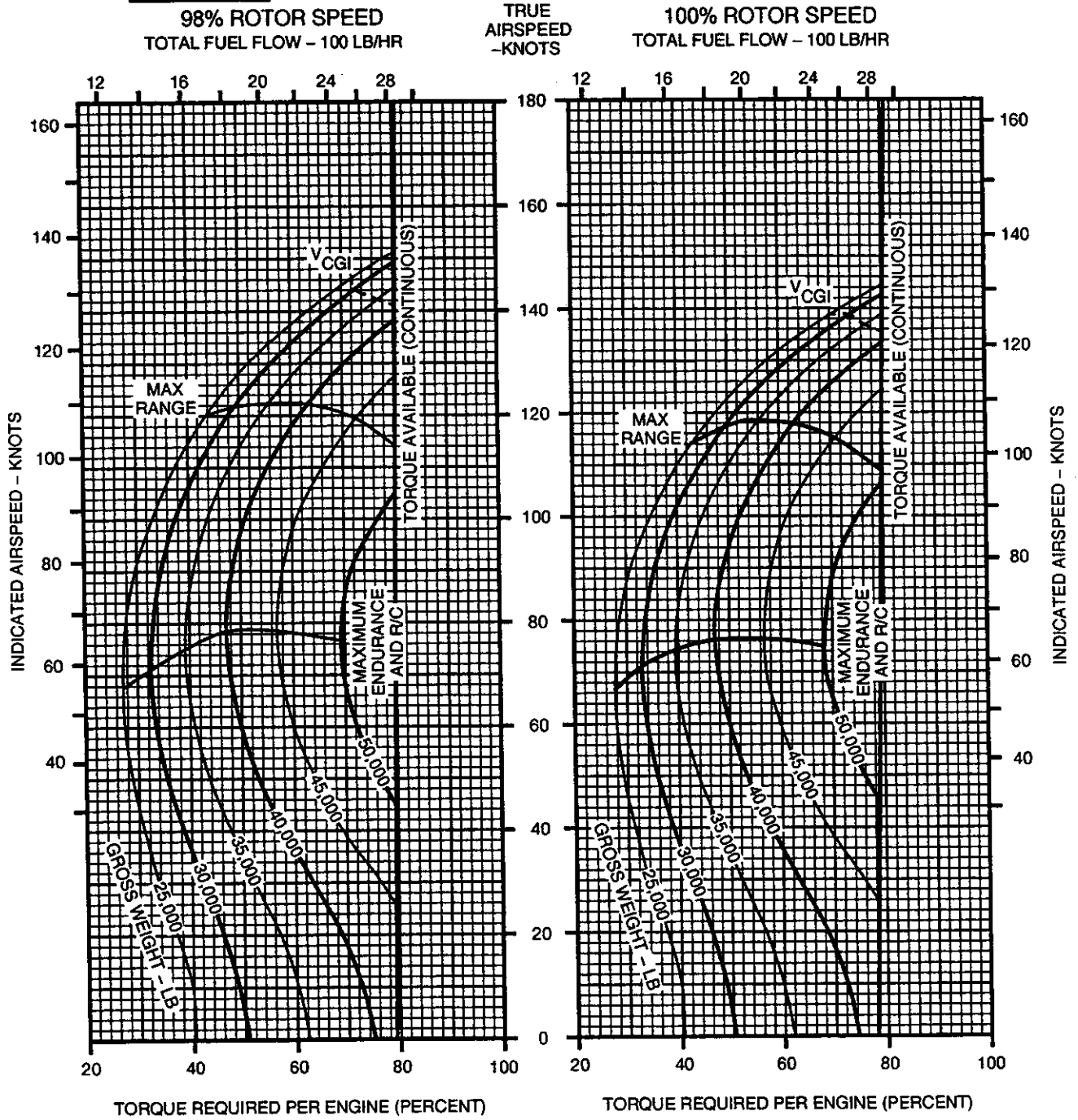
**PRESSURE ALTITUDE - 12000 FT**

**CRUISE  
CH-47D  
(2) T55-GA-714A**

**CLEAN CONFIGURATION**

**FAT = -50°C**

**FAT = -50°C**



DATA BASIS: FLIGHT TEST

A60198

**Figure 7A-58. 98 and 100% Rotor RPM, -50°C, 12,000 Feet**

**CRUISE**

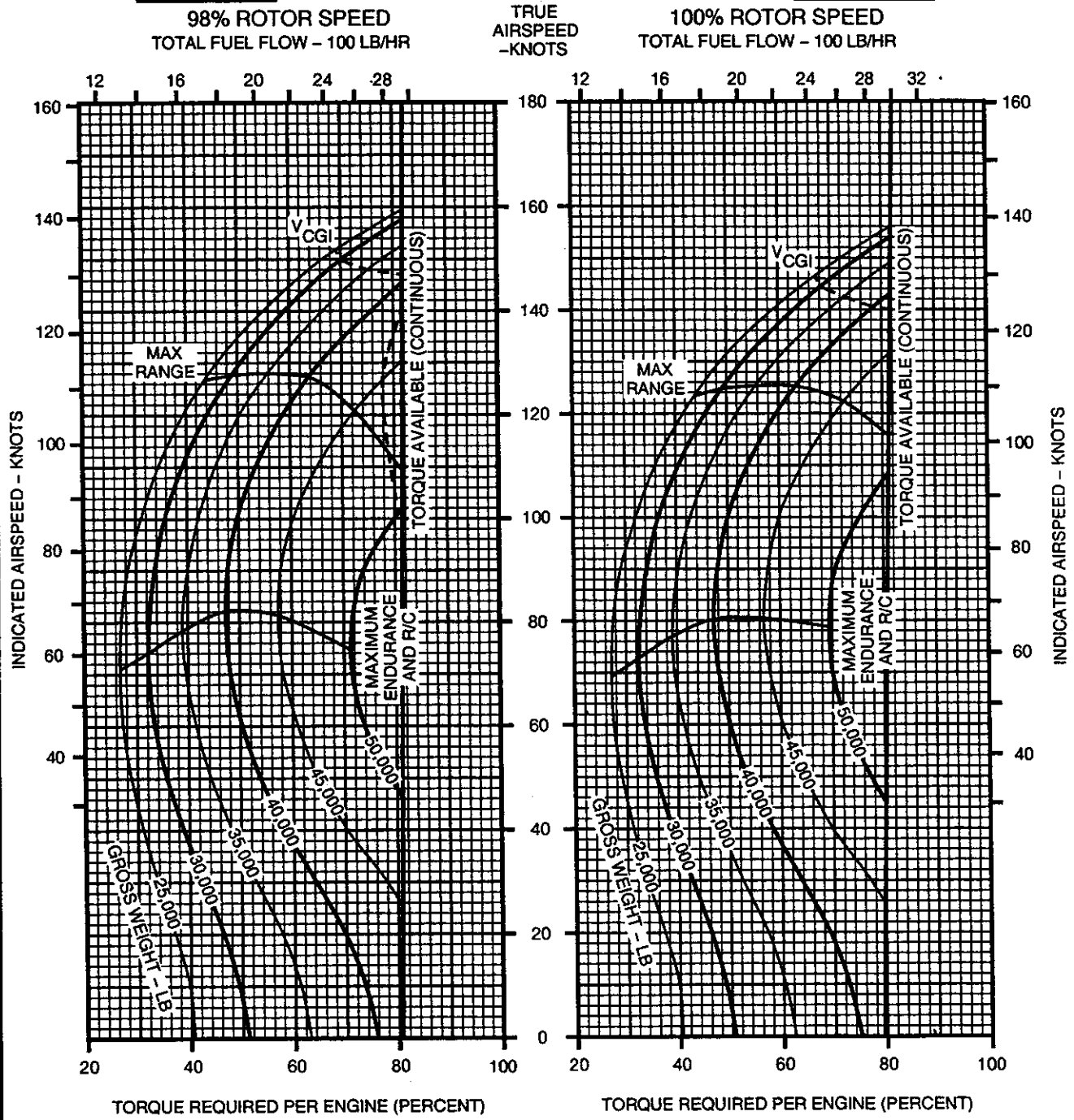
**PRESSURE ALTITUDE - 12000 FT**

**CRUISE  
CH-47D  
(2) T55-GA-714A**

**CLEAN CONFIGURATION**

**FAT = -40°C**

**FAT = -40°C**



DATA BASIS: FLIGHT TEST

**Figure 7A-59. 98 and 100% Rotor RPM, -40°C, 12,000 Feet**

A60199

**CRUISE**

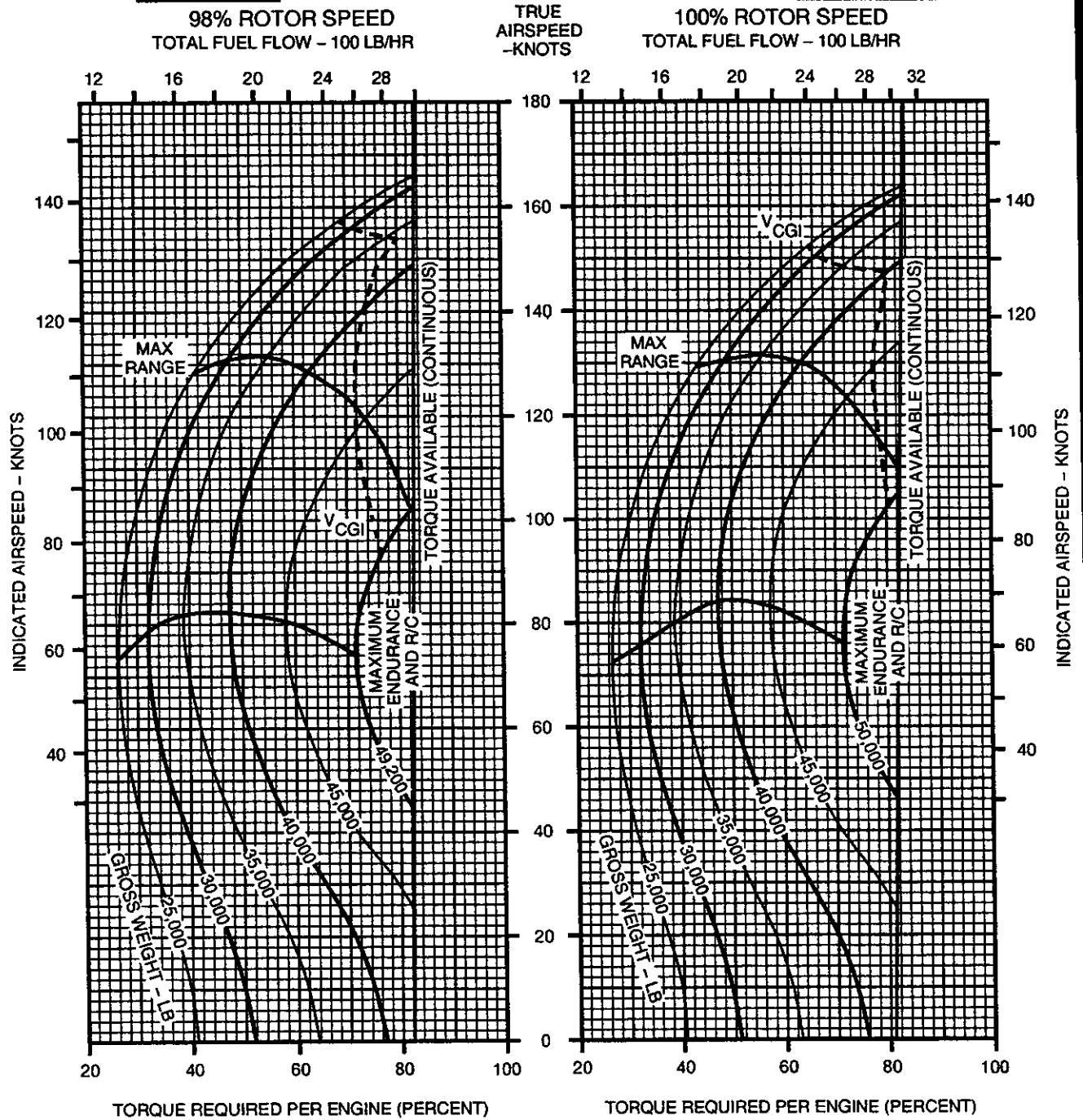
**PRESSURE ALTITUDE - 12000 FT**

**CRUISE  
CH-47D  
(2) T55-GA-714A**

**CLEAN CONFIGURATION**

**FAT = -30°C**

**FAT = -30°C**



DATA BASIS: FLIGHT TEST

A60200

**Figure 7A-60. 98 and 100% Rotor RPM, -30°C, 12,000 Feet**

**CRUISE**

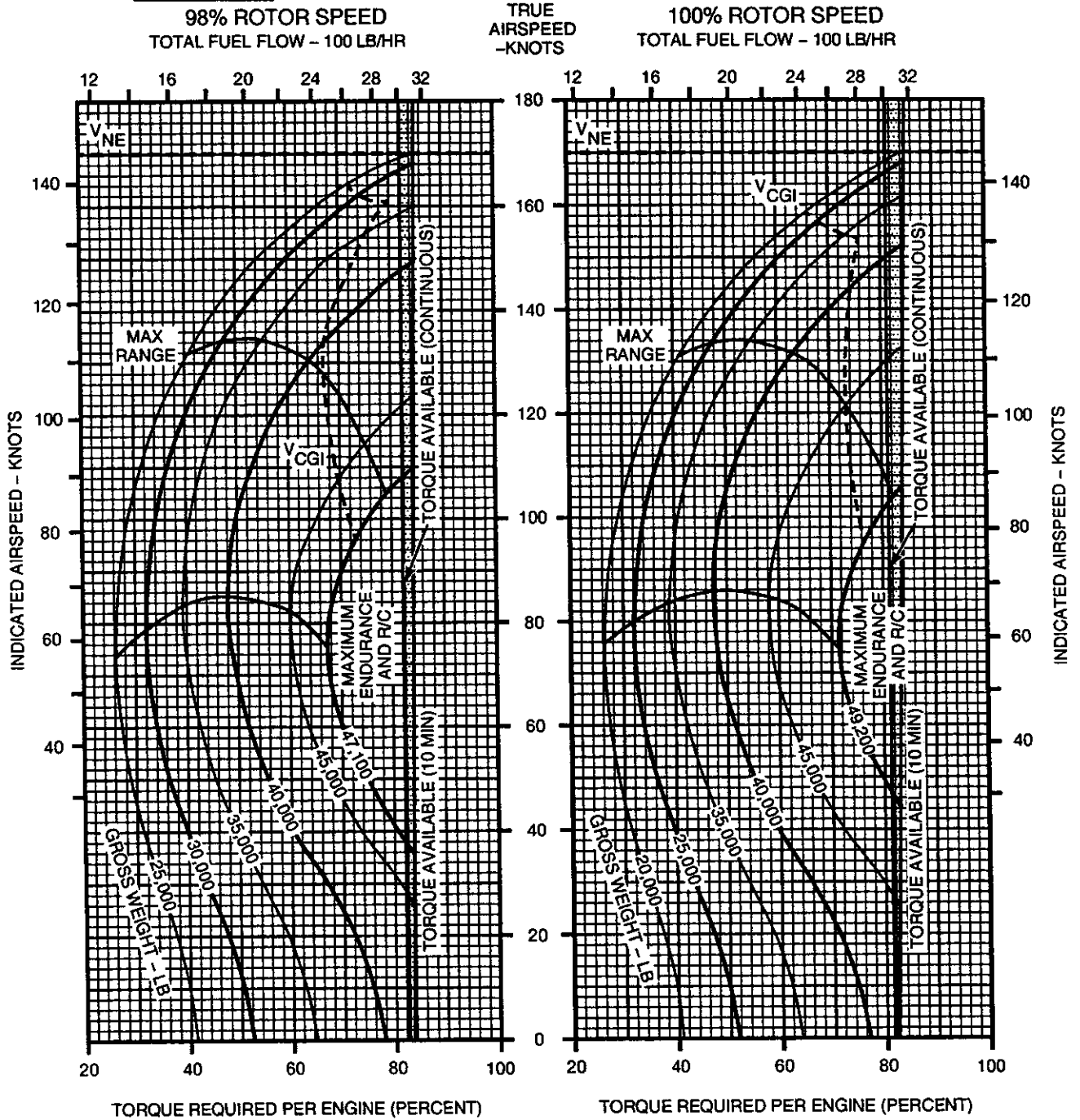
**PRESSURE ALTITUDE - 12000 FT**

**CRUISE  
CH-47D  
(2) T55-GA-714A**

**CLEAN CONFIGURATION**

**FAT = -20°C**

**FAT = -20°C**



DATA BASIS: FLIGHT TEST

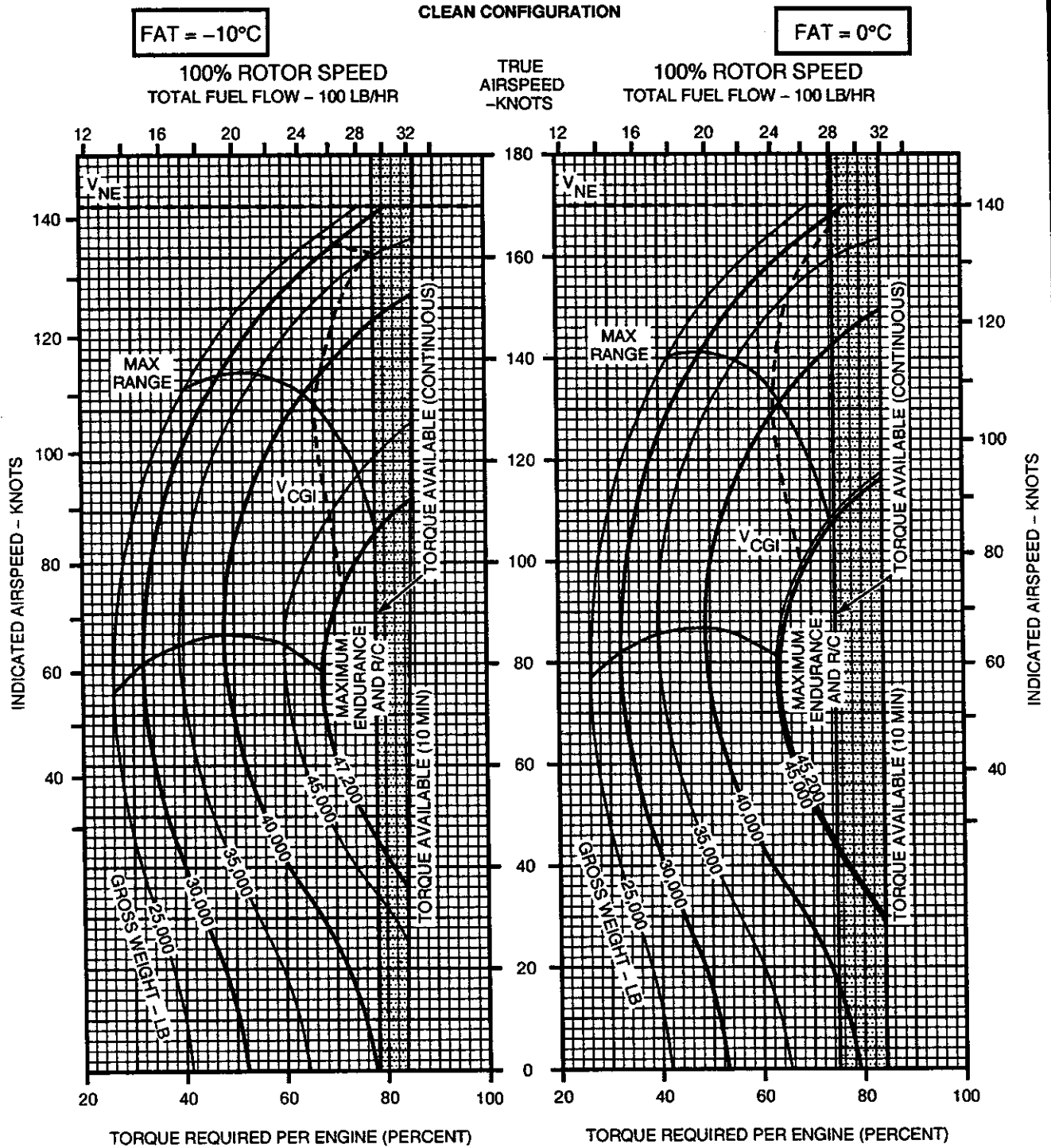
**Figure 7A-61. 98 and 100% Rotor RPM, -20°C, 12,000 Feet**

A60201

**CRUISE**

**PRESSURE ALTITUDE - 12000 FT**

**CRUISE  
CH-47D  
(2) T55-GA-714A**



DATA BASIS: FLIGHT TEST

A60202

Figure 7A-62. 100% Rotor RPM, -10° and 0°C, 12,000 Feet

**CRUISE**

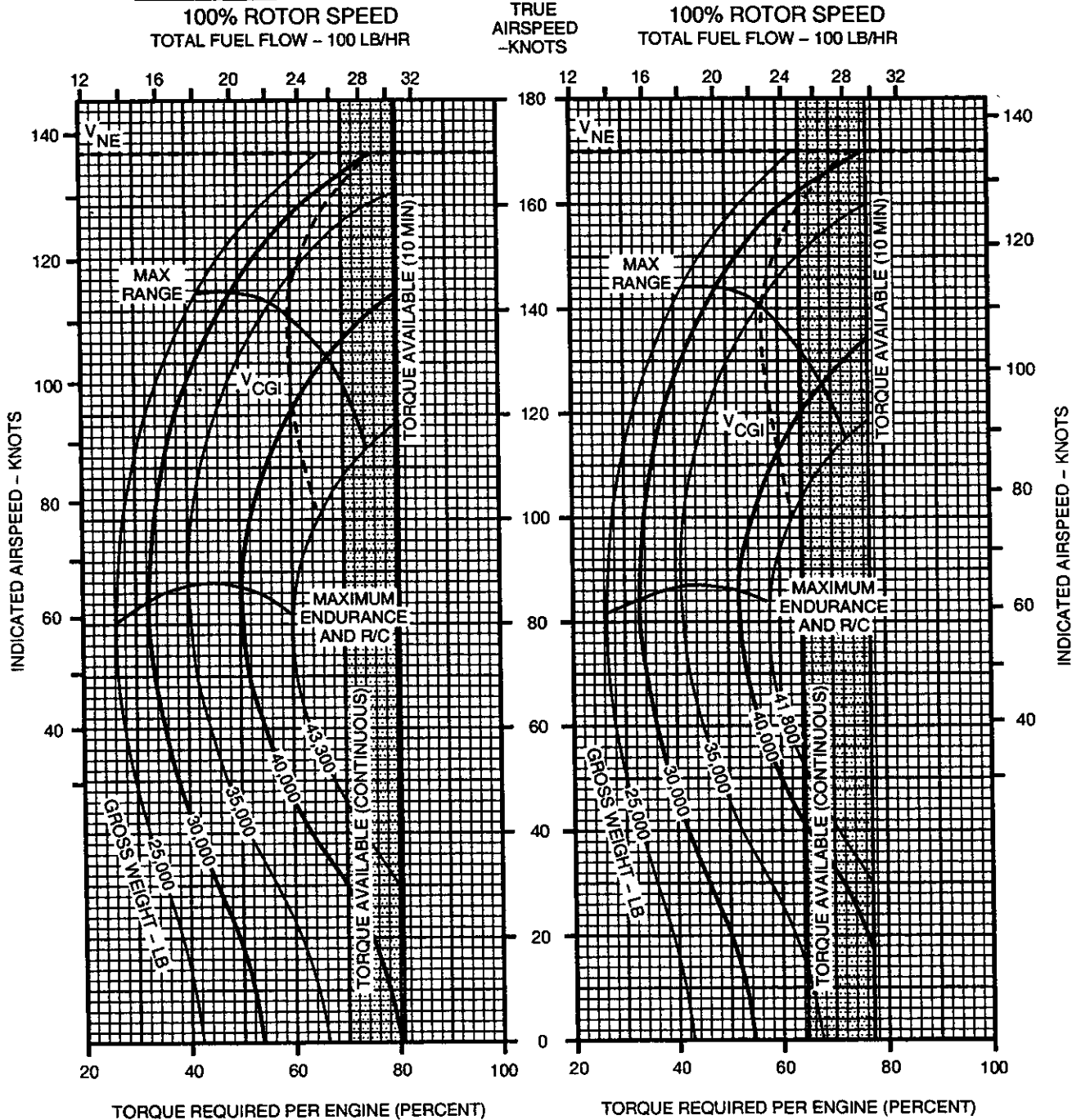
**PRESSURE ALTITUDE - 12000 FT**

**CRUISE  
CH-47D  
(2) T55-GA-714A**

**CLEAN CONFIGURATION**

**FAT = 10°C**

**FAT = 20°C**



DATA BASIS: FLIGHT TEST

**Figure 7A-63. 100% Rotor RPM, 10° and 20°C, 12,000 Feet**

A60203



**CRUISE**

**PRESSURE ALTITUDE - 12000 FT**

**CRUISE  
CH-47D  
(2) T55-GA-714A**

**CLEAN CONFIGURATION**

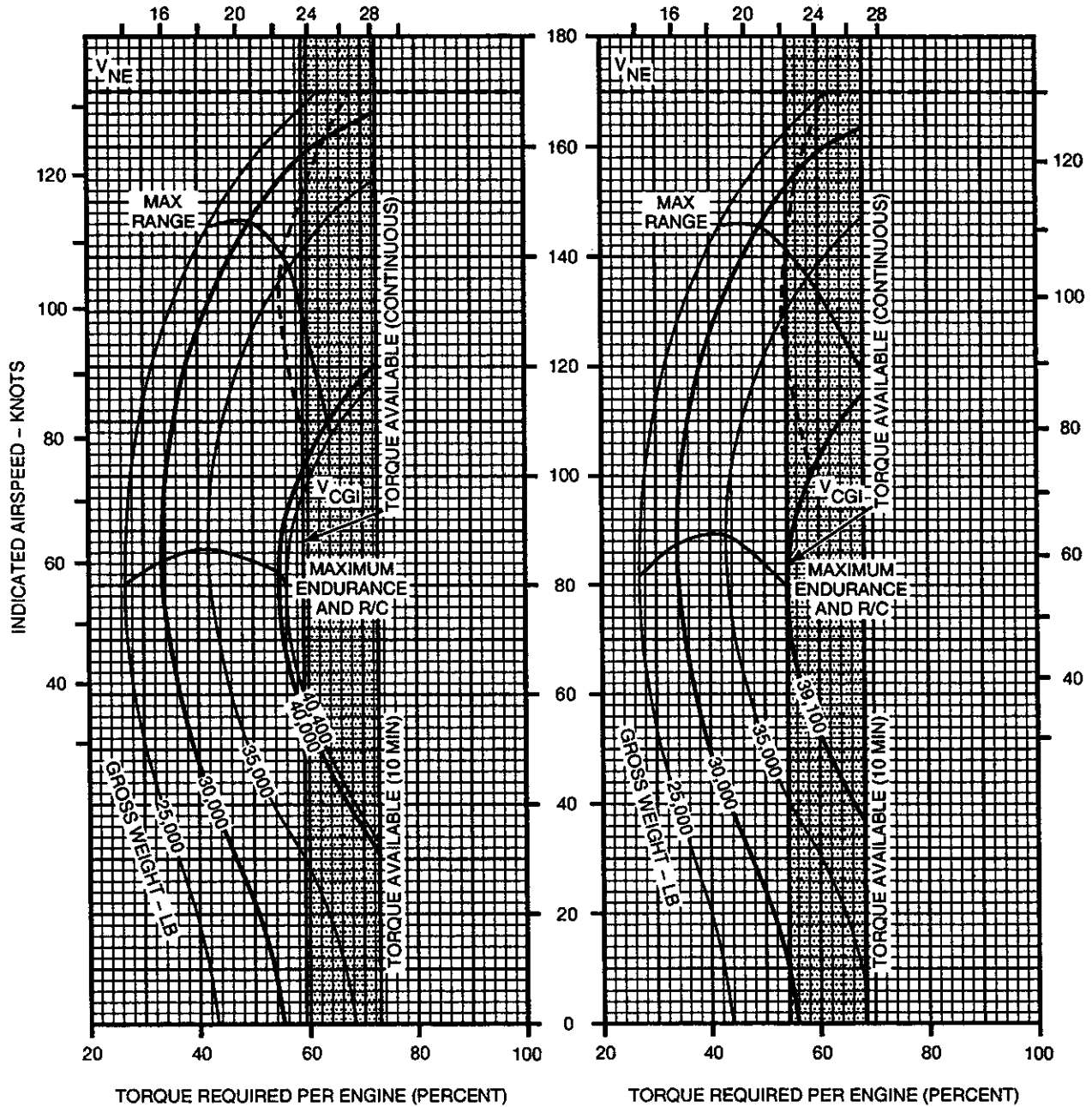
**FAT = 30°C**

**FAT = 40°C**

**100% ROTOR SPEED  
TOTAL FUEL FLOW - 100 LB/HR**

**TRUE  
AIRSPEED  
-KNOTS**

**100% ROTOR SPEED  
TOTAL FUEL FLOW - 100 LB/HR**



DATA BASIS: FLIGHT TEST

A60204

**Figure 7A-64. 100% Rotor PM, 30° and 40° C, 12,000 Feet**

**CRUISE**

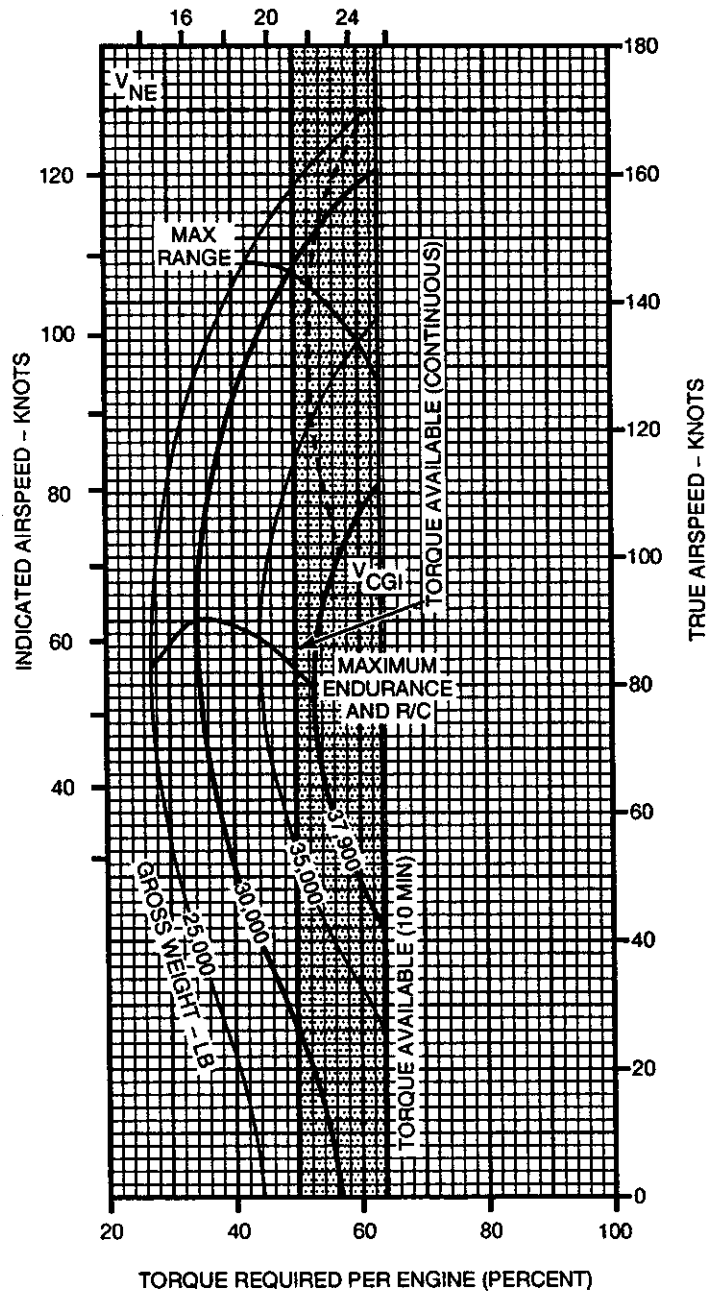
**PRESSURE ALTITUDE - 12000 FT**

**CRUISE  
CH-47D  
(2) T55-GA-714A**

**CLEAN CONFIGURATION**

**FAT = 50°C**

**100% ROTOR SPEED  
TOTAL FUEL FLOW - 100 LB/HR**



DATA BASIS: FLIGHT TEST

**Figure 7A-65. 100% Rotor RPM, 50°C, 12,000 Feet**

A60205

**CRUISE**

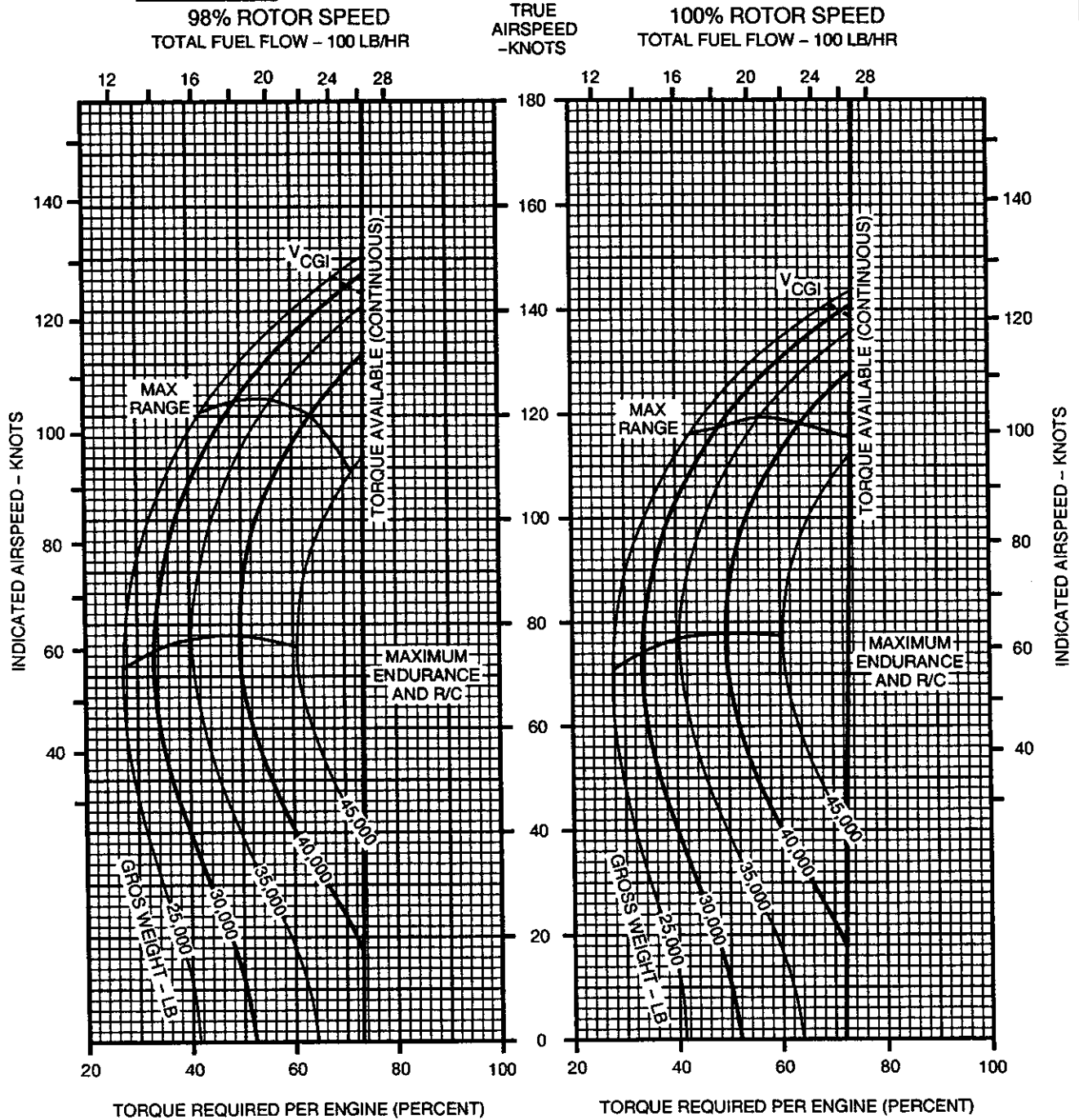
**PRESSURE ALTITUDE - 14000 FT**

**CRUISE  
CH-47D  
(2) T55-GA-714A**

**CLEAN CONFIGURATION**

**FAT = -50°C**

**FAT = -50°C**



DATA BASIS: FLIGHT TEST

A60206

Figure 7A-66. 98 and 100% Rotor RPM, -50°C, 14,000 Feet

**CRUISE**

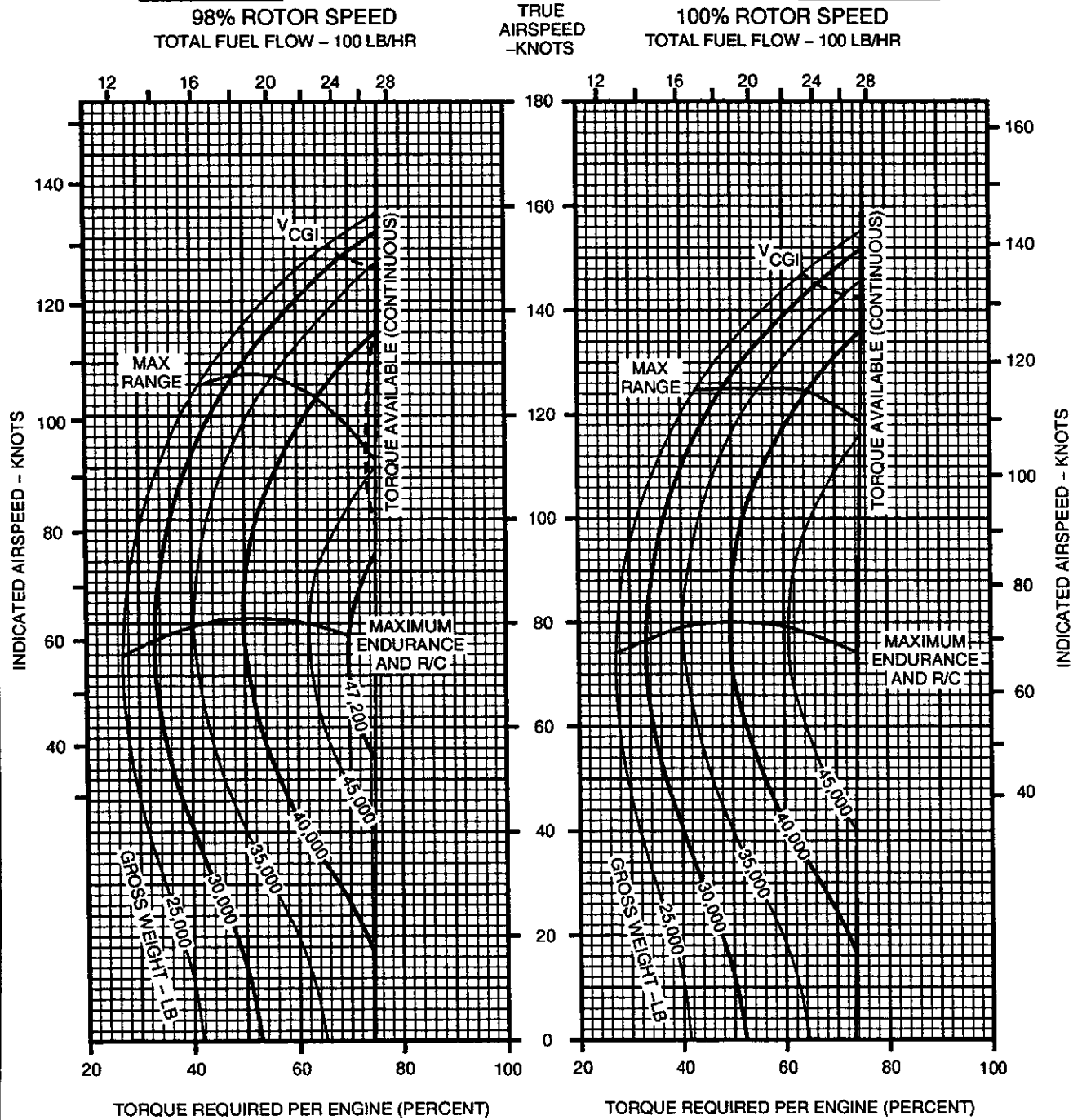
**PRESSURE ALTITUDE - 14000 FT**

**CRUISE  
CH-47D  
(2) T55-GA-714A**

**CLEAN CONFIGURATION**

**FAT = -40°C**

**FAT = -40°C**



DATA BASIS: FLIGHT TEST

**Figure 7A-67. 98 and 100% Rotor RPM, -40°C, 14,000 Feet**

A60207

**CRUISE**

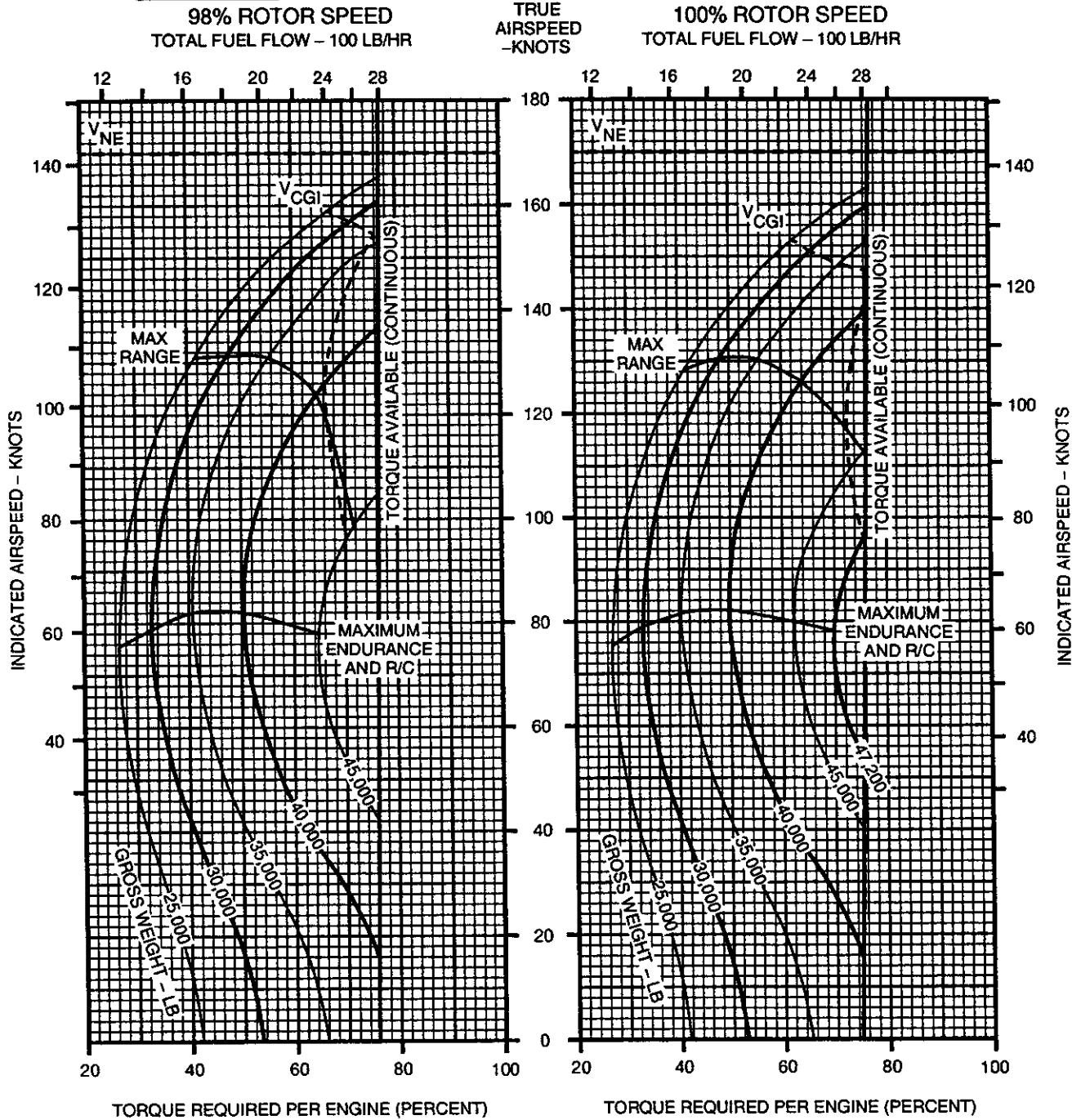
**PRESSURE ALTITUDE - 14000 FT**

**CRUISE  
CH-47D  
(2) T55-GA-714A**

**CLEAN CONFIGURATION**

**FAT = -30°C**

**FAT = -30°C**



DATA BASIS: FLIGHT TEST

A60208

**Figure 7A-68. 98 and 100% Rotor RPM, -30°C, 14,000 Feet**

**CRUISE**

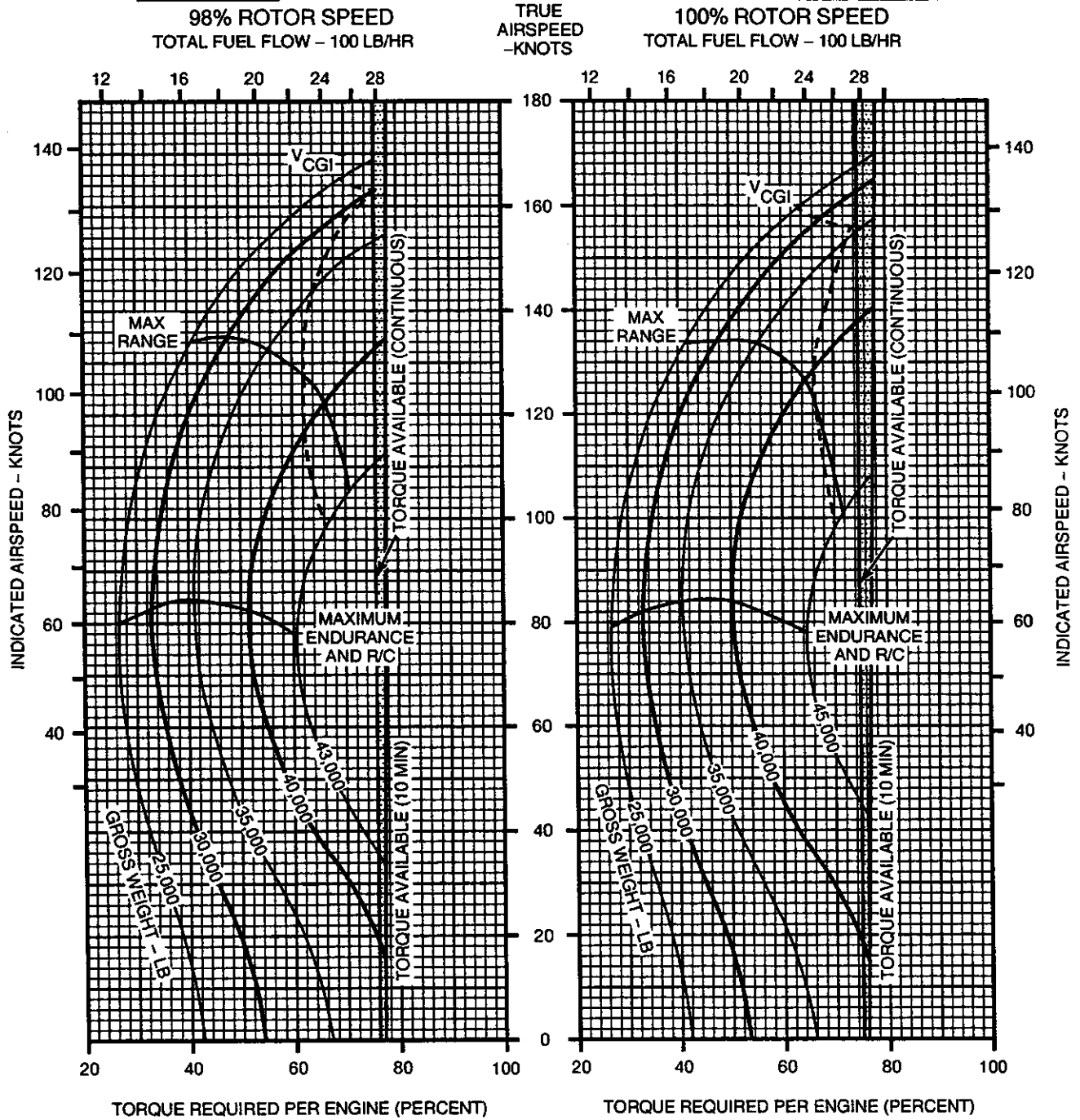
**PRESSURE ALTITUDE - 14000 FT**

**CRUISE  
CH-47D  
(2) T55-GA-714A**

**CLEAN CONFIGURATION**

**FAT = -20°C**

**FAT = -20°C**



DATA BASIS: FLIGHT TEST

**Figure 7A-69. 98 and 100% Rotor RPM, -20°C, 14,000 Feet**

A60209

**CRUISE**

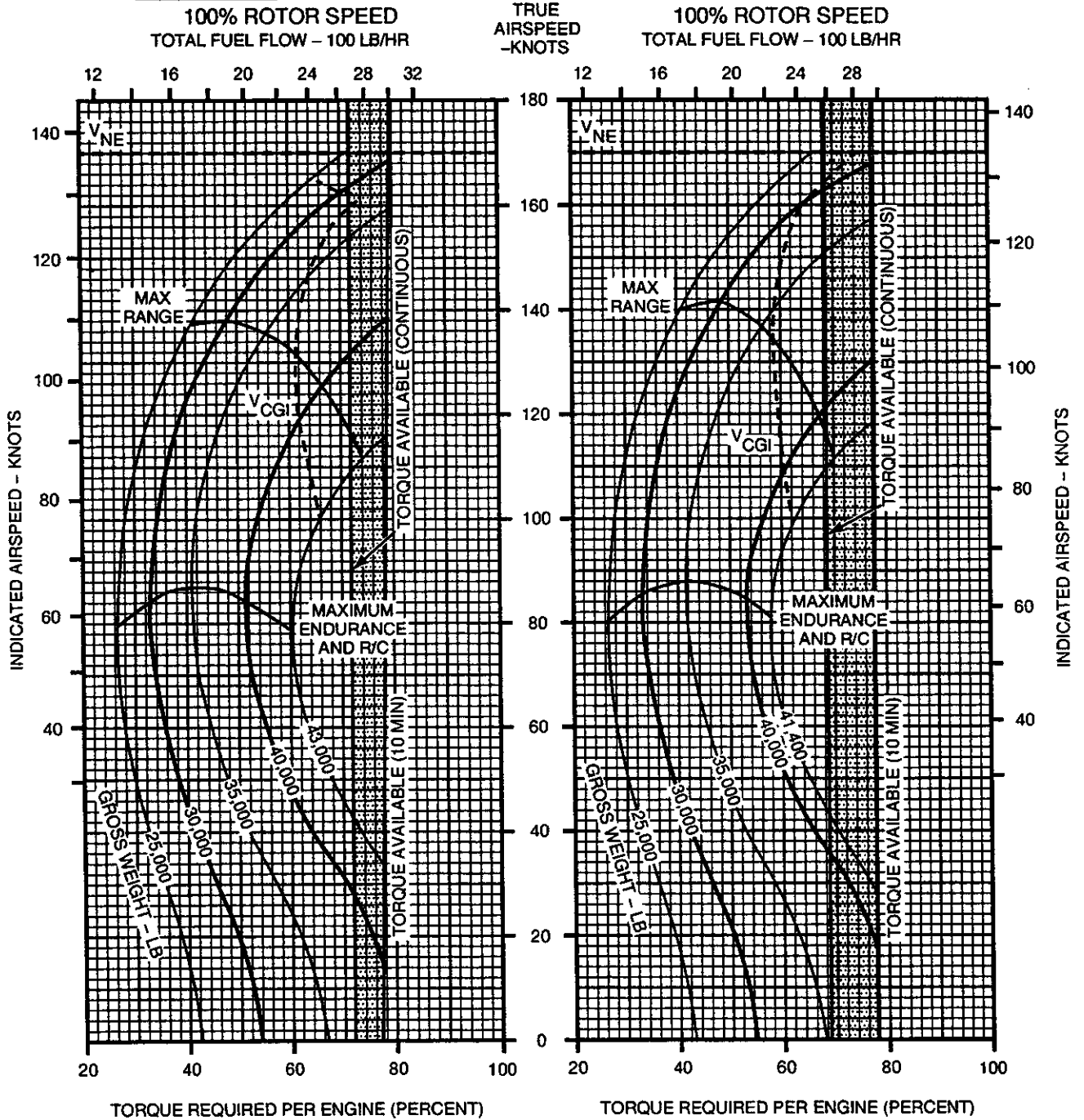
**PRESSURE ALTITUDE - 14000 FT**

**CRUISE  
CH-47D  
(2) T55-GA-714A**

**CLEAN CONFIGURATION**

**FAT = -10°C**

**FAT = 0°C**



DATA BASIS: FLIGHT TEST

A60210

Figure 7A-70. 100% Rotor RPM, -10° and 0°C, 14,000 Feet

**CRUISE**

**PRESSURE ALTITUDE - 14000 FT**

**CRUISE  
CH-47D  
(2) T55-GA-714A**

**CLEAN CONFIGURATION**

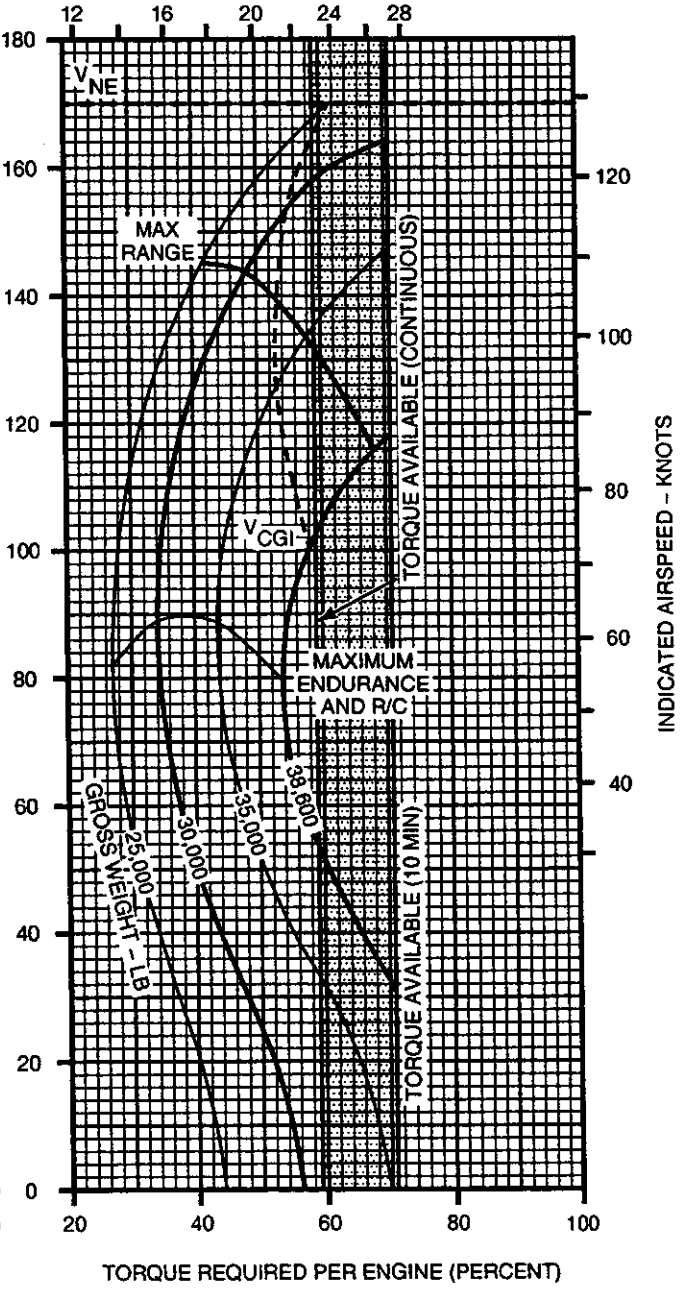
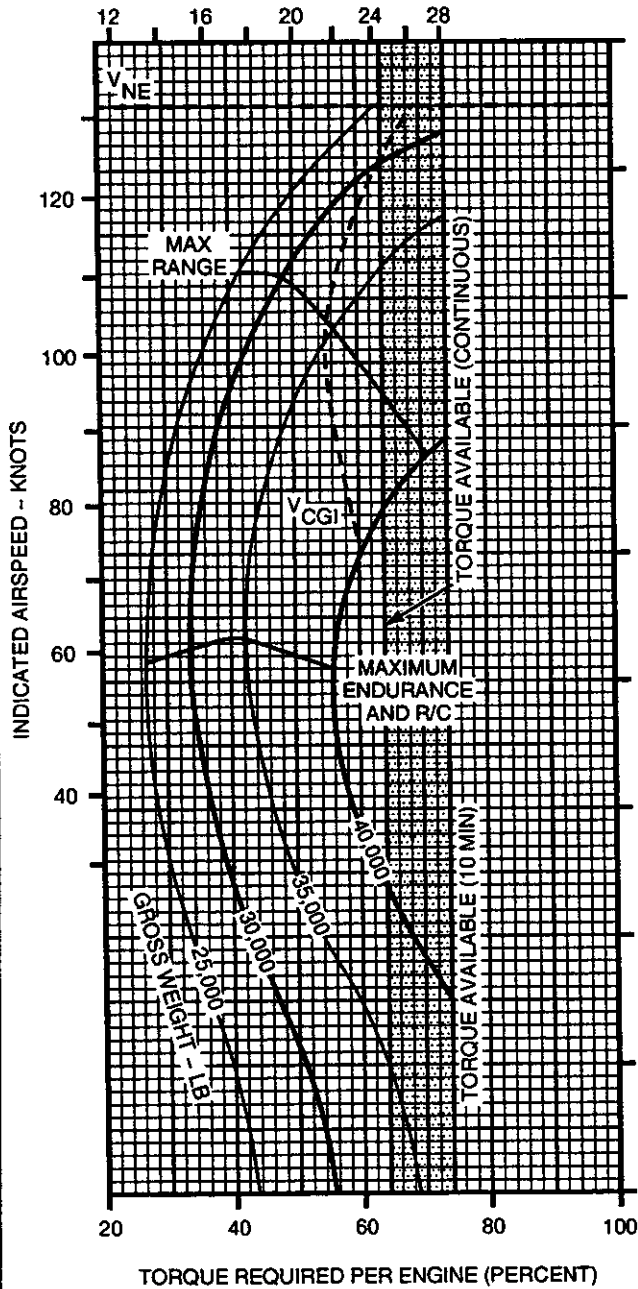
**FAT = 10°C**

**FAT = 20°C**

**100% ROTOR SPEED  
TOTAL FUEL FLOW - 100 LB/HR**

**TRUE  
AIRSPEED  
-KNOTS**

**100% ROTOR SPEED  
TOTAL FUEL FLOW - 100 LB/HR**



DATA BASIS: FLIGHT TEST

**Figure 7A-71. 100% Rotor RPM, 10° and 20° C, 14,000 Feet**

A60211

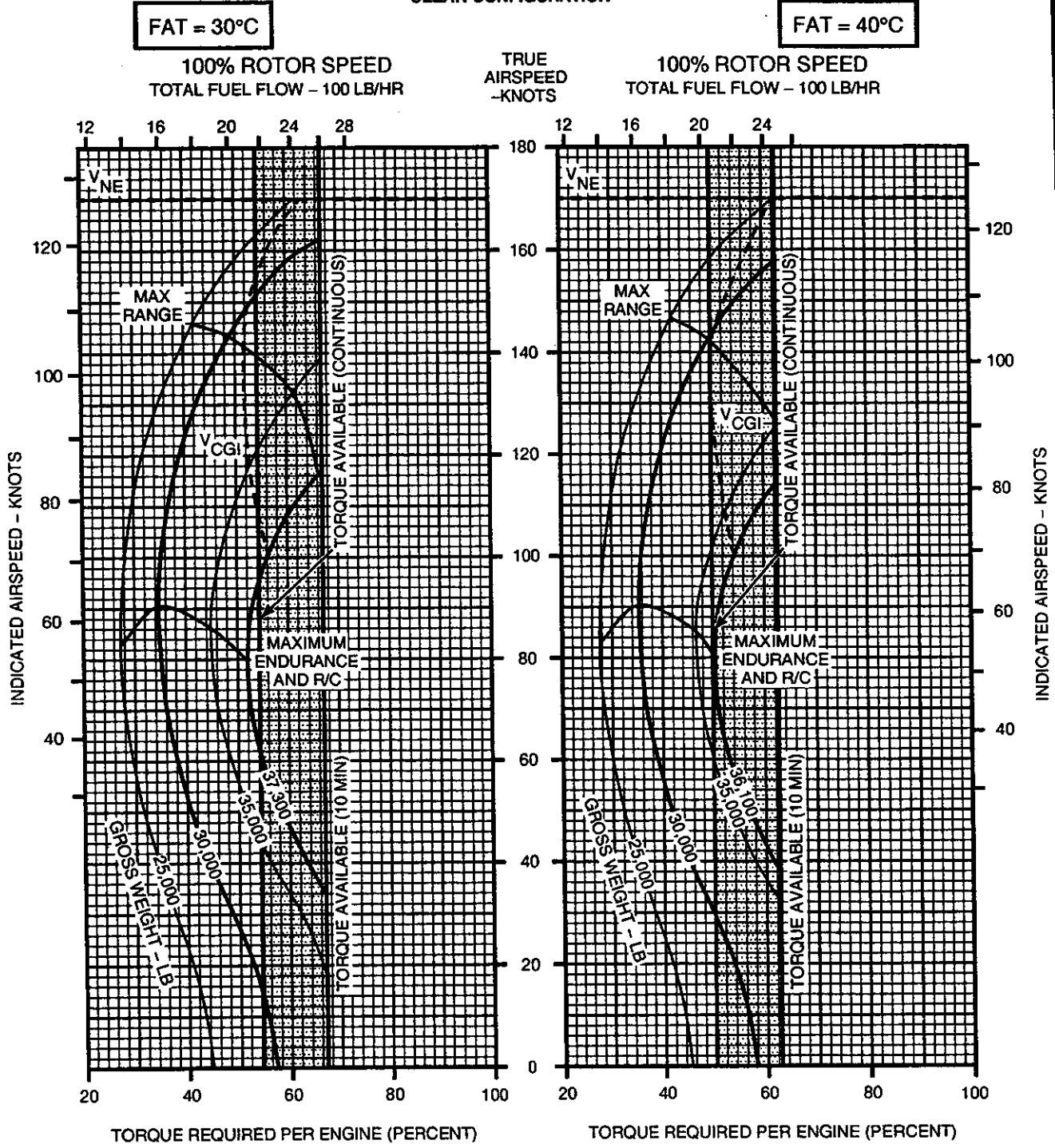


**CRUISE**

**PRESSURE ALTITUDE - 14000 FT**

**CRUISE  
CH-47D  
(2) T55-GA-714A**

**CLEAN CONFIGURATION**



DATA BASIS: FLIGHT TEST

A60212

**Figure 7A-72. 100% Rotor RPM, 30° and 40°C, 14,000 Feet**

# CRUISE

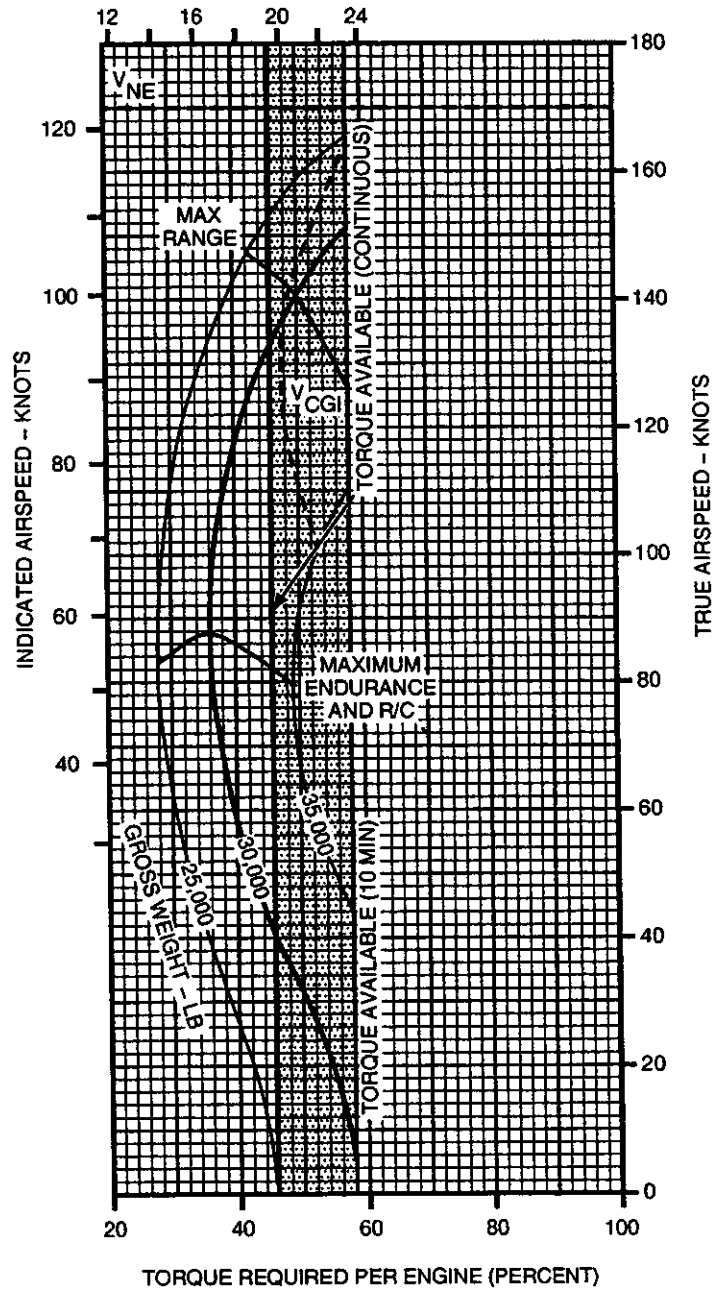
PRESSURE ALTITUDE - 14000 FT

CRUISE  
CH-47D  
(2) T55-GA-714A

CLEAN CONFIGURATION

FAT= 50°C

100% ROTOR SPEED  
TOTAL FUEL FLOW - 100 LB/HR



DATA BASIS: FLIGHT TEST

Figure 7A-73. 100% Rotor RPM, 50°C, 14,000 Feet

A60213

**CRUISE**

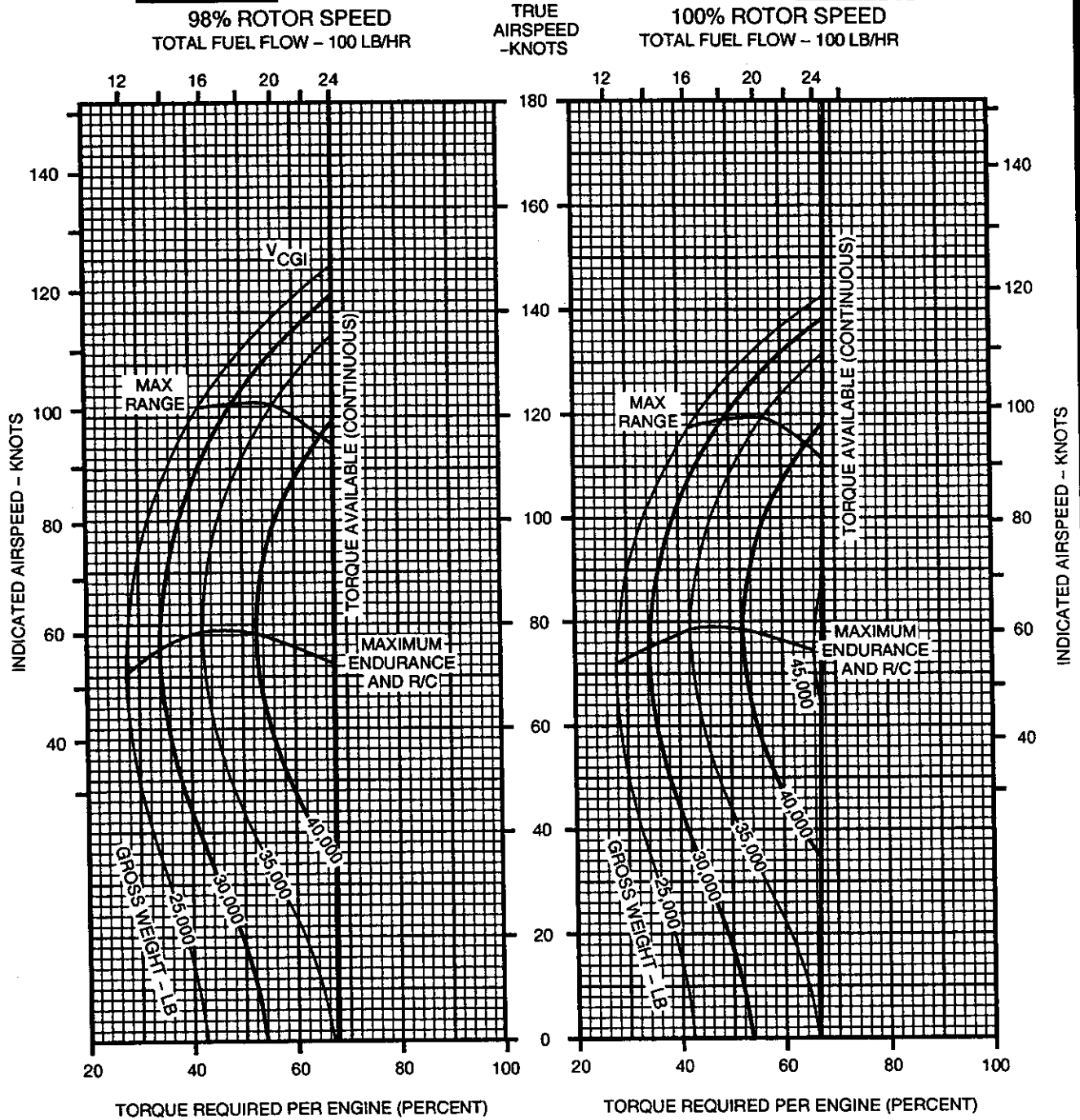
**PRESSURE ALTITUDE - 16000 FT**

**CRUISE  
CH-47D  
(2) T55-GA-714A**

**CLEAN CONFIGURATION**

**FAT = -50°C**

**FAT = -50°C**



DATA BASIS: FLIGHT TEST

A60214

**Figure 7A-74. 98 and 100% Rotor RPM, -50°C, 16,000 Feet**

**CRUISE**

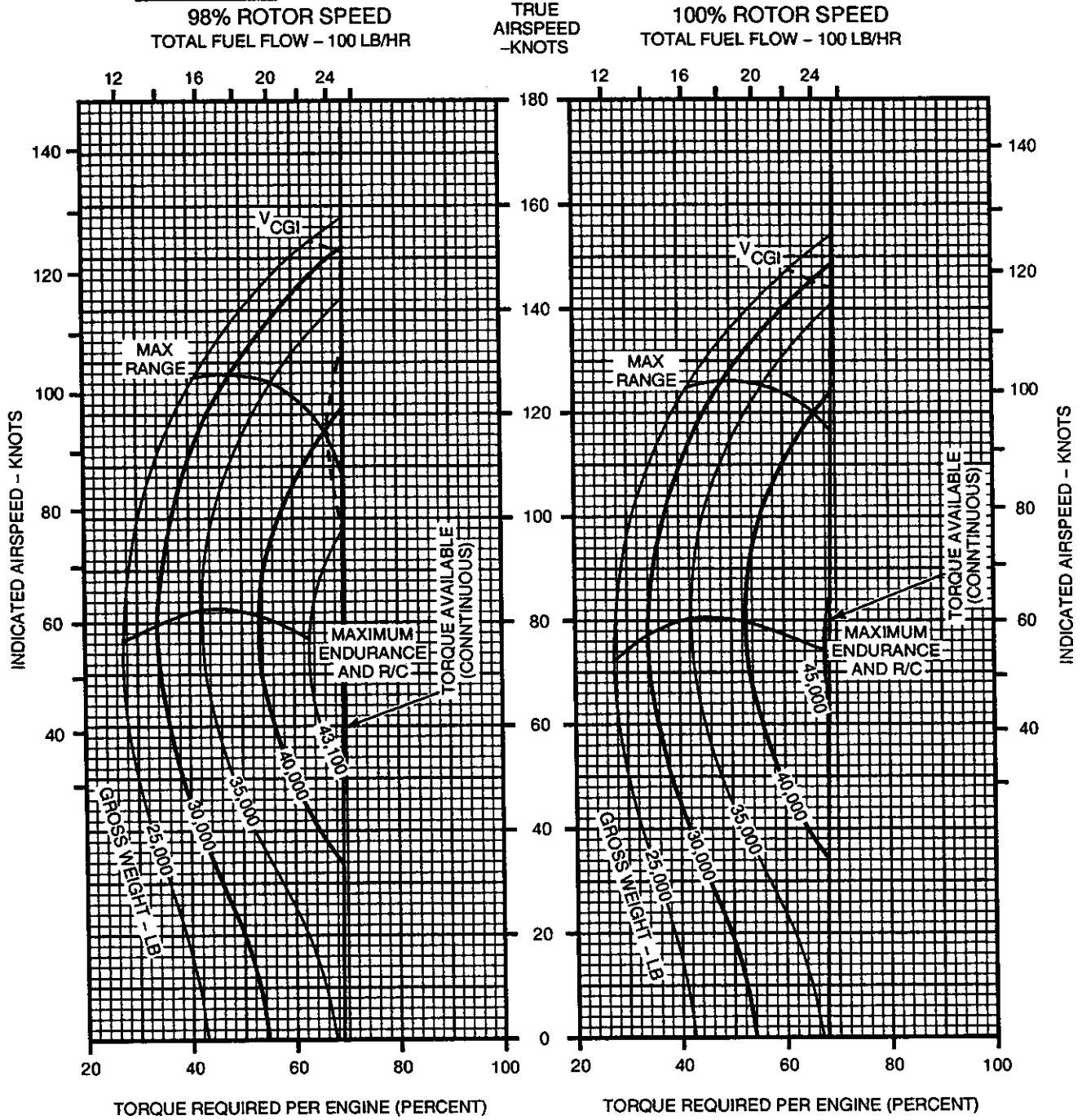
**PRESSURE ALTITUDE - 16000 FT**

**CRUISE  
CH-47D  
(2) T55-GA-714A**

**CLEAN CONFIGURATION**

**FAT = -40°C**

**FAT = -40°C**



DATA BASIS: FLIGHT TEST

**Figure 7A-75. 98 and 100% Rotor RPM, -40°C, 16,000 Feet**

A60215

**CRUISE**

**PRESSURE ALTITUDE - 16000 FT**

**CRUISE  
CH-47D  
(2) T55-GA-714A**

**CLEAN CONFIGURATION**

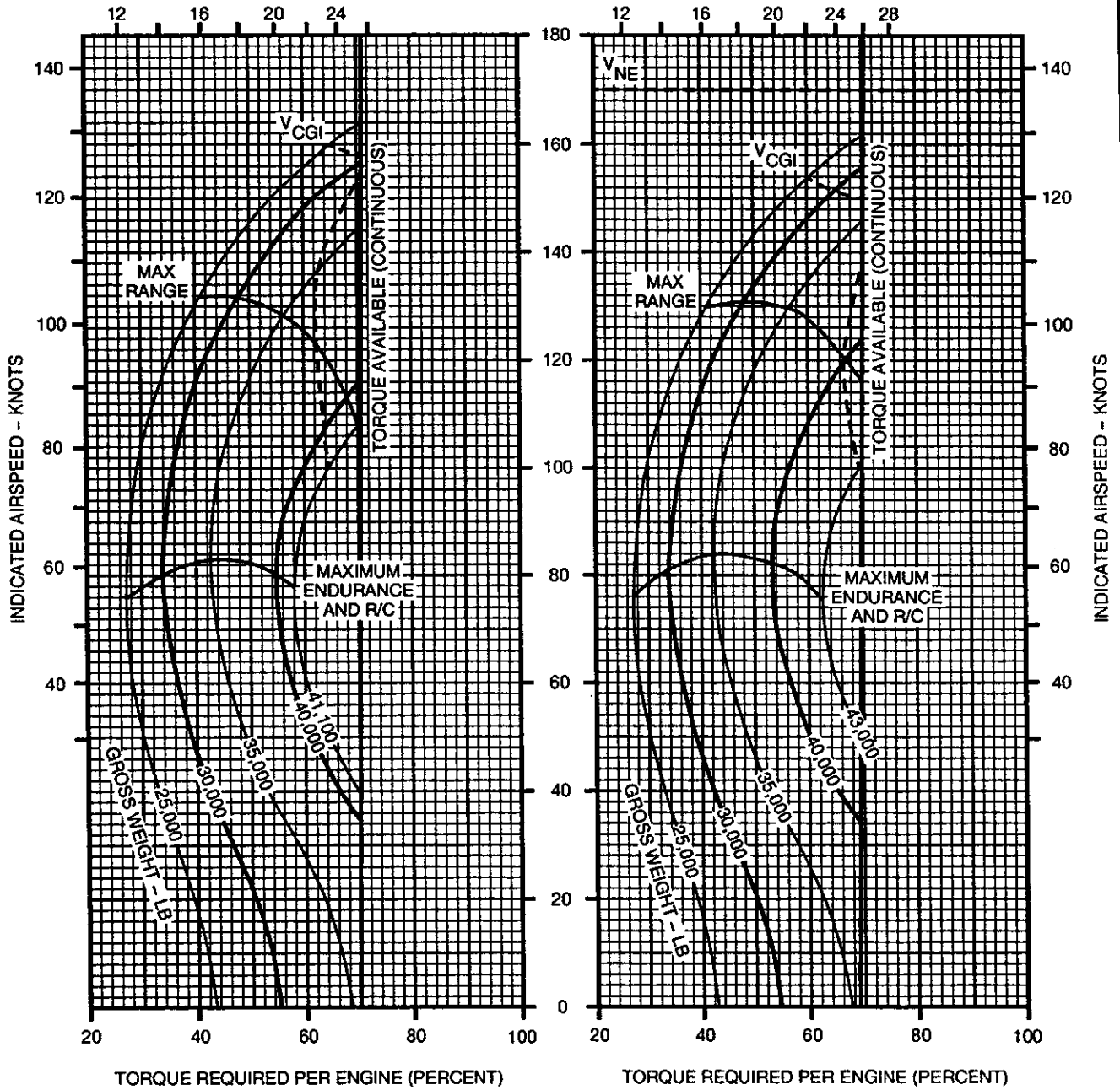
**FAT = -30°C**

**FAT = -30°C**

**98% ROTOR SPEED  
TOTAL FUEL FLOW - 100 LB/HR**

**TRUE  
AIRSPEED  
-KNOTS**

**100% ROTOR SPEED  
TOTAL FUEL FLOW - 100 LB/HR**



DATA BASIS: FLIGHT TEST

A60216

Figure 7A-76. 98 and 100% Rotor RPM, -30°C, 16,000 Feet

**CRUISE**

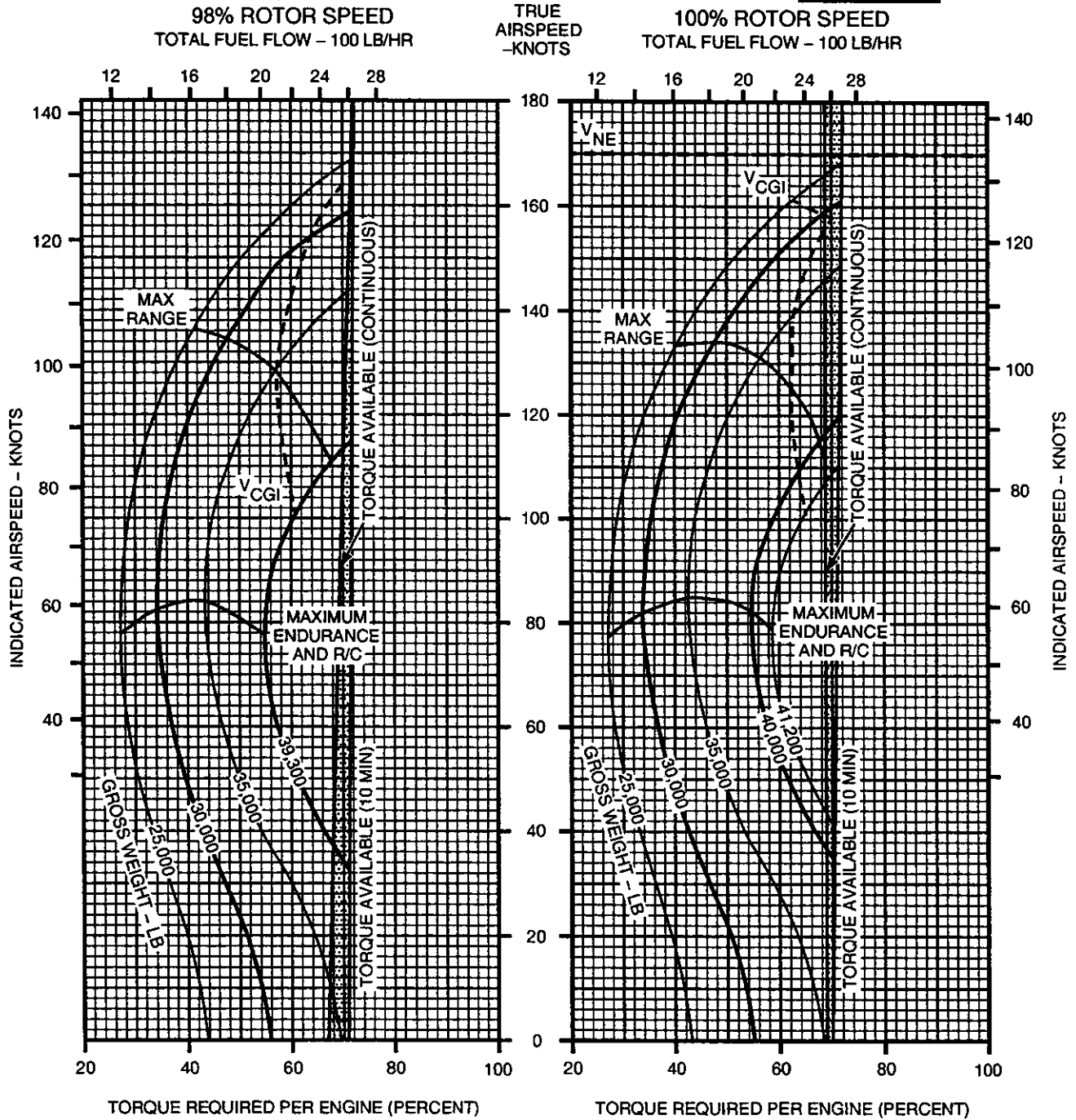
**PRESSURE ALTITUDE - 16000 FT**

**CRUISE  
CH-47D  
(2) T55-GA-714A**

**CLEAN CONFIGURATION**

**FAT = -20°C**

**FAT = -20°C**



DATA BASIS: FLIGHT TEST

**Figure 7A-77. 98 and 100% Rotor RPM, -20°C, 16,000 Feet**

A60217

**CRUISE**

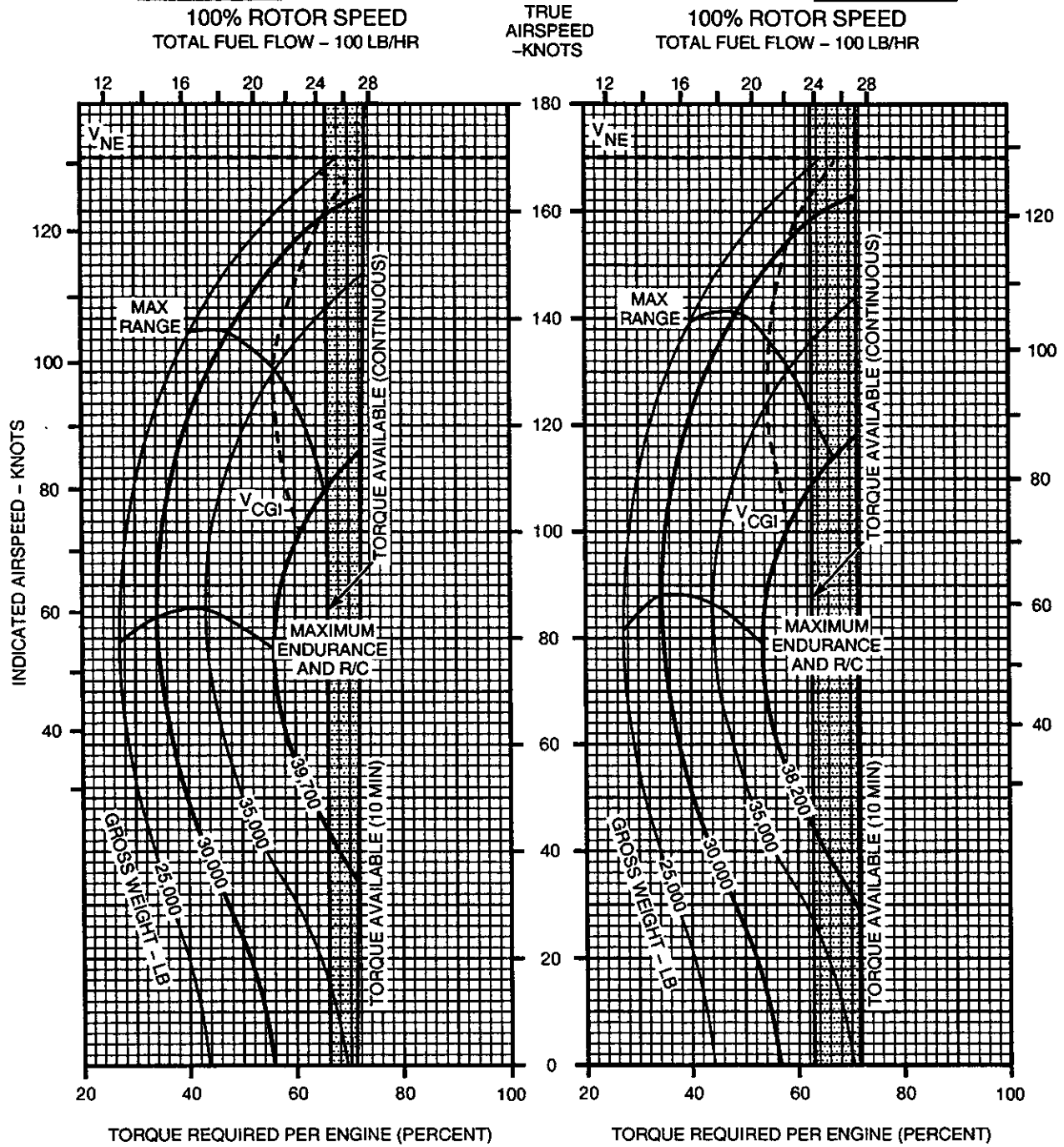
**PRESSURE ALTITUDE - 16000 FT**

**CRUISE  
CH-47D  
(2) T55-GA-714A**

**CLEAN CONFIGURATION**

**FAT = -10°C**

**FAT = 0°C**



DATA BASIS: FLIGHT TEST

A60218

**Figure 7A-78. 100% Rotor RPM, -10° and 0° C, 16,000 Feet**

**CRUISE**

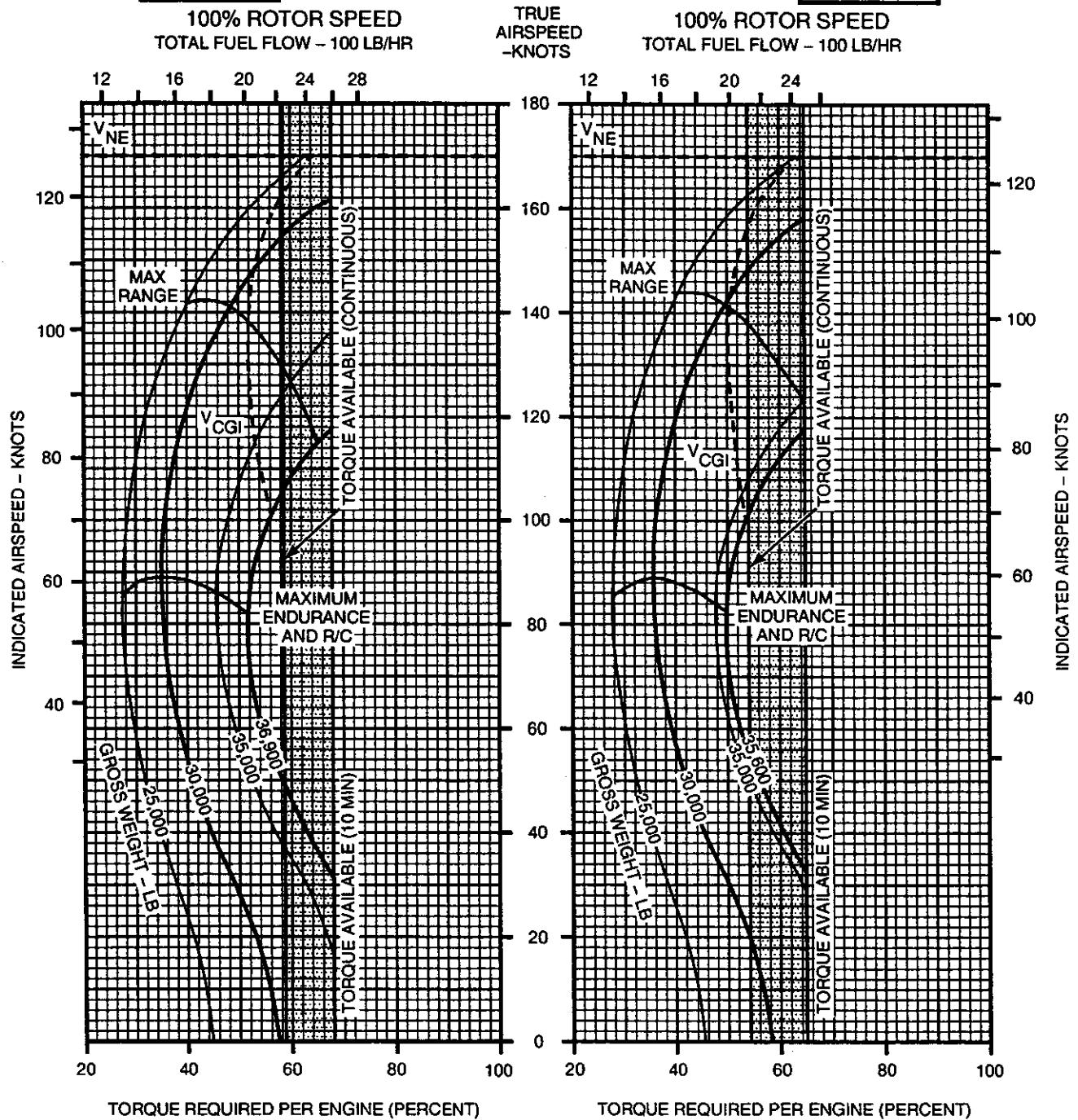
**PRESSURE ALTITUDE - 16000 FT**

**CRUISE  
CH-47D  
(2) T55-GA-714A**

**CLEAN CONFIGURATION**

**FAT = 10°C**

**FAT = 20°C**



DATA BASIS: FLIGHT TEST

**Figure 7A-79. 100% Rotor RPM, 10° and 20° C, 16,000 Feet**

A60219



**CRUISE**

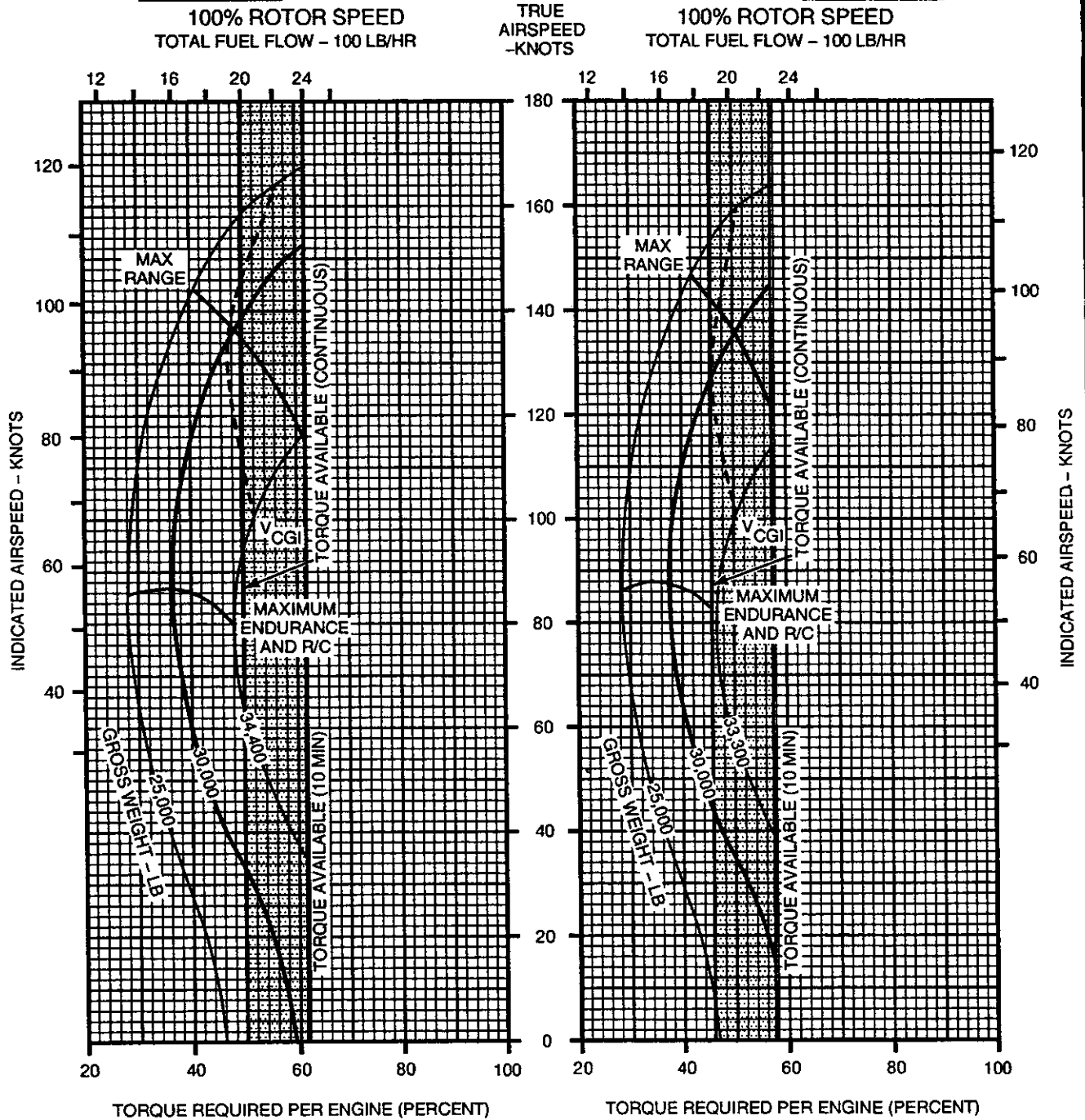
**PRESSURE ALTITUDE - 16000 FT**

**CRUISE  
CH-47D  
(2) T55-GA-714A**

**CLEAN CONFIGURATION**

**FAT = 30°C**

**FAT = 40°C**



DATA BASIS: FLIGHT TEST

A60220

**Figure 7A-80. 100% Rotor RPM, 30° and 40°C, 16,000 Feet**

**CRUISE**

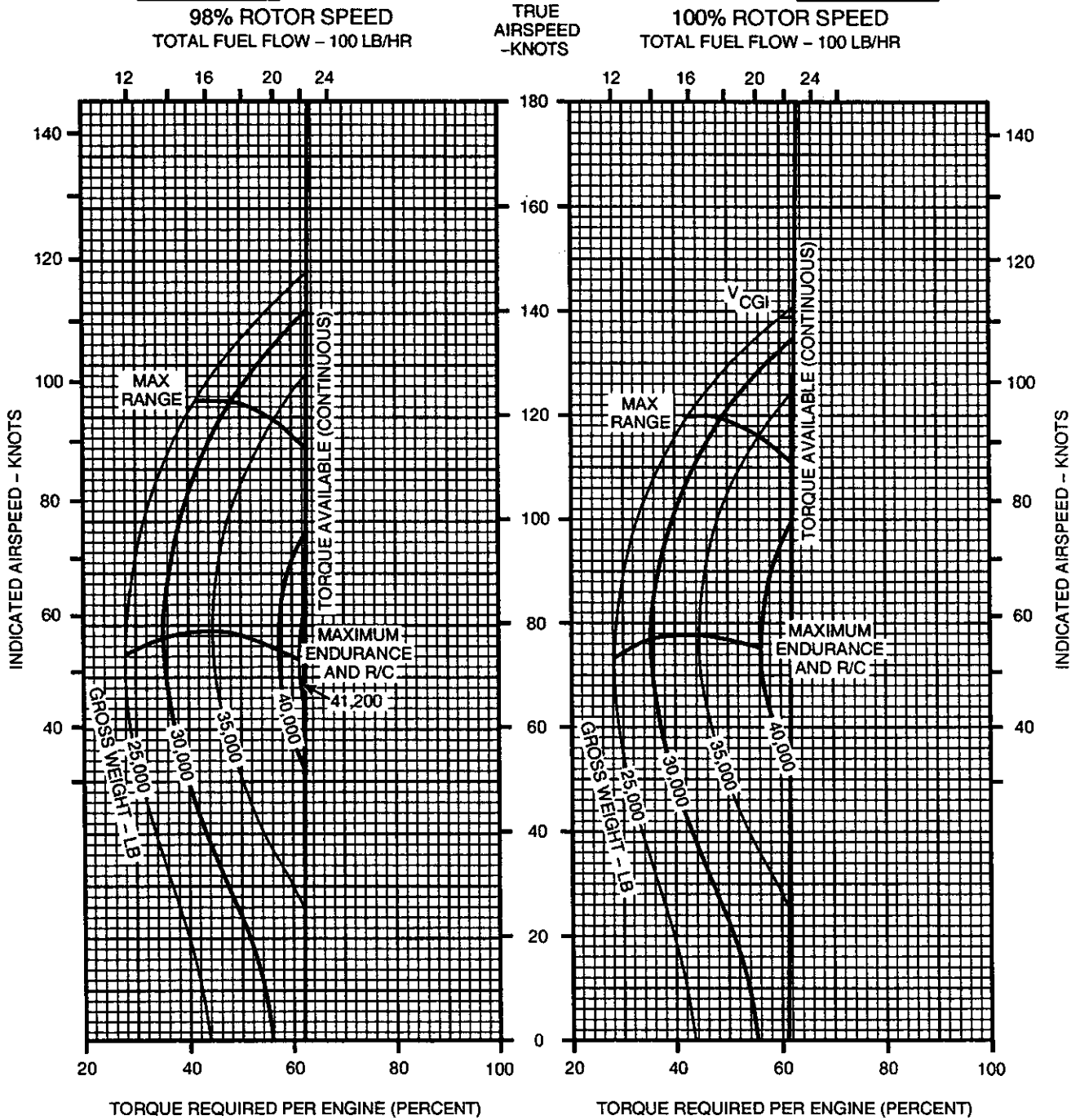
**PRESSURE ALTITUDE - 18000 FT**

**CRUISE  
CH-47D  
(2) T55-GA-714A**

**CLEAN CONFIGURATION**

**FAT = -50°C**

**FAT = -50°C**



DATA BASIS: FLIGHT TEST

**Figure 7A-81. 98 and 100% Rotor RPM, -50°C, 18,000 Feet**

A60221

**CRUISE**

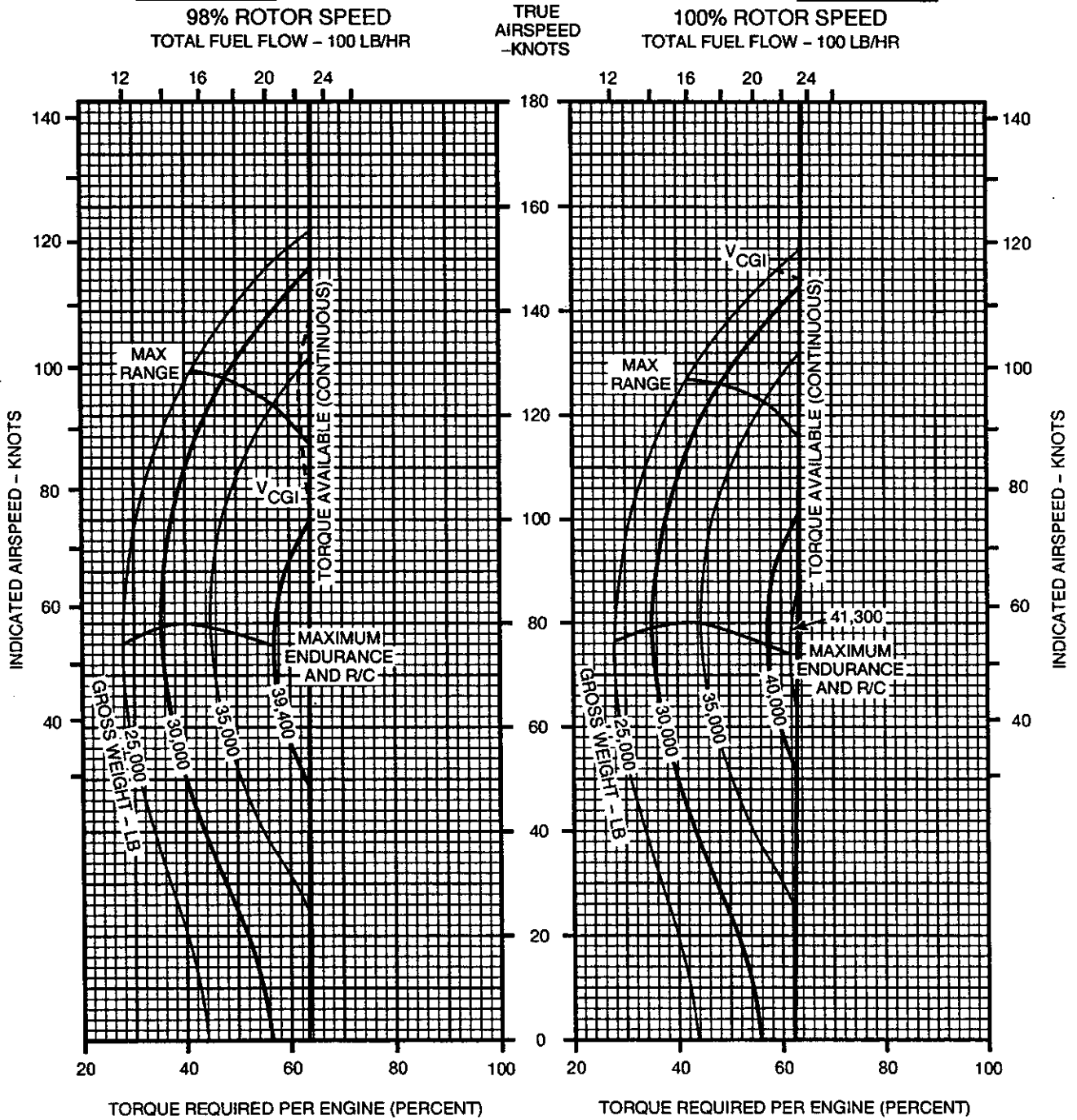
**PRESSURE ALTITUDE - 18000 FT**

**CRUISE  
CH-47D  
(2) T55-GA-714A**

**CLEAN CONFIGURATION**

**FAT = -40°C**

**FAT = -40°C**



DATA BASIS: FLIGHT TEST

A60222

**Figure 7A-82. 98 and 100% Rotor RPM, -40°C, 18,000 Feet**

**CRUISE**

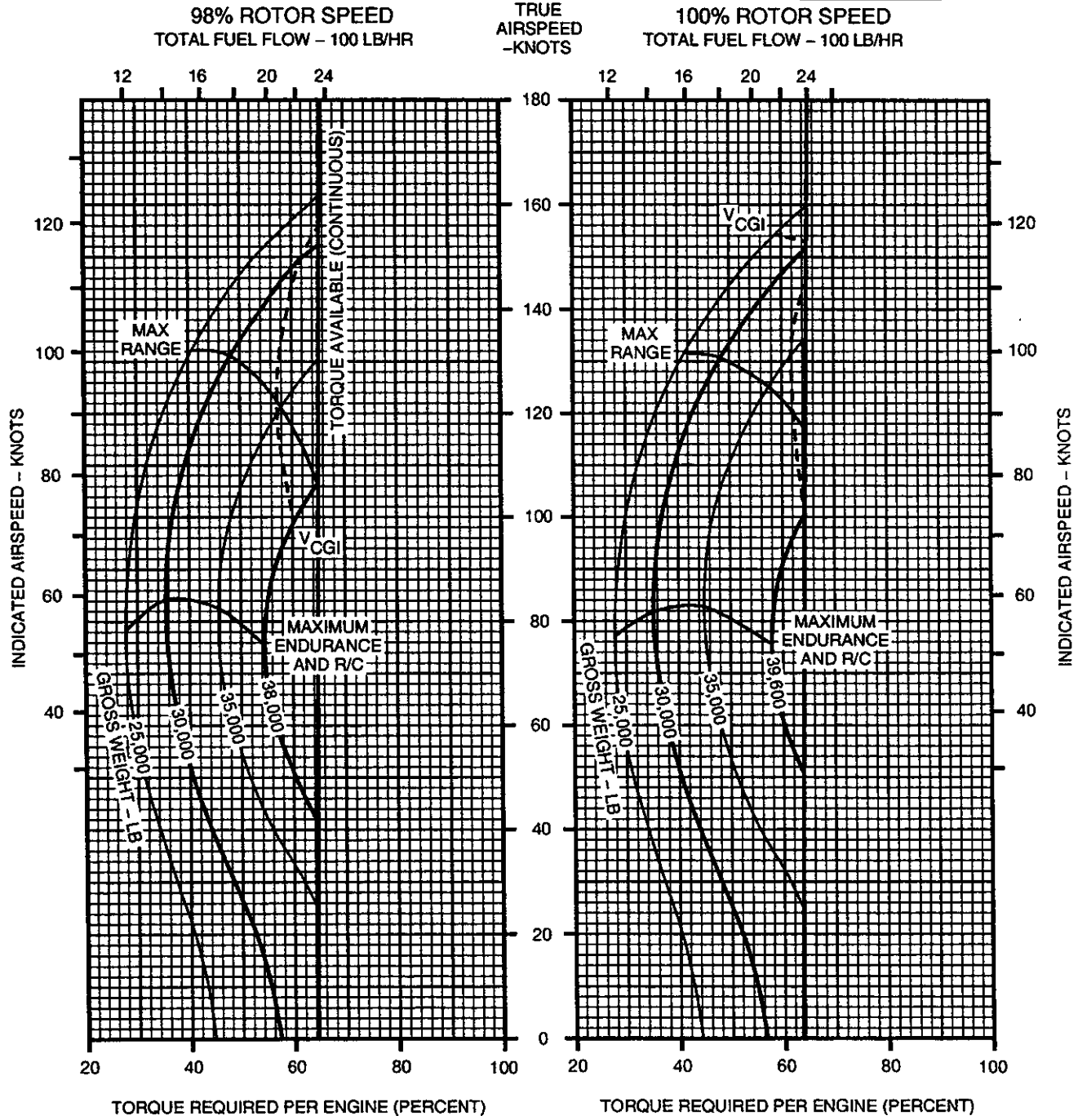
**PRESSURE ALTITUDE - 18000 FT**

**CRUISE  
CH-47D  
(2) T55-GA-714A**

**CLEAN CONFIGURATION**

**FAT = -30°C**

**FAT = -30°C**



DATA BASIS: FLIGHT TEST

A60223

**Figure 7A-83. 98 and 100% Rotor RPM, -30°C, 18,000 Feet**

**CRUISE**

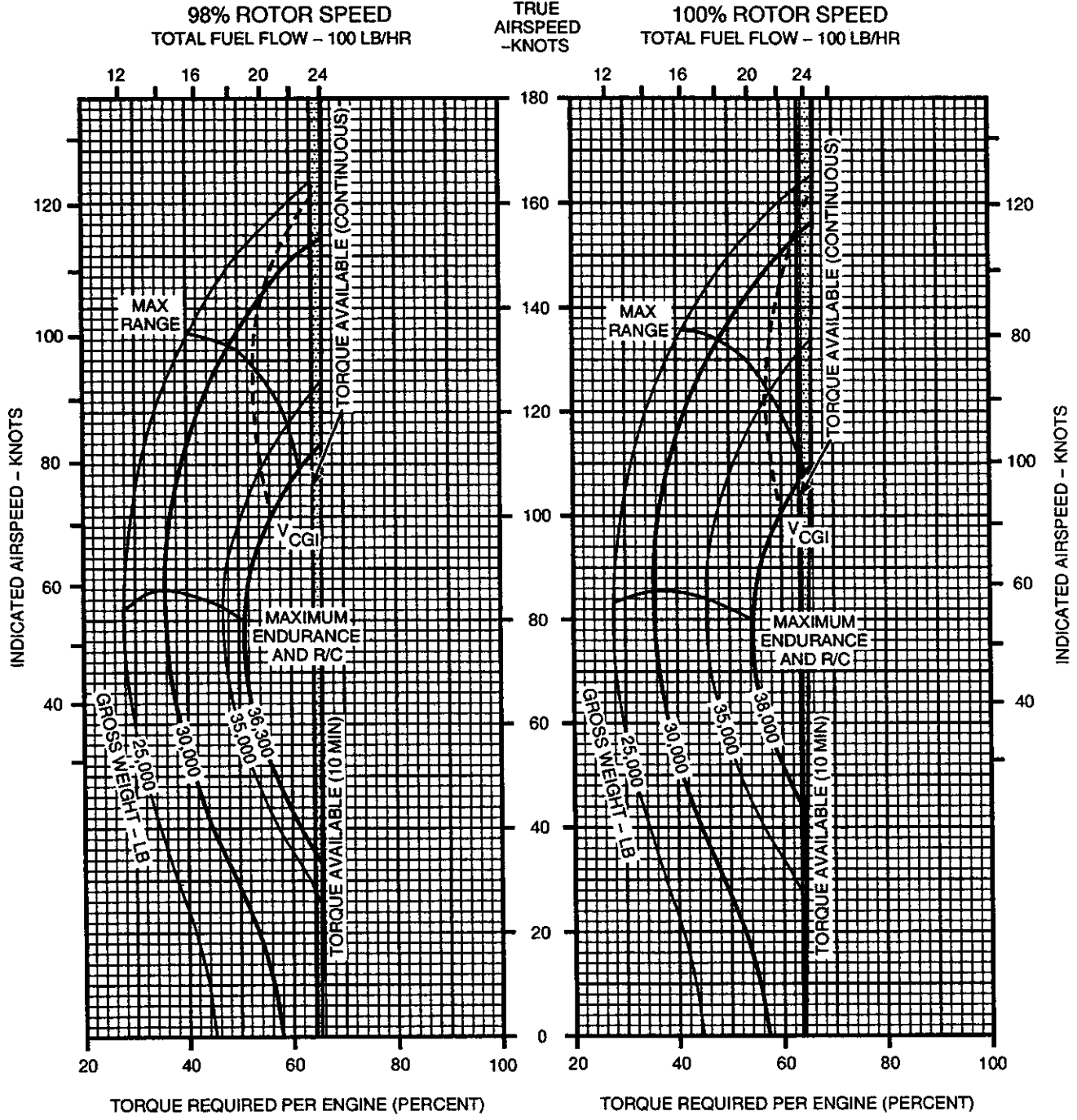
**PRESSURE ALTITUDE - 18000 FT**

**CRUISE  
CH-47D  
(2) T55-GA-714A**

**CLEAN CONFIGURATION**

**FAT = -20°C**

**FAT = -20°C**



DATA BASIS: FLIGHT TEST

A60224

**Figure 7A-84. 98 and 100% Rotor RPM, -20°C, 18,000 Feet**

CRUISE

PRESSURE ALTITUDE - 18000 FT

CRUISE  
CH-47D  
(2) T55-GA-714A

CLEAN CONFIGURATION

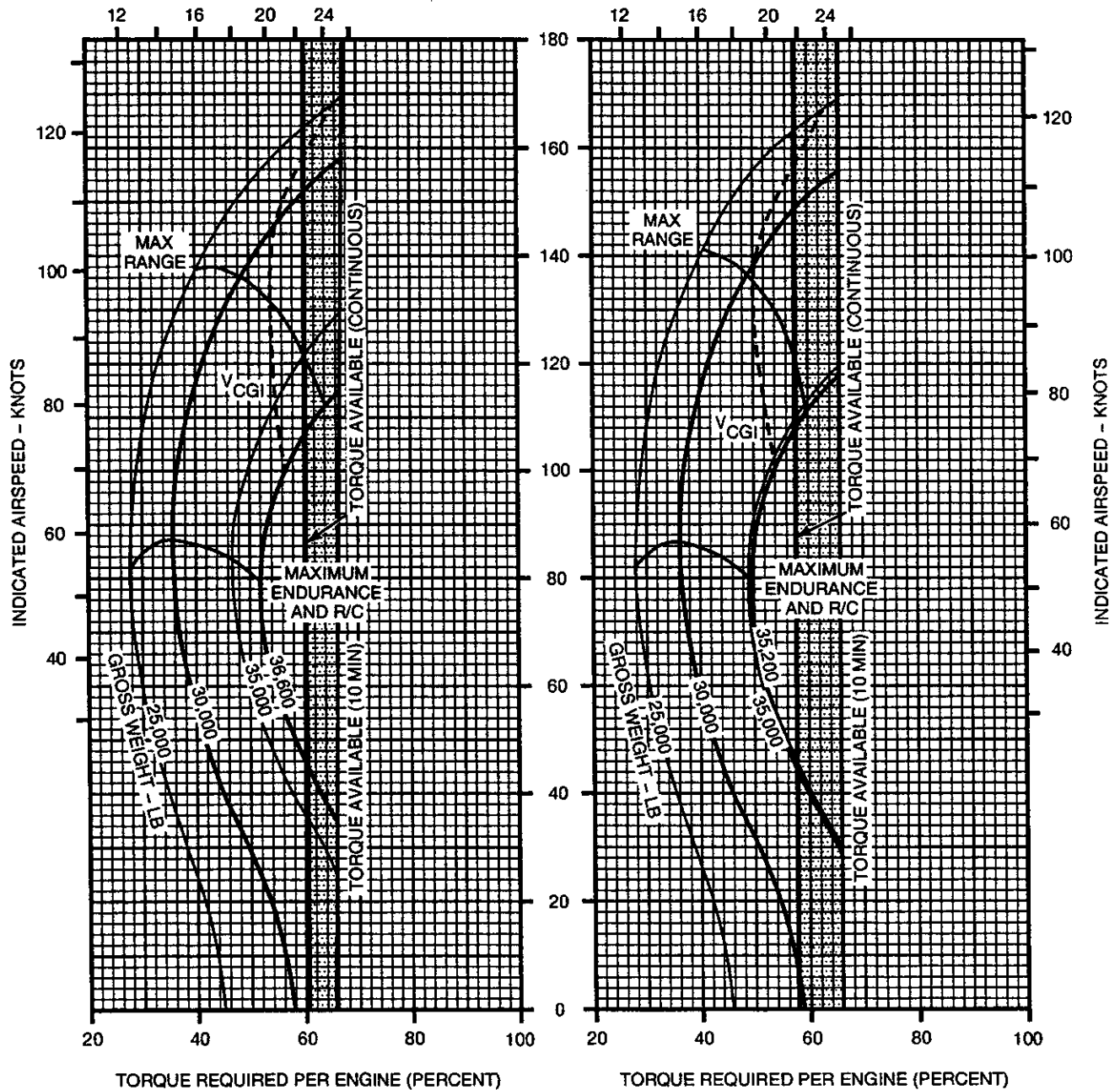
FAT = -10°C

FAT = 0°C

100% ROTOR SPEED  
TOTAL FUEL FLOW - 100 LB/HR

TRUE  
AIRSPEED  
-KNOTS

100% ROTOR SPEED  
TOTAL FUEL FLOW - 100 LB/HR



DATA BASIS: FLIGHT TEST

Figure 7A-85. 100% Rotor RPM, -10° and 0° C, 18,000 Feet

A60225

**CRUISE**

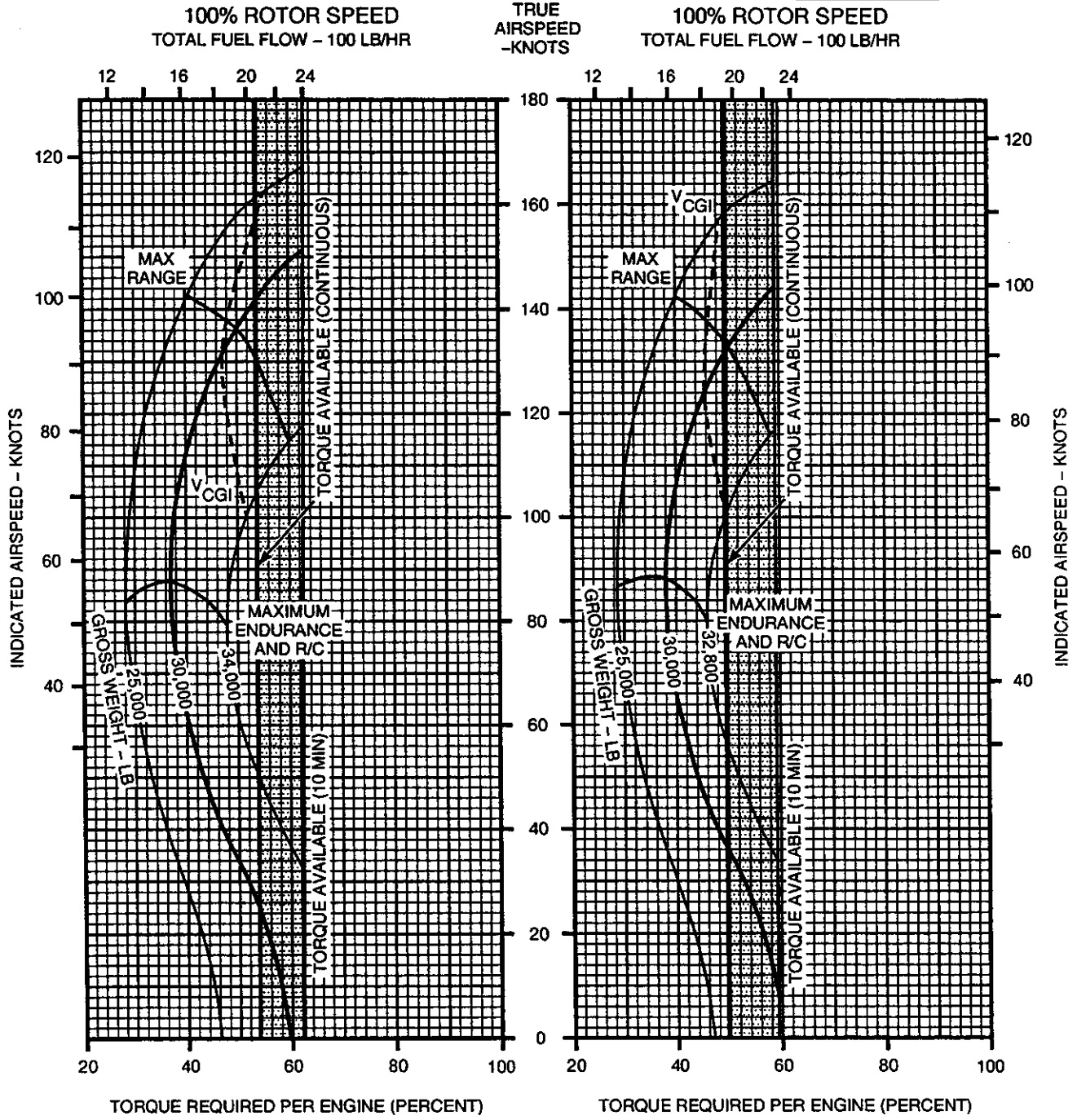
**PRESSURE ALTITUDE - 18000 FT**

**CRUISE  
CH-47D  
(2) T55-GA-714A**

**CLEAN CONFIGURATION**

**FAT = 10°C**

**FAT = 20°C**



DATA BASIS: FLIGHT TEST

A60226

Figure 7A-86. 100% Rotor RPM, 10° and 20°C, 18,000 Feet

**CRUISE**

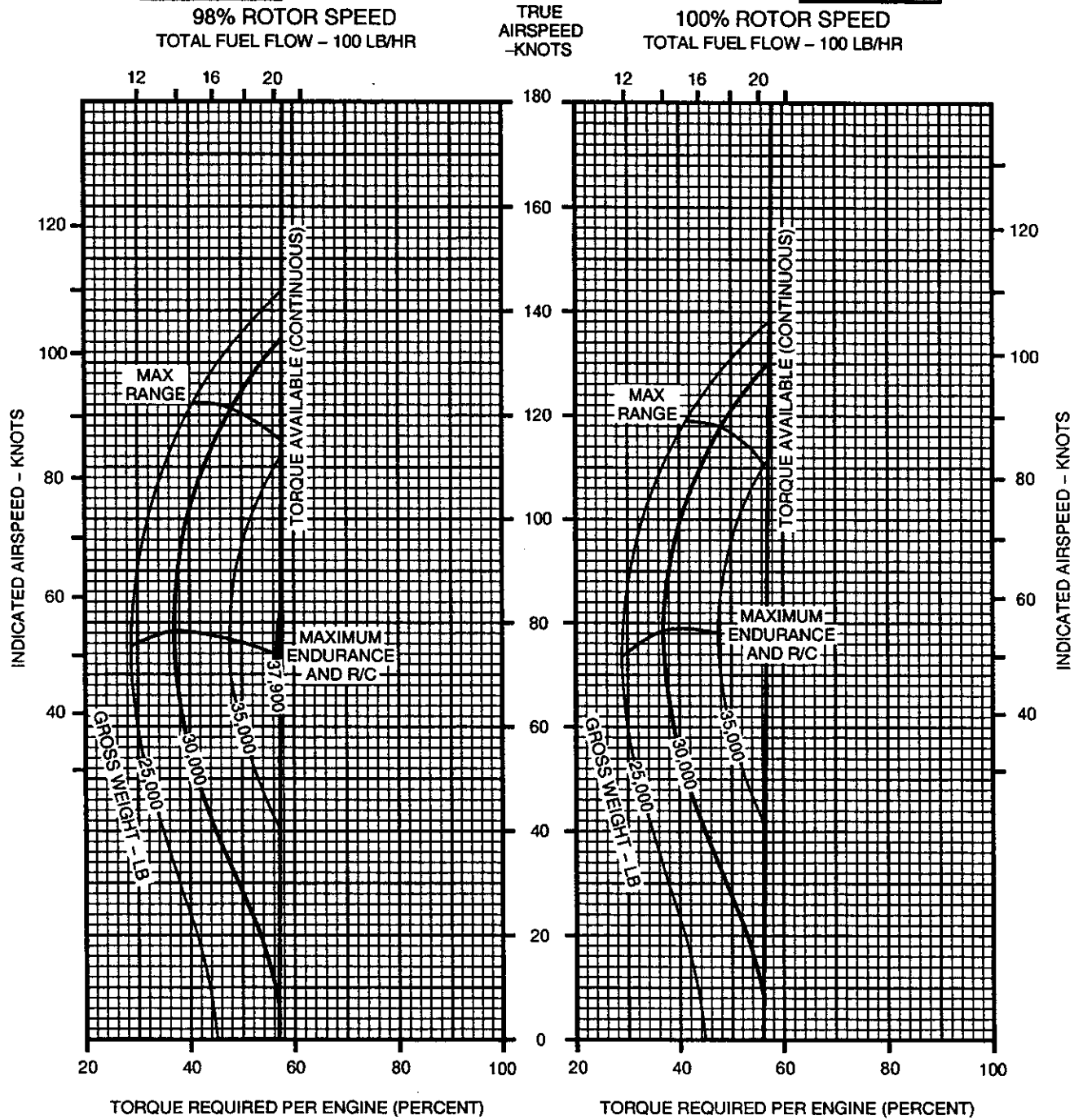
**PRESSURE ALTITUDE - 20000 FT**

**CRUISE  
CH-47D  
(2) T55-GA-714A**

**CLEAN CONFIGURATION**

**FAT = -50°C**

**FAT = -50°C**



DATA BASIS: FLIGHT TEST

**Figure 7A-87. 98 and 100% Rotor RPM, -50°C, 20,000 Feet**

A60227



**CRUISE**

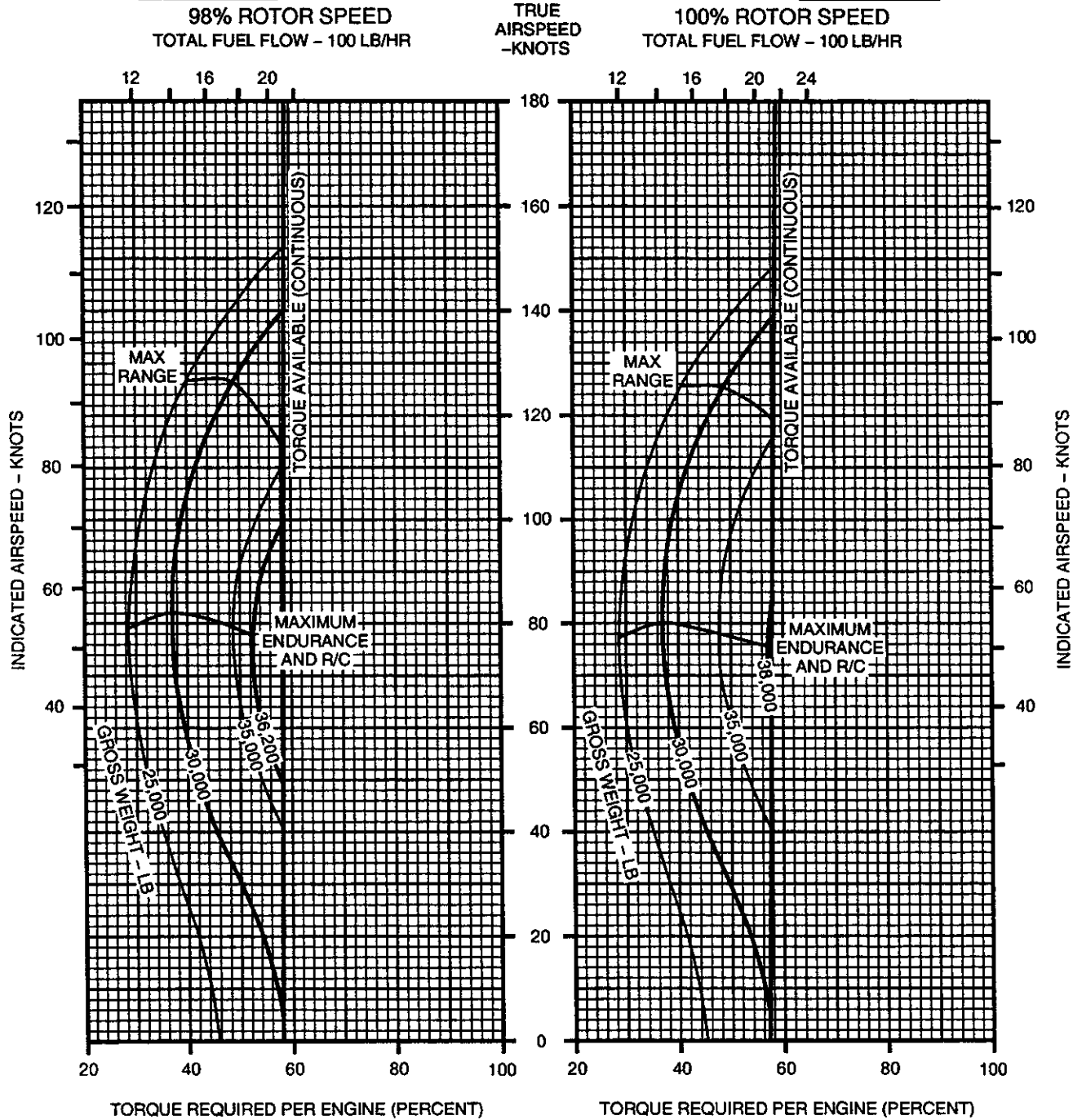
**PRESSURE ALTITUDE - 20000 FT**

**CRUISE  
CH-47D  
(2) T55-GA-714A**

**CLEAN CONFIGURATION**

**FAT = -40°C**

**FAT = -40°C**



DATA BASIS: FLIGHT TEST

A60228

**Figure 7A-88. 98 and 100% Rotor RPM, -40°C, 20,000 Feet**

**CRUISE**

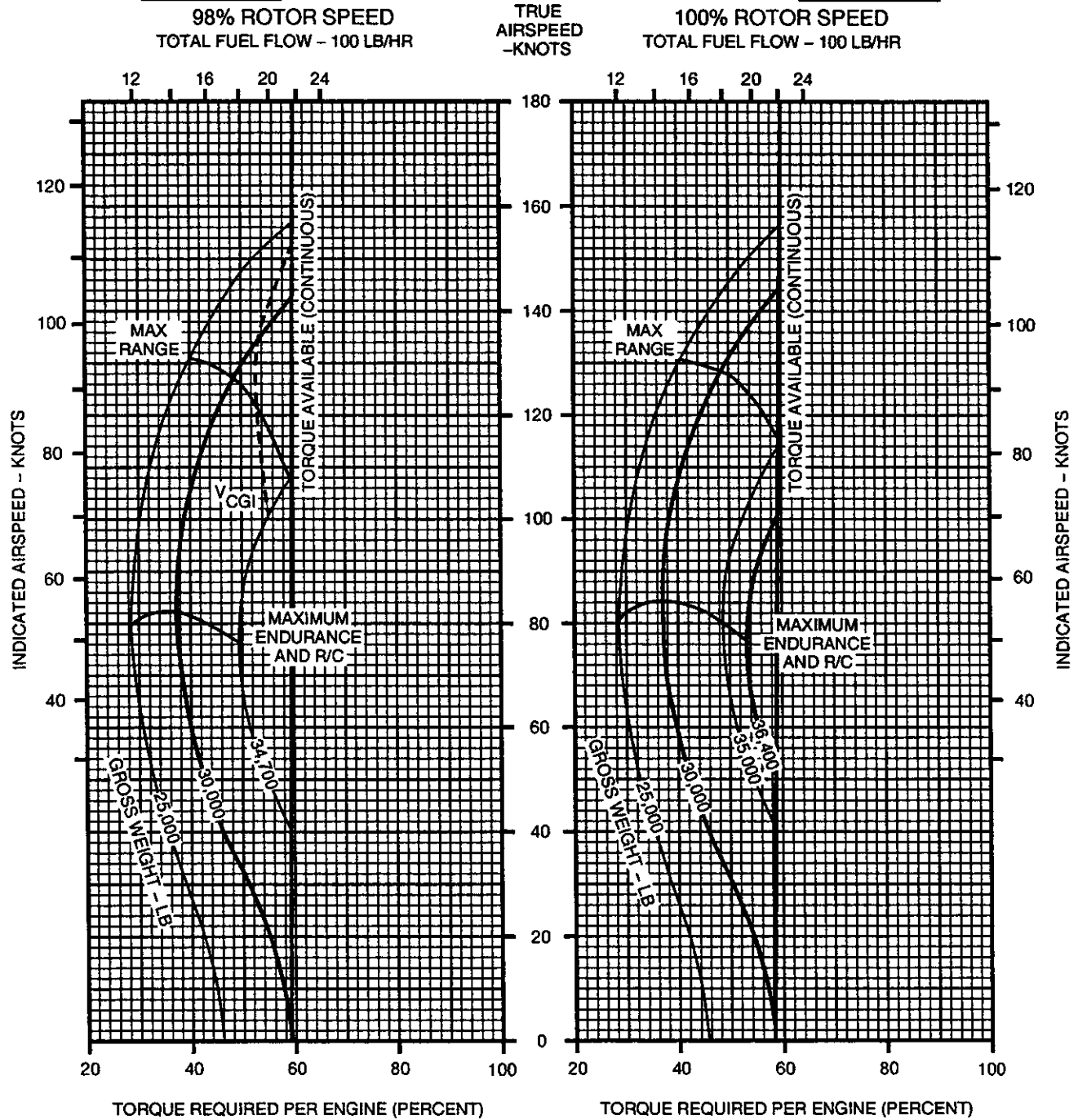
**PRESSURE ALTITUDE - 20000 FT**

**CRUISE  
CH-47D  
(2) T55-GA-714A**

**CLEAN CONFIGURATION**

**FAT = -30°C**

**FAT = -30°C**



DATA BASIS: FLIGHT TEST

**Figure 7A-89. 98 and 100% Rotor RPM, -30°C, 20,000 Feet**

A60229

**CRUISE**

**PRESSURE ALTITUDE - 20000 FT**

**CRUISE  
CH-47D  
(2) T55-GA-714A**

**CLEAN CONFIGURATION**

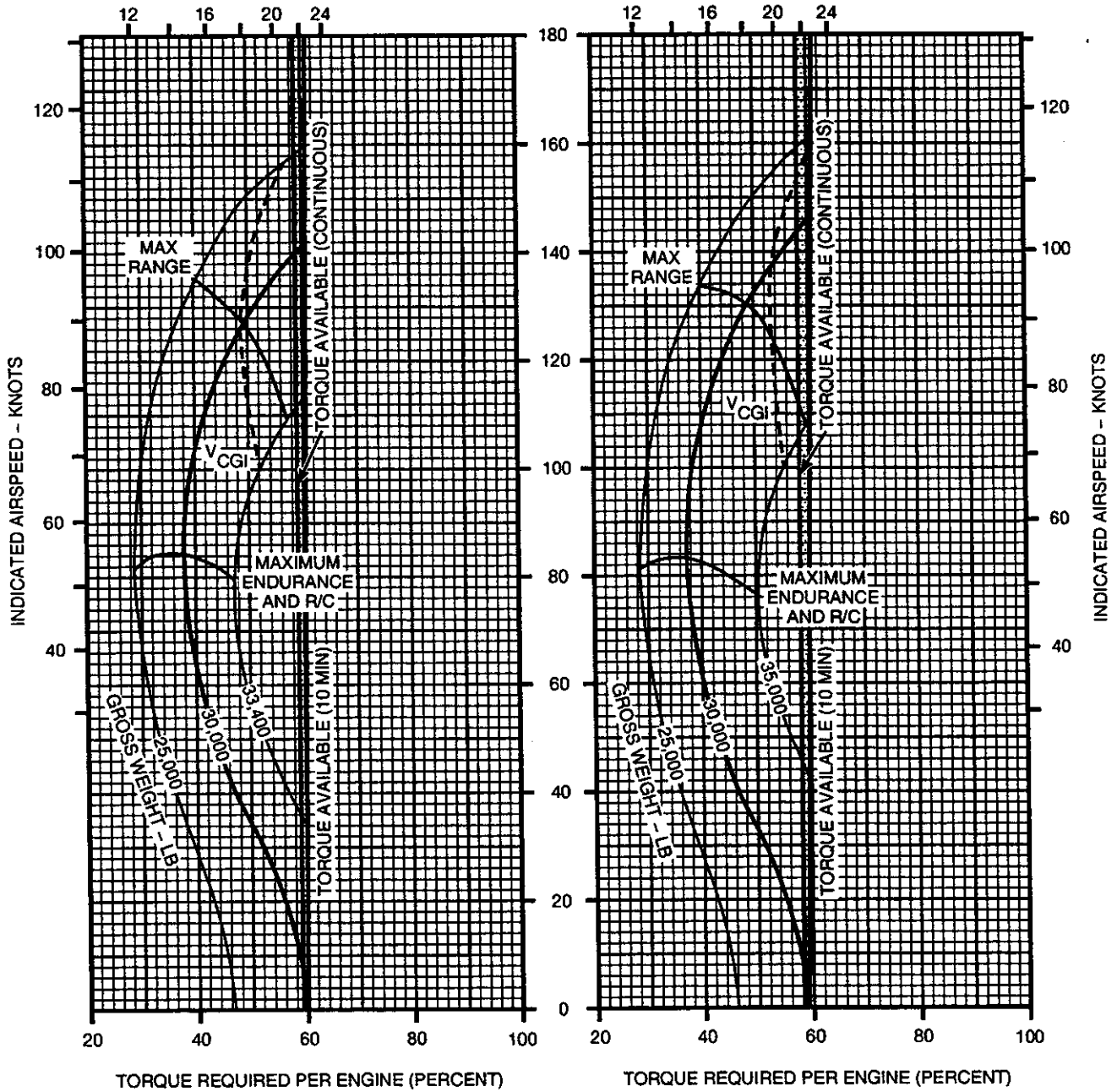
**FAT = -20°C**

**FAT = -20°C**

**98% ROTOR SPEED  
TOTAL FUEL FLOW - 100 LB/HR**

**TRUE  
AIRSPEED  
-KNOTS**

**100% ROTOR SPEED  
TOTAL FUEL FLOW - 100 LB/HR**



DATA BASIS: FLIGHT TEST

A60230

Figure 7A-90. 98 and 100% Rotor RPM, -20°C, 20,000 Feet

**CRUISE**

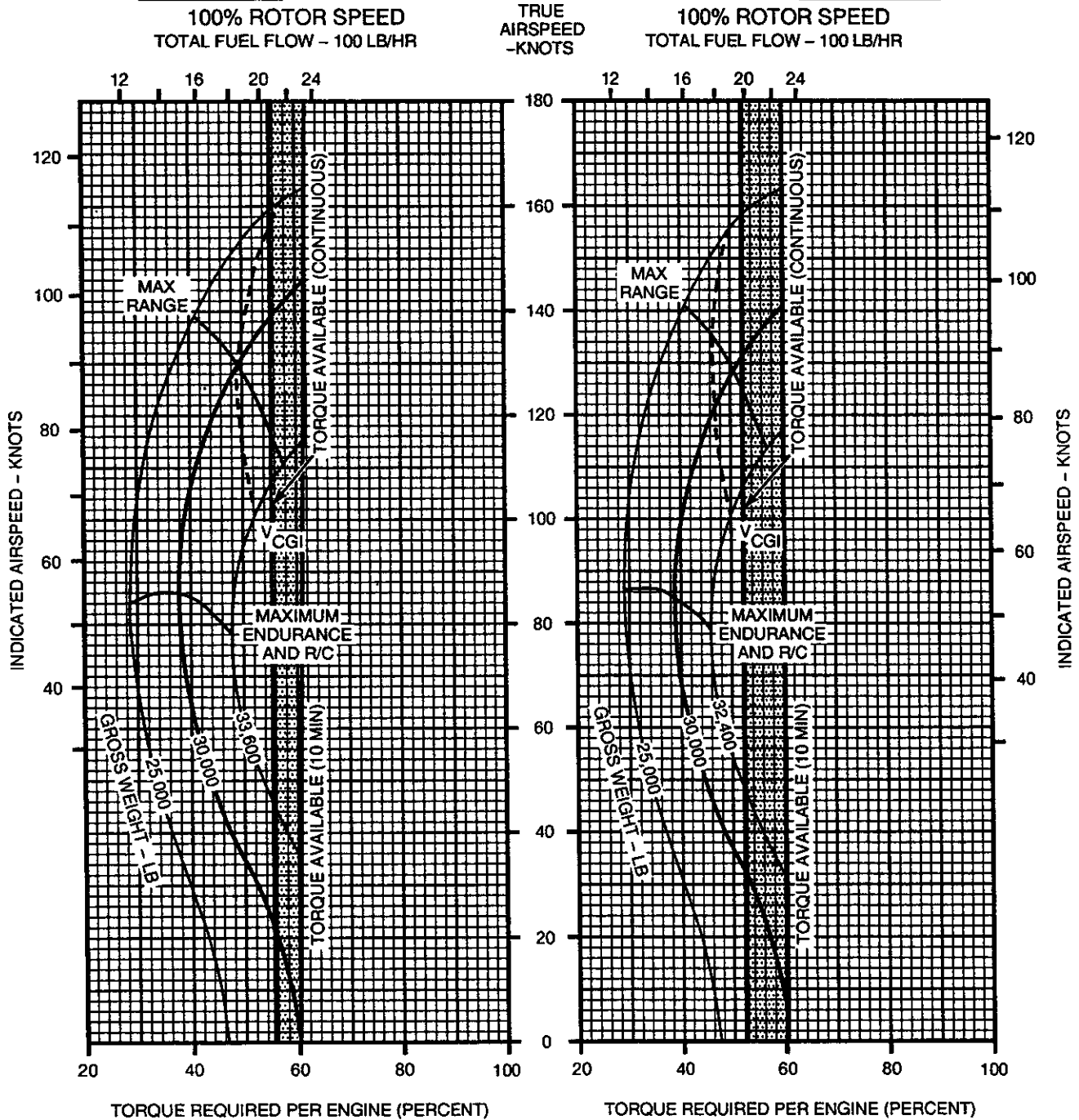
**PRESSURE ALTITUDE - 20000 FT**

**CRUISE  
CH-47D  
(2) T55-GA-714A**

**CLEAN CONFIGURATION**

**FAT = -10°C**

**FAT = 0°C**



**Figure 7A-91. 100% Rotor RPM, -10° and 0°C, 20,000 Feet**

A60231

**CRUISE**

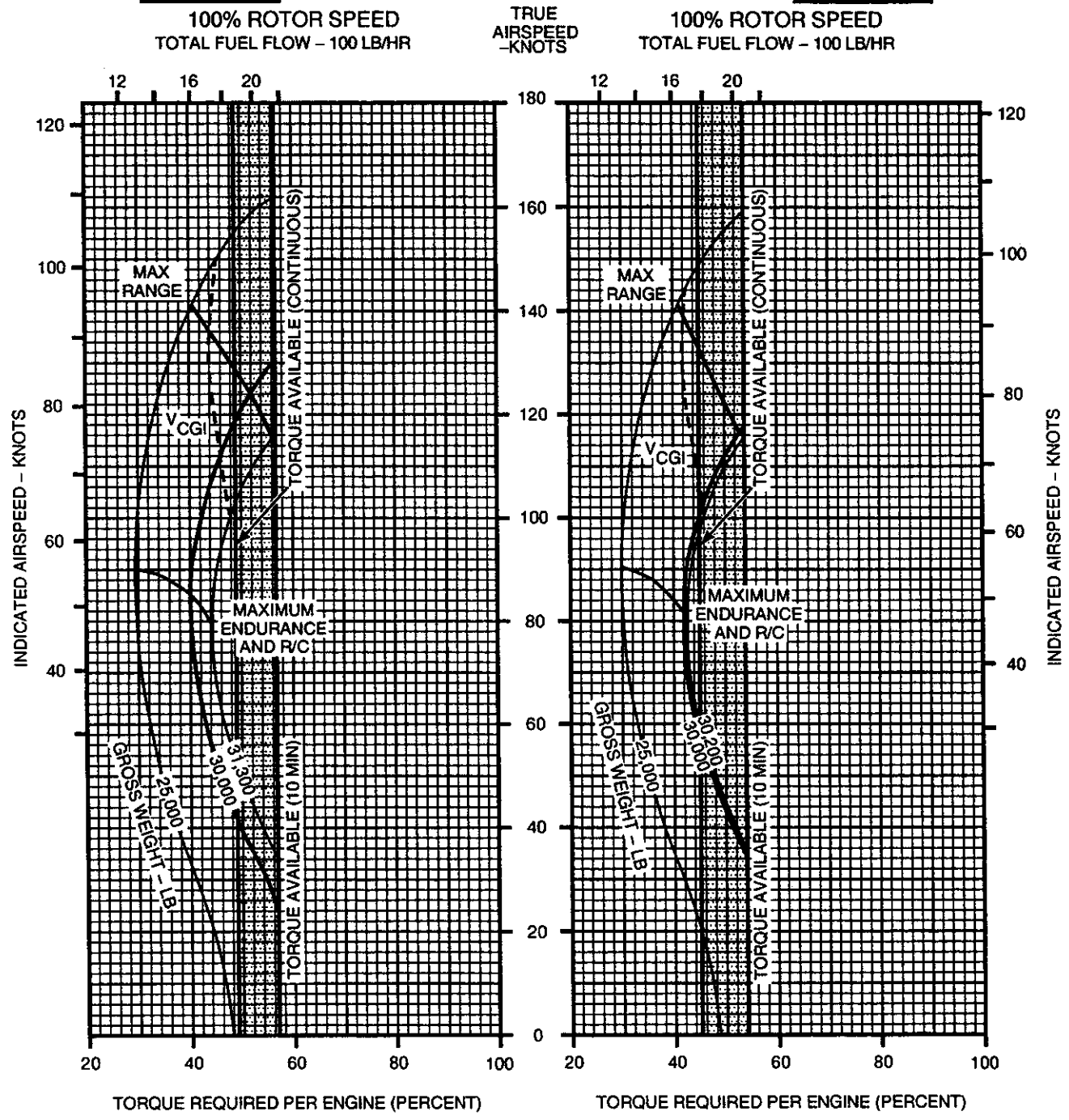
**PRESSURE ALTITUDE - 20000 FT**

**CRUISE  
CH-47D  
(2) T55-GA-714A**

**CLEAN CONFIGURATION**

**FAT = 10°C**

**FAT = 20°C**



A60232

**Figure 7A-92. 100% Rotor RPM, 10° and 20° C, 20,000 Feet**

**SECTION VIII DRAG**

**7A-31. Description.**

The drag chart (fig. 7A-93) shows the torque change required for flight due to drag area change as a result of external configuration changes.

**7A-32. Use of Charts.**

The primary use of the chart is illustrated by the example. To determine the change in torque, it is necessary to know the drag area change, TAS, PA, and FAT. From the table below find the drag area change associated with the configuration, or estimate if necessary. Enter chart at known drag area change, move right to TAS, move down to PA, move left to FAT, then move down and read change in engine torque.

**7A-33. Conditions.**

The drag chart is based on operating at 100% RRPM.

**Table 7A-1. Change in Drag Area of Typical External Loads**

LOAD	DRAG AREA CHANGE SQ FT
8 FT X 8 FT X 20 FT CONEX CONTAINER	150/100(1)
(2) 500 GAL FUEL CELLS	40
(3) 500 GAL FUEL CELLS	60
(4) 500 GAL FUEL CELLS	80
M35-2 <sup>1</sup> / <sub>2</sub> TON CARGO TRUCK	80
M37-3 <sup>3</sup> / <sub>4</sub> TON CARGO TRUCK	60
HMMWV (ENCLOSED VEHICLE)	49/28(1)
HMMWV (TOW LAUNCHER)	54/31(1)
M2A1-105MM HOWITZER	50
M102-105MM HOWITZER	50
M198-155MM HOWITZER GUN	149/50(1)
OH-6 HELICOPTER	40(2)
CH-47 HELICOPTER	230(2)
OV-10 FIXED WING AIRCRAFT	80(2)
(1) WITH DUAL POINT SUSPENSION	
(2) RIGGED IN ACCORDANCE WITH FM1-513, JAN 1990	DATA BASIS: ESTIMATED/ FLIGHT TEST

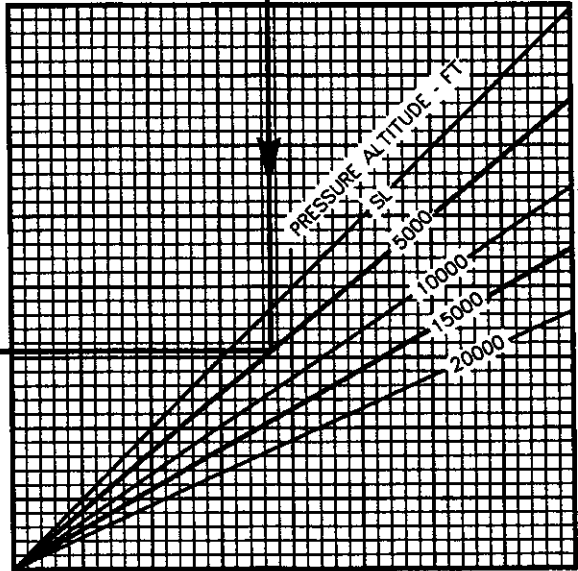
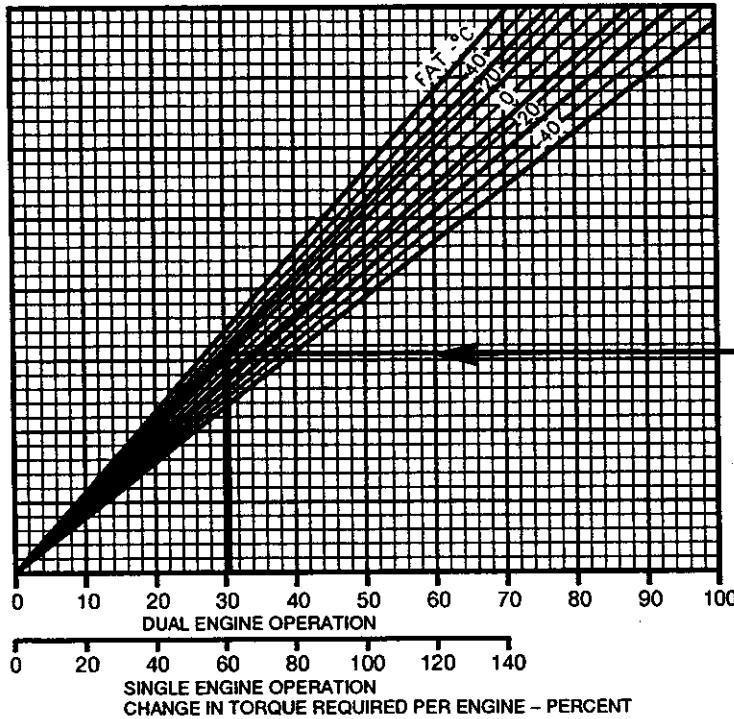
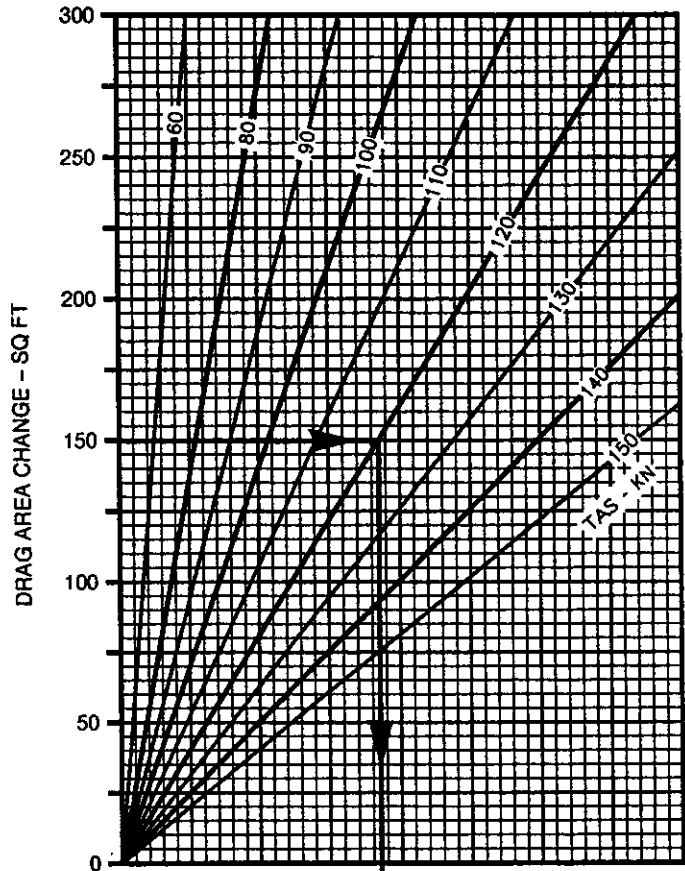
**DRAG**  
100% ROTOR RPM

**DRAG**  
CH-47D  
T55-GA-714A

**EXAMPLE**  
**WANTED**  
ADDITIONAL TORQUE REQUIRED FOR CRUISE  
WITH AN EXTERNAL LOAD

**KNOWN**  
EXTERNAL LOAD = 8 X 8 X 20 FT CONEX CONTAINER  
TRUE AIRSPEED = 120 KN  
PRESSURE ALTITUDE = 5,000 FT  
FAT = 20°C

**METHOD**  
FROM THE TABLE OPPOSITE DETERMINE THE EQUIVALENT  
DRAG AREA OF THE LOAD = 150 SQ FT  
ENTER THIS VALUE OF DRAG AREA HERE  
MOVE RIGHT TO DESIRED TRUE AIRSPEED = 120 KN  
MOVE DOWN TO PRESSURE ALTITUDE = 5,000 FT  
MOVE LEFT TO FAT = 20°C  
MOVE DOWN, READ ADDITIONAL TORQUE REQUIRED  
PER ENGINE = 31 PERCENT, DUAL ENGINE, AND  
62 PERCENT SINGLE ENGINE OPERATION



DATA BASIS: CALCULATED

A60115

Figure 7A-93. Drag Chart

## SECTION IX CLIMB-DESCENT

### 7A-34. Description.

a. Climb and descent performance may be seen in figure 7A-94, which presents change in torque to climb or descend at selected GWs.

b. The climb performance charts, figure 7A-95, shows relationships between GW, initial and final altitude and temperatures, time to climb, and distance covered and fuel used while climbing. The chart is presented for climbing at **hotter and colder** temperatures, intermediate torque (30 minute operation).

### 7A-35. Use of Charts.

The primary use of the charts is illustrated by the chart examples.

a. To determine torque change for a specified rate of climb or rate of descent (fig. 7A-94), enter rate of climb or descent and move right to gross weight, move down and read torque change. This torque change must be added to the torque required for level flight for climb, or subtracted for descent, to obtain total climb or descent torque.

b. Rate of climb or descent may also be obtained by entering with a known torque change, moving upward to gross weight, moving left and reading rate of climb or descent.

c. To use the climb performance charts (fig. 7A-95), enter at the top left at the known gross weight, move right to the initial press alt (pressure altitude), move down to the FAT at that altitude, and move left and record time, distance, and fuel. Enter again at the GW, move right to the final altitude, move down to the FAT at that altitude, and move left and record time, distance, and fuel. Subtract the time, distance, and fuel values of the initial altitude-temperature condition from those of the final altitude-temperature condition to find the time to climb, distance covered, and fuel used while climbing.

### 7A-36. Conditions.

The climb and descent charts are based on 100% RRPM. The climb speed schedule shown in figure 7A-95 (see insert) is for optimum climb, that is, minimum power required and maximum power available (30 minutes). It is an average schedule for the GW range and atmospheric conditions for the CH-47D.



**CLIMB/DESCENT**

**CLIMB/DESCENT**  
**CH-47D**  
**(2) T55-GA-714A**

**EXAMPLE**

**WANTED**

TORQUE CHANGE REQUIRED  
 FOR DESIRED R/C OR R/D

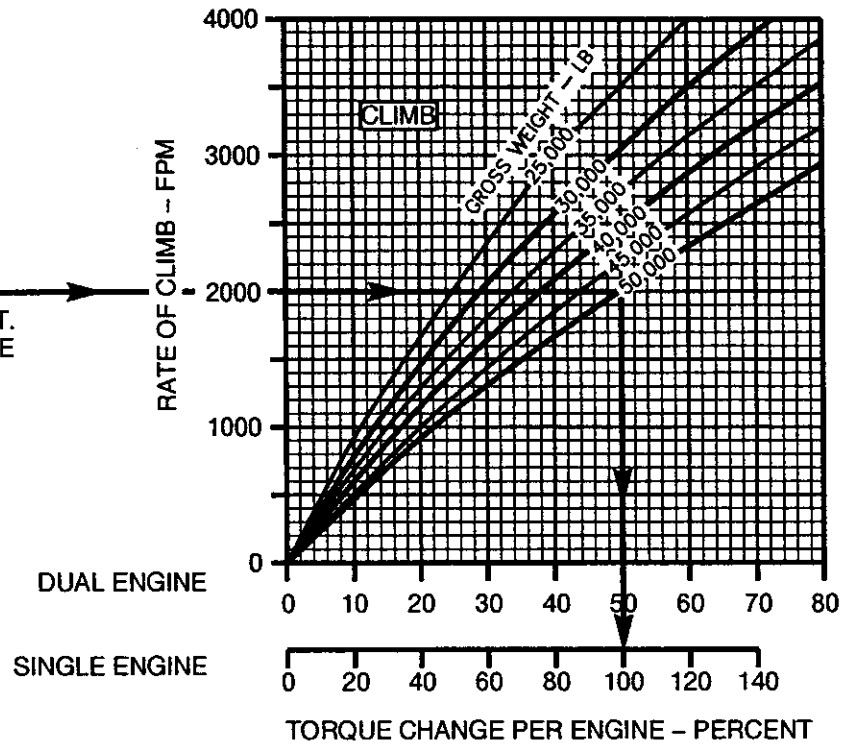
**KNOWN**

GROSS WEIGHT = 50,000 LB  
 DESIRED R/C = 2,000 FPM

**METHOD**

ENTER DESIRED R/C HERE →  
 MOVE RIGHT TO GROSS WEIGHT.  
 MOVE DOWN AND READ TORQUE  
 CHANGE PER ENGINE = 50%  
 DUAL ENGINE AND 100%  
 SINGLE ENGINE  
 OPERATION.

100% ROTOR RPM

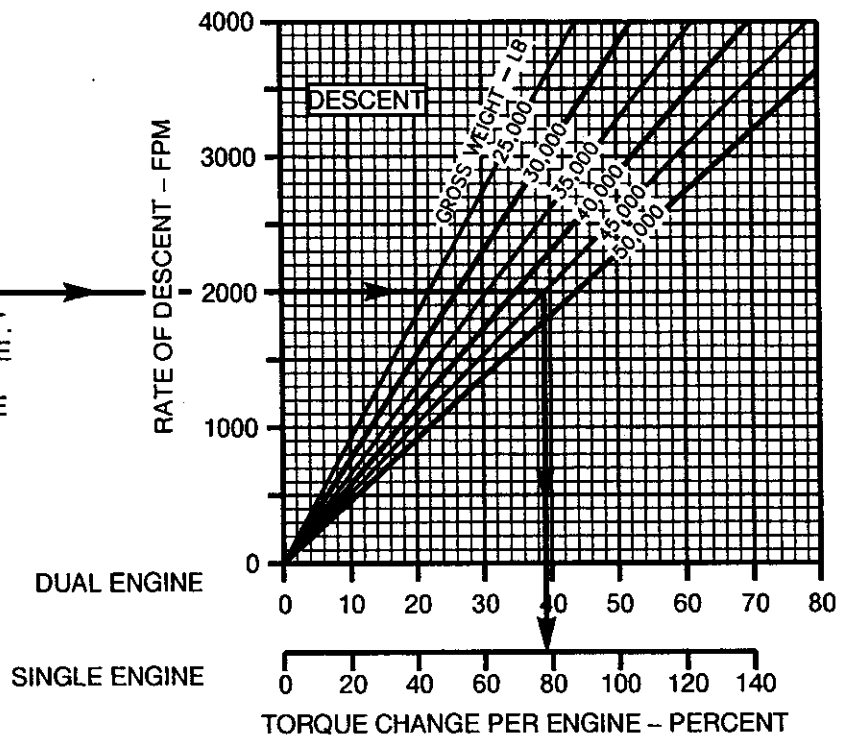


**KNOWN**

GROSS WEIGHT = 45,000 LB  
 DESIRED R/D = 2,000 FPM

**METHOD**

ENTER DESIRED R/D HERE →  
 MOVE RIGHT TO GROSS WEIGHT.  
 MOVE DOWN AND READ TORQUE  
 CHANGE PER ENGINE = 39.0%  
 DUAL ENGINE AND 78.0% SINGLE  
 ENGINE OPERATION.



DATA BASIS: FLIGHT TEST

A60121

Figure 7A-94. Climb — Descent Chart

# CLIMB PERFORMANCE

HOTTER TEMPERATURES  
 INTERMEDIATE TORQUE - 30 MIN. OPERATION  
 100% ROTOR SPEED

CLIMB  
 CH-47D  
 (2) T55-GA-714A

CLIMB SPEED = MAXIMUM R/C SPEED FROM CRUISE CHARTS

## EXAMPLE

### WANTED

TIME TO CLIMB  
 DISTANCE TRAVELED  
 CLIMB SPEED

### KNOWN

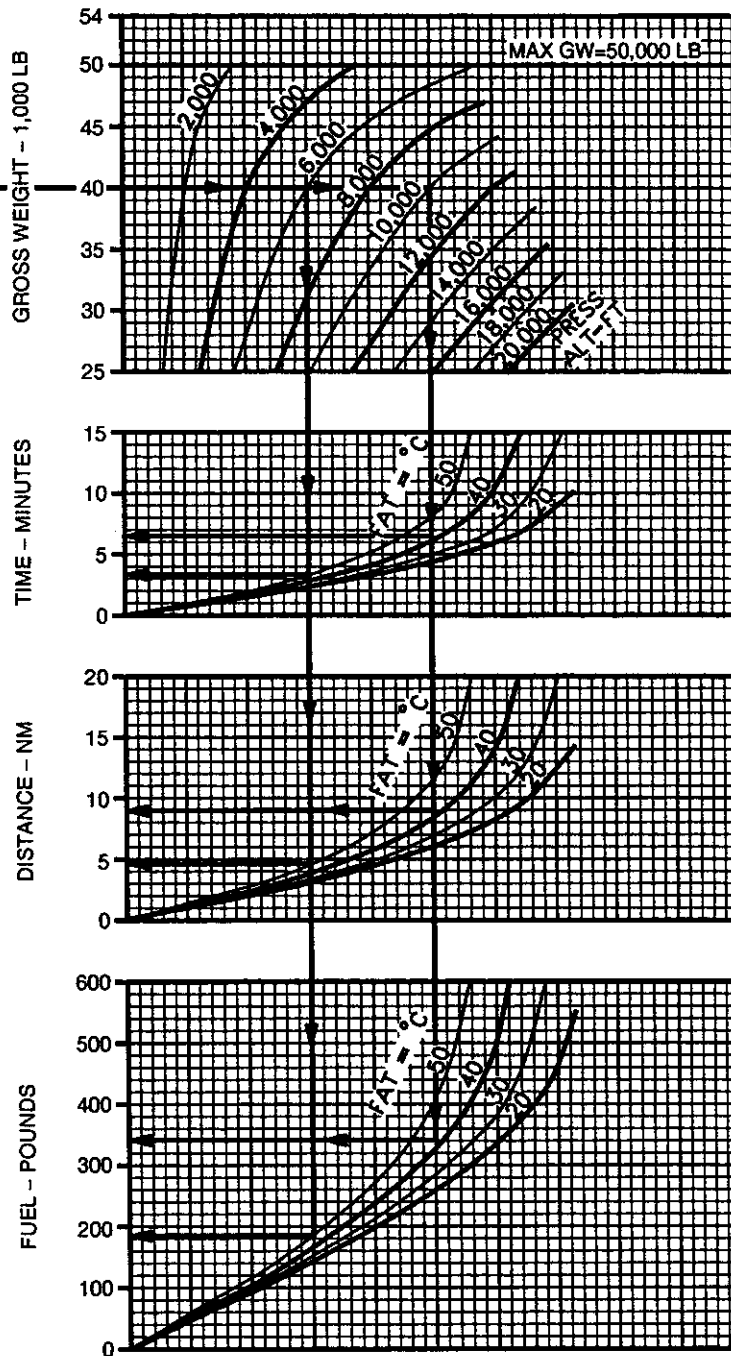
GROSS WEIGHT-40,000 LB  
 INITIAL PRESS. ALT-6,000 FT  
 FINAL PRESS. ALT-10,000 FT  
 INITIAL FAT 50°C  
 FINAL FAT ESTIMATED AT, 42°C

### METHOD

ENTER GROSS WEIGHT HERE  
 MOVE RIGHT TO INITIAL PRESS. ALT.  
 MOVE DOWN TO INITIAL FAT ON  
 TIME, DIST., AND FUEL CHARTS  
 MOVE LEFT AND READ:  
 TIME=3.4 MIN  
 DIST.=4.6 NM  
 FUEL=182 LB

REENTER AT SAME GROSS WEIGHT  
 MOVE RIGHT TO FINAL PRESS. ALT.  
 MOVE DOWN TO FINAL FAT ON  
 TIME, DIST., AND FUEL CHARTS  
 TIME=6.5 MIN  
 DIST.=9.0 NM  
 FUEL=340 LB

- TIME TO CLIMB=(6.5-3.4)=3.1 MIN
- DIST. COVERED=(9.0-4.6)=4.4 NM
- FUEL USED=(340-182)=158 LB



DATA BASIS: FLIGHT TEST

Figure 7A-95. Climb Performance (Sheet 1 of 2)

A60128

# CLIMB PERFORMANCE

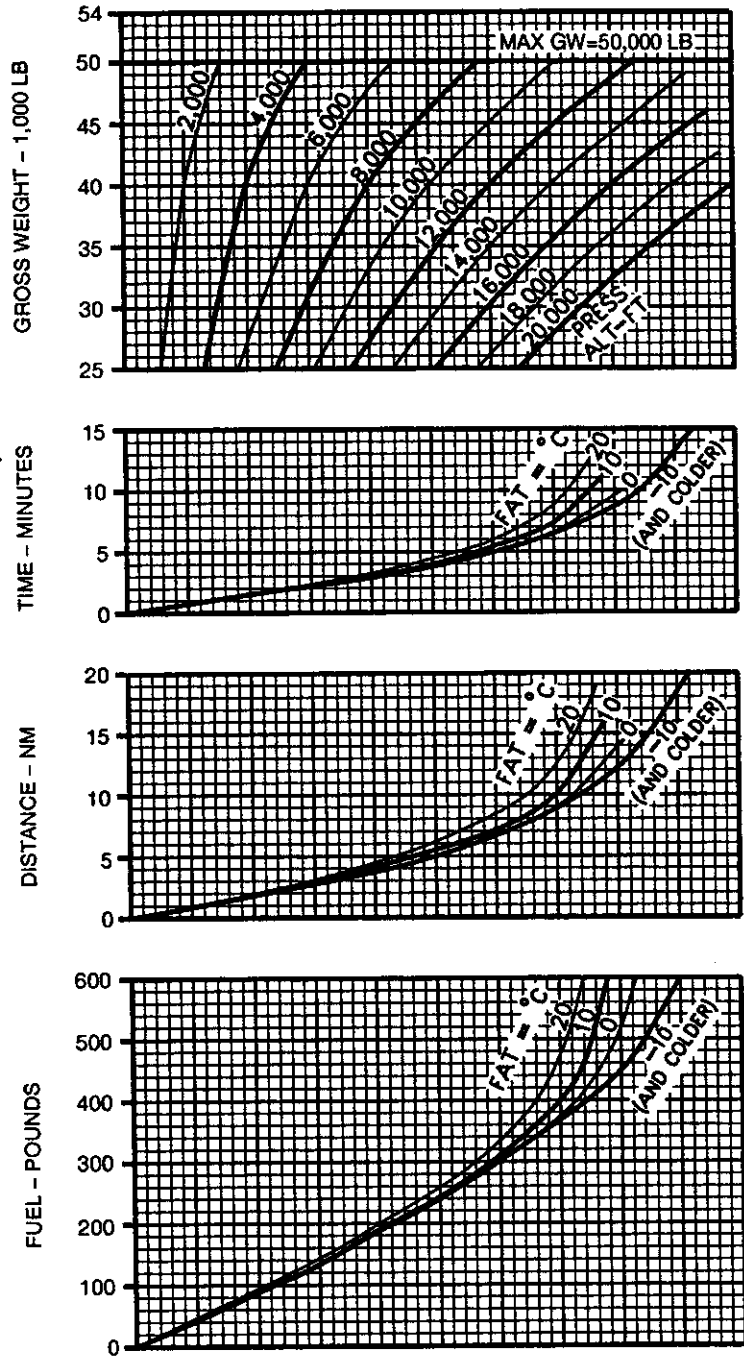
COLDER TEMPERATURES

INTERMEDIATE TORQUE - 30 MIN. OPERATION

100% ROTOR SPEED

CLIMB SPEED = MAXIMUM R/C SPEED FROM CRUISE CHARTS

CLIMB  
CH-47D  
(2) T55-GA-714A



DATA BASIS: FLIGHT TEST

A60129

Figure 7A-95. Climb Performance (Sheet 2 of 2)

## SECTION X FUEL FLOW

### 7A-37. Description.

The idle fuel flow chart (fig. 7A-96) presents engine fuel flow sensitivity to PA and FAT for ground idle and flight idle.

### 7A-38. Use of Chart.

The primary use of the charts is illustrated by the example. To determine idle fuel flow, it is necessary to know idle condition, PA, and FAT. Enter PA, move right to FAT, move down and read fuel flow.

### 7A-39. Conditions.

- a. Presented charts are based on the use of JP-4 fuel.
- b. Ground idle is defined at 50 to 59 percent N1.
- c. Thrust ground detent is defined as engine condition levers at FLT, NR selected 97%, and thrust control at the detent.
- d. The single engine fuel flow chart (fig. 7A-97) baseline is 0°C. Increase or decrease fuel flow by 1 percent for every 10°C change in temperature.

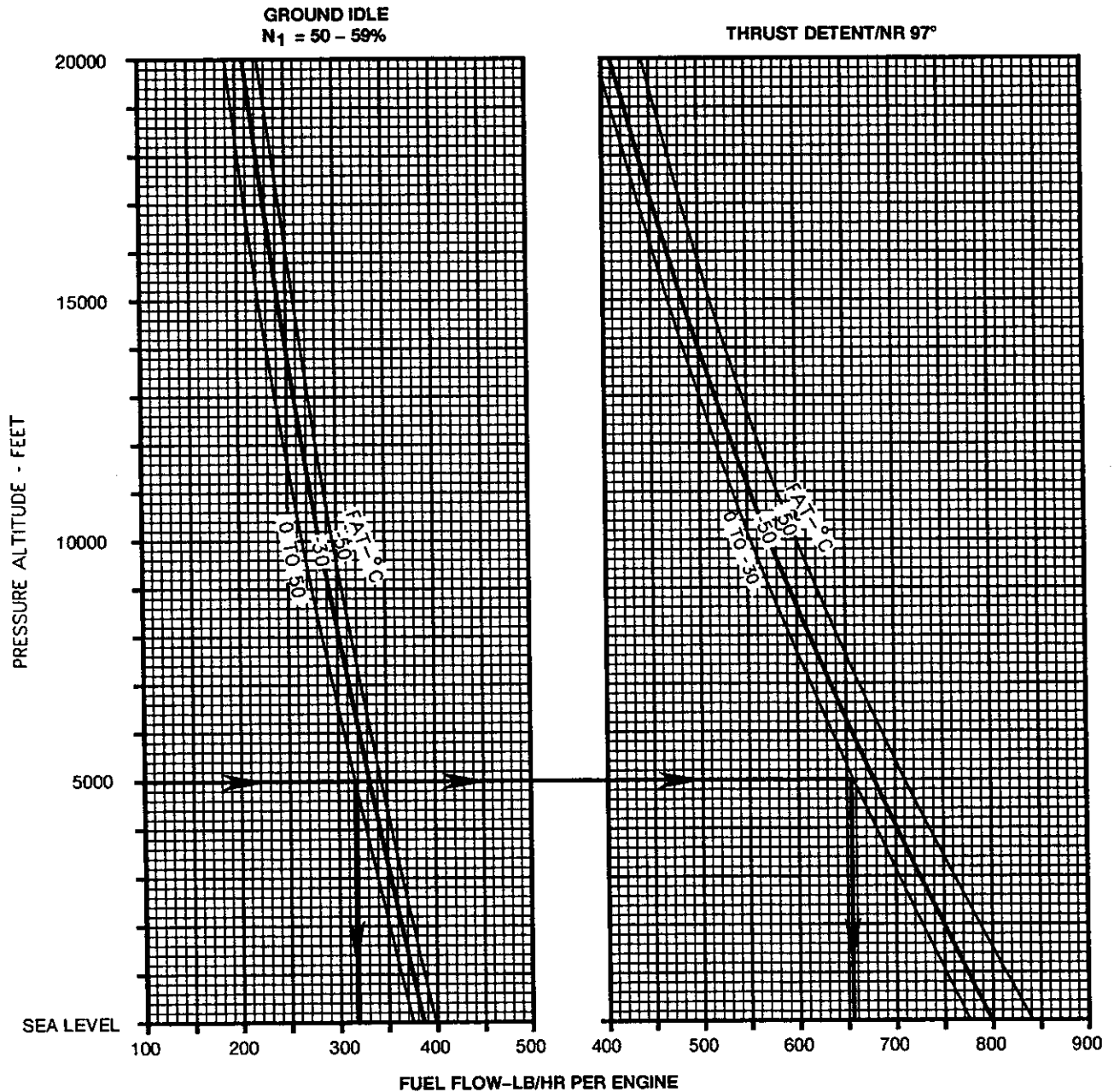
# IDLE FUEL FLOW

IDLE FUEL FLOW  
CH-47D  
T55-GA-714A

**WANTED**  
IDLE FUEL FLOW AT GROUND IDLE AND MINIMUM GOVERNING

**KNOWN**  
PRESSURE ALTITUDE = 5000 FT/FAT = 0°C

**METHOD**  
ENTER PRESSURE ALTITUDE AT 5000 FT. MOVE RIGHT TO FAT.  
FOR GROUND IDLE AND MINIMUM GOVERNING, MOVE DOWN. READ GROUND  
IDLE FUEL FLOW = 317 LB/HR PER ENGINE AND MINIMUM GOVERNING FUEL  
FLOW = 657 LB/HR PER ENGINE.



DATA BASIS: CALCULATED FROM MODEL SPEC. LES-714-88-01

A75384

**Figure 7A-96. Idle Fuel Flow Chart**

**SINGLE ENGINE FUEL FLOW**  
100% ROTOR RPM

**SINGLE ENGINE FUEL FLOW**  
CH-47D  
T55-GA-714A

FAT=0°C

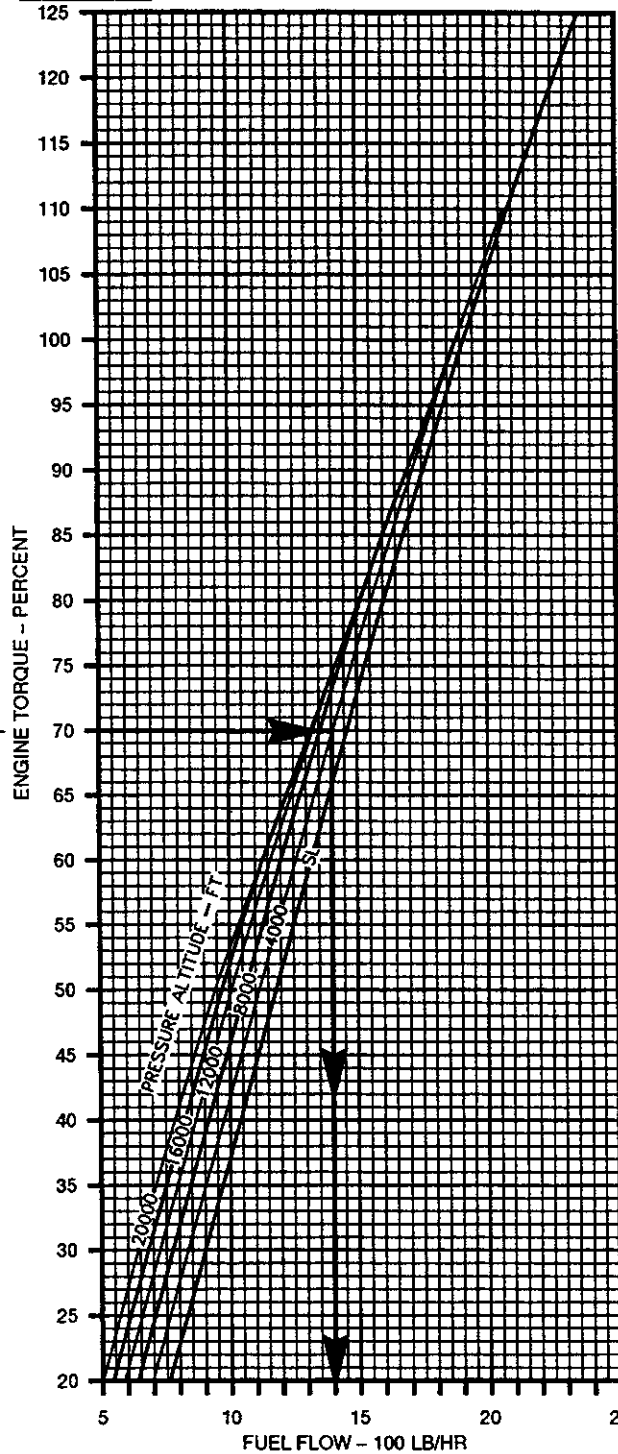
**EXAMPLE**

**WANTED**  
SINGLE ENGINE FUEL FLOW

**KNOWN**  
TORQUE = 70%  
PRESSURE ALTITUDE = 4000 FEET  
FAT = 10°C

**METHOD**  
ENTER AT 70% TORQUE HERE  
MOVE RIGHT TO 4000 FEET  
PRESSURE ALTITUDE, THEN DOWN  
AND READ 1405 LB/HR FUEL FLOW.  
SINCE FAT IS 10° ABOVE THE  
BASELINE OF THIS CHART,  
INCREASE FUEL FLOW BY 1%  
FOR EVERY 10°C  
 $1405 \times .01 = 14$  POUNDS/HR  
 $1405 + 14 = 1419$  POUNDS/HR

**NOTE**  
BASELINE IS 0°C  
INCREASE OR DECREASE FUEL  
FLOW BY 1% FOR EVERY  
10°C CHANGE IN TEMP



DATA BASIS: CALCULATED

A60117

Figure 7A-97. Single Engine Fuel Flow Chart

## SECTION XI AIRSPEED CALIBRATION

### 7A-40. Description.

The airspeed calibration chart, figure 7A-98, defines the relationship between indicated (IAS), and calibrated airspeed (CAS) for level flight, climb, and autorotation.

### 7A-41. Use of Chart.

The primary use of the chart is illustrated by the example. To determine calibrated airspeed, it is necessary to know

IAS and flight regime. Enter chart at indicated airspeed, move right to appropriate flight regime, move down and read calibrated airspeed.

### 7A-42. Conditions.

Presented airspeed calibration charts are for CH-47D helicopters with T55-GA-714A engines.

# AIRSPEED CALIBRATION

AIRSPEED  
CH-47D

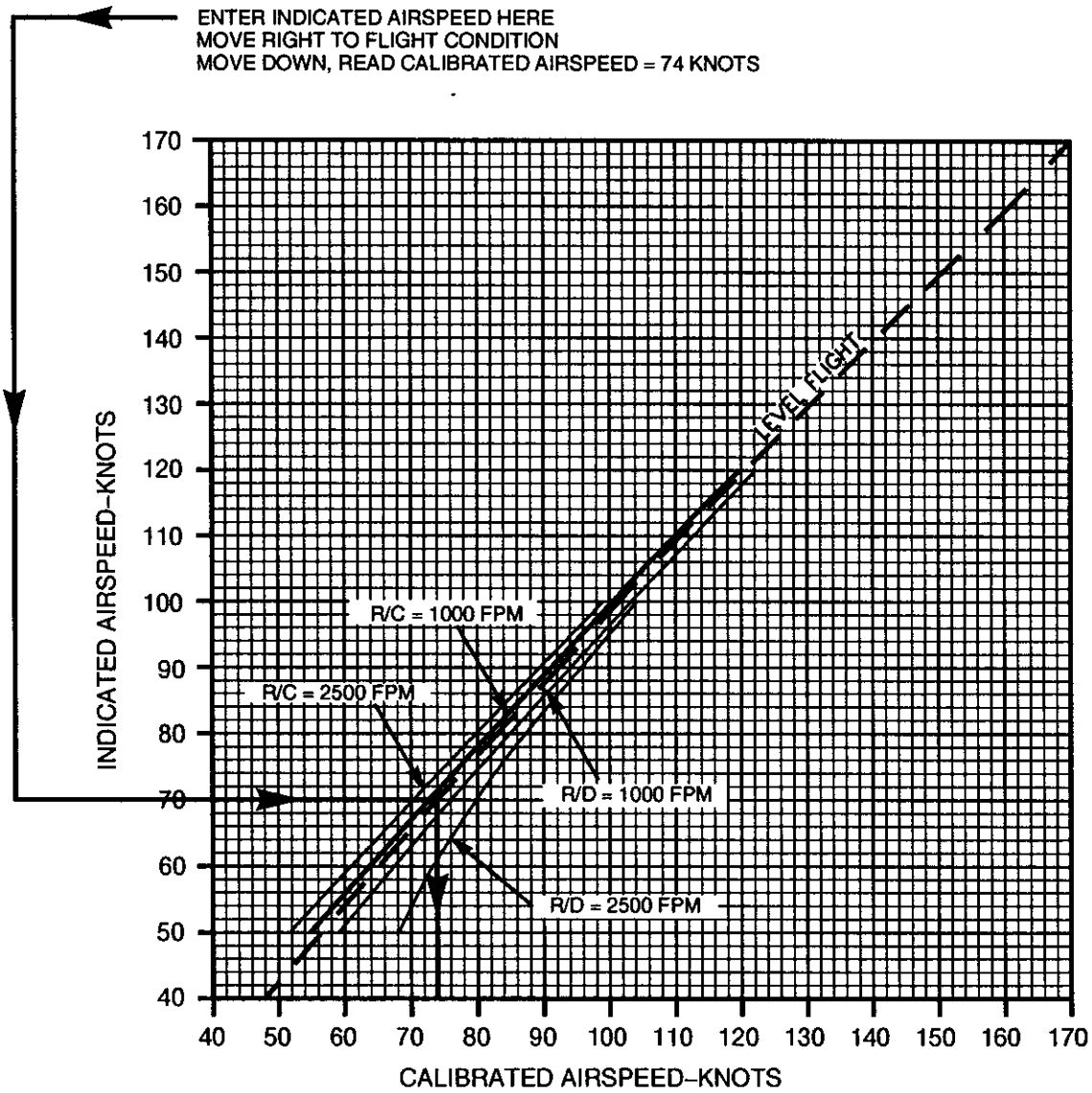
**EXAMPLE**

**WANTED**  
CALIBRATED AIRSPEED

**KNOWN**  
INDICATED AIRSPEED = 70 KNOTS  
FLIGHT CONDITION = LEVEL FLIGHT

**METHOD**

ENTER INDICATED AIRSPEED HERE  
MOVE RIGHT TO FLIGHT CONDITION  
MOVE DOWN, READ CALIBRATED AIRSPEED = 74 KNOTS



DATA BASIS: FLIGHT TEST

A60110

Figure 7A-98. Airspeed Calibration Chart



## CHAPTER 8 NORMAL PROCEDURES

### SECTION I MISSION PLANNING

#### 8-1. Mission Planning.

Mission planning begins when the mission is assigned and extends to the preflight check of the helicopter. It includes, but is not limited to, checks of operating limits and restrictions, weight/balance and loading, performance, publications, flight plan, and crew briefings. The pilot in command shall ensure compliance with the contents of this manual that are applicable to the mission.

**8-2. Aviation Life Support Equipment (ALSE).** All aviation life support equipment required for mission, e.g., helmets, gloves, survival vests, survival kits, etc., shall be checked.

**8-3. Crew Duties/Responsibilities.** The minimum crew required to fly the helicopter is a pilot, copilot, and flight engineer. Additional crewmembers, as required, may be added at the discretion of the commander. The manner in which each crewmember performs his related duties is the responsibility of the pilot in command.

a. *Pilot.* The pilot in command is responsible for all aspects of mission planning, preflight, and operation of the helicopter. He will assign duties and functions to all other crewmembers as required. Prior to or during preflight, the pilot will brief the crew on the mission, performance data, monitoring of instruments, communications, emergency procedures, and armament procedures.

b. *Copilot.* The copilot must be familiar with the pilot's duties and the duties of the other crew positions. The copilot will assist the pilot as directed.

c. *Flight Engineer.* The flight engineer will perform all duties as assigned by the pilot in addition to the following specific duties:

- (1) Performs or coordinates maintenance, servicing, inspection, loading, and security of the helicopter.
- (2) Checks that log book is current and correct.
- (3) Accompanies pilot during preflight inspection; performs the inspection with the pilot.
- (4) Checks the security of each area inspected.
- (5) Assists in seating and securing passengers; checks load security.
- (6) Ensures the helicopter is clear during all starting procedures and informs the pilots of any objects which would pose a hazard to the helicopter during all phases of ground operation.

(7) Visually inspects engine and ramp area for proper operation.

(8) Remove chocks and closes ramp door when called for by the pilots.

(9) Observes and gives clearance to pilots during taxi and hover operation. Reports any object or condition which would pose a hazard to the helicopter. When the helicopter is being taxied in obstructed areas, the flight engineer or other crewmembers may be required to act as taxi director or blade watchers. Taxi directors and blade watchers must be familiar with CH-47 ground turning characteristics (fig. 2-3 and 8-1).

(10) Perform check of ramp area and MAINTENANCE PANEL every 30 minutes of flight.

**8-4. Crew Briefing.** A crew briefing shall be conducted to ensure a thorough understanding of individual and team responsibilities. The briefing should include, but not be limited to, copilot, mission equipment operator, and ground crew responsibilities and the coordination necessary to complete the mission in the most efficient manner. A review of visual signals is desirable when ground guides do not have a direct voice communications link with the crew.

**8-5. Passenger Briefing.** The following is a guide that should be used in accomplishing required passenger briefings. Items that do not pertain to a specific mission may be omitted.

a. *Crew introduction.*

b. *Equipment.*

- (1) Personal to include ID tags.
- (2) Professional.
- (3) Survival.

c. *Flight Data.*

- (1) Route.
- (2) Altitude.
- (3) Time en route.
- (4) Weather.

d. *Normal Procedures.*

- (1) Entry and exit of helicopter.
- (2) Seating.
- (3) Seat belts.

**TM 55-1520-240-10**

- (4) Movement in helicopter.
- (5) Internal communications.
- (6) Security of equipment.
- (7) Smoking.
- (8) Oxygen.
- (9) Refueling.
- (10) Weapons.
- (11) Protective masks.

- (12) Parachutes.
- (13) Ear protection.
- (14) ALSE.

*e. Emergency Procedures.*

- (1) Emergency exits.
- (2) Emergency equipment.
- (3) Emergency landing/ditching procedures.

## SECTION II OPERATING PROCEDURES AND MANEUVERS

### 8-6. Operating Procedures And Maneuvers.

This section deals with normal procedures and includes all steps necessary to ensure safe and efficient operation of the helicopter from the time a preflight begins until the flight is completed and the helicopter is parked and secured. Unique feel, characteristics, and reaction of the helicopter during various phases of operation and the techniques and procedures used for hovering, takeoff, climb, etc., are described, including precautions to be observed. Your flying experience is recognized; therefore, basic flight principles are avoided. Only the duties of the minimum crew necessary for the actual operation of the helicopter are included.

**8-7. Mission Equipment Checks.** Mission equipment checks are contained in Chapter 4, MISSION EQUIPMENT. Descriptions of functions, operations, and effects of controls are covered in Section III, FLIGHT CHARACTERISTICS, and are repeated in this section only when required for emphasis. Checks that must be performed under adverse environmental conditions, such as desert and cold weather operations, supplement normal procedures checks in this section and are covered in Section IV, ADVERSE ENVIRONMENTAL CONDITIONS.

**8-8. Symbols Definitions.** The checklist includes items that may not be checked by the flight engineer and that may or may not be installed. These items are annotated immediately preceding the check to which they are pertinent: **F** for flight engineer, and **0** to indicate a requirement if the equipment is installed. The symbol ★ indicated that a detailed procedure for the step is located in the detailed procedures section of the condensed checklist. When a helicopter is flown on a mission requiring intermediate stops, it is not necessary to perform all of the normal checks. The steps that are essential for safe helicopter operations on intermediate stops are designated as “**through flight**” checks. An **asterisk\*** indicates that performance of steps is mandatory for all “**through-flights**” when there has been no change in pilot-in-command. The asterisk applies only to checks performed prior to takeoff. Duties performed by individual in copilot station are indicated by a circle around the step number, i.e., (4). Step numbers with no circles around them may be performed by the aviator in either pilot or copilot’s seat.

**8-9. Checklist.** Normal procedures are given primarily in checklist form and amplified as necessary in accompanying paragraph form when a detailed description of a procedure or maneuver is required. A condensed version of the amplified checklist, omitting all explanatory text, is contained in the Operators and Crewmembers Checklist, TM 55-1520-240-CL.

**8-10. Preflight Check.** The pilot’s walk-around and interior checks are outlined in the following procedures. The preflight check is not intended to be a detailed mechanical inspection. The steps that are essential for

safe helicopter operation are included. The preflight may be made as comprehensive as conditions warrant at the discretion of the pilot.

### 8-11. Before Exterior Check.

- \*1. Publications—Check DA Forms 2408-12, -13, -14, -18, DD Form 365-4, and DD Form 1896, locally required forms and publications, and availability of operator’s manual (-10), and checklist (-CL).
- \*2. Ignition lock switch—On.
3. 712 EMERGENCY POWER panel—Check trip indicators and timers.
4. 712 Topping stops—Check stowed.
5. Cockpit area—Check as follows:
  - a. General condition.
  - b. Fire extinguisher—Check seal intact, DD Form 1574/1574-1, and security.
  - c. Jettisonable door release handles/latches.
  - d. Sliding windows.
- \*6. Forward transmission—Check oil level, filter button, and oil cooler condition.
7. Fuel sample—Check before first flight of the day.

### 8-12. INTERIOR CHECK.

#### 8-13. Forward Cabin.

1. Flight control closet—Check ILCA actuators for extended jam buttons and thrust idler assemblies for bent cracked arms. Check ILCA connecting link for cracks or displaced bearings.
2. Heater compartment—Check security of components and winch.
3. Emergency escape ax—Check condition and security.
4. Cabin door—Check condition and security.
5. Avionics equipment—Check security of components and connections. Determine whether both pilots displacement gyros are installed.
6. Fire extinguisher—Check seal intact, DD Form 1574/1574-1, and security.
7. Cabin escape panel—Check condition and security.
8. Transformer-rectifier air intake screens—Check both clear. A transformer-rectifier may fail if rags or other items stowed behind troop seats block the air intakes.
9. Seats, litters, first aid kits, cargo and jettisonable cabin window—Check condition and security.
10. Utility hatch door and lower rescue door—Check condition and position as required.

11. Center cargo hook — Check condition and position as required. Check **2,100** psi charge, manual release mechanisms stowed, manual release mechanism for proper cam position and latched.

**CAUTION**

**Do not lift or rotate the center cargo hook into the cabin area or allow the mid hook to lay on the cargo floor or access door panel during inspection or use. The excessive tension placed on the triple emergency release cable housing assembly may partially dislodge the housing and engage or activate the forward and aft hook emergency release mechanism. This may cause an inadvertent release of loaded forward and aft hook assemblies in flight.**

12. Forward and aft cargo hook release lever — Check for security and stowed.
- 13. Forward, center, and aft cargo hook release lever — Check for security and stowed.
  - 13.1 **714A** DECU — Check condition and security.
- 14. ERFS installed — Check the following:
  - a. All fuel manifold lines, electrical lines, grounding cables, and vent lines to ensure that they are properly secured and connected.
  - b. Fuel manifold lines and tiedown straps for chafing. Tank tiedown straps for security.
  - c. Ensure ERFS tanks are properly fueled, **580 GALLONS MAXIMUM PER TANK**.
  - d. ERFS tanks for leakage.
- ★○ 14.1 ERFS II installed — For each installed ERFS II tank assembly check the following:
  - a. Tank Restraint Assembly — Check location and security.
  - b. Cavity Overboard Drain — Check connection and security of drain in use. Check drain not in use is capped.
  - c. Grounding Cable — Check connection security.
  - d. Vent Hose Assembly — Check connection security.
  - e. Fuel Transfer Hose Assembly — Check connection security; all Unisex valves OPEN.

**CAUTION**

**Failure to close the Unisex valves at the ERFS II tank end of the single point pressure refueling hose assembly could allow suctioning of fuel from the helicopter main fuel tanks during FARE operations.**

- f. Single Point Pressure Refueling Hose Assembly — Check connection security; Unisex valve at ERFS II Tank CLOSE.
- g. Electrical Harness — Check connection security of J1.
- h. Fuel Quantity Sensing Wiring Harness — Check connection security of J2.
- i. Fuel/Defuel Vent Valve — Check in the CLOSED position.

**WARNING**

**Failure to remove water and contaminants from the ERFS II tank sump could result in contaminants being transferred to the helicopter fuel tanks or other aircraft or equipment during FARE operations. If water and contaminants are not removed, a loss of engine power may result.**

- j. ERFS II Tank Sump Fuel Sample — Check before first flight of the day.
- k. Filler Cap — Check in place, closed, and locked.
- i. ERFS II FUEL CONTROL PANEL — Check or set as follows:
  - (a) Electrical Harness-Helicopter Receptacles to Fuel Control Panel — Check connection security of J5.
  - (b) Electrical Harness-Fuel Control Panel to Tank Assembly — Check connection security of J1, J2, and J3.
  - (c) Wiring Harness-Fuel Quantity Sensing — Check connection security of J4.
  - (d) PUMP AC circuit breaker six (6) each — Check in reset position on TANK 1, TANK 2, and TANK 3 (if installed).
  - (e) PANEL POWER circuit breaker — Check in reset position.
  - (f) PANEL LIGHTING circuit breaker — Check in reset position.
  - (g) PUMP switches — OFF on TANK 1, TANK 2, and TANK 3.
  - (h) PRESS LOW lights three (3) each — Press to test (Aircraft power must be on to illuminate).
  - (i) REFUEL VALVE — Check CLOSE.
  - (j) PANEL illumination switch/rheostat — OFF.
  - (k) FUEL QUANTITY switch — Set to 1, 2, 3, and TOTAL to check fuel quantity in each tank (Aircraft power must be on to illuminate).

**8-14. Aft Cabin.**

1. Ramp — Check.
  2. Engine fire extinguisher bottles — Check.
  3. POWER STEERING MODULE — Check pressure.
  4. FUEL VALVE #2 ENGINE — Check OPEN.
  5. FUEL VALVE CROSSFEED (right) — CLOSED.
  6. HYD SYS FILL module — Check condition, fluid level, cover secure, and valve closed.
- \* 7. APU start accumulators — Check pressures. If pressure is less than **3,000** psi, pressurize the system with the hand pump before attempting to start the APU.
  - \* 8. MAINTENANCE PANEL Check for tripped bite indicators and hydraulic fluid levels.
    - 8.1 AFT POS LIGHT switch — Set as required.
    - 9. PWR MDL CHIP BURN-OFF — Check for condition and security.
  - \* 10. Aft transmission — Check as follows:

- a. Oil level.
  - b. Filter button.
  - c. Oil cooler.
  - d. Secure doors.
11. APU—Check.
  12. EMERGENCY APU FLUID SHUT OFF VALVE—Check OPEN.
  13. COMPASS FLUX VALVE—Check.
  14. FUEL VALVE CROSSFEED (left)—Check CLOSED.
  15. FUEL VALVE #1 ENGINE—Check OPEN.
  16. Fire extinguisher—Check seal intact, DD Form 1574/1574-1 and security.

**8-15. EXTERIOR CHECK.****8-16. Aft Cabin.**

1. Position light—Check condition.
- 1.1 **714A** DECU—Check condition and security.
2. Right aft landing gear area—Check condition and security of all components as follows:
  - a. Gear support structure.
  - b. Tire.
  - c. Shock strut extension and static lock stowed.
  - d. Power steering actuator and brakes.
  - e. Fluid lines.
  - f. Electrical wiring.
  - g. Ground proximity switch and linkage.
  - h. Swivel lock.
3. Vent and fluid drain lines—Check unobstructed.
- 3.1 ERFS II Installed. Aircraft Overboard Drain Outlets—Check. Check for signs of any fuel seepage.
- 3.2 ERFS II Installed. Aircraft Overboard Vent Outlets—Check. Check for signs of excessive fuel venting.

**8-17. Right Cabin.**

1. Fuselage—Check as other items are checked.
- \*2. Fuel system—Check as required, caps secured.
3. Position light—Check condition.
4. Forward landing gear area—Check condition and security of all components as follows:
  - a. Tire.
  - b. Shock strut for extension.
  - c. Brakes.
  - d. Fluid lines.

5. Pressure refueling control panel—Check as follows:
  - a. PWR and LT switches at OFF.
  - b. Refueling receptacle cover installed and secured.
  - c. Landing gear and pressure refueling panel cover closed and secure.
6. Static port—Check unobstructed.
7. Right electrical compartment—Check condition and security.

**8-18. Forward Cabin.**

1. Heater intake, exhaust, and combustor drain—Check.
2. Pilot's jettisonable door—Check.
3. Pilot's pedal area—Check.
4. Right AFCS yaw ports—Check.
5. Pitot tubes—Check.
6. Antennas—Check.
7. Searchlights—Check.
8. Windshield and wipers—Check.
9. Left AFCS yaw ports—Check.
10. Copilot's pedal area—Check.
11. Copilot's jettisonable door—Check.

**8-19. Left Cabin.**

1. Fuselage—Check as other items are checked.
2. Left electrical compartment—Check.
3. Forward landing gear area—Check condition and security of all components as follows:
  - a. Tires.
  - b. Shock strut for extension.
  - c. Brakes.
  - d. Fluid lines.
4. Forward and aft cargo hooks—Check hooks clear and load beam closed. Electrical harness and release cable connected and dust caps stowed. If hook not installed, check for dust caps on the electrical and release cable receptacles.
5. Lower anti-collision light—Check condition.
6. Static port—Check unobstructed.
- \*7. Fuel system—Check as required, caps secure.
- 7.1 **714A** Engine wash system connectors—Check condition and security.
8. Left aft landing gear area—Check condition and security of all components as follows:
  - a. Gear support structure.
  - b. Tire.

- c. Shock strut extension and static lock stowed.
  - d. Static ground wire contacting the ground.
  - e. Fluid lines.
  - f. Electrical wiring.
  - g. Ground proximity switch and linkage.
  - h. Brakes.
  - i. Swivel lock.
9. Vent and fluid drain lines—Check unobstructed.

**8-20 Top of Fuselage.**

- \*1. No. 2 engine—Check as follows:
  - a. Inlet for foreign objects. Check condition and security of FOD screens.
  - b. Oil level and cap secure.
  - c. Cowling for security.
  - d. Tailpipe condition and security, presence of fuel, oil, and foreign objects.
- 2. Anticollision light and formation lights—Check condition.
- \*3. Aft rotor (right side)—Check blades for condition and reservoir oil levels.
- 4. Droop stop shrouds—Check condition and security. Check inspection cover closed.
- 5. Upper boost actuator—Check for extended jam indicators and exposed piston rods for cleanliness.
- ★ 6. Hydraulic compartment—Check as follows:
  - a. Condition and security of lines and coolers.
  - b. No. 2 flight control system accumulator for proper indication.
  - c. Utility reservoir pressurization accumulator for **2500 to 3500** psi charge.
- \*7. Combining transmission area—Check for foreign objects, and oil coolers for obstructions. Check filter buttons for engines and combining transmission.
- \*8. Aft rotor (left side)—Check blades for condition and reservoir oil levels.
- 9. Droop stop shrouds—Check condition and security.
- 10. Upper boost actuator—Check for extended jam indicators and exposed pistons for cleanliness.
- \*11. No. 1 engine—Check same as No. 2 engine.
- 12. Drive shaft area—Check condition and security as follows:
  - a. Drive shafts, couplings, and mounts.
  - b. Fluid lines.
  - c. Control linkage.
  - d. Foreign objects.
  - e. Drive shaft fairing.

- \*13. Forward rotor (right side)—Check same as aft rotor.
- 14. Forward transmission oil cooler inlet—Check for obstructions.
- 15. Upper boost actuators—Check for extended jam indicators and exposed pistons for cleanliness.
- 16. Forward transmission—Check for foreign objects and cooler condition.
- ★ 17. Hydraulic compartment—Check as follows:
  - a. Condition and security of lines and coolers.
  - b. No. 1 flight control system accumulator for proper indication.
- \*18. Forward rotor (left side)—Check same as aft rotor.
- 19. Brake accumulator pressure—Check **600 to 1400** psi.
- \*20. Pylon fairings, work platforms, and inspection panels—Check secure.
- 21. Top of fuselage—Check for foreign objects.

**CAUTION**

**Failure to remove fuel vent covers may cause fuel tanks to collapse while in use under certain conditions.**

- 22. Remove the fuel vent covers (3) (if installed) before using ERFS.

**\*8-21 Walk Around Check and Security Brief.**

- 1. All access doors—Check secure.
- 2. Tie down, locking devices, covers, and ground cables—Removed and secured.
- 3. Cockpit, fwd transmission, and fwd cabin area soundproofing installed—Check.

**NOTE**

The cockpit, forward transmission, flight control, and avionics compartment soundproofing should be installed during normal aircraft operation to reduce noise levels in the crew and passenger areas and to aid in venting of transmission heat and fumes.

- 4. Crew/passenger briefing—Complete as required.

**8-22 Before Starting Engines.**

- 1. Pedal adjustment—Matched. Check that yaw pedals are adjusted equally and that adjustment pins are in the same hole position. Uneven pedal adjustment can cause droop stop pounding during engine start and ground operations.
- 2. Shoulder harness locks—Check operation and leave unlocked.
- \*3. No. 1 and No. 2 PDPs—Check all circuit breakers in and gang bar up.

★ 4. Overhead switches and control panels. Set as follows:

- \*a. EXT LTG switches—As required.
- \*b. CPLT LTG switches—As required.
- c. COMPASS switch—As required.
- d. TROOP WARN switches—OFF.
- e. HTG switches—As required.
- f. W/S WIPER switch—OFF.
- g. ELECT switches—OFF.
- \*h. LTG switches—As required.
- \*i. FUEL CONTR switches—Set as follows:
  - (1) XFEED switch—OPEN.
  - (2) REFUEL STA switch—OFF.
  - (3) L MAIN FUEL PUMP switches—ON.
  - (4) All remaining FUEL PUMP switches — OFF.
- j. **712** START switches—OFF.
- k. ENG COND levers—STOP.
- \*l. **714A** FADEC switches—Check or set as follows:
  - (1) B/U PWR switch—OFF.
  - (2) LOAD SHARE switch—TRQ.
  - (3) 1 and 2 PRI/REV switches—PRI.
  - (4) NR% switch—100.
- \*m. INTR LTG switches—As required.
- \*n. PLT LTG switches—As required.
- o. ANTI-ICE switches—OFF.
- p. HOIST switches—OFF.
- q. CARGO HOOK switches—Set as follows:
  - (1) MSTR switch—OFF.
  - (2) HOOK SEL switch—As required.
  - (3) EMERG REL ALL switch—OFF. Cover down.

r. HYD switches—Set as follows:

- (1) PWR XFER switches—OFF.
  - (2) FLT CONTR switch—BOTH.
  - (3) BRK STEER switch—ON. Cover down.
  - (4) RAMP switch—ON.
  - (5) RAMP EMER switch—HOLD. Cover down.
- 5. FIRE PULL handles—In.
  - 6. AGENT DISCH switch—Check.
  - \*7. XMSN OIL PRESS switch—SCAN.
  - \*8. XMSN OIL TEMP switch—SCAN.
  - \*9. VGI switches—NORM.
  - 10. CYCLIC TRIM switch—AUTO.
  - \*11. AFCS SYSTEM SEL switch—OFF.
  - \*12. FLARE DISP switch—SAFE.
  - 13. Avionics equipment—OFF; set as required.
  - 13.1 HUD—OFF.
  - 14. **712** EMERG ENG TRIM switches—AUTO; covers down.
  - 15. SWIVEL switch—LOCK.
- 8-23 Starting Engines.**
- \* (1.) BATT switch—ON.
  - 2. CAUTION LT TEST switch—TEST. Check that all caution capsules and the two master caution lights on the instrument panel come on. Some of the caution capsules will be on before the system is checked.
  - 3. Clocks—Running, Set as required.
  - F (4.) TROOP WARN ALARM and JUMP LT—Two bells, two red, two green.
  - \*F 5. Fire guard posted—APU clear to start.



★\* ⑥ APU-Start as follows:

- a. APU switch-RUN for **3 to 5** seconds.
- b. APU switch -START for **2** seconds, then RUN.

**NOTE**

If the start is not completed, or the APU is automatically shut down, wait one minute for cooling before attempting a restart. Failure to allow the APU to cool may cause a premature shutdown on restart due to overtemperature. If the start is not completed, do not turn the BATT switch OFF. Set the APU switch to OFF, check the BITE indicators on the ESU, and record the display for maintenance.

- c. APU ON indicating light-Check on.
- d. UTIL HYD SYS caution - Check out. If the light does not go out within **30** seconds after APU ON indicating light comes on, APU switch OFF.
- \* 7. APU GEN switch-ON. NO. 1 and 2 RECT OFF and L and R FUEL PRESS caution capsules out.

**NOTE**

If either HYD FLT CONTR caution capsule does not go out in **30** seconds after the PWR XFER switches are set to ON, set PWR XFER switch to OFF. Do not fly the helicopter.

- \* 8. PWR XFER-Check
  - a. PWR XFER 1 and 2 switches- ON. Check HYD FLT CONTR caution capsules out.
  - F** b. Pressures normal.
- \***F** 9. MAINTENANCE PANEL-Check.
  - a. GND switch-TEST, then RESET.
  - O** b. GROUND CONTACT indicating lights-check on.
  - c. Systems-Normal.
- \* 10. Avionics-On as desired.
- O** 10.1 HUD-ON
- \* 11. CARGO HOOKS HOIST/WINCH-Check operation as required. Refer to Chapter 4, Section III.
- 12. SLT-FIL switches-Check and set as required.
- \* 13. PARKING BRAKE-Set.
- 14. CRUISE GUIDE indicator-Check for pointer in white test band when the CGI TEST switch is at FWD and AFT TEST.
- \* 15. Altimeters-Set and check as follows:
  - a. Barometric altimeter-Set and check.
  - b. Radar altimeter-ON and set.
- 16. FIRE DETR switch-TEST. Check fire warning lights on, release switch, and check fire warning lights out.

- \* 17. Fuel quantity-Check as required.
- \* 18. Cyclic trim indicators-Check GND position.
- \***F** 19. Rotor blades-Check position. Make sure that a rotor blade is not within **30°** of the centerline of the fuselage throughout control check.
- \* 20. AFCS SYSTEM SEL switch-Check as follows:
  - a. Select individual system and check opposite AFCS caution capsule remains on.
  - b. Select BOTH and check both AFCS caution capsules go out.
  - c. AFCS SYSTEM SEL switch-OFF.
- \* 21. Flight control travel and hydraulics-Check as follows:
  - a. Check each individual flight control hydraulic system. Check each flight control axis individually and in combination with other axes through full travel for smoothness of motion.
  - b. Check for corresponding movement of the fore and aft rotors.

**CAUTION**

**If helicopter is parked on a slope greater than 4°, longitudinal stick travel may be restricted to less than 7 inches forward (up slope) or 4 inches aft (down slope).**

- c. Check caution capsules as this check is being performed. If the flight controls are moved erratically during the control check, unusual vibrations may be felt.
- d. Check cyclic for freedom of movements in all quadrants. Check for a minimum of **7** inches forward and **4** inches aft travel.
- e. Check thrust and pedals individually through full travel for freedom of movement.
- f. FLT CONTR switch-BOTH.
- g. Position the cyclic and pedals at neutral, thrust at ground detent.
- ★ \* 21.1 **714A** DECU PRESTART BIT-Perform as follows:
  - a. B/U PWR switch-ON.
  - b. Wait until ENG FAIL caution lights go out.
  - c. ENG COND levers-GND.
- F** d. DECUs-Check displays read 88.
- 21.2 AN/ASN 149 (V) GPS-STARTUP and configure.
- 22. Avionics-Perform operational check and set as required.
- 23. **712** ENGINE BEEP TRIM switch (NO. 1 & 2)-DECREASE for **8** seconds.

\*F 24. Area-Clear for start.

**CAUTION**

The flight controls must be manned any time the helicopter is on the ground with rotors turning.

**NOTE**

Either engine may be started first.

- ★ \* (25) 712 First engine-Start as follows:
  - F a. Clear for start.
  - b. L and R FUEL PRESS LIGHTS-Check out.
  - c. ENG COND lever-STOP.
  - d. ENG START switch-MTR.

**NOTE**

If engine does not reach 15% but exceeds 10% N1 (minimum) and has reached it's maximum speed, initiate start, but monitor engine and PTIT for possible hung start and/or excessive PTIT.

- e. Motor engine to a minimum of 15% N1. Set ENG COND lever-GND; ENG START switch to START immediately.
- f. Release START switch to MTR before PTIT reaches 200°C. When N1 is 50%, set START switch to OFF. Check STARTER ON light out.
- g. Engine instruments-Check when stabilized at ground idle (N1 at 60 to 63%). Check engine oil pressure for 20 psi minimum. The engine should accelerate to ground idle speed within 45 seconds.

**CAUTION**

The N2 section of the second engine starts turning when the first engine is started; however, the lubrication system of the second engine is driven by the N1 sections which does not begin to turn until the start sequence is initiated. Delay in starting the second engine will result in excessive wear on the N2 bearing package and seal. Start the second engine within three minutes of the first.

- ★ \* (25.1) 714A First engine-Start as follows.
  - a. ENG START switch-Select engine to be started and hold until N1 accelerates to 10%, then release switch.
  - b. Engine should accelerate to ground idle (50 to 59%) within 45 seconds.
  - c. Transmission oil pressures-Check increasing.
  - d. Engine oil pressure-Check 5 psi minimum.
- ★ \* (26) Second Engine-Start by using the same method as first engine.

- 26.1 714A P3 bellow-Check as follows:
  - a. ENG 1 FADEC PRI-REV switch (started engine )-REV
  - b. FADES Caution-ON
  - c. N1-Maximum change +3%.
  - d. FADEC PRI-REV switch (started engine)-PRI.
  - e. FADEC FAIL Caution-OUT.
  - f. Repeat for ENG 2.

- \* (27) Transmission oil pressures-Check for minimum of 7 psi. There is no time limit for ground idle operation, provided there is a minimum of 7 psi oil pressure in each engine transmission.

**CAUTION**

Failure of either engine to accelerate smoothly from ground to flight may be an indication of a clutch malfunction in the engine transmission.

- \* (28) ENG COND levers-FLT. No. 1 and No.2 clear to FLT. Engine acceleration should be smooth with no surging.

**CAUTION**

Failure of either engine N1 to accelerate past 70% N1 may be an indication of a clutch malfunction in the engine transmission.

- \* 29. 712 RPRM-Set as required.

**NOTE**

Delay turning second generator on or off for two seconds. This delay will give DECU time to sample power without causing soft fault.

- \* (30) GEN 1 and 2 switches-ON 712 No. 1 & 2 GEN OFF 714A GEN 1 & 2 caution capsules out.
- \* (31) APU GEN switch-OFF.
- ★ \* (31.1) 714A DECU START BIT-Perform as follows:
  - a. ENG COND levers-Retard 5 degrees.
  - F b. DECU display-Check display reads 88.

**NOTE**

If DECU display is other than 88, shutdown engine being checked and remove all power to DECU by pulling the respective Engine PRI and REV CONT circuit breakers on the PDP. Reset the circuit breakers and repeat the engine start sequence and DECU fault monitoring check. If DECU display is other then 88 once again, shut down helicopter and refer to maintenance.

- c. ENG COND levers — FLT.
- \* (32) PWR XFER 1 and 2 switches — OFF.
- \* (33) APU switch — OFF. APU ON caution capsule out.
- \* 34. Systems — Check normal.
- \* (35) Transponder — STBY.

**8-24. Engine Ground Operation.**

- ★ (1) FUEL PUMP and XFEED — Check operation as follows:
  - a. All FUEL PUMP switches — OFF. Check L and R FUEL PRESS caution capsules should come on.
  - b. L AFT MAIN FUEL PUMP switch — ON. Check L and R FUEL PRESS caution capsule should go out. Then switch OFF.
  - c. Remaining MAIN FUEL PUMP switches — Check as in step b. above.
  - d. L AFT AUX FUEL PUMP switch — ON. Check L AUX PRESS light on overhead panel comes on, then goes out. Set pump switch to OFF.
  - e. Remaining three AUX FUEL PUMPs — Check as in step d, except check R AUX PRESS light on, then off, for R AUX FUEL PUMP switches.
- \* (2) FUEL CONTR switches — Set as follows:
  - a. All FUEL PUMP switches — ON.
- F (3) XFEED switch CLOSE — XFEEDS checked closed, light out.
- 3. VGI switches — As required.
- (4) ANTI-ICE systems — Check as required.
- F (5) PITOT switch — ON. Physically check for pitot tube and yaw port heat. Then switch OFF.
- b. W/S switches — ON. Physically check for windshield heat. Then switch OFF.
- \* (5) Flight instruments — Check as follows:
  - a. HSI compass cards — Check synchronized. Crosscheck with magnetic compass. Refer to Chapter 3, Section III.
  - b. Attitude indicators — Adjust as required.
- (6) 712 Emergency engine trim system — Check as follows:
  - a. EMERG ENG TRIM 1 switch — DECR momentarily. Check torque and N1 de-

- crease then release. Torque and N1 should return to normal settings.
- b. EMERG ENG TRIM 2 switch — Check same as No. 1 engine.

- ★ (6.1) 714A FADEC Reversionary system — Check (First flight of day).
  - a. FADEC 1 and 2 PRI-REV switches — PRI.
  - b. NR% switch — 100%.
  - c. FADEC 1 — Check as follows:
    - (1) FADEC 1 PRI-REV switch — REV.
    - (2) FADEC 1 INC-DEC switch — DEC. Check for decrease in No. 1 engine N1 and torque, and corresponding increase in No. 2 engine N1 and torque.
    - (3) FADEC 1 INC-DEC switch — INC. Check for increase in No. 1 engine N1 and torque, and corresponding decrease in No. 2 engine N1 and torque.
    - (4) FADEC 1 PRI-REV switch — PRI.
  - f. Repeat check for FADEC 2.
- 7. Radar altimeters — Check IAW paragraph 2-200.
- (8) Transponder — Check and set.
- 9. Navigation Set DGNS — Perform operational check, confirm waypoint entry and SAS/AS as required.

**\*8-25. Before Taxi.**

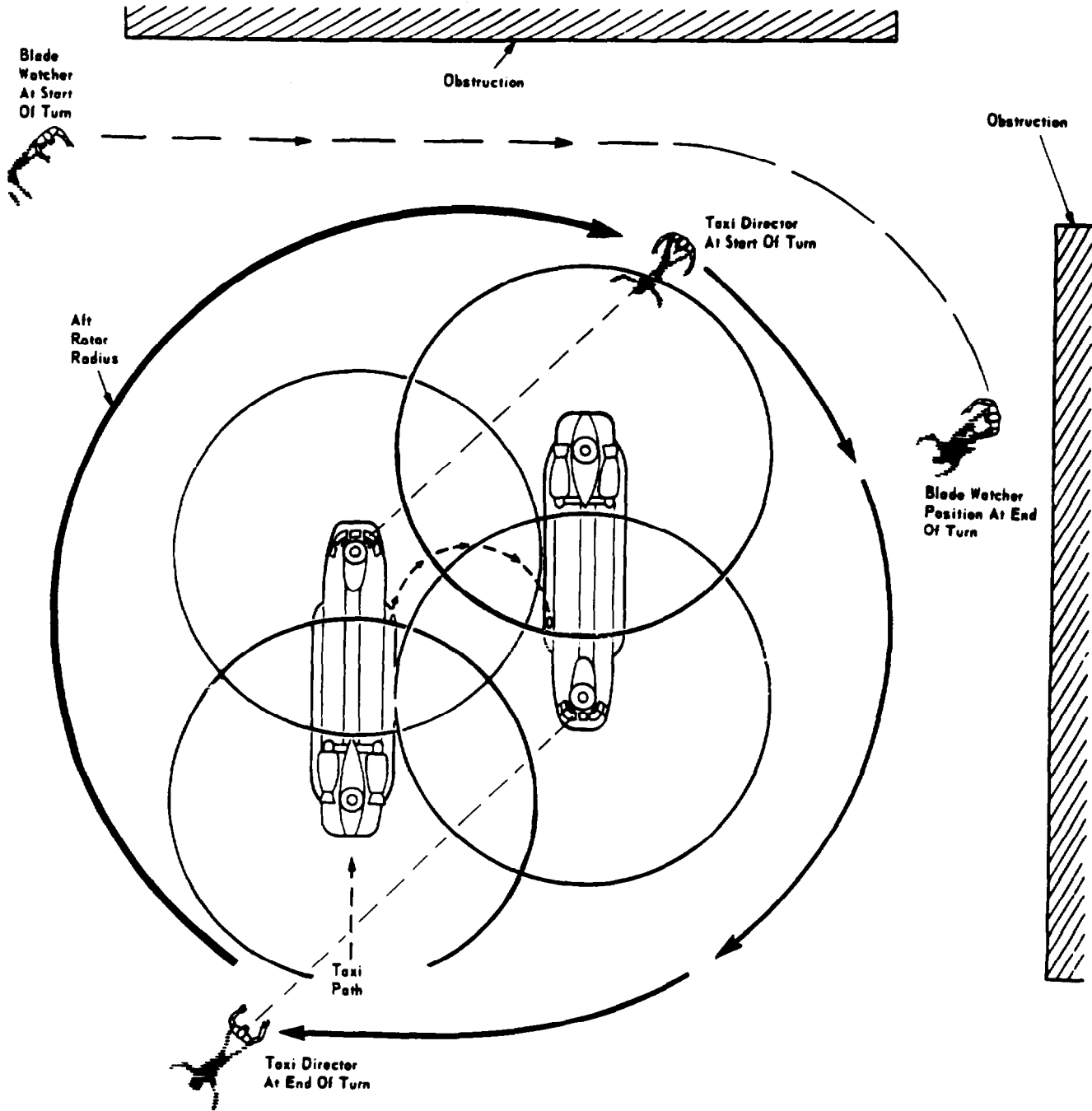
**WARNING**

**Personnel injury or death may occur and damage to airframe and rotor systems will occur if the forward or aft rotor head rotor blade droop stop(s) are missing or interposer block(s) on the aft rotor head are not engaged. After engine run-up and before flight, or shutdown if flight is not conducted, the flight engineer will scan the ground in the immediate area of the aircraft for evidence of detached droop stops.**

**CAUTION**

**To prevent damage to the cargo hooks and structure, do not ground taxi over rough or uneven terrain with the forward and aft cargo hooks installed.**

- (1) SWIVEL switch — As required.
- (2) AFCS switch — As required.



NOTES:

1. AVOID TURNING OR MANEUVERING NEAR OBSTRUCTIONS WHEN LESS THAN 75 FEET WILL EXIST BETWEEN CENTERLINE OF THE HELICOPTER AND THE OBSTRUCTIONS.
2. IF NECESSARY TO TAXI WHEN LESS THAN 75 FEET CLEARANCE EXISTS BETWEEN THE CENTERLINE OF THE HELICOPTER AND OBSTRUCTION, USE TAXI

DIRECTORS AND BLADE WATCHERS FAMILIAR WITH CH-47 TURNING CHARACTERISTICS.

3. THE BLADE WATCHER SHALL POSITION HIMSELF SO HE HAS A CLEAR VIEW OF THE ROTOR BLADES AND ANY OBSTRUCTIONS. AND THE TAXI DIRECTOR.
4. USE STANDARD HAND SIGNALS. REFER TO TM 1-1500-204-24.



Figure 8-1. Taxi Director and Blade Watcher Positions

A73437

- 3. Cyclic trim indicators — Check GND position.
- 3.1 HUD — Adjust brightness, mode, barometric altitude, pitch, and roll as necessary.
- FO** 4. Flare dispenser safety pin — Remove and stow.
- F** 5. Chocks — Removed and secured.
- F** 6. Ramp and cabin door — As required.
- F** 7. Crew, passengers, and mission equipment — Check ready for taxi.
- F** 8. Taxi director and blade watchers — Positioned as required (fig. 8-1).
- 9. PARKING BRAKE — As required.

**\*8-26. Taxiing.** Refer to TC 1-216 Aircrew Training Manual, (ATM).

- 1. Brakes — Check pilot's and copilot's as required.
- 2. Power steering — Check as required.

**8-27. Before Hover.**

- \* 1. SWIVEL switch — LOCK.
- \* 2. AFCS control panel — Set as follows:
  - a. AFCS SYSTEM SEL switch — BOTH.
  - b. CYCLIC TRIM switch — AUTO.
- 3. **712** Health Indicator Test (HIT) check. Perform as required.

**NOTE**

The PAC check may be deferred to the hover check.

- 3.1 **714A** Power Assurance Check (PAC) — Perform first flight of day:
  - a. NR% switch — 100%.
  - b. ENG 1 ENG COND lever — Adjust.
  - c. THRUST CONT lever — Raise until TRQ reads 60% to 80%. Stabilize for 30 seconds.
- F** d. TEST switch ENG 2 — PWR ASSURANCE. Check DECU display. Compare displayed value with PAT Trigger Value.
- e. ENG 1 ENG COND lever — FLT.
- f. Repeat check with ENG 2 ENG COND lever.
- g. THRUST CONT lever — Adjust.
- \* 4. RRPM — Set as required.

**8-28. Hover Check.** Perform the following check at a hover:

1. Flight controls — Check flight controls for correct response.
2. Systems instruments — Check normal.
3. Flight instruments — Check as required.
  - a. VSI, barometric and radar altimeters — indicate climb and descent.
  - b. Turn pointers, heading indicators and magnetic compass—Indicate turns right and left.
  - c. Slip indicator — Ball free in race.
  - d. Attitude indicator — Indicate nose high, nose low, banks left and right.

**NOTE**

Rapid rotation of the pitch and roll trim knobs on the attitude indicator may cause abrupt pitch and roll attitude changes with AFCS on.

- e. Airspeed indicator — Check.
- FO** 4. GROUND CONTACT indicating lights check —Both off.
5. AFCS — Check as follows: (First flight of day).
  - a. SYSTEM SEL switch — NO. 1. Check helicopter stable with no abrupt engagement error. Check NO. 2 AFCS OFF caution on.
  - b. SYSTEM SEL switch —NO. 2. Check helicopter stable with no abrupt engagement error. Check NO. 1 AFCS OFF caution on.
  - c. SYSTEM SEL switch — Both. Check helicopter stabled with no abrupt engagement error. Check both AFCS OFF caution capsules extinguished.
6. Power — Check. Note torque and N1.

**★ 8-29. Before Takeoff.**

1. Systems — Check indications of the following:
  - a. Rotor — Check as required.
  - b. Torque.
  - c. Engine.
  - d. Transmission.
  - e. Fuel.
  - f. **712** Master caution panel.
  - g. **714A** Caution/Advisory panel.
2. PARKING BRAKE As required.
3. AFCS SYSTEM SEL switch — As required.
4. CYCLIC TRIM switch — Check.
5. SWIVEL switch — LOCK.
6. Transponder— As required.
- F** 7. Crew, passengers, and mission equipment — Check.

**8-30. Normal Takeoff.** Refer to TC 1-216 Aircrew Training Manual (ATM).

**8-31. Hover** Refer to TC 1-216 Aircrew Training Manual (ATM).

To engage radar altitude hold perform the following:

**WARNING**

**Do not use radar altitude hold in forward flight over terrain. It may not provide adequate terrain clearance in rapidly changing terrain. Use radar altitude hold to maintain a constant absolute altitude during hover or forward flight over water. RAD ALT hold can be used to a maximum of 1,500 feet absolute altitude.**

- a. Radar altimeter — ON. Check that pointer has rotated from behind the mask, the digital display is lit, and the OFF flag is out of view.
- b. Fly to desired altitude.
- c. RAD ALT select on AFCS panel — Press. Check ENGAGED light ON. The radar altitude hold feature of the AFCS will maintain a constant altitude.
- d. To select another altitude press the THRUST CONT BRAKE TRIGGER. Fly to desired altitude and release the THRUST CONT BRAKE TRIGGER. The altitude at the moment the trigger is released will be the new altitude.

**Takeoff over water.** Takeoff over water is begun from a hover height of approximately 30 feet.

Align the helicopter with the desired takeoff course at a stabilized hover of approximately 30 feet, or an altitude permitting safe obstacle clearance. Smoothly apply forward cyclic pressure to level the helicopter and begin acceleration

## TM 55-1520-240-10

into effective translational lift (ETL). Control rate of acceleration and direction of flight with cyclic and altitude with thrust. As the aircraft accelerates through ETL, establish a pitch attitude and apply thrust that will result in a simultaneous gain in altitude and airspeed. Continuous coordinated application of control pressures is necessary to maintain trim, heading, flight path, airspeed, and rate of climb.

**8-32. Maximum Performance Takeoff.** A takeoff that demands maximum performance from the aircraft may be necessary because of various combinations of heavy aircraft loads, restricted performance due to high density altitudes, barriers that must be cleared, and other terrain features. The decision to use either of the following takeoff techniques must be based on an evaluation of the conditions and aircraft performance.

a. *Coordinated Climb Takeoff.* Align the helicopter with the chosen takeoff course at a stabilized hover of approximately 10 feet. Apply forward cyclic pressure smoothly and gradually while simultaneously increasing thrust to begin a coordinated acceleration and climb. The climb may be made vertical with appropriate adjustment of the cyclic control. Maximum torque available should be applied as the aircraft attitude is established that will permit safe obstacle clearance. The climbout is continued at that attitude and power setting until the obstacle is cleared. After the obstacle is cleared, adjust aircraft attitude and thrust as required to establish a climb at the desired rate and airspeed. Continuous coordinated application of control pressures is necessary to maintain trim, heading, flight path, airspeed, and rate of climb. Takeoff may be made from the ground by positioning the cyclic control in neutral, prior to increasing thrust. Takeoff over water is begun from a hover height of approximately 30 feet and continued as above.

b. *Level Acceleration Takeoff.* Align the helicopter with the chosen takeoff course at a stabilized hover of approximately 10 feet. Apply forward cyclic pressure smoothly and gradually while simultaneously increasing thrust to begin accelerating at approximately 10 feet. Maximum torque available should be applied prior to accelerating through ETL. Adjust cyclic stick to maintain desired pitch attitude throughout acceleration to climb airspeed. Approximately 5 knots prior to reaching the selected climb airspeed, gradually release forward cyclic pressure and allow the aircraft to begin a constant airspeed climb to clear the obstacle. Care must be taken not to decrease airspeed during the climbout since this may result in the helicopter descending (falling through). After the obstacle is cleared, adjust aircraft attitude and thrust as required to establish a climb at the desired rate and airspeed. Continuous coordinated application of control pressures is necessary to maintain trim, heading, flight path, airspeed, and rate of climb. Takeoff may be made from the ground by positioning the cyclic control in neutral prior to increasing thrust.

Takeoff over water is begun from a hover height of approximately 30 feet and continued as above.

### **8-33. Slingload.**

Refer To TC 1-2 16 Aircrew Training Manual (ATM).

### **8-34. Climb.**

Refer to chapter 7 for recommended airspeeds, power settings, and fuel flow.

## **8-35. Cruise Check.**

1. Fuel Consumption — Check.
2. HDG select — As required. Perform the following:
  - a. Rotate HDG knob on the HSI that is to be used for the referenced heading until the cursor (bug) is aligned with chosen heading.
  - b. Trim helicopter straight and level (center ball on turn and slip indicator) and trim forces (depress CENTERING DEVICE RELEASE).
  - c. CMD SEL switch on HSI MODE SELECT panel — Press. Check switch is depressed and SEL legend is lit.
  - d. AFCS HDG — Press. Check ENGAGED light on. The helicopter will now turn to and capture the heading.
  - e. Heading can be changed by rotating the cursor (bug) to the new heading. The helicopter will then turn to the new heading.
  - f. Cabin door escape panel — Assure that airspeed is less than 100 KIAS before closing door in flight.

### **NOTE**

Pressing either CENTERING DEVICE RELEASE switch disengages heading select operations

### **CAUTION**

**Radar altitude (RAD ALT) hold can only be used in forward flight overwater, it cannot be used in forward flight over terrain.**

### **CAUTION**

**Large pitch inputs will result in rapid gain or loss of altitude. If altitude hold is on, an over-torque condition can occur during large pitch-down inputs. Monitor thrust control movement and torquemeter during airspeed changes. Also, when operating with altitude hold, limit bank angles to 45 degrees maximum. An excessive bank angle may result in an altitude loss, and if operating at a high gross weight, an overtorque condition.**

3. BARO/RAD altitude hold — As required. Altitude hold is selected to hold a constant altitude.
  - a. When at chosen cruise altitude and airspeed, press BARO (RAD) ALT switch on AFCS control panel. Check that ENGAGED light is ON. The helicopter will now maintain the selected altitude.
  - b. To change altitude, press the THRUST CONT BRAKE TRIGGER. Fly the helicopter to the desired altitude, then release the THRUST CONT BRAKE TRIGGER. The helicopter will remain at the altitude at which the trigger was released.

- F 4. Ramp area — The ramp area must be checked every 30 minutes of flight. (Refer to section I, Crew Duties.)

**8-36. DESCENT.**

Refer to Chapter 7 for power requirements at selected airspeeds and rates of descent.

★ **8-37. Before Landing.**

The following checks must be accomplished prior to landing

1. Systems — Check indications of the following:
  - a. Rotor.
  - b. Torque.
  - c. Engine.
  - d. Transmission.
  - e. Fuel.
  - f. 712 Master caution panel.
  - g. 714A Caution/Advisory Panel.
2. PARKING BRAKE — As required.
3. AFCS control panel — Check as follows:
  - a. AFCS HDG and ALT switches as required.
  - b. CYLIC TRIM switch as required.
  - c. AFCS selector switch as required.

- F 4. Crew, passengers, and mission equipment-Check.

**8-38. LANDING.**

Refer to FC1-2I6, Aircrew Training Manual (ATM).

**8-39. Landing From a Hover to Water.** Prior to landing, the PITOT HEAT switch must be ON. The ramp, lower half cabin door, lower rescue door, and drain plugs must be closed. Landing/searchlights shall be retracted. From a stabilized hover, decrease thrust for a smooth rate of descent. A vertical descent, rather than a descent with some forward movement, will tend to disperse the swirling water spray under a no-wind condition. As the aft wheels and then the fuselage near the water, continue to lower, the thrust control to ground detent. As more of the fuselage enters the water, buoyancy will level the helicopter attitude.

**NOTE**

Aft landing gear ground proximity switches are not actuated during a water landing. Therefore, longitudinal cyclic pitch actuators must be manually set to ground position.

**CAUTION**

**If contact is made with floating debris, return to hover and assess damage.**

As the attitude approaches level, the helicopter will start moving forward and stabilize at approximately 4 to 5 knots. This speed will be attained with the controls in neutral and the thrust control at the ground detent. The water level will

not vary significantly because of GW or CG. As observed from the cockpit, the water level will appear to intersect the fuselage below the lower nose enclosure.

**8-40. Running Landing to Water.** Running landings can be performed within the limitations shown in chapter 5., but should only be performed during training missions, actual single-engine conditions when a hovering approach is not possible, or when atmospheric conditions dictate. Running landings for training should only be performed to calm water (Sea State 1 or less).

Prior to performing a running landing to the water, the PITOT HEAT switch must be ON. The ramp, lower half of cabin door, lower rescue door, and drain plugs must be closed. Landing/searchlights shall be retracted. The approach is shallow, and flown at an airspeed that provides safe aircraft control. Prior to water entry, it may be necessary to use the windshield wipers. Entry of the aft wheels into the water is easily recognized because the helicopter will decelerate noticeably. Touchdown attitude should be held constant until the apparent water speed has decreased below 10 knots. At or below 10 knots, the nose can be lowered to the water by lowering the thrust control rod and neutralizing the cyclic stick. A 4- to 5-knot forward speed will result when the helicopter is level and the controls are neutralized with the thrust control at the ground detent.

**NOTE**

Aft landing gear ground proximity switches are not actuated during a water landing. Therefore, longitudinal cyclic pitch actuators must be manually set to ground position.

When the helicopter is in the water, two-way communication is lost on system whose antennas are submerged. The HF radio can be operated.

**8-41. After Landing.**

1. AFCS SYSTEM SEL switch — As required.
2. SWIVEL switch — As required.
3. Transponder — As required.
4. ANTI-ICE switches — OFF.
- FO 5. GROUND CONTACT lights check — both on.
6. Cyclic trim indicators — Check GND indication.

**8-42. Engine Shutdown.**

**CAUTION**

**Critical flight control components can be damaged if thrust is not in ground detent.**

1. Flight Controls — Neutralize. Position the pedals and cyclic at neutral and the thrust at the ground detent. Start 2 minutes engine cool-down run when the THRUST CONT lever is in the detent position and the engine temperatures have stabilized.



- 2. PARKING BRAKE — Set.
- ③ HTG switches — OFF.
- ④ SLT-FIL switches — OFF and stow as required.
- ⑤ AFCS SYSTEM SEL switch — OFF.
- F 6. Ramp — As required.
- F 7. Wheels — Chocked.
- F 8. Mission equipment — Safe as required.
- F 9. Fire guard — Posted.
- ★⑩ APU — Start. For APU starting procedures, refer to paragraph 8-23.
- ⑪ APU GEN switch — ON.
- ⑫ GEN 1 and 2 switches — OFF.
- ⑬ PWR XFER 1 and 2 switches — ON.
- 14. Cyclic trim indicators — Check GND position, manually program if necessary.

**WARNING**

Personnel injury or death may occur and damage to the airframe and rotor systems will occur if the forward or aft rotor head rotor blade droop stop(s) are missing or interposer block(s) on the aft rotor head are not engaged. After engine run-up and before flight, or shut down if flight is not conducted, the flight engineer will scan the ground in the immediate area of the aircraft for evidence of detached droop stops. Prior to moving engine condition levers (ECL) from ground to stop, flight engineer will, to the best extent possible, determine if the interposer blocks on the aft rotor head are in position and that all forward and aft droop stops are attached. If an interposer block or droop stop are not in place, the flight engineer will notify the pilot in command. All non-crewmembers will evacuate aircraft to a safe location. If possible, crew will contact maintenance and attempt to engage interposer block with high pressure water stream or prepare aircraft for shutdown in such a way as to minimize damage to aircraft and components and prevent injury to personnel. If interposer blocks appear to be in place and no droop stops are missing, the flight engineer will clear the pilot to shut-down the first engine. After the first engine is shut down, the flight engineer will ob-

serve the rotor tip path of the forward and aft rotor heads. A rotor blade drooping significantly lower than the other blades indicates a missing droop stop. In this case the remaining running engine's ECL should be advanced until sufficient rotor RPM is achieved to lift rotor blades off the stops to insure no blade contact with airframe and maintenance is contacted to prepare aircraft for an emergency shut-down that will minimize damage to the aircraft and injury to personnel.

**NOTE**

Aft landing gear ground proximity switches are not actuated during a water landing. Therefore, longitudinal cyclic pitch actuators must be manually set to ground position prior to engine shutdown on the water.

- ⑮ ENG COND levers — GND, run engines at GND for 2 minutes.
- ⑯ FUEL CONTR switches — Set as follows:
  - a. XFEED switch — CLOSE.
  - b. FUEL PUMP switches — OFF.
  - c. REFUEL STA switch — As required.

**WARNING**

Personnel injury or death may occur and damage to the airframe and rotor systems will occur if the forward or aft rotor head rotor blade droop stop(s) are missing or the interposer blocks on the aft rotor head are not engaged. Prior to moving engine condition levers (ECL) from ground to stop, the flight engineer will, to the best extent possible, determine if the interposer blocks on the aft rotor head are in position and that all forward and aft droop stops are attached. If an interposer block or droop stop is not in place, the flight engineer will notify the pilot in command. If interposer blocks appear to be in place and no droop stops missing, the flight engineer will clear the pilot to shut down the first engine. After the first engine is shut down, the flight engineer will observe the rotor tip path of the forward and aft rotor heads. A rotor blade drooping significantly lower than the other blades indicates a missing droop stop.

- ⑰ ENG COND levers — STOP.

**NOTE**

Monitor temperatures during shutdown. If temperatures rise above **350°C**, motor engine immediately until temperature decreases below **260°C**. Both engines cannot be motored at the same time.

- F★\*** (17.1) **714A** DECU SHUTDOWN BIT — Check displays read 88.

**NOTE**

If DECU display is other than 88, advance respective ECL to GND without starting engines. If 88 is displayed, then a nuisance fault has been verified. If other than 88 is displayed, refer to maintenance.

- 18. Avionics — OFF.
- O** 18.1 HUD — OFF.
- 19. Radar altimeters — OFF.
- F** 20. MAINTENANCE PANEL — Check record any bite indications on DA Form 2408-13.
- 21. PWR XFER 1 and 2 switches — OFF after rotors have stopped.
- 21.1 **714A** FADEC B/U PWR — OFF.
- 22. APU GEN switch — OFF.
- 23. APU switch — OFF. The APU may be shut down after the rotors have stopped and there is no further need to motor the engines.
- 24. Light switches — OFF as required.
- 25. BATT switch — OFF.

- 26. Ignition lock switch — OFF, key removed as required.
- 27. EMERGENCY POWER panel — Check flag indicators for tripped position.

**8-43. Before Leaving Helicopter.**

- 1. Walk-around inspection — Perform. Checking for damage, fluid leaks and levels.
- F** 2. Check the following:
  - a. Fluid levels.
  - b. Bypass indicators and filter buttons.
  - c. Jam indicators.
  - d. Cabin and mission equipment secured.
  - e. Tiedowns, grounding cables, and covers.
- 3. Complete all forms and records.
- 4. Helicopter — Secure as required.

**8-44. Instrument Flight — General.**

This aircraft is qualified for operation in instrument meteorological conditions.

**8-45. Instrument Flight Procedures.** Refer to FM 1-240, FM 1-230, FLIP, AR 95-1, FAR Part 91, and procedures described in this manual.

**8-46. Night Flying.**

Refer to FM 1-204, Night Flight Techniques and Procedures.

## SECTION III FLIGHT CHARACTERISTICS

### 8-47. GENERAL.

The flight characteristics of the helicopter throughout the flight envelope and at all gross weights are good. The flight characteristics remain essentially the same throughout the CG and GW range. There is no marked degradation of flying qualities as altitude increases.

### 8-48. AFCS Off Flight Characteristics.

The AFCS is required to provide the helicopter with adequate stability. Therefore, the stability of the helicopter will be reduced when operating with AFCS off. With practice, the pilot will know in advance what to expect and should have little trouble controlling the helicopter as long as established limitations (refer to Chapter 5) and certain techniques are adhered to. In general, the AFCS off flight characteristics are enhanced by spoilers on the forward pylon, strakes on the fuel pods and ramp, and a blunted aft pylon. The AFCS may be turned off at any airspeed and turned back on at or near the turn-off airspeed. If airspeed at turn-on is different from that at turn-off, a low rate pitch transient accompanied by momentary illumination of the AFCS OFF caution capsules may occur. These symptoms indicate that a DASH error signal existed a turn-on and that the DASH actuator is running at a reduced rate to cancel the error signal. When the cautions are extinguished, the error signal is cancelled, and normal DASH operation has resumed. During this period, when the error signal is being cancelled, the remaining AFCS features function normally. AFCS off flight will not be difficult when the following techniques are used:

- Maintain airspeed below established limits.
- Enter all maneuvers smoothly, keep control movements coordinated and avoid overcontrol.
- Consistently scan the turn-and-slip indicator to maintain trim flight.
- React positively but smoothly to divergent movements.

### 8-49. CENTER HOOK LOADS.

In general, the helicopter possesses excellent flight characteristics when performing an external load mission. The combination of power available, the load carried beneath the CG, and the design of the cargo hook system make loads of minimum or maximum weight relatively easy to carry and handle safely. The type loads carried can usually be broken down into three major groups: low density, high density, and aerodynamic. Each type load mentioned displays characteristics all its own and therefore must be discussed separately.

#### CAUTION

**Do not lift or rotate the center cargo hook into the cabin area or allow the mid hook to lay on the cargo floor or access door panel during inspection or use. The excessive tension placed on the triple emergency release cable housing assembly may**

**partially dislodge the housing and engage or activate the forward and aft hook emergency release mechanism. This may cause an inadvertent release of loaded forward and aft hook assemblies in flight.**

#### CAUTION

**External loads must not be rigged entirely with steel cable (wire rope) slings. To dampen vibration tendencies, a nylon vertical riser at least 6 feet long must be placed between the steel cable sling and the nylon loop or metal shackle which attaches to the cargo hook. Nylon and chain leg slings and pure nylon slings must have at least 6 feet of nylon in each leg.**

#### CAUTION

**When combination internal and external loads are carried during the same flight and the external load exceeds 12,000 pounds, position the internal load forward of the utility hatch. This procedure will preclude encountering an excessively aft CG.**

**8-50. Low Density Loads** When carrying low density loads, airspeed is limited by the amount of clearance which can be maintained between the load and the underside of the helicopter since the load will tend to trail aft as speed is increased.

**8-51. High Density Loads.** High density loads can usually be flown at cruise airspeed and in some cases up to  $V_{ne}$ , depending on the configuration of the load, air turbulence, or accompanying vibration.

**8-52. Aerodynamic Loads.** Aerodynamic loads, such as tow targets, drones, light aircraft, aircraft parts, wings, and tail sections have certain inherent dangers because of their aerodynamic lift capabilities. Therefore, the lift capabilities of external loads must be eliminated before they are lifted. Airspeed and bank angles will be governed by the reaction of the load to the airspeed. Drogue chutes shall also be used to streamline the load. However, the chute must be attached to the load with a swivel fitting.

**8-53. Multi-Hook Loads.** Handling characteristics are improved when loads are slung using two-point (forward and aft hook) sling suspension. Load motion is substantially reduced. Potentially unstable loads are directionally restrained by two-point suspension; airspeed capability is increased above the airspeed for single-point suspension. When low-density high-drag cargo is carried, the risk of single-hook failure in a two-point suspension is reduced by the addition of a safety sling from the center hook to the forward load attachment point. The multi-hook configuration also enables the carrying of three independent loads within the CG limit.

## SECTION IV ADVERSE ENVIRONMENTAL CONDITIONS

### 8-54. COLD WEATHER OPERATION.

Refer to FM 1-202, Environmental Flight.

**8-55. General.** Operating the helicopter in an environment of extreme low temperature and the associated weather phenomena requires that certain techniques and operating procedures be implemented in addition to the normal operating procedures in section II. The following operating techniques and procedures have been developed from actual arctic flight testing and other pertinent information.

**8-56. Preparation for Flight.** The following additional exterior checks are to be performed during cold weather operation.

a. Check that ail ice, snow, and frost have been removed from the exterior surfaces, particularly the rotor blades.

#### **CAUTION**

**Ice removal should never be accomplished by chipping or scraping. Deicing fluid should be used.**

b. Landing gear shock struts, wheel brakes and flight control system actuators should be checked to make certain that exposed piston areas are free of dirt, ice, etc.

c. While checking the engines, the compressor should be manually checked for freedom of rotation. Heat must be applied if the compressor is frozen.

d. When operating the ramp, it maybe necessary to cycle it once or twice to achieve proper closure.

e. Ensure that the manually operated vent valves on the rotary-wing shock absorbers are open at temperatures below **-18°C**. At temperatures between **-18°C** and **-1°C**, the vent valves may be open or closed. At temperatures above **-1°C**, the vent valves must be closed.

f. If seasonal temperatures are **+4°C** and below, the aft rotor droop stop shrouds should be installed.

g. At temperatures below **-18°C**, preheating aircraft is recommended for a minimum of **1-1/2** hours. Emphasis should be placed on engine fuel control units.

h. Refer to Chapter 5 for icing limitations.

### 8-57. Heater Operation.

### 8-58. Normal Operation - Heating and Ventilating System.

#### **CAUTION**

**Cycling of the heater blower may disable power steering control.**

#### a. Starting.

- (1) Inlet and outlet covers - Remove.
- (2) BATT switch - ON
- (3) APU - Start (para. 8-23).
- (4) APU GEN switch – ON. RECT OFF caution capsule extinguishes.
- (5) R (right) MAIN FUEL PUMP switches - ON.

#### **CAUTION**

**Pull out the cockpit air knobs slowly to preclude dirt and debris from being blasted into the air and the pilot's eyes.**

- (6) Push in the air control knobs.
- (7) Heater function switch – As desired (BLWR ONLY or HTR ON).
- (8) HTR START switch – Press.

#### **NOTE**

If the left side of the helicopter is exposed to the sun, the cabin thermostat may be heated to **34°C** which is sufficient to prevent starting the heater.

- (9) CABIN TEMP SEL switch – As desired.

#### b. Heat Distribution.

- (1) For maximum cockpit heat proceed as follows:
  - (a) Pilot and copilot cockpit air control knobs - Pull.
  - (b) DEFOG OR DEFROST handle - Pull.
  - (c) CABIN AIR handle – Push.
  - (d) CABIN TEMP SEL switch – Full clockwise.
- (2) For maximum cabin heat proceed as follows:
  - (a) Pilot and copilot air control knobs - Push.

- (b) DEFOG OR DEFROST handle – Push.
- (c) CABIN AIR handle – Pull.
- (d) Cabin adjustable outlets – Full open.
- (e) CABIN TEMP SEL switch – Full clockwise.

c. Stopping.

- (1) Heater function switch – OFF.
- (2) Wait **two** minutes before turning generator(s) off.
- (3) After heating and ventilating system has been stopped with the APU GEN ON, the blower will continue to operate until the temperature within the heater combustion chamber is **below 49°C**.

### 8-59. Alternate Operation - Heating and Ventilating System.

The following paragraphs describe heating and ventilating system failure modes.

**8-60. Vibrator Contact Failure.** The heater may be equipped with either a solid-state vibrator or an electromechanical vibrator. The electromechanical vibrators may experience vibrator contact failure, which will result in failure of the heater to operate. Heaters equipped with electromechanical vibrators are identified by a rotary selector switch on the heater junction box. The electromechanical vibrator is equipped with two separate sets of contacts designated NORMAL and RESERVE. Upon failure of the normal contacts, the reserve set may be brought into operation by placing the switch on the junction box to RESERVE. The junction box is on the ignition unit next to the heater.

**8-61. Heater Overheat Condition.** If the HEATER HOT caution illuminates, proceed as follows:

#### CAUTION

The heater function switch shall remain ON while performing steps a. through c.

- a. Wait **two** minutes for cooldown.
- b. HTR START switch – Press.
- c. HEATER HOT caution – Monitor. The HEATER HOT caution will not extinguish until combustion chamber temperature is **below 177°C** and the HTR START switch is pressed.

**8-62. Engine Starting.** No special cold weather start procedures are required.

**8-63. Warmup and Ground Tests.** Allow the engine and transmission oil pressures and temperatures to stabilize prior to takeoff. This will require several minutes of operation at FLT.

To prevent unnecessary scratches, allow electrical windshield heating to completely soften frost, snow, or ice before using the windshield wipers.

**8-64. Taxiing.** Difficulty will be encountered when taxiing on ice and snow covered surfaces where braking action is poor. Taxiing on the aft gear (front wheels off the ground) is recommended; however, caution should be taken because of the poor visibility resulting from blowing snow.

**8-65. Takeoff.** No unusual problems are associated with either the hovering, rolling, or vertical-type takeoffs other than the effects of blowing snow and slippery surfaces. Depending on the weight of snow and ice accumulated on or in the fuselage, takeoff and overall performance can be seriously affected.

**8-66. During Flight.** Initial hovering with cold hydraulic fluid may produce insensitive control inputs. Hovering above 10 feet (aft wheel clearance) is recommended under these conditions until operation is normal. With AFCS on, light pitch and roll oscillations can be expected during the first 10 or 20 minutes of flight.

**8-67. Descent.** No unusual problems are encountered during a descent. Use windshield heat if necessary.

**8-68. Landing in Snow.** Landing in loose snow from a hover presents the unusual problem of low visibility caused by blowing snow. This helicopter does not produce this effect to any greater extent than other helicopters; however, caution should be exercised during this type landing.

**8-69. After Landing.** Maneuvering the helicopter into a slippery parking area may be difficult to accomplish and towing may be necessary. Taxiing on the aft gear should not be used to position the helicopter among other parked aircraft.

**8-70. Engine Shutdown.** No unusual problems are encountered during engine shutdown as long as the procedures in section II are adhered to.

**8-71. Before Leaving Helicopter.** If the helicopter is to be parked outside for extended periods, maintenance personnel should install all protective covers and secure the rotor blades. When ambient temperatures of  $-18^{\circ}\text{C}$  and below are expected and the helicopter is to be parked outside, maintenance personnel should also remove the battery and store it in a warm area until required for further operation.

### 8-72. DESERT AND HOT WEATHER OPERATION.

Refer to FM 1-202, Environmental Flight.

**8-73. General.** The reduction in power available and the resulting decrease in helicopter performance caused by reduced air density is the main consideration during desert and hot weather operation. Therefore, greater emphasis must be placed on determining performance during mission planning.

**8-74. Preparation for Flight.** A normal preflight inspection is to be conducted as described in section II. Extra emphasis should be placed on equipment which may be affected by higher temperatures, such as tires,

seals, and hydraulic components. In addition, check equipment for signs of deterioration or excessive abrasion from blowing dust or sand. Windows and doors should be opened to provide increased ventilation.

**8-75. Engine Starting.** The normal engine starting procedures in section 11 are to be used.

**8-76. Taxiing.** Braking should be kept to a minimum to prevent overheating. Ground operation in general should be kept to a minimum.

**8-77. Takeoff, Climb, Cruise, and Descent.** Helicopter performance may be reduced; therefore, techniques should be adjusted accordingly,

**8-78. Landing.** The landing procedures in section II apply. Braking should be kept to a minimum to prevent overheating.

**8-79. Engine Shutdown.** It maybe necessary to motor the engines if temperature does not decrease below 350°C. It may not be possible to lower the temperature to 260°C. If the temperature will not decrease below 260°C, terminate motoring when the temperature indication stabilizes.

#### NOTE

Pilots should make an attempt to avoid motoring periods in excess of 15 seconds.

**8-80. Before Leaving the Aircraft.** Leave all windows and doors open to increase ventilation, except during conditions of blowing dust or sand.

#### 8-81. TURBULENCE AND THUNDERSTORM OPERATION.

**8-82. Prior to Entering Turbulent Air.**

#### CAUTION

**To prevent engine overtorque, do not enter forecast moderate or stronger turbulence with the thrust brake (portion of the CCDA) inoperative or BARO ALT engaged.**

Prior to entering moderate or stronger turbulent air, the following should be accomplished:

1. BARO ALT switch – Disengaged.
2. Crew – Alert.
3. Airspeed – Adjust as follows:
  - a. In **severe** turbulence, **decrease** airspeed to **Vne minus 15** knots or to maximum range, whichever is slower. (Refer to chapter 7.)
  - b. In **moderate** turbulence, **decrease** airspeed to **Vne minus 10** knots or to maximum range, whichever is slower. (Refer to chapter 7.)
4. Longitudinal cyclic trim – Select MAN, then adjust both actuators for the airspeed to be

flown. This is accomplished to prevent the cyclic trim actuators from cycling.

5. Loose equipment – Secure.

6. Safety belts and shoulder harnesses – Tighten.

**8-83. In Turbulent Air.** The thrust control position, when adjusted for the airspeeds mentioned above, should be maintained and the attitude indicator should be used as the primary pitch instrument. The altimeter and vertical velocity indicator may vary excessively in turbulence and should not be relied upon. Airspeed may vary as much as 40 knots. By maintaining a constant thrust control position and a level flight attitude on the attitude indicator, airspeed will remain relatively constant even when erroneous readings are presented by the airspeed indicator.

**8-84. Flight in Thunderstorms.** Flight in or in close proximity to thunderstorms is to be avoided because of the accompanying severe turbulence and restricted visibility. If a thunderstorm is inadvertently encountered during flight, the procedures for flight in turbulent air are to be followed and the flight path altered to leave the area. Should a thunderstorm be encountered during a night flight, the cockpit dome light should be turned on with white light selected to minimize the blinding effect of lightning. Refer to chapter 5 for limitations.

#### 8-85. ICE AND RAIN.

**8-86. Ice.** The helicopter is equipped with pitot tube, AFCS yaw port heating, and windshield anti-icing systems to enable safe flight in light icing conditions. Operation of these systems is described in Chapter 2. Additional information and specific procedures are also included in this section under Cold Weather Operations. The greatest damage caused by ice accumulation is lowered rotor blade efficiency resulting in decreased range and endurance.

If icing is encountered during IMC flight, consideration must be given to reduced range and endurance due to increased fuel consumption. Refer to chapter 5 for limitations.

**8-87. Exterior Inspection.** Refer to paragraph 8-15.

**8-88. Taxiing.** Taxi at slow speeds to ensure positive braking action during turns. The forward tilt of the rotors will cause the helicopter to continue moving forward if icy conditions prevent braking.

**8-89. Before Takeoff.** When the takeoff is to be accomplished into possible icing conditions, the following are to be accomplished as part of the Before Takeoff Check.

ANTI-ICE switches – ON. Refer to chapter 5 for limitations.

**8-90. During Flight.** Since all of the systems on this helicopter are of the anti-icing rather than the de-icing type, always start systems at least 5 minutes before entering a suspect or forecast icing area. In addition,

engine icing can occur at temperatures above freezing.

a. Extended flight in light icing conditions may result in lateral and vertical vibrations caused by asymmetric self-shedding of ice. Minor rotor blade damage may occur from ice shedding at 10°C and below. One-per-rev lateral vibrations from asymmetric shedding at any temperature may occur. If vibrations are encountered, airspeed should be reduced and the aircraft should be flown out of the icing area.

b. Extended flight in icing conditions can result in ice accumulating on the helicopter heater fuel drain. If the heater shuts down during icing, do not attempt restart until ice is removed from the heater intake, exhaust, and heater fuel drain.

**8-91. Approach and Landing.** Accomplish a normal approach and landing; but if icing is present, increased power will be required. The forward and aft wheels accumulate ice, which can result in the brakes freezing. If icing conditions have been encountered, a zero forward ground speed landing should be accomplished.

**8-92. Rain.** It is considered that rain will have no detrimental effect on the flight characteristics or performance of the helicopter. The windshield wipers should be adjusted to FAST during an instrument approach in rain, as rain may present a restriction to visibility. Pitot heat should be used for flights in rain to prevent moisture from accumulating in the pitot tube and AFCS yaw ports and tubing.

### 8-93. SALT WATER OPERATION.

**8-94. Power Deterioration.** Salt spray ingestion in turbine engines may result in a loss in performance as well as a loss in compressor stall margin. This reduction in stall margin makes the engine susceptible to stalls during acceleration, and, more particularly, under deceleration conditions. As spray is ingested and strikes the compressor blades and stator vanes, salt is deposited. The resulting buildup gradually changes the airfoil sections, which in turn affects performance. This deterioration will be noticed as a decrease in torque and an increase in PTIT for a given N1. Should the deterioration reach the point where the compressor actually stalls, PTIT will increase, while N1 and torque will decrease. The circumstances under which power deterioration may occur during salt water operation vary

with a number of factors. The flight regime, gross weight, wind direction and velocity, pilot technique, duration of maneuver, salinity of the water, and the relative density of the salt spray, all have a bearing on performance deterioration. Intermittent operation in moderate salt spray conditions could expose the engines to enough salt spray to cause noticeable performance deterioration. During prolonged operations (such as low hovering) in heavier spray conditions, power deterioration will be apparent and is more critical. Maneuvers such as hovering close to the water in light winds, or low flights at low speeds will generate maximum rotor downwash spray conditions. Careful operation, following the procedures and limitations contained herein, in strict adherence to the prescribed maintenance procedures when operating in these conditions, should result in the preservation of rated engine power.

**8-95. Hovering.** Hovering over salt water at altitudes that cause concentrated spray into the engine inlets results in gradual power deterioration and eventual reduction of compressor stall margin. Operation in these conditions should be avoided or minimized. The following procedures are grouped according to wind conditions. Maximum hovering altitude, consistent with safety and mission accomplishment, is recommended to reduce possibility of salt spray ingestion. Prolonged hovering over salt water which results in spray ingestion, indicated by spray on the windshield, must be avoided. The amount of spray observed on the windshield is usually the best indication of spray ingestion into the engine inlets.

a. *No wind.* Hovering in a no-wind condition normally results in a relatively low spray concentration at all hovering altitudes.

b. *Light winds (approximately 5 to 16 knots).* Hovering in these conditions results in the heaviest or most critical spray concentrations. Spray can be minimized by heading changes with reference to wind direction and ascertaining minimum spray concentration on windshield.

c. *Moderate to heavy winds (15 knots and above).* Higher winds normally result in the lowest of spray concentration at all hovering altitudes. In these conditions, hovering can be accomplished into the wind.

**8-96. After Flight. Refer to Appendix C.**

## CHAPTER 9 EMERGENCY PROCEDURES

### SECTION I HELICOPTER SYSTEMS

#### 9-1. Helicopter Systems.

This section describes helicopter systems emergencies which may reasonably be expected to occur and presents the procedures to be followed. Emergency operation of mission equipment is contained in this chapter, insofar as its use affect safety of flight. Emergency procedures are given in checklist form when applicable. A condensed version of these procedures is included in TM 55-1520-240-CL. Refer to figure 9-1 and 9-2 for emergency equipment, exits, and entrance.

#### 9-2. Immediate Action Emergency Checks.

##### NOTE

The urgency of certain emergencies requires immediate and instinctive action by the pilot. The most important single consideration is helicopter control. All other procedures are subordinate to this requirement. The MASTER CAUTION should be reset after each malfunction to allow systems to respond to subsequent malfunctions. When appropriate, a check of the affected PDP for open circuit breakers should be accomplished, in some cases this may minimize or eliminate the emergency. An example of this would be an apparent failure of an instrument, whereas resetting the circuit breaker restores operation. If time permits during a critical emergency, jettison external loads, and lock shoulder harnesses.

Those steps that must be performed **immediately** in an emergency procedure **are underlined**. These steps must be performed without reference to the checklist (CL). When the situation permits, non-underlined steps will be accomplished with the use of the CL.

#### 9-3. Definition of Emergency Terms.

For the purpose of standardization, the following definitions shall apply:

a. The term **LAND AS SOON AS POSSIBLE** is defined as executing a landing to the nearest suitable landing area (e.g., open field) **without delay**. (The primary consideration is to assure the survival of occupants.)

b. The term **LAND AS SOON AS PRACTICABLE** is defined as executing a landing at the nearest suitable airfield/heliport.

c. The term **AUTOROTATE** is defined as adjusting the flight controls as necessary to establish an autorotational descent and landing.

1. **Thrust control — Adjust** as required to maintain RRPM.
2. **Pedals — Adjust** as required.
3. **Cyclic — Adjust** as required.

d. The term **EMER ENG SHUTDOWN** is defined as engine shutdown **without delay**. Engine shutdown in flight is usually not an immediate-action item unless a fire exists. Before executing an engine shutdown, identify the affected engine by checking indications of torque, RRPM, N1, PTIT, engine oil pressure and **714A** ENG FAIL Caution.

##### CAUTION

**When in-flight shutdown of a malfunctioning engine is anticipated, positive identification of the malfunctioning engine must be accomplished to avoid shutting down the wrong engine.**

1. **ENG COND lever — STOP.**
2. **FIRE PULL handle — Pull** (engine fire only).
3. **AGENT DISCH switch — As required** (engine fire only).

e. The term **ABORT START** is defined as engine shutdown to prevent PTIT from exceeding limits or whenever abnormal operation is indicated. If high PTIT was indicated, the engine must be motored to decrease PTIT below 260°C.

1. **ENG COND lever — STOP.**
2. **ENG START switch — MTR** (if high PTIT is indicated).

##### NOTE

If a second engine start is to be attempted, wait at least 15 seconds after the N1 tachometer indicates zero before attempting start. This will allow sufficient time for fuel to drain from the combustion chamber.

#### 9-4. Emergency Warning Signals and Exits.

The helicopter is equipped with an emergency troop alarm and jump light system. The following standard signals will be used to notify occupants of an emergency situation:



1. Prepare for ditching, or crash landing — **3 short rings.**
2. Water contact — **Sustained ring.**

Emergency equipment, exits, and entrance routes are shown in figures 9-1 and 9-2. Emergency exit door handles are yellow and black striped. Emergency equipment consists of seven first aid kits, three hand fire extinguishers, one emergency escape axe, and three emergency exit lights.

**9-5. After-Emergency Action.**

After a malfunction of equipment has occurred, appropriate emergency actions have been taken, and the helicopter is on the ground, an entry must be made in the Remarks Section of DA Form 2408-13, describing the malfunction.

**9-6. ENGINE.**

**9-7. Flight Characteristics.**

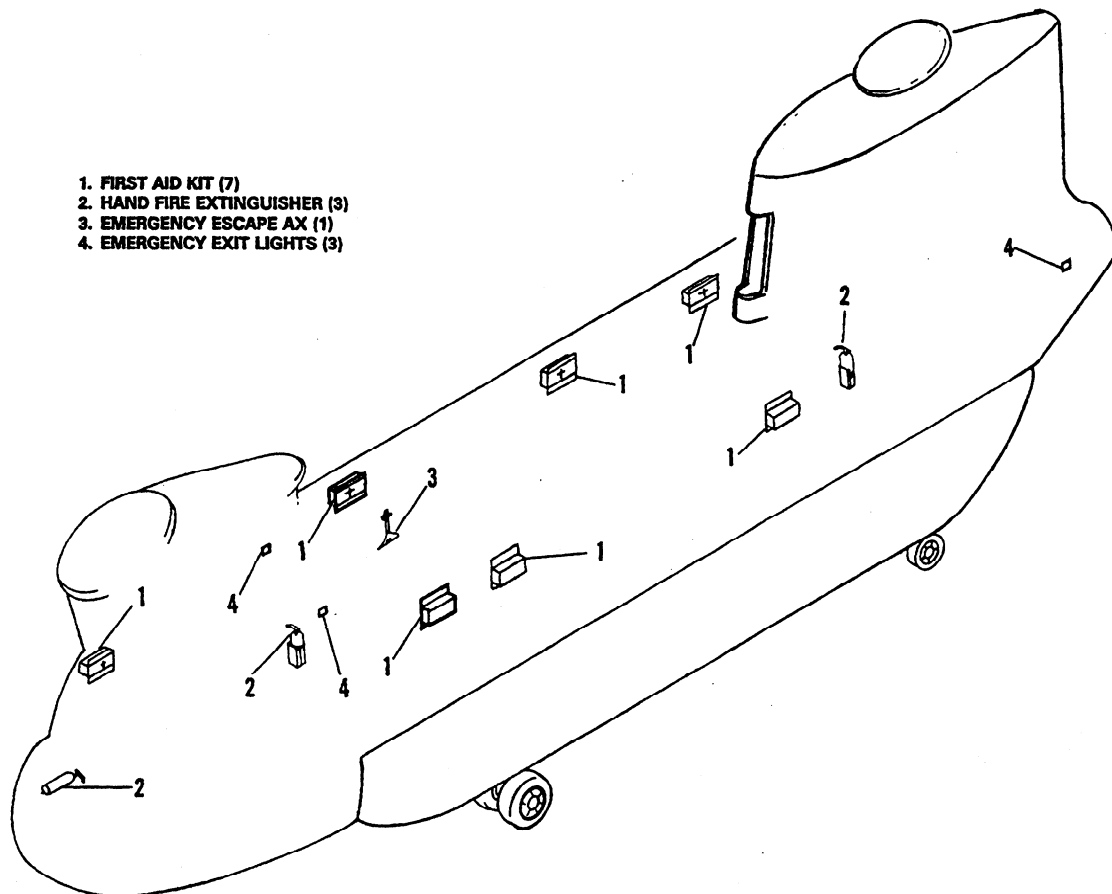
a. If an engine failure occurs, no control problems exist unless power from the remaining engine is not sufficient to maintain the selected RRPM. If sufficient power is not available to maintain altitude, descend to an altitude where single-engine (S/E) flight can be accomplished (fig. 9-3 and 9-4.1 for S/E performance data). The best indications of engine failure are decreased torque on the failed engine and a compensating increase in torque on the remaining engine, accompanied by a droop in RRPM, and a continuing decrease in N1 speed below 60 percent. An engine failure

will have no effect on any of the helicopter systems as long as the RRPM is maintained above the minimum speed. On the **714A** a 1% to 3% NR momentary transient can be anticipated. Then NR will automatically recover to the selected NR.

b. **712** When one engine fails, rotor speed can be expected to drop to as low as 93 percent. Safe RRPM can usually be regained by using engine beep trim and power available of the operating engine.

c. If sufficient power is not available, normal RRPM is regained by lowering the thrust control. Procedures to be followed after engine failure will be governed by the altitude and airspeed available for helicopter control and for maintaining sufficient RRPM for continued flight and landing. The height-velocity diagram (fig. 9-4 and 9-4.2) presents the airspeeds and wheel heights from which a safe landing can be made at various GW and temperatures following a S/E failure.

d. Decrease in thrust after engine failure will vary with altitude and airspeed at the time of occurrence. For example, thrust must not be decreased when an engine (or engines) fail at a hover in-ground-effect (HIGE); whereas, during cruise flight conditions, altitude and airspeed are sufficient for a significant reduction in thrust, thereby allowing rotor speed to be maintained in the safe operating range. Following an engine failure, cyclic control is adjusted as necessary to



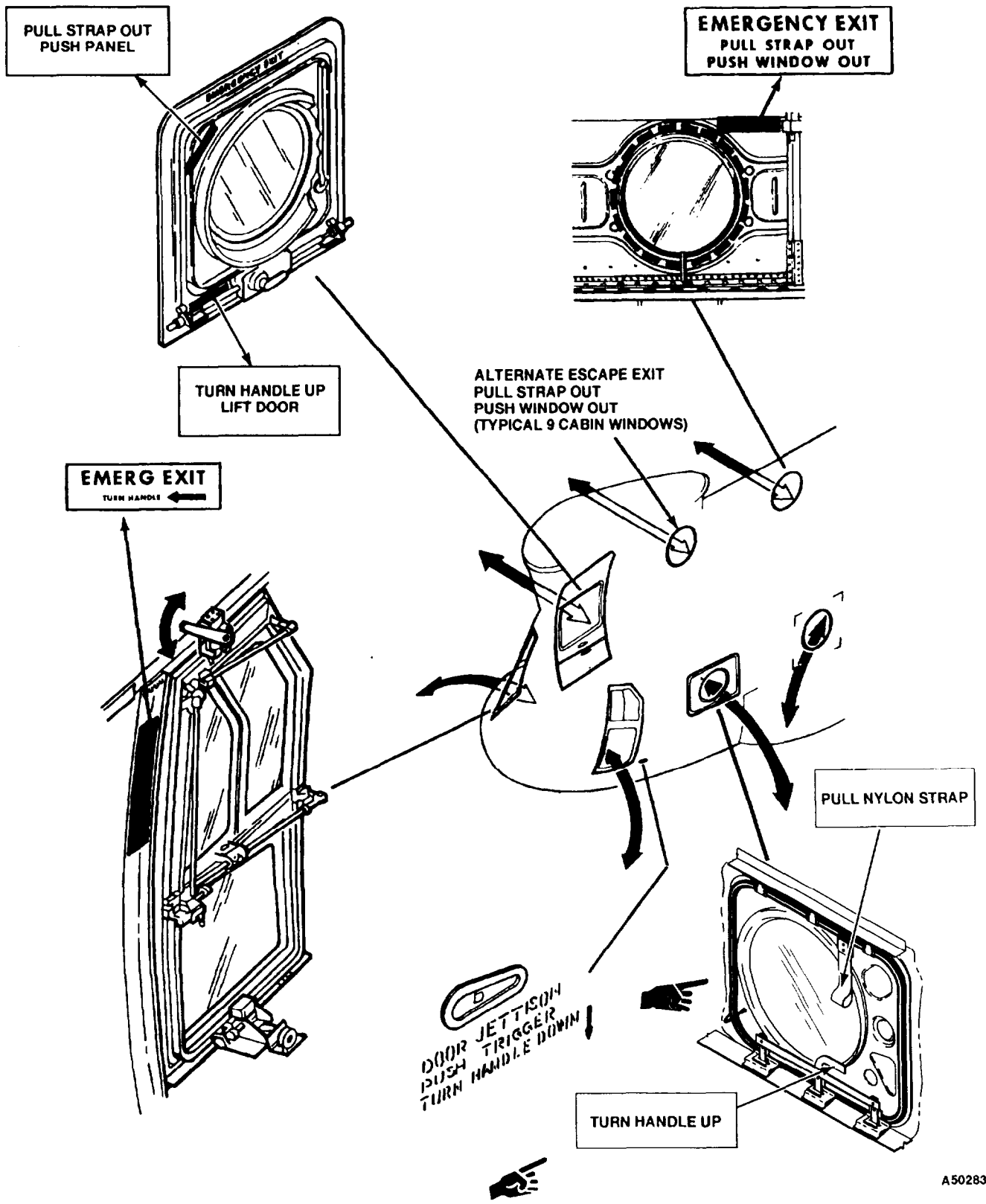
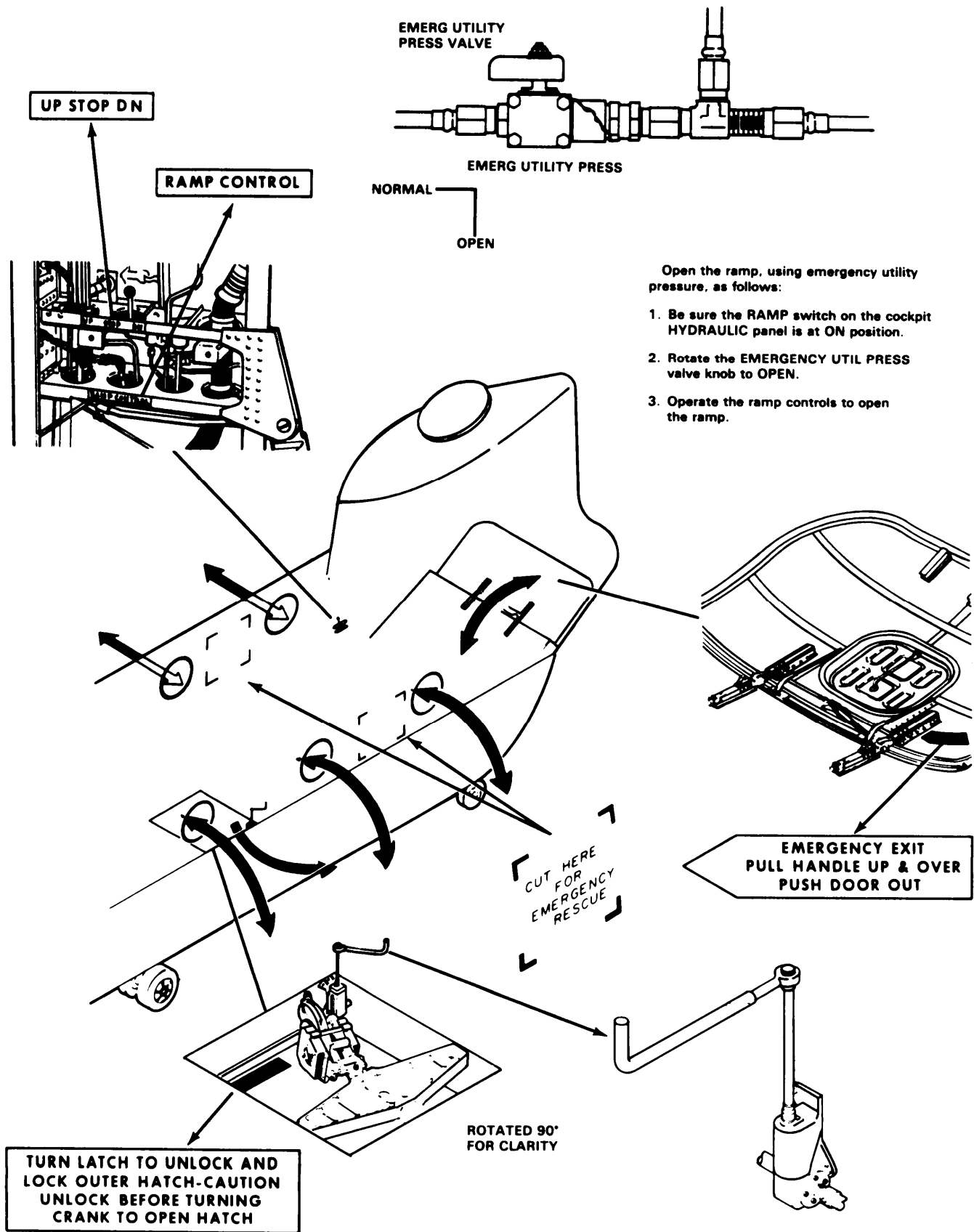


Figure 9-2. Emergency Entrance and Escape Routes (Sheet 1 of 2)



Open the ramp, using emergency utility pressure, as follows:

1. Be sure the RAMP switch on the cockpit HYDRAULIC panel is at ON position.
2. Rotate the EMERGENCY UTIL PRESS valve knob to OPEN.
3. Operate the ramp controls to open the ramp.

Figure 9-2. Emergency Entrance and Escape Routes (Sheet 2 of 2)

remain in hover over the desired point or to control airspeed and flight path in forward flight. Pedal pressure is applied as necessary to control aircraft heading.

e. Airspeed should be maintained at the optimum for existing conditions for continued flight (S/E failure) or for autorotational descent (dual-engine failure). As airspeed increases above 70 KIAS in autorotation, there is a corresponding increase in rate of descent (R/D). Airspeed up to 100 KIAS or  $V_{ne}$ , whichever is slower, will increase glide distance but should be avoided at low altitude because the time available to decelerate is critical. At airspeeds below 70 KIAS, R/D in autorotation increases and glide distance decreases. Gliding the helicopter in autorotation out-of-trim will also increase R/D and decrease glide distance

#### 9-8. Minimum Rate of Descent — Power Off.

The power off minimum R/D is attained at an indicated airspeed of approximately 70 knots and 100% RRPM (fig. 9-5).

#### 9-9. Maximum Glide Distance — Power Off.

The maximum glide distance is attained at an indicated airspeed of 100 knots or  $V_{ne}$ , whichever is slower, and 100% RRPM (fig. 9-5).

#### 9-10. Dual Engine Failure.

##### CAUTION

**Jettison external cargo as soon as possible after engine failure. This will help to prevent damage to the helicopter during touchdown and will reduce weight and drag, thereby improving autorotational performance.**

a. *Low Altitude/ Low Airspeed.* When both engines fail at low altitude and low airspeed, sufficient altitude is not available to increase RRPM. Establish the best autorotational airspeed, jettison external cargo (if applicable), and decelerate effectively prior to touchdown. Initial thrust reduction will vary from no reduction at zero airspeed below 20 feet to full reduction at higher airspeeds and altitudes. Attempt to maintain at least 96 percent.

##### CAUTION

**The helicopter must be maneuvered into the autorotation approach corridor prior to landing to assure a safe outcome of the maneuver.**

b. *Cruise.* In cruise flights up to  $V_{ne}$ , reduce thrust immediately to full down position to regain RRPM. Adjust cyclic pressure as necessary to attain and maintain the

required airspeed. The Autorotation Approach Corridor, figure 9-6 and figure 9-4.1, presents those combinations of airspeeds and wheel heights from which a safe autorotative landing may be made following a second engine failure. Autorotative approaches are recommended in the caution area. At high gross weights, the rotor may tend to overspeed and may require thrust application to maintain RPM below the upper limit. Thrust should never be applied to reduce RPM for extending glide distance because this reduces RPM available for use during touchdown. When both engines fail at cruise, proceed as follows:

1. AUTOROTATE.
2. External cargo — Jettison.
3. ALT switch — Disengage.

#### 9-11. Single Engine Failure.

The action taken after one engine fails will depend on altitude, airspeed, phase of flight, areas available for landing, and S/E capability of the helicopter. Immediately after any engine malfunction, the flight engineer should check the engine for the possibility of fire. If required, external cargo should be jettisoned as soon as possible after engine failure. This will help to prevent damage to the helicopter during touchdown and will reduce weight and drag, thereby improving S/E performance.

Thrust control adjustments will depend on altitude at the time of the engine failure. For example, at (HIGE) below 20 feet, maintain thrust control position as the operative engine beep trim is increased. At a hover above 20 feet, thrust should be lowered slightly to maintain at least 96 percent RRPM. If altitude permits, thrust may be lowered sufficiently to maintain normal RRPM.

Cyclic inputs will depend on altitude and airspeed. At a (HIGE), the helicopter should be maintained in a hovering attitude. In forward flight, at low altitude (below 50 feet), when S/E flight is not possible a decelerating attitude should be assumed to dissipate airspeed and aid in cushioning the helicopter. If airspeed is slow and altitude permits, the helicopter should be placed in an accelerating attitude of up to 30° nose-low to gain airspeed as the operative engine beep trim is increased. This nose-low attitude should not be used at an extremely low altitude because of reduced reaction time, R/D, and the response of the helicopter. Any time the helicopter assumes a decelerating attitude in close proximity to the ground, avoid rotating the aft gear into the ground at touchdown.

**SINGLE ENGINE SERVICE CEILING  
EMERGENCY TORQUE AVAILABLE**

CLEAN CONFIGURATION

100% ROTOR RPM

JP-4 FUEL

**SINGLE ENGINE  
SERVICE CEILING  
CH-47D  
(1) T55-L-712**

**EXAMPLE**

**WANTED**

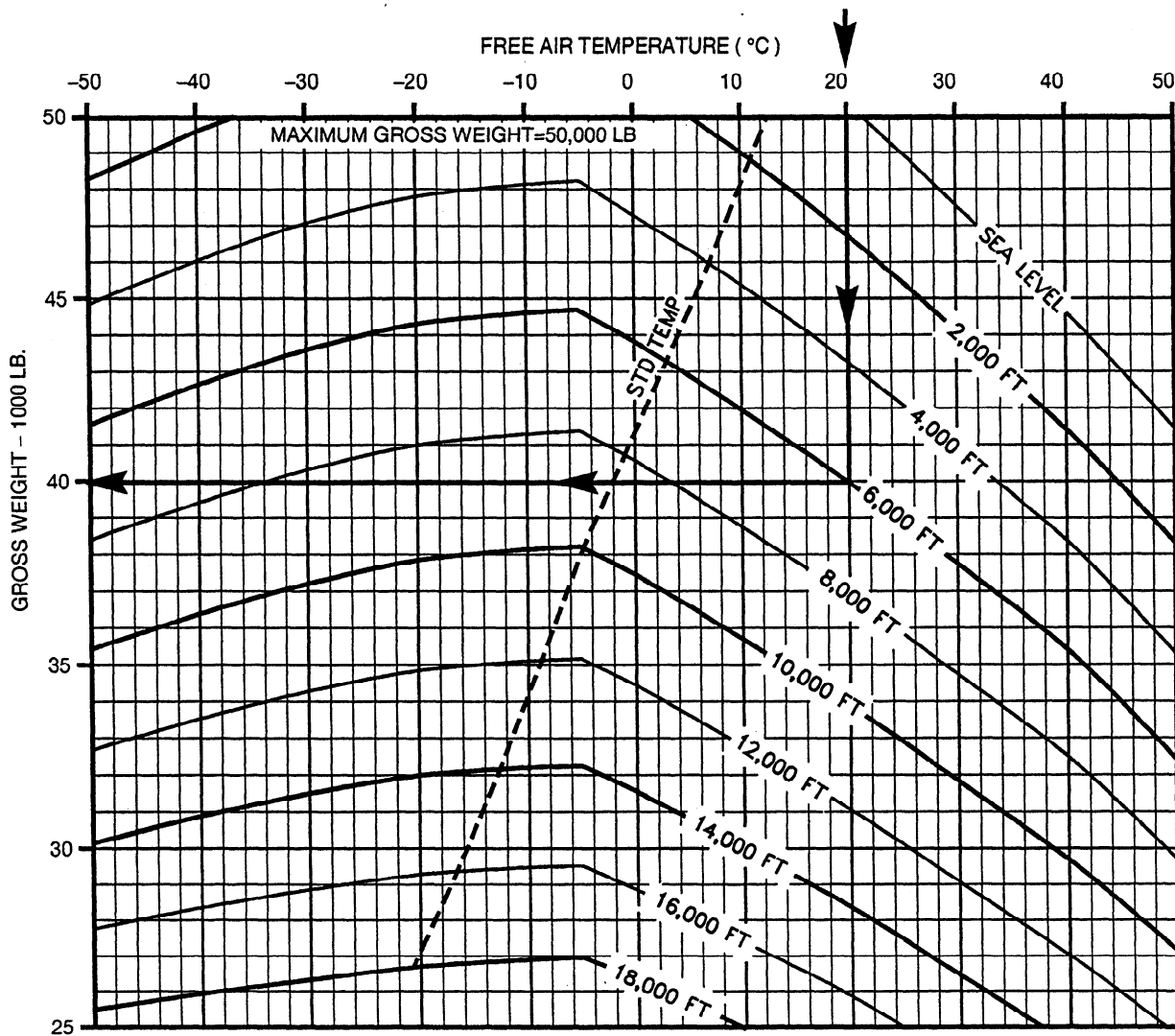
MAXIMUM SINGLE ENGINE WEIGHT  
AT DESIRED SERVICE CEILING

**KNOWN**

PRESSURE ALTITUDE = 6,000 FT/FAT = 20°C

**METHOD**

ENTER FAT HERE  
MOVE DOWN TO PRESSURE ALTITUDE  
MOVE LEFT AND READ MAXIMUM  
SINGLE ENGINE GROSS WEIGHT  
=39,990 LB



DATA BASIS: FLIGHT TEST

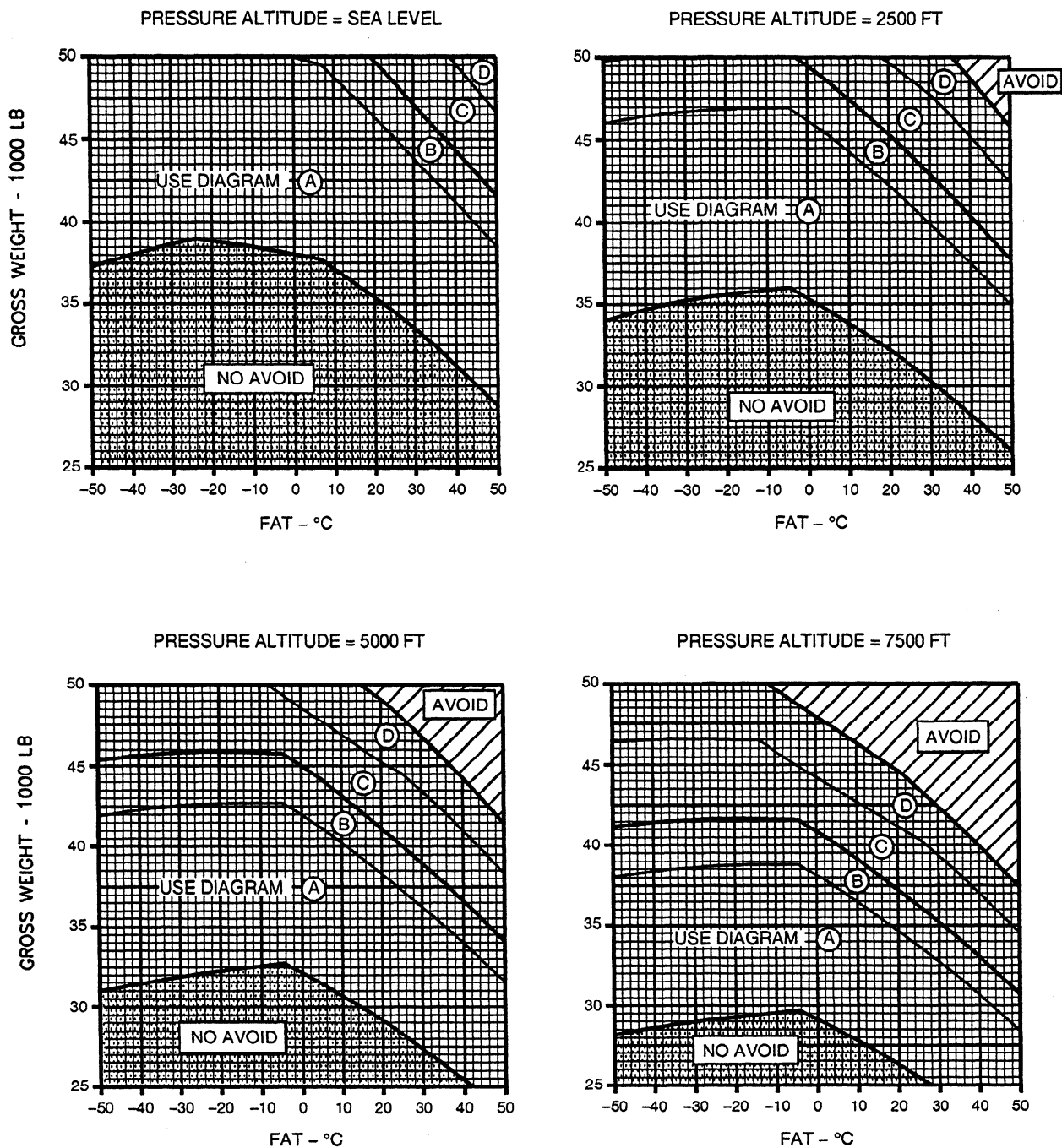
A9732

Figure 9-3. **712** Single-Engine Service Ceiling

### HEIGHT VELOCITY DIAGRAM FOR SAFE LANDING AFTER SINGLE-ENGINE FAILURE

HEIGHT VELOCITY  
CH-47D  
(2) T55-L-712

NOTE: USE THE FOLLOWING DIAGRAMS WITH THOSE SHOWN ON SHEET 3



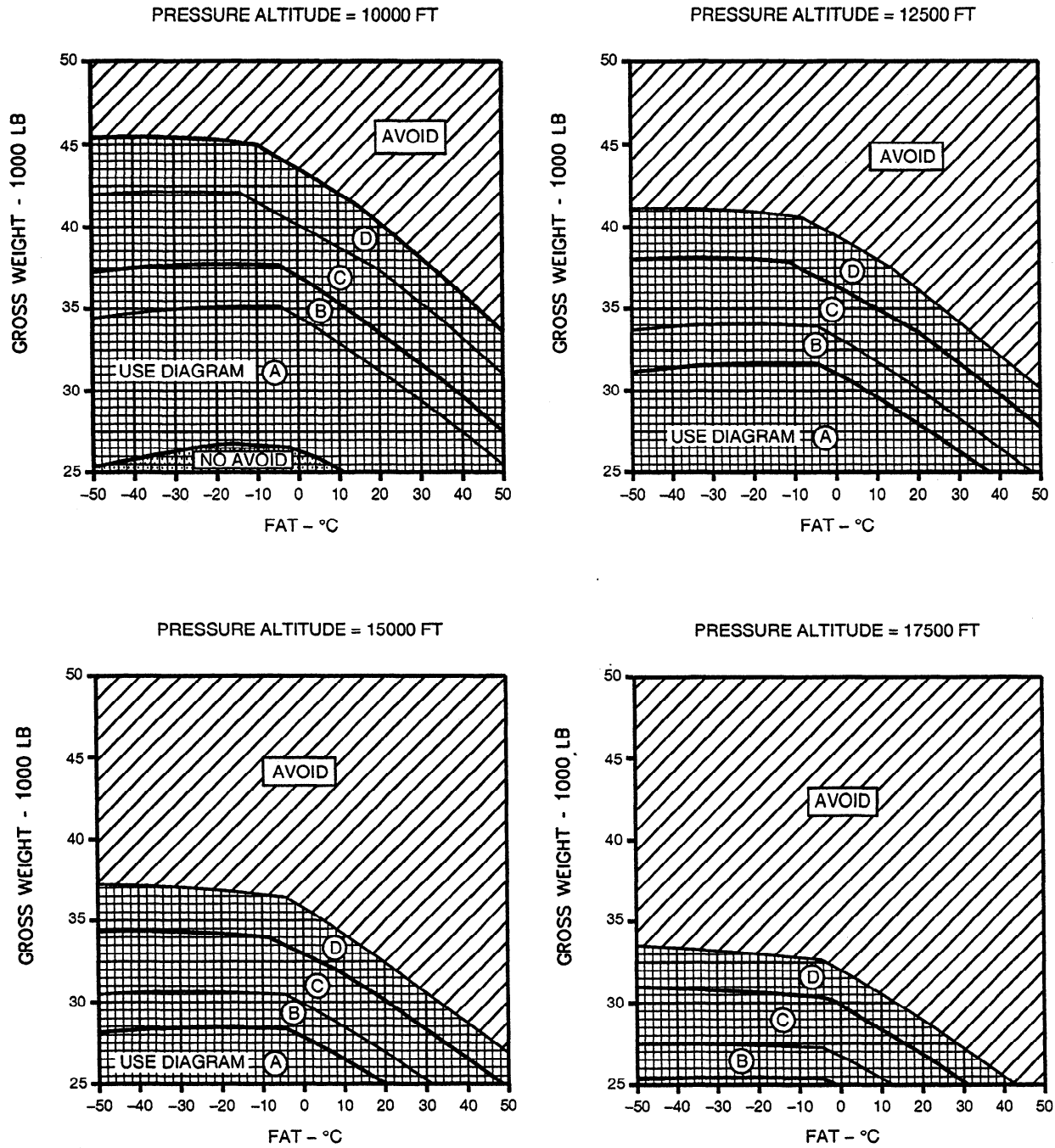
A23134

Figure 9-4. **712** Height Velocity Diagram for Safe Landing  
After Single-Engine Failure (Sheet 1 of 3)

## HEIGHT VELOCITY DIAGRAM FOR SAFE LANDING AFTER SINGLE-ENGINE FAILURE

**HEIGHT VELOCITY  
CH-47D  
(2) T55-L-712**

NOTE: USE THE FOLLOWING DIAGRAMS WITH THOSE SHOWN ON SHEET 3

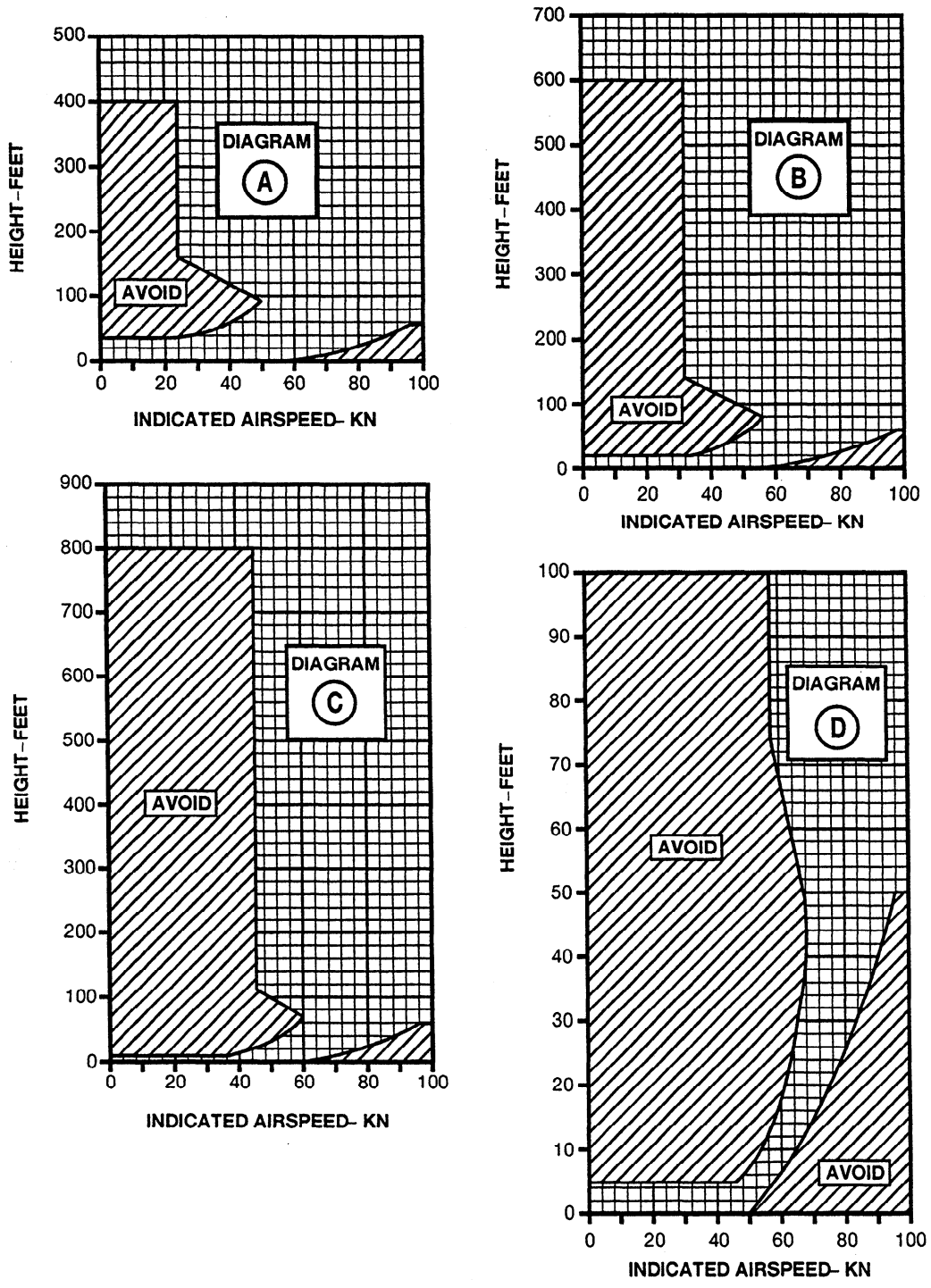


A23155

Figure 9-4. **712** Height Velocity Diagram for Safe Landing After Single-Engine Failure (Sheet 2 of 3)

**HEIGHT VELOCITY DIAGRAM FOR SAFE LANDING AFTER SINGLE ENGINE FAILURE**

**HEIGHT VELOCITY  
CH-47D  
(2) T55-L-712**



A24037

*Figure 9-4. **712** Height Velocity Diagram for Safe Landing After Single-Engine Failure (Sheet 3 of 3)*



# SINGLE ENGINE SERVICE CEILING

## EMERGENCY TORQUE AVAILABLE

CLEAN CONFIGURATION      100% ROTOR RPM

**SINGLE ENGINE SERVICE CEILING**  
**CH-47D**  
**(1) T55-GA-714A**

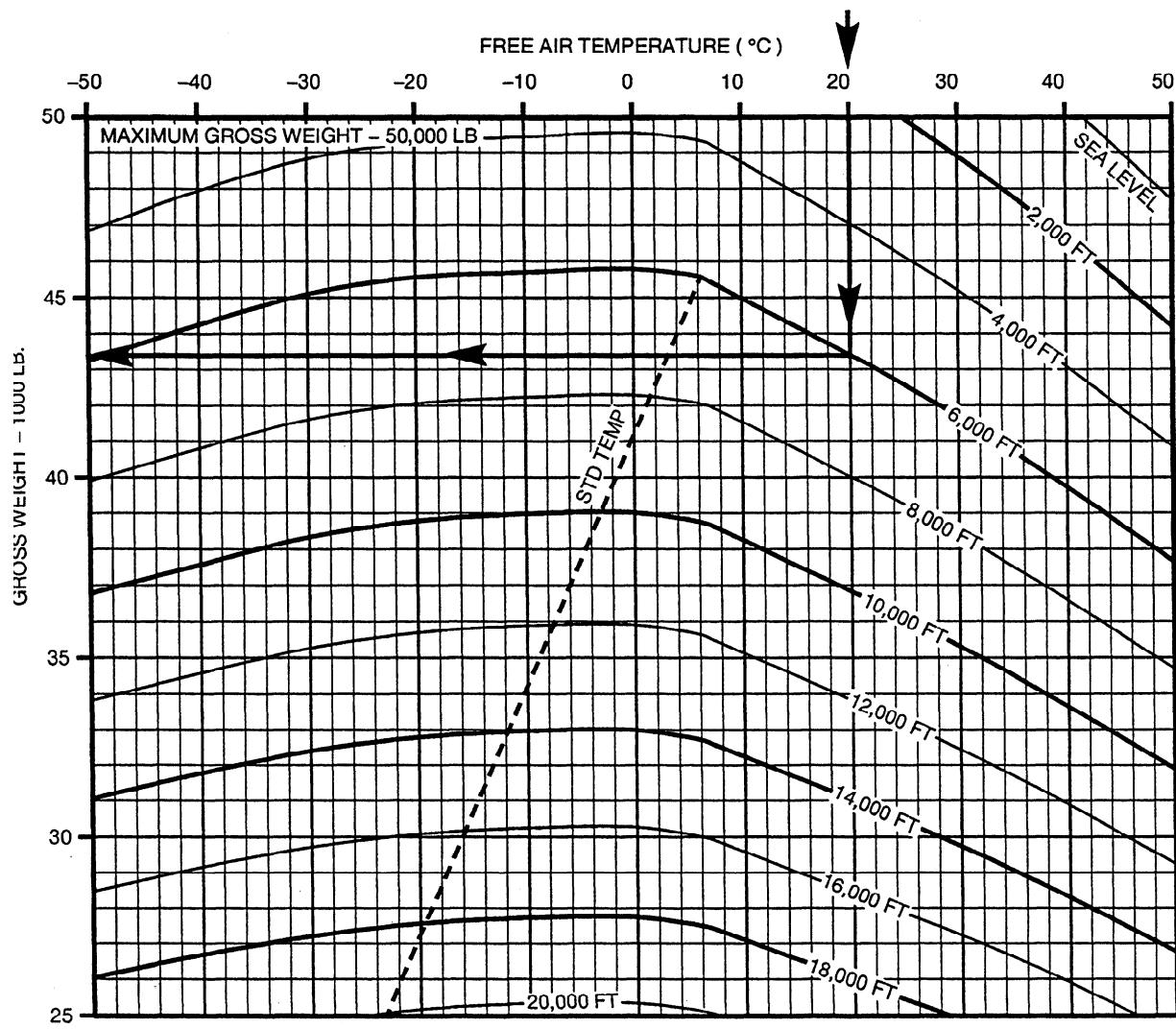
**EXAMPLE**

**WANTED**  
 MAXIMUM SINGLE ENGINE WEIGHT  
 AT DESIRED SERVICE CEILING

**KNOWN**  
 PRESSURE ALTITUDE = 6,000 FT/FAT = 20°C

**METHOD**

ENTER FAT HERE  
 MOVE DOWN TO PRESSURE ALTITUDE  
 MOVE LEFT AND READ MAXIMUM  
 SINGLE ENGINE GROSS WEIGHT  
 =43,400 LB



DATA BASIS: FLIGHT TEST

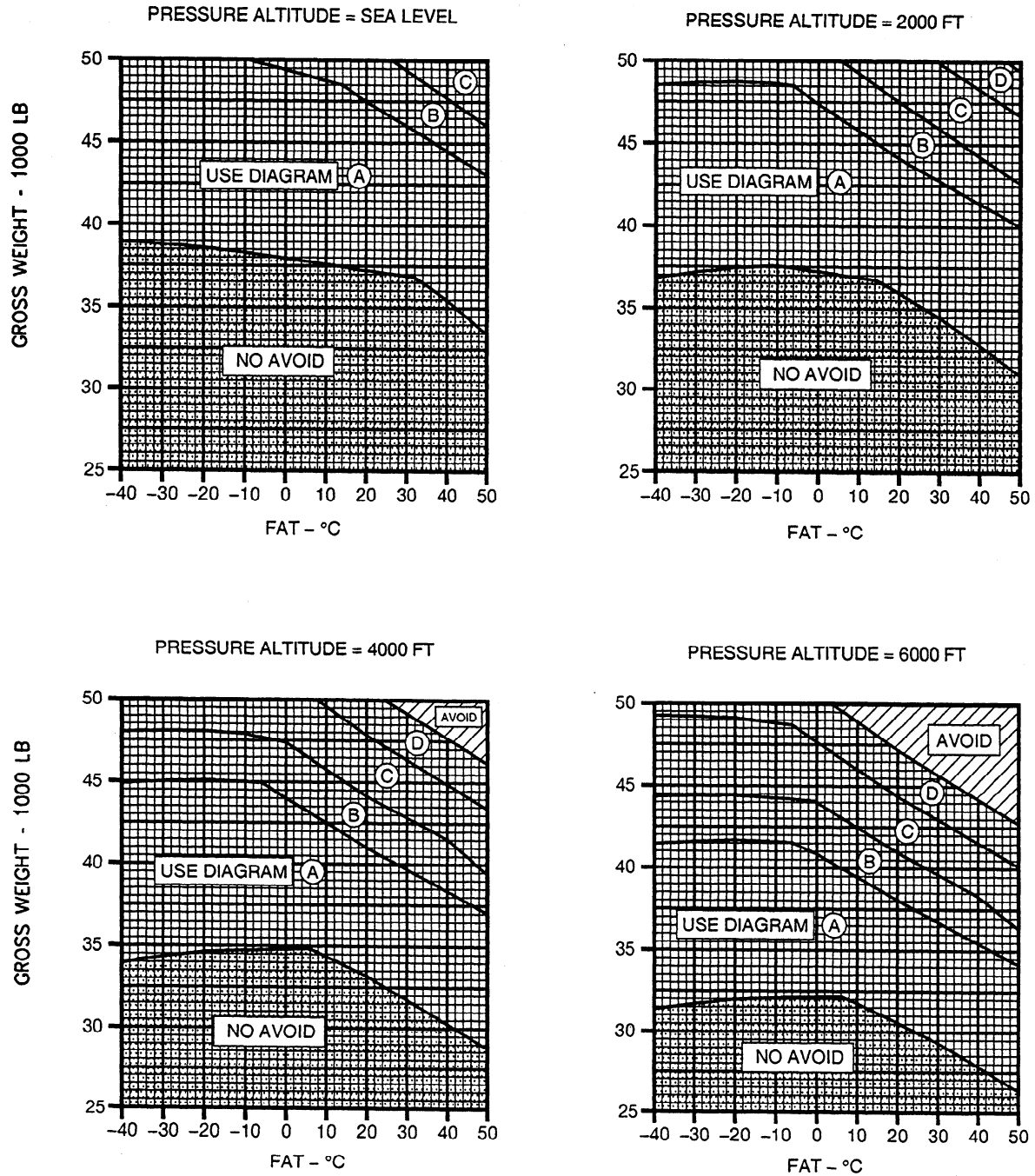
A60119

Figure 9-4.1. **714A** Single-Engine Service Ceiling

# HEIGHT VELOCITY DIAGRAM FOR SAFE LANDING AFTER SINGLE-ENGINE FAILURE

HEIGHT VELOCITY  
CH-47D  
T55-GA-714A

NOTE: USE THE FOLLOWING DIAGRAMS WITH THOSE SHOWN ON SHEET 3



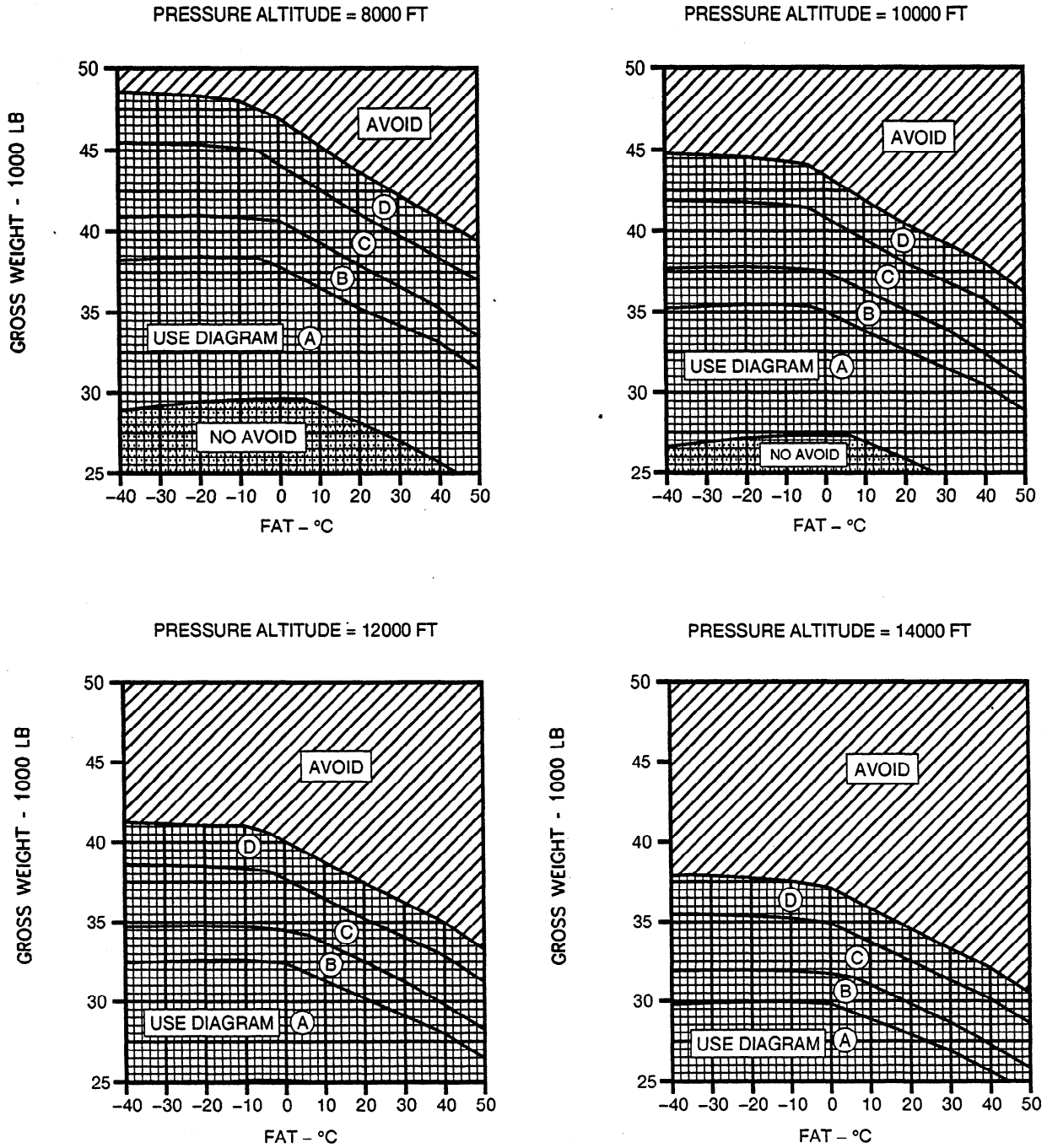
A60125

Figure 9-4.2. **714A** Height Velocity Diagram for Safe Landing After Single-Engine Failure (Sheet 1 of 3)

## HEIGHT VELOCITY DIAGRAM FOR SAFE LANDING AFTER SINGLE-ENGINE FAILURE

HEIGHT VELOCITY  
CH-47D  
T55-GA-714A

NOTE: USE THE FOLLOWING DIAGRAMS WITH THOSE SHOWN ON SHEET 3

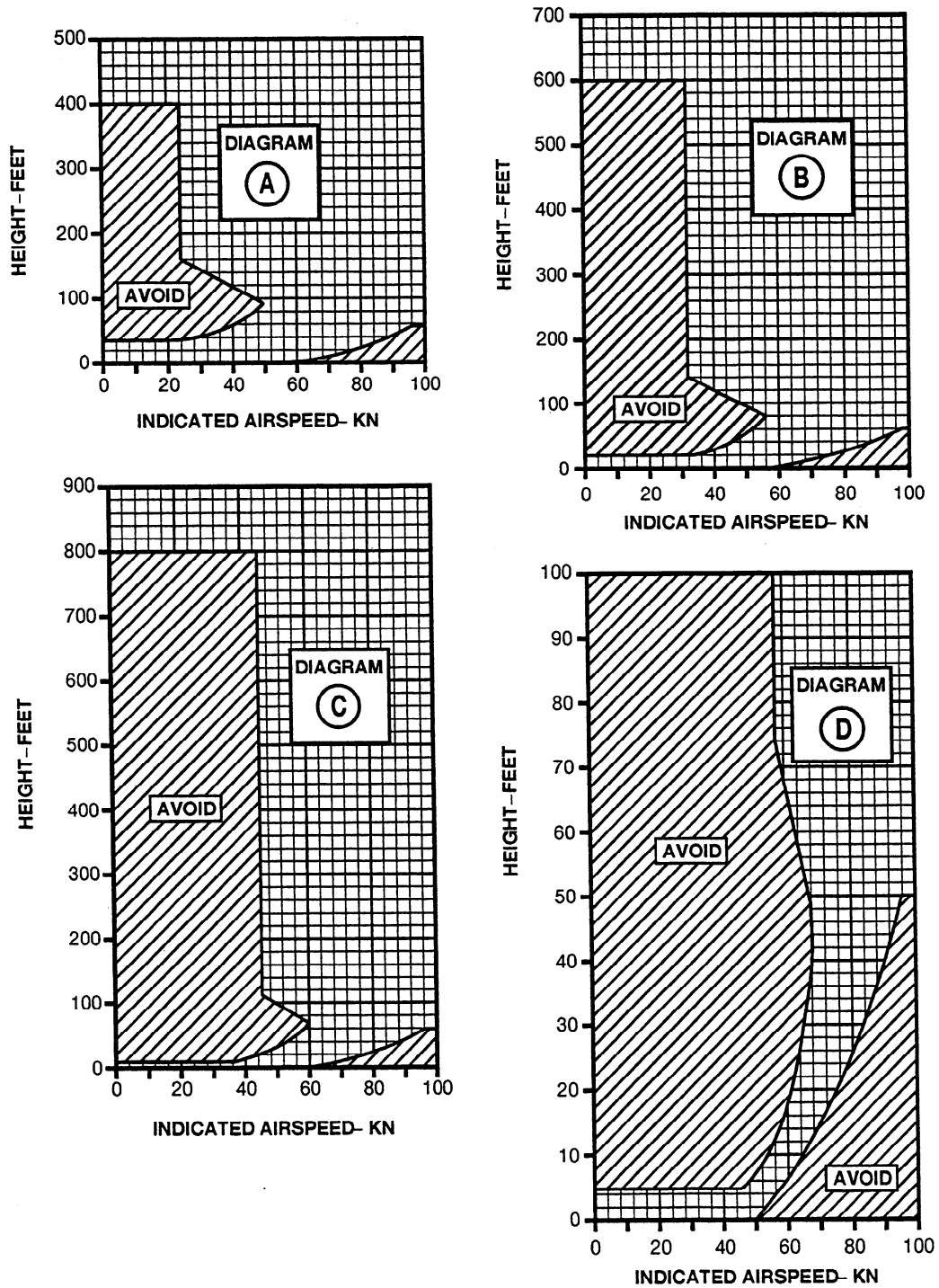


A60126

Figure 9-4.2. **714A** Height Velocity Diagram for Safe Landing After Single-Engine Failure (Sheet 2 of 3)

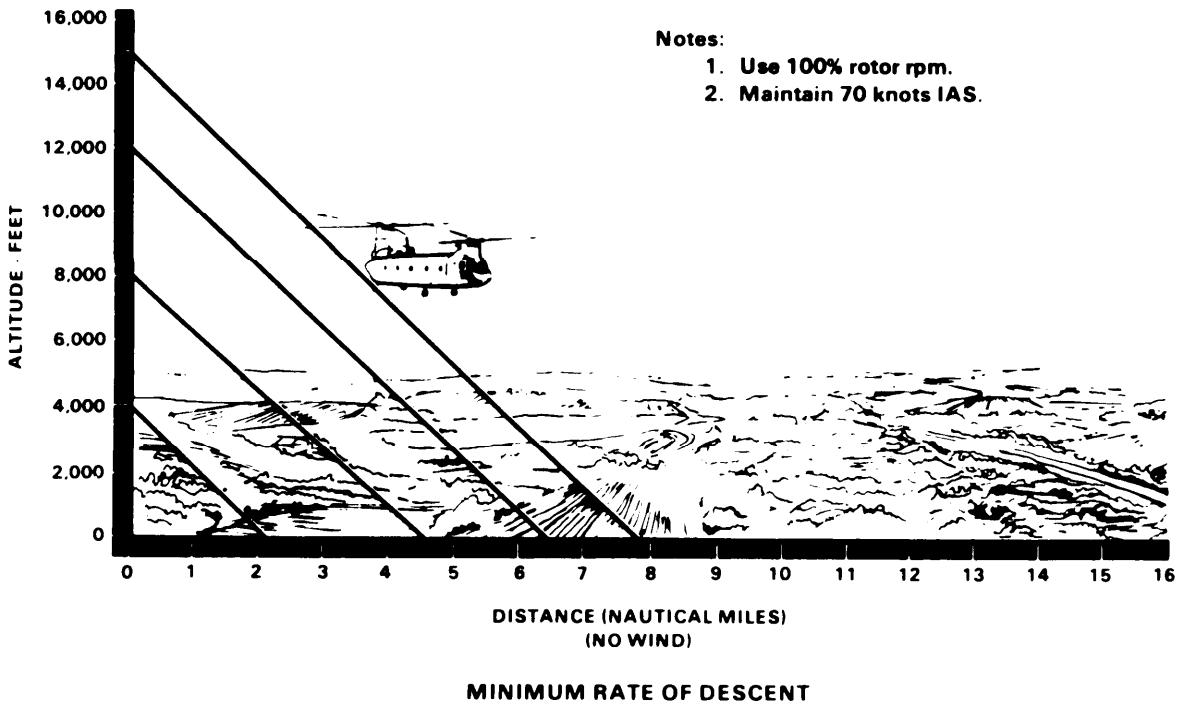
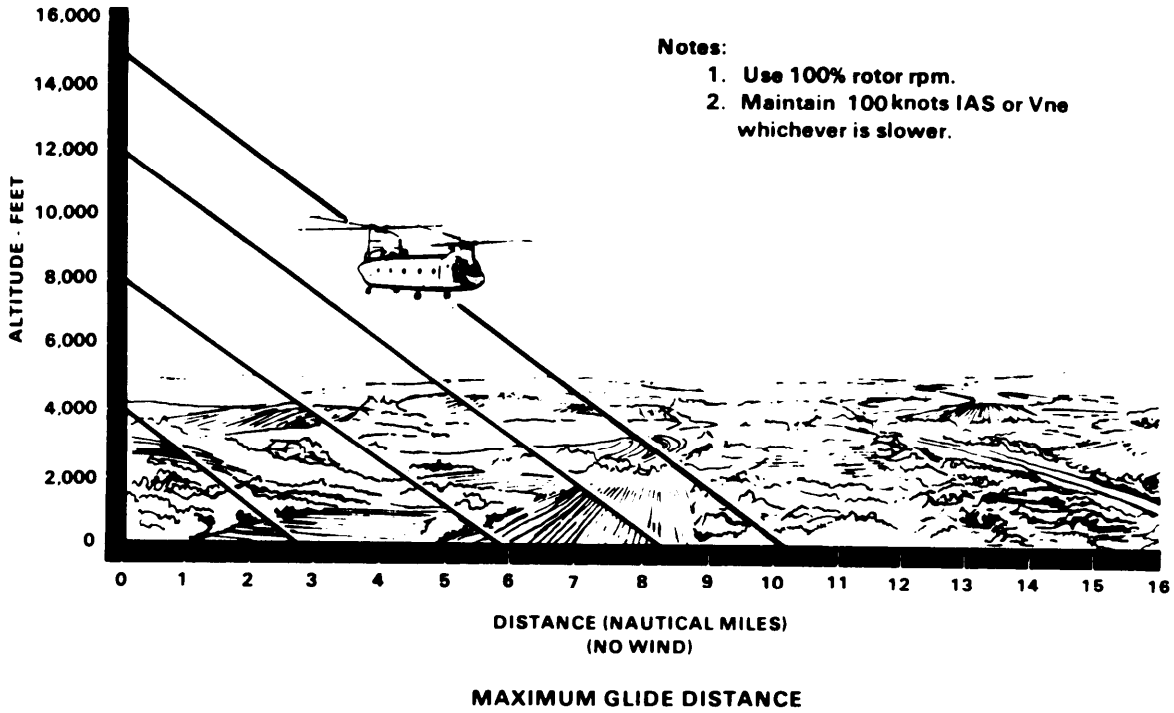
# HEIGHT VELOCITY DIAGRAM FOR SAFE LANDING AFTER SINGLE ENGINE FAILURE

HEIGHT VELOCITY  
CH-47D  
T55-GA-714A



A60127

Figure 9-4.2. **714A** Height Velocity Diagram for Safe Landing After Single-Engine Failure (Sheet 3 of 3)



DI45-72-10

Figure 9-5. Maximum Glide Distance/Minimum Rate of Descent in Autorotation

**AUTOROTATIONAL APPROACH CORRIDOR  
FOR SECOND ENGINE FAILURE FROM  
SINGLE ENGINE LEVEL FLIGHT**

**AUTOROTATIONAL  
APPROACH CORRIDOR  
AFTER SECOND ENGINE  
FAILURE  
CH-47D  
T55-L-712 AND  
T55-GA-714A**

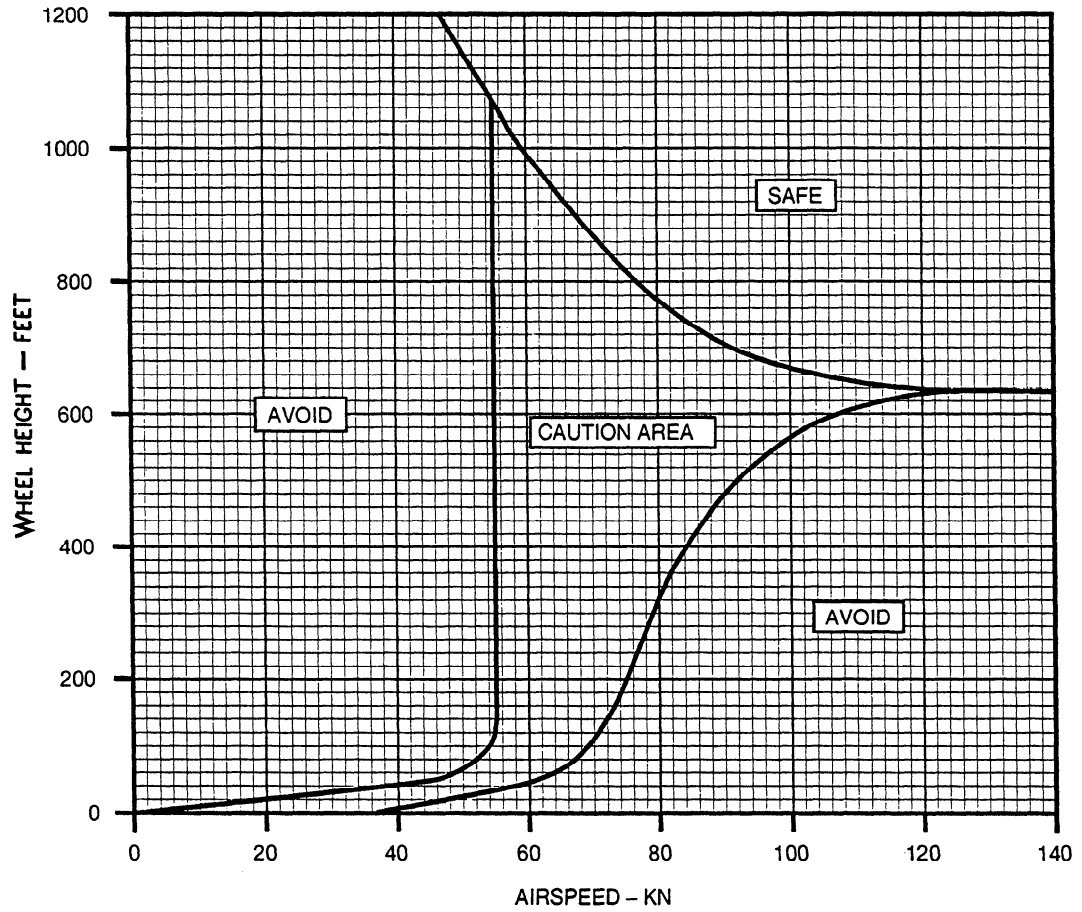


Figure 9-6. **712 714A** Autorotational/ Approach Corridor for Second Engine Failure

A75375

**9-11.1. 714A ENG 1 FAIL or ENG 2 FAIL.**

The ENG 1 FAIL or ENG 2 FAIL caution is illuminated whenever the engine failure logic within the DECU recognizes any one of the following:

1. Power turbine shaft failure. N2 is greater than RRPM by more than 3%.
2. N1 underspeed. N1 speed is below 48%.
3. Engine flameout.
4. Over temperature start abort (Primary mode only).
5. Primary system fail freeze (Primary and Reversionary mode hard faults, FADEC caution is illuminated).
6. During normal shutdown as the N1 rpm goes below 48% the ENG 1 FAIL or ENG 2 FAIL caution is illuminated and then is turned off 12 seconds after the N1 rpm drops below 40%.

**9-12. Single Engine Failure — Low Altitude/Low Airspeed and Cruise.**

If an engine fails under conditions that will permit S/E flight, thrust 712 engine beep trim must be adjusted as required to maintain safe RRPM. Initial thrust reduction will vary from no reduction at zero airspeed below 20 feet to a significant reduction at higher altitudes and airspeeds. Attempt to maintain at least 96 percent RRPM. If the helicopter is below the best S/E climb airspeed, forward cyclic must be applied to attain that speed. When (HOGE), forward cyclic pressure must be applied to attain a nose-low attitude of up to 30° in order to gain airspeed. As airspeed increases to 30 knots, adjust the pitch attitude of the aircraft to accelerate to the best S/E climb speed.

If an engine fails under conditions that **will not** permit S/E flight, the procedures will be essentially the same as for continued flight, except that cyclic pressures are applied to decelerate the helicopter for touchdown, rather than continued acceleration. During deceleration, just prior to touchdown, avoid rotating the aft landing gear into the ground.

*Continued flight is possible:*

1. **Thrust control — Adjust** as necessary to maintain RRPM.
2. **712 ENGINE BEEP TRIM switch — RPM INCREASE** as required.
3. **External cargo — Jettison** (if required).
4. **ALT switch — Disengage.**
5. Land as soon as practicable.
6. **EMER ENG SHUTDOWN (when conditions permit).**

**NOTE**

If S/E flight can be maintained, an attempt to restart the inoperative engine may be made if there is no evidence of fire or obvious mechanical damage.

*Continued flight is not possible:*

**Land as soon as possible.**

**9-13. Engine Restart During Flight.****WARNING**

**Fire detector and extinguishing systems are not provided for the APU. Crewman must monitor APU area for fire.**

**CAUTION**

**If abnormal indications are present during the restart, shut down the engine immediately.**

1. APU — Start.
2. 712 ENG COND lever (inoperative engine) — STOP
- 2.1 714A ENG COND lever (inoperative engine) — STOP, then GND.
3. FIRE PULL handle — In.
4. All FUEL PUMP switches — ON.
5. XFEED switch — As required.
6. Starting engine — Perform.
7. APU — OFF.

**9-14. 712 Normal Engine Beep Trim System Failure (High Side) or N2 Governor Failure.**

Failure of the normal engine beep trim system to the high side may be recognized by increasing torque on the affected engine, decreasing torque on the unaffected engine, an increase in RRPM, and a lack of response of normal engine beep trim. These indications should be confirmed by observing all the engine instruments.

Controlling RRPM with the ECL must be done smoothly and with care. Engine response is much faster and it is possible to cause the RRPM to exceed limitations or decrease to the point that the generators will be disconnected from the buses. If the thrust control is moved, it is necessary to control RRPM with the engine condition lever and the No.1 & 2 ENGINE BEEP TRIM switch. If a malfunction to the high side occurs, perform the following:

1. **Thrust control — Adjust** as required to maintain RRPM within limits.
2. **ENG COND lever (affected engine) — Adjust** to a position between FLT and GND that will control RRPM.
3. **ENGINE BEEP TRIM switch NO. 1 & 2 — Adjust** as required.
4. Land as soon as practicable

**9-15. 712 Normal Engine Beep Trim System Failure (Low Side or Static).**

Failure of the normal engine beep trim system to the low side can be recognized by decreasing torque on the affected

engine, increasing torque on the unaffected engine, a loss of RRPM, a lack of response to ENGINE BEEP TRIM and N1 stabilized at or above ground idle (60 to 63% N1). These indications also accompany an engine failure; therefore, engine instruments must be monitored to determine which event has occurred. A static failure may be recognized by failure of one or both engines to respond to beep commands or may resemble a high or low side failure when the thrust control is lowered or raised

If the thrust control is moved with either EMERG ENG TRIM AUTO/MANUAL switch in MANUAL, it is necessary to control RRPM and torque by use of the appropriate EMERG ENG TRIM INC or DECR switch. Perform the following:

1. **EMERG ENG TRIM** switch (affected engine) — Adjust as required.
2. **EMERG ENG TRIM AUTO/MANUAL** switch (affected engine) — MANUAL.
3. **EMERG ENG TRIM** switch (affected engine) — Adjust in coordination with the **ENGINE BEEP TRIM NO. 1 & 2** switch to normal operating RRPM and match torque.

#### 9-15.1. **714A** FADEC FAILURES.

#### 9-15.2. **714A** FADEC 1 or FADEC 2 Caution.

1. **FADEC INC-DEC** beep switch (affected engine) — Match TQs.
2. Reduce rate of THRUST CONT lever change.
3. Land as soon as practicable.

#### 9-15.3. **714A** FADEC 1 and FADEC 2 Cautions.

1. **FADEC ENG 1 and ENG 2 INC-DEC** beep switches — Beep to 100 percent, match TQs.
2. Reduce rate of THRUST CONT lever changes.
3. Land as soon as practicable.

#### 9-15.4. **714A** Reversionary System Failures.

##### NOTE

The aircrew should be alert to the possibility of abrupt NR changes when operating the FADEC in single or dual engine REV mode (s).

##### NOTE

The following procedure assumes the primary and reversionary FADEC modes have failed.

When operating in the reversionary mode and the reversionary mode sustains a hard fault, REV 1 or REV 2 caution is active, a failed fixed fuel flow condition may exist. The ENG COND lever will be inoperative, therefore unable to modulate engine N1. The indications may be a change in sound, vibration absorbers may detune causing vibration, and a possible increase in NR when the THRUST CONT lever is reduced.

Two different reactions can occur depending if the engine with the failed FADEC went into fixed fuel flow at a high fuel flow or a low fuel flow.

In a high fuel flow situation, the FADEC on the non malfunctioning engine may cause the non malfunctioning engine to drop off line in an effort to maintain 100 percent NR (since the failed engine has a high fixed fuel flow). Conversely, if the failure occurred at a low power setting, the malfunctioning engine will provide little or no power upon demand. These indications must be confirmed by observing the engine instruments display since the non-malfunction engine could have low or high torque in comparison to the fixed fuel flow engine.

This fixed fuel flow condition may cause an increase in NR when THRUST CONT lever is reduced. Another indication would be a split in TQ with upward or downward THRUST CONT applications.

This fixed fuel flow condition may be capable of providing partial power at THRUST CONT application depending on the power that was required when the system sustained the hard failure.

Failure of the REV engine control system to a fixed fuel flow may require the engine to be shutdown at some point before landing to prevent NR overspeed. The ENG COND lever will be inoperative, therefore unable to modulate engine N1. The FIRE PULL handle or the manual FUEL VALVE must be used to secure the engine (if desired).

**9-15.5. **714A** REV 1 and/or REV 2 (WITH) FADEC LIGHT ON.** If a malfunction to the high side occurs, perform the following:

1. **THRUST CONT** lever — Adjust.
2. **FIRE PULL** handle (affected engine) — Pull as required.
3. **NR** — Check 100 percent.
4. Land as soon as practicable.

**9-15.6. **714A** REV 1 and/or REV 2 (WITHOUT) FADEC LIGHT ON**

1. Land as soon as practical.

##### CAUTION

**Do not manually select Reversionary mode on affected engine as uncommanded power changes may occur.**

**9-15.7. **714A** Torque Measuring System Malfunctions.**

Malfunctions in the torque measuring system can appear as a frozen indication, a zero torque indication or no indication. If a torque measuring system malfunction occurs proceed as follows:

1. DC Torque circuit breakers — In.
2. **LOAD SHARE** switch — Check. If the switch is set to TRQ, proceed to **step 3**. If the switch is set to PTIT, proceed to **step 4**.



**NOTE**

If the DECU fault code is 88, the DECU has not detected a fault in the torque measuring system and will continue to try to match the NO. 1 and NO. 2 engine torque. The DECU torque matching logic will try to increase the low engine's torque. This will cause a transient rotor speed excursion possibly up to 103% from an initial 100% selected condition. The power turbine governor will automatically bring the rotor speed back to 100%. However, a split in actual engine torque will occur as evidenced by PTIT and N1 indicators. If the DECU fault code is A1, the DECU has detected a failure of the torque measuring system and has automatically switched to N1 load share.

3. Load Share switch — Select PTIT.
4. Fuel flow — Monitor. **1896 PPH** is equal to approximately 100% torque at 100% rotor speed.
5. Verify that PTITs are matched.
6. Minimize power as practical.
7. Land as soon as practicable.

**9-16. Engine Transmission Clutch Failure to Engage.**

An engine transmission clutch failing to engage is most likely to occur when the engine condition lever is advanced from GND to FLT or during engine start. The indications of an engine transmission clutch failing to engage are: a loss of torque indication for an engine or erratic torque indications for an engine or failure of the N1

of an engine to accelerate past **70** percent N1 when advancing the ENG COND lever to FLT. A sudden high torque clutch-engagement may cause severe engine and/or drive train damage. A sudden engagement is indicated by a loud noise and/or a sudden large increase in engine torque. Should the engine transmission fail to engage, perform the following:

**WARNING**

**Do not shut down both engines simultaneously. Maintain RRPM with the engaged engine until affected engine N1 reaches zero (0).**

1. ENG COND lever (affected engine only — STOP.

*When N1 reaches zero (0):*

2. ENG COND lever (engaged engine) — STOP.

**9-17. Engine Shutdown — Complete Electrical Failure.**

- F**
1. FUEL VALVE #1 and #2 ENGINE — CLOSE.
  2. Normal shutdown — Perform.

**9-18. Engine Shutdown — Condition Lever Failure.**

Should the engine condition lever fail to shut down or control an engine, use the following procedure for engine shutdown.

1. FIRE PULL handle (affected engine) — Pull.
2. Normal shutdown — Perform.

### 9-19. Engine Shutdown with APU or APU Generator Inoperative.

#### CAUTION

When the rotors stop turning, no hydraulic pressure is available to motor the engines. In the event of internal engine fire when engine motoring cannot be accomplished, use fire extinguishing equipment as necessary to extinguish the fire.

Apply external electrical and hydraulic power (if available) and continue with a normal shutdown. If external electrical and hydraulic power is not available, proceed as follows:

1. No. 2 Engine — Perform a normal shutdown.
2. All unnecessary electrical switches (except BATT switch) — OFF.
3. GEN 1 and 2 switches — OFF.
4. ENG COND 1 lever — GND. Wait until PTIT decreases and then begins to increase; then, move the ENG COND 1 lever to STOP.
5. ENG 1 START switch — MTR until rotors stop or PTIT is below 260°C.
6. Normal shutdown — Perform.

### 9-20. Engine Oil — Low Quantity/High Temperature/High or Low Pressure.

A low engine oil quantity condition will be indicated by the lighting of the NO. 1 ENG OIL LOW or NO. 2 ENG OIL LOW caution light. When either one or both of these caution lights come on, about 2 quarts of usable oil remain in the respective engine oil tank. If one or both of the caution lights come on, check oil temperature and oil pressure indicators (affected engine) for abnormal indications. If the indication on the oil temperature indicator is high or the indication on the oil pressure indicator exceeds limits, high or low, perform the following:

1. If engine power is required for flight:  
Land as soon as possible.
2. If engine power is NOT required for flight:
  - a. ENGINE CONDITION lever (affected engine) — STOP.
  - b. Land as soon as practicable.

#### 9-20.1 Engine Chip Detector Caution Light ON.

If either NO. 1 or NO. 2 ENG CHIP DET caution light comes on, perform the following:

1. If engine power is required for flight:  
Land as soon as possible.
2. If engine power is NOT required for flight:
  - a. ENGINE CONDITION lever (affected engine) — STOP.
  - b. Land as soon as practicable.

### 9-21. ROTOR, TRANSMISSION, AND DRIVE SYSTEMS.

#### WARNING

If an interposer block or rotor blade droop stop is not in place, the flight engineer will notify the pilot in command. All non-crewmembers will evacuate the aircraft to a safe position. If possible, crew will contact maintenance and attempt to engage interposer block with a high pressure water stream or prepare aircraft for shutdown in such a way as to minimize damage to aircraft and components and prevent injury to personnel. If interposer blocks appear to be in place, the flight engineer will clear the pilot to shut down the first engine. After the first engine is shut down, the flight engineer will observe the rotor blade tip path of the forward and aft rotor heads. A rotor blade drooping significantly lower than the other blades indicates a missing droop stop. In this case the remaining running engine condition lever (ECL) should be advanced until sufficient rotor RPM is achieved to lift rotor blades off droop stops to insure no blade contact with airframe and maintenance contacted to prepare aircraft for an emergency shutdown that will minimize damage to aircraft and injury to personnel.

#### 9-22. NO. 1 or NO. 2 ENG XMSN HOT Caution.

1. EMER ENG SHUTDOWN.
- F 2. Affected engine transmission — Check.
3. Land as soon as possible.

#### 9-23. Transmission Debris Screen Latches.

Trouble developing in any of the five transmissions may be indicated by a tripped latch indicator. This information will be presented on the flight engineer's MAINTENANCE PANEL but will not be shown in the cockpit. If an indicator trips:

**FWD, COMB, or AFT DEBRIS SCREEN** indicator:

**F** RESET/GND/TEST switch — **RESET.**

*If indicator does not reset:*

Land as soon as possible.

**LEFT or RIGHT DEBRIS SCREEN** indicator:

**F** RESET/GND/TEST switch — **RESET.**

*If indicator does not reset and engine power is not required then:*

1. EMER ENG SHUTDOWN.
2. Land as soon as practicable.

*If engine power is required:*

Land as soon as possible.

#### 9-24. Transmission Low Oil Pressure or High Temperature Indications.

Developing trouble in the transmissions can be identified by high oil temperature or low oil pressure, as

indicated by transmission temperature, and pressure indicators and cautions. If an abnormal temperature or pressure indication develops, closely monitor the caution capsules. The XMSN OIL PRESS (main or aux) and XMSN OIL HOT caution capsules operate independently of the pressure and temperature indicating system and come on when a low pressure or high temperature condition occurs. Additional information may be obtained by the flight engineer checking the MAINTENANCE PANEL. The transmission temperature and pressure selector switches shall be used to assist in determining the defective transmission.

**9-25. XMSN OIL PRESS Caution.** If the XMSN OIL PRESS caution capsule comes on, the following actions should be taken:

**FWD or COMB (MIX):**

1. Altitude - Descend to minimum safe altitude.
2. Airspeed - 100 KIAS or Vne whichever is slower.
3. Land as soon as practicable.

**AFT or AFT SHAFT (confirm AFT SHAFT with flight engineer):**

**Land as soon as possible.**

**LEFT or RIGHT**

*Engine power is not required.*

1. EMER ENG SHUTDOWN.
2. Land as soon as practicable.

*Engine power is required:*

**Land as soon as possible.**

**9-26. XMSN OIL PRESS and XMSN AUX OIL PRESS or XMSN CHIP DET Caution.**

**Land as soon as possible.**

**9-27. XMSN AUX OIL PRESS Caution.** If the XMSN AUX OIL PRESS caution capsule comes on, the following actions should be taken:

**MAIN XMSN (FWD, COMB (MM), or AFT)**

*Main transmission oil pressure and temperature are abnormal:*

**Land as soon as possible.**

*Main transmission oil pressure and temperature are normal:*

Land as soon as practicable.

**9-28. XMSN OIL HOT Caution.** If the XMSN OIL HOT caution capsule comes on, the following actions should be taken:

**FWD or COMB (MIX):**

**Land as soon as possible.**

AFT transmission is indicated:

1. **Electrical load - Reduce as much as possible.**
2. **Land as soon as possible.**

**LEFT or RIGHT**

Engine power is not required:

1. **EMER ENG SHUTDOWN.**
2. Land as soon as practicable.

*Engine power is required:*

**Land as soon as possible.**

**9-28.1. Torque Measuring System Malfunctions.**

Malfunctions in the torque measuring system can appear on the torquemeter as fluctuations, zero torque indication, sluggish movement, indications that are out-of-phase, or a stationary indication. Fluctuations in torque at steady state are indicative of an electrical malfunction within the system. If this occurs, proceed as follows:

1. AC and DC TORQUE circuit breakers - In
2. NIs - Monitor when power changes are made, insuring power outputs are matched.
3. Fuel flow indicator - Monitor for matched fuel flows.
4. Land as soon as practicable.

**9-29. FIRE.**

The safety of helicopter occupants is the primary consideration when fire occurs; therefore, it is imperative that every effort be made by the flight crew to put out the fire. On the ground, it is essential that engines be shut down, crew and passengers be evacuated, and fire fighting begun immediately. If the helicopter is **airborne** when fire occurs, the most important single action that can be taken by the pilot is to **land as soon as possible**. Whether on the ground or inflight it is mandatory that the **cockpit windows, air control handles, and cockpit air knobs be closed** to prevent smoke entering the cockpit, unless the smoke and fume elimination procedure has been executed. **In flight the pilot should execute the smoke and fume elimination procedure as necessary** to prevent smoke and fumes from entering the cockpit. Fire extinguishers should be used to control or extinguish the fire.

**WARNING**

**Use fire extinguisher only in well-ventilated areas because the toxic fumes of the extinguisher agent can cause injury.**

**9-30. ENGINE HOT START.** A hot start will be detected by a rapid and abnormal rise in PTTT and/or by observing flames and black smoke coming from the engine tail cone. Complete the following on the affected engine.

1. **ABORT START.**

**9-30.1. RESIDUAL FIRE DURING SHUTDOWN.** residual engine fire may occur during shutdown. It is caused by residual fuel igniting in the combustion chamber.

1. **ABORT START.**
2. **FIRE PULL handle (affected engine) - Pull.**

**9-31. Auxiliary Power Unit (APU) Fire.** Normally an overtemperature condition will cause the overtemperature switch to stop APU operation; however, should a fire occur in the APU, complete the following:

1. **APU switch - OFF.**
2. **ABORT START.**

**NOTE**

Immediately motor engines alternately, until rotors are stopped, to reduce the possibility of engine residual fire.

**9-32. Engine or Fuselage Fire - Flight.** Visible flames, smoke coming from the engine or the lighting of the respective FIRE PULL handle:

1. **Land as soon as possible.**
- F 2. **Engine fire confirm.**
3. **EMER ENG SHUTDOWN** (affected engine)



After landing:

**EMER ENG SHUTDOWN.**

**9-33. Engine Compartment, Fuselage, or Electrical Fire - Ground.**

1. **EMER ENG SHUTDOWN.**
2. **APU switch - OFF** (if operating).
3. **BATT switch - OFF.**

**9-34. Electrical Fire - Flight.** Before shutting off all electrical power, the pilot must consider the equipment that is essential to the current flight regime; e.g. flight instruments, flight control systems, IMC etc. If a **landing as soon possible** cannot be made, defective circuits may be isolated by selectively turning off electrical equipment and/or pulling out circuit breakers.

**WARNING**

A dual engine flameout may occur if both generator switches are turned off above 6,000 feet PA. All fuel boost pumps will be inoperative.

1. **Airspeed - 100 KIAS or Vne whichever is slower.**

**NOTE**

LCT and DASH actuators will remain programmed at the airspeed at which the generators were turned off. Normal engine trim is disabled when generators are turned off.

2. **GEN 1 and 2 switches -OFF.**
3. **Land as soon as possible.**

After landing:

4. **EMER ENG SHUTDOWN.**
5. **BATT switch - OFF.**

**9-35. Smoke and Fume Elimination.**

1. **Airspeed - Above 60 KIAS.**
2. **Pilot's sliding window - Open.**
3. **Helicopter attitude - Yaw left, one half to one ball width** on turn and slip indicator.
4. **Upper half of main cabin door - Open.**

**WARNING**

The cargo ramp can be opened or closed either manually by the flight engineer using the lever on the ramp control valve or electrically by the pilot using the RAMP EMER control switch on the overhead HYD panel. If the flight engineer is unable to manually position the ramp, the pilot should attempt to check that the ramp is clear of personnel and equipment before opening or closing it. Unannounced opening or closing of the ramp may lead to injury to personnel, or damage to equipment.

5. **RAMP EMER - As required.**

**NOTE**

The combination of steps 2, 3, and 4 effectively evacuates the cockpit and forward cabin of smoke and fumes at airspeeds above 60 KIAS. Opening the cargo loading ramp evacuates the main cabin. With items in steps 2, 4, and 5 opened, intensification of a smoldering fire may occur. If the source of the fire cannot be determined, close the cargo loading ramp but keep the pilots windows and the upper half of the main cabin door open. This will allow the pilots to see the instrument panels and outside references for landing

6. Copilot's sliding window - Closed.
7. NVG curtain - Open (if applicable).

**9-36. FUEL SYSTEM.**

**9-37. Aux Fuel Pump Failure.**

An auxiliary fuel pump failure will be indicated by an AUX PRESS indicating light, on the FUEL CONTROL panel, illuminating and/or the fuel quantity in the affected tank remaining at the same level. Should this occur, proceed as follows:

1. FUEL QUANTITY selector switch - Check.

*If one or both auxiliary fuel tanks have fuel remaining:*

2. AC-DC FUEL PUMP circuit breakers - Check in.
3. FWD and AFT AUX FUEL PUMP switches (affected side) - OFF.
4. AUX FUEL PUMP switch - ON (each aux tank with fuel remaining).

*If AUX PRESS indicating light remains on:*

5. AUX FUEL PUMP switch(es) (inoperative pump(s) ) - OFF. Monitor FUEL QUANTITY indicator for the affected tank.
6. AUX FUEL PUMP switch(es) - ON for operative pumps or Off for inoperative pumps.

**9-38. Fuel Venting.**

Fuel venting from either main tank vent indicates a possibility of fuel cell overpressurization. Should venting occur:

1. **AUX FUEL PUMP switches (affected side) - OFF.**
2. Main tank (affected side) - Monitor.

*When 1,000 pounds of fuel remain:*

3. AUX FUEL PUMP switches - ON (monitor fuel quantity).

When tank quantity reaches 1,600 pounds:

4. AUX FUEL PUMP switches — OFF.
5. Steps 2 through 4 — Repeat until auxiliary tanks are empty.

**9-39. L or R FUEL PRESS Caution.**

If both main tank fuel pumps fail, fuel will be drawn from the main tanks as long as the helicopter is operated below 6,000 feet pressure altitude. If the L or R FUEL PRESS caution comes on.

1. XFEED switch— **OPEN** (above 6000 feet PA).
2. FUEL PUMP(S) circuit breakers — Check in.

*Pump(s) are operational -Proceed with step 3.*

*Pump(s) are not operational-Proceed with step 4.*

3. XFEED switch — CLOSED.
4. FUEL PUMP switches — OFF (inoperative pump(s)).

**9-40. Fuel Low Caution.**

If a L FUEL LOW or R FUEL LOW caution comes on, perform the following:

1. Fuel quantity — Check individual tanks.
2. XFEED switch — As required.
3. Land as soon as practicable.

**9-41. FUEL LOW and FUEL PRESS Cautions.**

If the FUEL LOW and FUEL PRESS cautions come on perform the following:

**WARNING**

**Failure of main tank fuel boost pumps with the crossfeed open and a fuel low condition may result in a dual engine flameout. Nose low attitude should be avoided.**

1. XFEED — CLOSED.
2. Land as soon as Possible.

**9-42. ELECTRICAL SYSTEM.**

**9-43. NO. 1 or NO. 2 GEN OFF Caution.**

**NOTE**

If either an AC or DC system fails with no bus tie, the hydraulic oil cooler fans will not function.

If only the NO. 1 or NO. 2 GEN OFF caution is illuminated, a bus exists.

1. GEN switch — OFF RESET, then ON.

If *the caution remains on:*

2. GEN switch — OFF.
3. Land as soon as practicable.

If any other system caution comes on or a system is lost, a bus tie does not exist. The primary caution segment lights to look for in determining whether or not a bus tie exists are L and R FUEL PRESS, NO.1 and NO.2 RECT OFF, and NO.1 AND NO.2 AFCS OFF.

If no bus tie exists and a generator cannot be restored:

**Land as soon as possible.**

**9-44. NO. 1 and NO. 2 GEN OFF Cautions.**

Should both generators fail, both transformer-rectifiers will also be disabled. This condition will be indicated by loss of both AFCS (which can result in abrupt attitude changes) the lighting of both AFCS OFF, GEN OFF, and RECT OFF caution. Since there will be a loss of all primary attitude, instrument, navigation, and stabilization systems, the primary concern is to restore electrical power. The only electrical power available will be 24-volt DC from the battery.

**CAUTION**

**If both generators fail, the main tank boost pumps will be inoperative. If flight is conducted above 6,000 feet PA, descend below 6,000 feet PA as soon as possible to avoid a dual engine flameout. If applicable, reduce airspeed to 100 KIAS or Vne, whichever is slower. 712 Also all normal beep trim functions will be inoperative. EMERG ENG TRIM switch for both engines should be placed to manual. The control of engine RPM will be accomplished via the EMERG ENG TRIM 1 and 2 switches. LCT and DASH actuators will remain programmed at the airspeed at which the generators failed.**

If both generators fail, perform the following:

1. AFCS SYSTEM SEL switch — **OFF.**
2. PDPs — **Check circuit breakers and gang bar down.**
3. Each GEN switch — **OFF RESET, then ON.**

*Electrical power is restored (from either generator):*

1. PDP's — **Gang Bar Up.**
2. Land as soon as practicable.

*Electrical power is not restored:*

1. APU — **Start.**
2. APU GEN — **ON.**
3. Land as soon as possible.

**NOTE**

Regardless of which condition exists, (one or both main generators inoperative) the defective generator(s) must be left OFF. If the fault is cleared and power is restored and a generator switch was unintentionally left ON unanticipated transients in the helicopter may occur.

9-45. NO. 1 or NO. 2 RECT OFF Caution.

**NOTE**

If a DC bus-tie does not occur (No. 2 Rect Off), power to open the cargo hooks in normal mode is not available and the associated hydraulic cooler fan will not function. Other cautions will be on, such as L FUEL PRESS (if crossfeed valves are closed).

*DC bus tie has occurred (only the RECT OFF caution will be on).*

1. PDPs - Check.
2. Land as soon as practicable.

*DC bus tie has not occurred.*

**Land as soon as possible.**





**9-46. NO. 1 and NO. 2 RECT OFF Cautions**

When both transformer-rectifiers (TR) fail, all equipment on the No. 1 and No. 2 DC buses will be disabled. Equipment which will be lost includes all fuel boost pumps, both AFCS, accompanied by abrupt attitude change, and both torque indicators. **712** Normal engine beep trim is also disabled, therefore, changes in power settings should be minimized. The only source of DC power is the battery.

**CAUTION**

If both transformer rectifiers have failed, the main tank boost pumps will be inoperative. If flight is conducted above 6,000 feet PA, a descent below 6,000 feet PA must be initiated as soon as possible to avoid a dual engine flameout. If applicable, airspeed should be reduced to 100 KIAS or V<sub>ne</sub>, whichever is slower. LCT and DASH actuators will remain programed at the airspeed at which the transformer rectifiers failed. **712** All normal engine beep trim functions will be inoperative. The control of engine RPM will be accomplished via the EMERG ENG TRIM 1 and 2 switches once the EMERG ENG TRIM guarded switch is at MANUAL.

If both transformer rectifiers fail, perform the following:

1. AFCS SYSTEMS SEL switch – OFF.
2. PDPs – Check circuit breakers and gang bars down.
3. DC equipment not required – OFF or pull out circuit breakers.
4. Land as soon as possible.

**9-47. BATT SYS MAL Caution.**

1. BATT CHGR circuit breaker – Out, then in.

If the BATT SYS MAL caution remains on:

2. BATT switch – OFF.

**9-48. HYDRAULIC SYSTEMS.****9-49. Hydraulic System.****WARNING**

The power transfer pumps were designed for ground checkout of the flight control system and have the capacity to pressurize the system for gentle maneuvers only. Rapid control inputs must be avoided to preclude upper boost actuator stalling (binding) and/or jam button extensions. Use of the power transfer pumps in flight is restricted to these emergency conditions only.

**9-50. NO. 1 or NO. 2 HYD FLT CONTR Caution.**

Fluid loss is evident:

Land as soon as possible.

Fluid loss is not evident:

1. PWR XFER 1 and 2 switch (affected system) – ON.
- F 2. MAINTENANCE PANEL – Monitor.
3. Land as soon as possible.

High fluid temperature is evident:

Land as soon as possible.

**9-51. NO. 1 and NO. 2 HYD FLT CONTR Caution.**

If both hydraulic systems fail, flight controls cannot be moved. In addition, the NO. 1 and NO. 2 AFCS-OFF caution will illuminate. Both AFCS systems must be turned OFF as soon as possible.

1. PWR XFER 1 and 2 switches – ON.
2. Land as soon as possible.

**9-52. UTIL HYD SYS Caution.**

Depending upon the nature and location of the system failure, it may not be possible to operate the following items of equipment: APU, engine starters, ramp and cargo door, wheel brakes, swivel locks, power steering, cargo hook, PTUs and winch. Should a failure occur in any of these subsystems:

Fluid loss is evident:

1. Isolation switch – OFF.
2. Land as soon as possible.

High fluid temperatures is evident:

Land as soon as possible.

Fluid loss is not evident:

1. APU – Start.
2. Land as soon as practicable.
- F 3. MAINTENANCE PANEL – Monitor.

**9-53. Emergency Descent.****CAUTION**

In executing any emergency descent, regardless of energy power available, it is imperative that the helicopter be maneuvered into a position from which a survivable landing can be accomplished. Transition from the following descent techniques into an appropriate landing attitude / airspeed / R/D should begin prior to descending below 600 feet AGL. The emergency descent procedures below will result in R/D which exceed the rates displayed on the VSI.

An emergency descent is a maximum performance maneuver in which damage to the helicopter or power plants must be considered secondary to getting the

helicopter on the ground. No one procedure can be considered the best for all given situations. The pilot must consider his flight profile in selecting the emergency descent procedure he will execute. RRPM greater than 102 percent significantly increases airframe vibration and should serve as a good RRPM cue during the maneuver. The following techniques will produce the greatest IUD from higher altitude.

*High Speed Straight Ahead Descent:* This procedure produces the highest (R/D) but also produces high airspeeds which must be dissipated prior to landing. The actual touchdown area may vary from the apparent touchdown point due to the glide angle change during the initial deceleration to reduce high airspeed.

1. Thrust control - Lower. Adjust RRPM to maintain approximately **104** percent.
2. Airspeed - Adjust (approximately **130 to 150 KIAS**)
3. Recovery - Initiate at or above **600** feet AGL and decelerate to **70-80 KIAS** to enter the autorotative corridor.

#### NOTE

Allowing the RRPM to increase during deceleration will reduce the floating effect which will occur when the deceleration is initiated.

*Out-of-Trim Descent:* This procedure places the helicopter in a high R/D and allows simultaneous execution of smoke and fume elimination procedure. In addition, it allows good landing area predictability.

1. Thrust control - Lower. Adjust RRPM to maintain approximately **104** percent.
2. Airspeed - Adjust to maintain approximately **100 KIAS**.
3. Trim - Adjust cyclic and pedals to obtain a minimum of **one** ball width out of trim to the right (left pedal forward) equivalent to a bank angle of approximately **8 to 10** degrees right and a zero turn rate.
4. Recovery - Initiate at or above **600** feet AGL. retrim the ball to centered flight and adjust airspeed to approximately **70 KIAS**

*Low Speed Maneuvering Descent.* Maneuvering the helicopter in steep turns as described below should allow the pilot to fly the helicopter over his intended area during the descent, observe his area of intended touchdown, and make adjustments as required.

1. Thrust control - Lower. Adjust RRPM to maintain approximately **102** percent.
2. Airspeed - Adjust airspeed to maintain **70 to 90 KIAS**.
3. Bank angle - Adjust as required. Bank angles of up to **60** degrees will result in the desired rates-of-descent.

4. Recovery - Initiate at or above **600** feet AGL. Helicopter should be returned to wings level.

#### 9-54. Autorotative Landing.

a. An autorotative landing will be accomplished after failure of both engines. Maintain speed at or above the minimum (R/D) airspeed in autorotation with CyCliC. Maintain RRPM below **108** percent by adjusting thrust as necessary. Do not allow RRPM to decay below **91** percent prior to deceleration for touchdown.

b. At approximately **50 to 75** feet above ground level, apply aft cyclic control as necessary (not to exceed **20°** nose-high attitude) to initiate a smooth deceleration. Maintain alinement of the helicopter with the landing area by application of pedals and cyclic control. Position thrust as required to prevent RRPM from increasing above the maximum.

c. At approximately 15 feet aft gear height, apply sufficient thrust to slow the R/D, assist deceleration, and effect a smooth touchdown in ETL. The amount of thrust applied and the rate at which it is applied will vary depending upon the wind, load, and other influencing factors. Maintain the landing attitude. If possible, with cyclic and thrust until forward speed has ceased, then smoothly lower thrust until the forward landing gear touches the ground. Apply brakes as required.

d. Whenever a touchdown into the wind under fully controlled conditions cannot be made, execute a crosswind landing. It is better to perform a crosswind landing, which can be executed from sufficient altitude to stop drift and reduce the R/D, than to continue a turn into the wind with the great possibility of a hard landing and damage to the helicopter. Decelerate the helicopter at the same altitude as though the helicopter were making the entire approach into the wind.

e. Stop all drift and perform the initial touchdown on the upwind aft landing gear. In a strong wind it may be necessary to hold the helicopter in what is, in effect, a slip by cross control.

f. After touchdown, allow the helicopter to settle on, the other landing gear. Perform the ground roll in the same manner as a landing made into the wind.

#### 9-55. Landing With One Engine Inoperative.

When committed to a S/E landing, it is sometimes possible to terminate the approach at a hover; however it is recommended that a running landing or an approach which terminates on the ground be used if terrain conditions allow.

#### 9-56. Landing in Trees.

External cargo must be jettisoned as soon as possible if a landing in trees is imminent, it IS important to stop the forward motion of the helicopter before entry into the trees.

Power on:

1. Approach to a hover - 5 to 10 feet.

2. EMER ENG SHUTDOWN.

3. AUTOROTATE.

Power off

AUTOROTATE.

**9-57. Emergency Entrance.**

a. Access to the cockpit is through the pilot and copilot jettisonable doors. (Figure 9-2.)

b. Entry to the cargo compartment can be accomplished by opening the cabin door, upper cabin door escape hatch, cabin escape hatch, ramp escape hatch, and cutout panels. All escape hatches can be opened by pulling out the yellow tab and pushing out the panels.

c. Entry to the aft cargo compartment maybe made by manually positioning the ramp control (exterior access to the open position).

**9-58. Ditching.**

There is sufficient buoyancy and lateral righting moment to remain afloat and upright for a sufficient length of time to permit the passengers and crew safe egress. Refer to figure 9-7 for desired ditching exits for clearing of passengers and crew.

**9-59. Ditching - Power ON.**

If ditching is to be accomplished while power is still available, plan the approach so that the final descent is made at 90° to the primary wave pattern and terminates in a hover 5 to 10 feet above the water. When stabilized in hover, discharge the passengers or wait until the helicopter is in the water and the rotors have stopped turning. If ditching becomes necessary, proceed as follows:

1. Land away from personnel in the water.
2. EMER ENG SHUTDOWN.

**9-60. Ditching - Power OFF.**

a. Maintain the desired airspeed at or above the minimum R/D airspeed and RRPM in the normal

operating range by adjusting the thrust as necessary. At approximately 100 feet above the water, perform a gradual longitudinal flare. Allow the RRPM to increase to the upper limit so that maximum benefit can be gained from the inertia to cushion the touchdown.

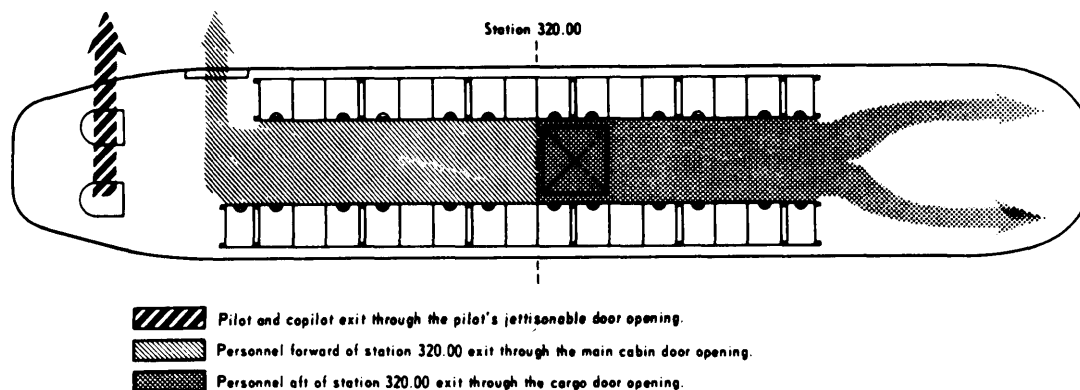
b. At approximately 30 feet above the water, the final attitude should be adjusted, not to exceed 20° nose-up. An excessive nose-up attitude will reduce the clearance between the water and the aft rotor blades and concentrate impact forces on the aft fuselage.

c. R/D should be the **minimum attainable** at water entry and must be considered regardless of water-entry speed. The water entry speed should be as slow as possible without sacrificing helicopter control.

d. Helicopter attitude at water entry is very important and relates directly to water-entry speed. At zero and up to 30 knots, the pitch attitude at water entry is dictated primarily by the clearance between the water and the aft rotor blades and should not exceed 20° nose-up. Entry speeds up to approximately 40 knots require a pitch attitude of approximately 15° to prevent high concentrated impact loads on the extreme aft bottom of the fuselage. However, it is also important not to allow the pitch attitude to become less than approximately 5° at the higher water-entry speeds since there is a possibility of breaking the lower nose enclosure plastic panels.

e. The actual touchdown on the water will probably be governed by one of the following conditions.

- (1) *High wind and rough water.* Use thrust as necessary to minimize R/D at water entry. Do not hesitate to use the remaining thrust at water entry if the R/D is judged to be excessive.
- (2) *Low wind and calm water.* Follow the procedure above to the point of the deceleration. Reduce speed to approximately 40 knots and then establish a nose-up attitude of approximately 5° to 10°. Just prior to water entry, increase thrust to cushion the aft landing gear



D145-71-10

Figure 9-7. Ditching Exits

contact with water. Attempt to have the R/D as low as possible when using this technique. As the helicopter decelerates, attempt to hold the nose out of the water. As the speed diminishes to 10 knots or less, lower the thrust control smoothly and return the controls to neutral. The helicopter does not display any tendency to pitch down upon water entry. Also, the aft landing gear acts to create a decelerating force on the water. If ditching becomes necessary:

**AUTOROTATE.**

**9-61. FLIGHT CONTROLS.**

**9-62. Longitudinal Cyclic Trim (LCT) System Failure.**

Should the system fail during cruise, with the cyclic trim system programed for maximum forward tilt of the rotors, an abnormal nose-up attitude will result with decreasing airspeed. Should one or both cyclic actuators fail in full retract position, airspeed must be limited according to Vne for retracted longitudinal cyclic trim. With both LCTs partially or fully retracted, maintain below Vne and if failure occurs extended, maintain airspeed at or above **60 KIAS** or until the approach to landing. Should the longitudinal cyclic trim system fail, perform the following:

CYCLIC TRIM circuit breakers – In. If cyclic trim operation is not restored, proceed with the procedures below for AUTO or MANUAL modes of operation.

*If in AUTO mode:*

1. **Airspeed - Adjust.**
2. CYCLIC TRIM switch – MANUAL.
3. FWD and AFT CYCLIC TRIM switches – Adjust for airspeed.

*If LCT operation is not indicated:*

FWD and AFT CYCLIC TRIM switches – RET for 30 seconds, before landing.

*If in MANUAL mode:*

1. **Airspeed - Adjust.**
2. CYCLIC TRIM switch – AUTO.

*If normal LCT operation is not indicated:*

1. CYCLIC TRIM switch – MANUAL.
2. FWD and AFT CYCLIC TRIM switches - RET both LCTs for 30 seconds before landing.

If both actuators are retracted, the landing will be normal. If one or both actuators fail in extended position, the pitch attitude of the helicopter will be higher than normal during the approach and will be dependent upon the amount of actuator extension at the time of the failure. Execute a shallow approach to a hover or to the ground with a normal touchdown, avoiding large cyclic changes. When the aft gear are on the ground, apply brakes and lower the nose. As the

forward gear touch the ground, the aircraft will tend to accelerate more than normal. Continue to apply brakes as necessary to prevent forward movement. If the helicopter is taxied with the actuators failed in the extend position, use minimum control applications and adjust the thrust control at the ground detent or higher. There is an increased susceptibility to droop-stop pounding with this condition.

**9-63. Single AFCS Failure - Both Selected.**

A malfunction of the AFCS can usually be detected by an abrupt attitude change (hardover) or unusual oscillations in one or more of the flight control axes or by lighting of the NO. 1 or NO. 2 AFCS OFF caution. If flight is conducted at low altitude such as contour or NOE, a climb to higher altitude must be initiated before the pilot attempts isolation of the defective system.

1. **Airspeed – Reduce** to 100 KIAS or Vne, whichever is slower.
2. **Altitude – Adjust** as required.

**NOTE**

A hardover in the opposite direction may occur when the malfunctioning AFCS is turned off and the functioning AFCS reacts on the flight controls.

3. AFCS SYSTEM SEL switch – Isolate defective system. Turn NO. 1 ON, if not isolated, turn NO. 2 ON.

*If system is not isolated:*

**AFCS SYS SEL** switch – **OFF.**

**9-64. Dual AFCS Failure.**

**AFCS SYSTEM SEL** switch – **OFF.**

If IMC:

Land as soon as practicable.

**9-65. Vertical Gyro (VGI) Malfunction.**

A vertical gyro malfunction will be indicated by an attitude indicator failure, an AFCS OFF caution, and attitude transients. If a vertical gyro failure occurs, proceed as follows:

**CAUTION**

**Failure of the No. 1 vertical gyro with altitude hold engaged may result in an altitude runaway. If this occurs, disengage ALT HOLD.**

**NOTE**

Failure of a vertical gyro results in loss of its associated AFCS and should be treated as a single AFCS failure.

1. Airspeed – 100 KIAS or Vne, whichever is slower.
2. Affected VGI switch – EMER.
3. AFCS – Select remaining system.

**9-66. Differential Airspeed Hold Failure (DASH).**

Differential airspeed hold failure will be recognized by pitch attitude deviations. If DASH failure occurs, avoid nose high attitudes.

**9-67. Cockpit-Control Driver Actuator (CCDA) Failure.**

1. THRUST CONT lever – Slip as required.
2. RAD ALT//BARO ALT switch – DISENGAGED.

**SECTION II MISSION EQUIPMENT**

**9-68. ARMAMENT.**

**9-69. Armament Subsystems - M24 and M41.**

**WARNING**

Do not retract the bolt assembly immediately when a hangfire or cook-off is suspected. A hangfire will normally occur within 5 seconds from the time the primer is struck. A cook-off will normally occur after 10 seconds of contact with the chamber of a hot barrel. If 150 cartridges are fired in a 2-minute period, the barrel will be hot enough to produce a cook-off.

Misfire:

- F 1. Weapon – Point at safe area.
- F 2. Bolt – Retract, remove cartridge.

**NOTE**

Keep cartridge separate from other ammunition until it has been determined whether the cartridge or the firing mechanism was at fault. If the cartridge was at fault, it will be retained separate from other cartridges until disposed of. If examination reveals that the firing mechanism was at fault, the cartridge may be reloaded and fired.

Runaway Gun:

- F Break the ammunition feed belt.

**9-70. CARGO.**

**9-71. Jettisoning External Cargo.**

**WARNING**

If a DUAL HOOK FAULT caution exists, normal and emergency release capability for the forward and aft hook may be lost. Use the manual emergency release system only. Release the center hook first, (if the helicopter is not equipped with triple release mechanism) if it loaded or safety sling is attached.

*Primary Method.*

CARGO HOOK EMERG switch – REL ALL.

**DUAL HOOK FAULT**

*Alternate Method.* Helicopter equipped with **forward and aft** emergency release lever:

- F 1. Mid hook emergency release handle (D ring) – Pull.
- F 2. Forward and aft hook release lever – Pull aft.

**NOTE**

If the forward and/or aft hooks did not open because of sling slack, apply a slight amount of thrust to load the hook(s) and force open.

**DUAL HOOK FAULT**

*Alternate Method.* Helicopters equipped with **forward, center and aft** emergency release lever.

- F Forward, center, and aft hook release lever – Pull aft.

**NOTE**

If the forward and/or aft hooks did not open because of sling slack, apply a slight amount of thrust to load the hook(s) and force open.

**9-72. Hoist.**

**WARNING**

Personnel must remain aft of the rescue hatch and face away from the cable cutter. The hoist cable may whip forward when it is cut and particles may be ejected from the cable cutter.

- 1. Personnel – Clear
- 2. CABLE CUTTER switch – ON.

**9-73 ERFS II and FARE****9-74 Failure of Fuel Quantity Gauge.**

F Remove filler cap from filler opening and look into tank. Using an explosion proof flashlight or other sealed beam light source locate fuel tabs which are attached to inside of column module at calibrated heights, in increments of 1/4, 1/2, and 3/4. Any tab covered with fuel will normally not be visible.

**9-75 F No or Slow Fuel Transfer to the Main Tanks.**

1. Manually operated fuel/defuel valve—Check CLOSED.
2. Unisex couplings—Check open.
3. Breakaway valves—Check open and for fracture.
4. Pumps—Check for operation.
5. Tank circuit breakers on FUEL CONTROL PANEL—Check reset in.
6. Ensure vent lines connected.

**9-76 F IN FLIGHT Emergency ERFS II Fuel Transfer to Main Tanks.**

*Using the FARE pump:*

1. FARE pump module to rear most ERFS II tank—Install.
2. STA 380 fuel transfer hose to rear most ERFS II tank, fuel manifold hose—Disconnect.
3. Rear most ERFS II tank fuel manifold hose coupling to FARE pump inlet (Top) coupling—Connect.
4. FARE pump module outlet (lower) coupling to STA 380 fuel transfer hose—Connect.

**NOTE**

Before FARE fuel transfer begins, a path from the desired ERFS II tank to the helicopter main tanks must be established and the fuel should be transferred from only one tank at a time.

5. "T" couplings on ERFS II tanks not being transferred—CLOSE.

**CAUTION**

There is no gauge on board the aircraft to provide measurements of GPM or PSIG. The rate at which fuel is transferred from the ERFS II tanks to the Helicopter main tanks is 20 GPM. The rate at which fuel is transferred from the ERFS II tanks using the FARE pump and standard FARE transfer hose assembly is 84 to 88 GPM. The FARE pump is rated at 120 GPM. Suction defueling pressure should not exceed -11 PSIG. Do not exceed 5 PSI except in extreme emergency. The ERFS II outer container is expected to fail at 10 PSI or greater. The crash resistant bladder will prevent fuel spillage and fuel can still be transferred.

6. FARE valve control handle OFF LOAD Position.
7. FARE pump—ON.
8. ERFS II tank manually operated fuel/defuel valve—OPEN.
9. Once ERFS II tank empties, tank fuel manifold "T" coupling—CLOSE.
10. Next ERFS II tank fuel manifold "T" coupling—OPEN.
11. Next/remaining ERFS II tank manually operated fuel/defuel valve—OPEN.
12. Once ERFS II tank empties, tank fuel manifold "T" coupling—CLOSE.
13. FARE pump—OFF.

**9-77 F FARE Pump Failure During Ground FARE Refueling Operation.**

1. Filters—Remove.
2. Overwing nozzle—Install and use.
3. Manually operated fuel/defuel valves—OPEN.

**NOTE**

If three ERFS II tanks are installed and all the in-tank pumps are on, a 60 gallon per minute rate can be achieved.

4. ERFS II tank pumps—ON.



## APPENDIX A

## REFERENCES

This appendix contains a list of official publications referenced in this manual and available to and required by CH-47D helicopter operating activities. The publications listed are directly related to flight operation and maintenance of CH-47D helicopters.

AR 70-50	Designating and Naming Military Aircraft, Rockets, and Guided Missiles
AR 95-1	Army Aviation - General Provisions and Flight Regulations
AR 95-3	Aviation - General Provisions, Training, Standardization, and Resource Management
AR 385-40	Accident Reporting and Records
DA PAM 738-751	The Army Maintenance Management System - Aviation (TAMMS-A)
FM 1-202	Environmental Flight
FM 1-230	Meteorology for Army Aviation
FM 1-240	Instrument Flying and Navigation for Army Aviators
FM 1-513	Tactics, Techniques, and Procedures for Aerial Recovery of Aircraft
FM 55-450-3/-4/-5	Multiservice Helicopter External Air Transport
FM 55450-2	Helicopter Internal Loads
TB 55-1500-334-25	Conversion of Aircraft to Fire Resistant Hydraulic Fluid
TB 55-9150-200-24	Engine and Transmission Oils, Fuels, and Additives for Army Aircraft
TM 1-1500-250-23	Technical Manual Aviation Unit and Aviation Intermediate Maintenance for General Tie-Down and Mooring on all Series Army Models AH-64, UH-60, CH47, UH-1, AH-1, OH-58 Helicopters
TM 9-1005-224-10	Machine Gun, 7.62 MM, M60
TM 11-5810-262-OP	Operating Procedures for Cryptographic Speech Equipment TSEC/KY-58
TM 11-5810-281-OP	Operating Procedures for Cryptographic Speech Equipment TSEC/KY-75
TM 11-5841-294-12	Operator and Aviation Unit Maintenance Manual for Radar Signal Detecting Set AN/APR-39A(V)1
TM 11-5855-300-10	Operating Procedures for Heads Up Display AN/AVS-7
TM 11-5895-1199-12	Operator's and Organizational Maintenance for Mark XII IFF System (AN/APX-100, AN/APX-72)
TM 38-250	Preparation of Hazardous Materials for Military Aircraft
TM 55-1500-204-25/1	General Aircraft Maintenance Manual
TM 55-1500-342-23	Army Aviation Maintenance Engineering Manual: Weight and Balance
TM 55-1520-240-CL	Operators and Crewmembers Checklist
TM 55-1520-240-23	Aviation Unit and Aviation Intermediate Maintenance Manual
TM 55-1680-358-12&P	Operator and Aviation Unit Maintenance Instructions for Helicopters Internal Cargo Handling System
TM 750-244-1-5	Procedures for the Destruction of Aircraft and Associated Equipment to Prevent Enemy Use

## APPENDIX B GLOSSARY

Abbreviation	Term	Abbreviation	Term
AC	Alternating Current	CHAN	Channel
ACK	Acknowledge	CHK	Check
ACTR	Actuator	CKPT	Cockpit
ADF	Automatic Direction Finding	CL	Checklist
AFCS	Advanced Flight Control System	CL	Center Line
AGL	Above Ground Level	CLR	Clear
AIMS	Air traffic control radar beacon system Identification friendly or foe Mark XII identification System	CLR-VC	Clear Voice
AJ	Anti-Jam	CM	Countermeasures
AK	Automatic Keying	CMD	Command
ALP	Alpha	CNV	Crypto Net Variable
ALSE	Aviation Life Support Equipment	COMM	Communication
ALT	Altitude	COMP	Compass
AM	Amplitude Module	COMPT	Compartment
AME	Amplitude Modulation Equivalent	COND	Condition
AMP	Ampere	CONT or	
ANT	Antenna	CONTR	Control
ACK	Acknowledge	COPLT or	
ANVIS	Aviation Night/Vision Imaging System	CPLT	Copilot
APU	Auxiliary Power Unit	CPDU	Copilot display unit
APPROX	Approximately	CPM	Control processor and communication
AR	Army Regulation	CRS	Course
AS	Airspeed	CRT	Cathode Ray Tube
ASTM	American Society for Testing Materials	CTR	Center
ATM	Aircrew Training Manual	CW	Continuous Wave
AUTO	Automatic	DA	Density Altitude
AUX	Auxiliary	DASH	Differential Airspeed Hold
AVAIL	Available	DAT	Data
AVGAS	Aviation Gasoline	DC	Direct Current
BARO	Barometric	DCLT	Declutter
BATT or		DCP	Differential Collective Pitch
BTRY	Battery	DEC	Decrease
BCN	Beacon	DEST	Destination
BFO	Beat-Frequency Oscillator	DET or	
BIT	Built in Test	DETR	Detector
BITE	Built in Test Equipment	DF	Direction Finder
BL	Butt Line	DIM	Dimensions
BRK	Brake	DIS	Disable
BRT	Bright	DISCH	Discharge
BRG	Bearing	DISP	Display or Dispenser
BTU	British Thermal Unit	DIST	Distance
C	Celsius	DN	Down
CAS	Calibrated Airspeed	DOP	Doppler
CCR	Closed Circuit Refuel	DSPL	Display
CCU	Converter control unit	DU	Display unit
CDR's	Commander's	E	East
CDU	Computer display unit or control display unit	EAPS	Engine Air Particle Separator
C.G.	Center-of-Gravity	ECM	Electronic Countermeasure
CGI	Cruise Guide Indicator	ECCM	Electronic Counter Countermeasures
		EDT	Edit
		EMER or	
		EMERG	Emergency
		ENG	Engine
		ENT	Enter

Abbreviation	Term
ERFS .....	Extended Range Fuel System
ERFS II .....	Extended Range Fuel System II
ETL .....	Effective Translational Lift
EXH .....	Exhaust
EXT .....	Extend, Extinguisher, or External
F .....	Fahrenheit
FARE .....	Forward Area Refueling Equipment
FAT .....	Free Air Temperature
FCP .....	Fuel Control Panel
FH .....	Frequency Hopping
FIG .....	Figure
FIL .....	Filament
FL .....	Flow
FLP .....	Flight Plan
FLT .....	Flight
FLT CONT ..	Flight Control
FM .....	Frequency Modulated
FMCP .....	Fuel Management Control Panel
FM-M .....	Frequency Hopping Master
FMT .....	Frequency Managed Training
FOD .....	Foreign Object Damage
FPM or FT/	
MIN .....	Feet Per Minute
FREQ or	
FRQ .....	Frequency
FT .....	Feet
FUSLG or	
FUS .....	Fuselage
FWD .....	Forward
G .....	Green
G's .....	Gravity
GALS .....	Gallons
GCA .....	Ground Controlled Approach
GD XMIT ...	Guard Transmitter
GEN .....	Generator
GMT .....	Greenwich Mean Time
GND .....	Ground
GPM .....	Gallons per Minute
GS .....	Glide Slope
GS/TK .....	Ground Speed/Track
GW .....	Gross Weight
GYRO(s) ...	Gyroscope(s)
H .....	High
HDG .....	Heading
HF .....	High Frequency
Hg .....	Mercury
HGT .....	Height
HI .....	High
HICHS .....	Helicopter Internal Cargo Handling System
HIGE .....	Hover In Ground Effect
HIT .....	Health Indicator Test
HOGE .....	Hover Out of Ground Effect
HR .....	Hour
HSI .....	Horizontal Situation Indicator
HTG .....	Heating

Abbreviation	Term
HTR .....	Heater
HUD .....	Heads up display
HYD .....	Hydraulic
Hz .....	Hertz
I .....	Inner
IAS .....	Indicated Airspeed
ICS .....	Intercommunication System
ID or	
IDENT .....	Identification
IFF .....	Identify Friend or Foe
IFR .....	Instrument Flight Regulations
IGE .....	In Ground Effect
IGN .....	Ignition
ILCA .....	Integrated Lower Control Actuator
ILS .....	Instrument Landing System
IMC .....	Instrument meteorological conditions
IN. or " .....	Inch
INC. ....	Increase
IND .....	Indicator
INOP .....	Inoperative
INST .....	Instruments
INT or	
INPH .....	Interphone
INTR .....	Interior
ITO .....	Instrument Takeoff
JP-4, JP-5 or	
JP-8 .....	Jet Petroleum
K .....	Key
KYBD .....	Keyboard
kHz .....	Kilohertz
KIAS .....	Knots Indicated Airspeed
Km .....	Kilometer
KN or KTS ..	Knots
L .....	Left
LAT/LONG ..	Latitude/Longitude
LB .....	Pound(s)
LB-FT .....	Pound-Feet (Torque)
LB/GAL .....	Pounds Per Gallon
LB/HR .....	Pounds Per Hour
LBL .....	Left Butt Line
LCT .....	Longitudinal Cyclic Trim
LD .....	Load
LD-V .....	Load Variable
LF .....	Low Frequency
LG .....	Length
LH .....	Left-Hand
LO .....	Low
LOC .....	Location
LSB .....	Lower Sideband
LTG .....	Lighting
LTS .....	Lights
LVL .....	Level
M .....	Mode or Middle
MA .....	Missile Alert
MAG .....	Magnetic
MAL .....	Malfunction
MAM .....	Manual

Abbreviation	Term
MAX	Maximum
MB or MKR	
BCN	Marker Beacon
M-C	Mode C
MCW	Modulated Carrier Wave
MDL	Module
MED	Medium
MEM	Memory
MEM	
LOAD	Memory Load
MHz	Megahertz
MID	Middle
MIL	Angular Measurement, Military
MIN	Minute(s) or Minimum
MK	Manual Keying
MM	Millimeter
MOM	Momentary or Moment
MOM. ON	Momentary On
MSG	Message
MSL	Mean Sea Level or Missile
MST	Master caution
MTR	Motor
MWOD	Multiple Word of Day
N	North
NAC	Nacelle
NAV	Navigation
NB	Narrow Band
NM	Nautical Mile
NO	Number
NORM	Normal
NPU	Navigation Processor Unit
NVG	Night Vision Goggles
N1	Gas Producer (Speed)
N2	Power Turbine (Speed)
O	Outer
OBS	Omni Bearing Selector
OBST	Obstacle
OFST	Offset
OGE	Out-of-Ground Effect
ONS	Omega Navigation System
OP	Operation
OU	Optical unit
OUTB'D	Outboard
OVHD or	
OVRHD	Overhead
OVSP	Overspeed
PA	Pressure Altitude
PAM	Pamphlet
PARA	Paragraph
PDP	Power Distribution Panel
PDU	Pilot Display Unit
PGRM	Program
PH	Phase
PLT	Pilot
P/N	Part Number
PNL	Panel
POS	Position

Abbreviation	Term
PP	Present Position
PPH	Pounds Per Hour
PRESS	Pressure
PRI	Primary
PROG	Program
PS	Power supply
PSCU	Power supply calibration unit
PSF	Pounds Per Square Foot
PSI	Pounds Per Square Inch
PSIG	Pounds Per Square Inch Gauge
PT	Pint
PTIT	Power Turbine Inlet Temperature
PTT	Push-to-Talk or Press-to-Talk
PTU	Power Transfer Unit
PVT	Private
PWR	Power
QT	Quart
QTY	Quantity
R	Red
R or RT	Right
RAD	Radar
RAM	Random Access Memory
RBL	Right Butt Line
RC	Rate of Climb
RCU	Remote Control Unit
RCVR	Receiver
RD	Rate of Descent
RECP or	
REC	Receptacle
RECT	Rectifier
REF	Reference
REL	Release
REQD	Required
RET or	
RETR	Retract
Retrans or	
RE-X	Retransmission
REV CUR	Reverse Current
RF	Radio Frequency
RH	Right-Hand
RRPM	Rotor Revolutions Per Minute
RPM	Revolutions Per Minute
RV	Receive Variable
RX	Receive or Receiver
S	South
SDA	Synchro discrete and analog
SDC	Signal data converter
SDR	Symbol generator and driver
SEC	Secondary
SECT	Section
SEL	Select
SELADR	Selective Address
SENS	Sensitivity
SHP	Shaft Horsepower
SL	Sea Level
S/N	Serial Number

Abbreviation	Term
SLT	Searchlight
SP/DIR	Speed/Direction
SPEC	Specification
SPH	Spheroid
SQ	Squelch or Square
SQ DIS/	
TONE	Squelch Disable/Tone
SQ FT	Square Feet
STA	Station
STBY	Standby
STO or STR	Store
SYS	System
T/R + G	Transmit/Receive Plus Guard Channel
TACH	Tachometer
TAS	True Airspeed
TCK	Track
TGT	Target
TEMP	Temperature
TOD	Time of Day
TQ/ENG	Torque Per Engine
TX	Transmit or Transmitter
TYP	Typical
UHF	Ultra High Frequency
US	United States
USB	Upper Sideband
UTIL	Utility
UTM	Universal Transverse Mercator
V	Volt (s)
VAC	Volts Alternating Current
VAR	Variation
Vegi	Estimated Airspeed Limit with an Operating Cruise Guide Indicator
VDC	Volts Direct Current
VENT	Ventilate

Abbreviation	Term
VFR	Visual Flight Regulations
Vh	Maximum Airspeed in Level Flight (as Limited by CGI, PTIT, or Torque)
VHF	Very High Frequency
VGI	Vertical Gyro Indicator
VLF	Very Low Frequency
Vmax	Maximum Airspeed Limit (Indicator Red Line)
Vne	Velocity (Airspeed) Never Exceed
VOL	Volume
VOR	Very High Frequency Omni-Directional Range
VSI	Vertical Speed Indicator
W	West or wide
WARN	Warning
WB	Wide Band
WL	Water Line
WOD	Word of Day
WSHLD or	
W/S	Windshield
WT	Weight
X	Times or By
XFEED	Crossfeed
XFER	Transfer
XMIT	Transmit
XMSN	Transmission
XTK/TKE	Cross Track/Track Angle Error
°	Degrees or Temperature
°C	Degrees Celsius
°/KTS	Degrees Per Knots
%	Percent
3/REV	Three Vibrations for Each Revolution of The Rotor

## APPENDIX C CONDITIONAL INSPECTIONS

This appendix contains those conditions which require a write-up in DA Form 2408-13. An entry shall state the limit(s) exceeded, range, time above limits, and any additional data that would aid maintenance personnel in maintenance action that maybe required.

CONDITION	2408-13 ENTRY REQUIRED	REMARKS
Water landings have been performed.	Comment.	
Salt water landings.	Comment.	
Landing in mud or swampy terrain or difficulty in starting or torching of the cabin heater.	Comment.	
Landing gear wheels have been submerged in water or mud.	Comment.	
Helicopter has been washed or sub-jetted to heavy rain.	Comment.	
Helicopter is operated within 200 miles of volcanic activity.	Comment.	
Helicopter is operated within 10 miles of salt water or 1000 feet of its surface.	Comment.	
Fuel vents overboard or uneven tank depletion rate occurs from an auxiliary fuel tank during normal operation.	Comment.	
Fuel vents overboard from a main fuel tank during normal flight operations.	Comment.	
Whenever emergency fuel is used.	Type of fuel, additives, and duration of operation.	Operation with emergency fuel should not exceed 6 hours cumulative time.
Helicopter has been subjected to a hard landing or when emergency exit lights are actuated during landing.	Comment,	
When two different types of oil are mixed in either engine.	Comment	Respective engine oil shall be changed and the system flushed within 6 hours of engine operation.

CONDITION	2408-13 ENTRY REQUIRED	REMARKS
Engine oil consumption exceeds 2 quarts per hour.	Comment.	
Engine is subjected to sudden stoppage or a sudden reduction in RPM.	Comment.	
Engine compressor stall (surge) is experienced.	Comment.	
Each time emergency power indicator is tripped.	Comment.	
Emergency power reaches 30 minute cumulative time.	Comment.	
When starting or beeping engines, if loud noises or shocks are followed by sudden high increases in engine torque, or if a torquemeter is stationary at high value after shutdown.	Comment.	Do not restart affected engine.
When starting engines, if either engine fails to accelerate to flight speed.	Comment.	
When CO2 is applied to engine inlet or exhaust.	Comment.	
When torquemeter is stationary at a high value after shutdown.	Comment.	
When the transmission filter bypass button is extended.	Comment.	
When a transmission is suspected of excessive oil leakage.	Comment.	
When a transmission oil system has been contaminated with hydraulic fluid.	Comment.	
When two different types of oil are mixed in the forward, combiner, aft, or engine transmissions.	Comment	Respective transmission oil shall be changed and the system flushed within 6 hours of transmission operation.
When MILH-83282 hydraulic fluid is not available and MIL-H-5606 is used.	Indicate quantity added.	

CONDITION	2408-13 ENTRY REQUIRED	REMARKS
When a rotary wing blade has made contact with a foreign object or when the power train has been subjected to a sudden reduction in RRPM.	Comment.	
Helicopter is struck by lightning.	Comment.	
When a rotary wing blade has been struck by lightning.	Comment.	
When a rotary wing has been flapping due to high winds.	Comment.	
When the rotor blades are pounded against the droop stops, or have experienced violent and heavy flapping, or have been exposed to hurricane or tornadic winds.	Comment.	
When a rotary head is suspected of excessive oil leakage.	Comment.	
When internal failure (metal contamination) of a flight control or utility hydraulic pump or motor occurs.	Comment.	
When two different types of oil are mixed in the APU.	Comment	APU oil shall be changed and the system flushed within 6 hours of APU operation.
When the compass is suspected of being in error.	Comment.	
After every manual release of the center cargo hook under load.	Comment.	
When a fault indication is displayed on the MAINTENANCE PANEL.	Comment.	
When any Chapter 5 limitations have been exceeded.	Limit or limits exceeded, range, time above limits, and any additional data that would aid maintenance personnel.	





## ALPHABETICAL INDEX

<i>Subject</i>	<i>Paragraph, Figure, Table Number</i>	<i>Subject</i>	<i>Paragraph, Figure, Table Number</i>
<b>A</b>			
Abbreviations .....	B-1	Description .....	7-40
AC Cabin Utility Receptacles .....	2-135	Use of Chart .....	7-41
Accumulator Gage .....	6-49	Airspeed Hold .....	2-86
Accumulators Precharge Limits .....	F 2-54	Airspeed Indicator .....	2-194
AC System .....	2-147	<b>AIRSPEED OPERATING LIMITS</b> .....	5-20
AC Generator Cautions .....	2-149	AFCS Limitations .....	5-28
AC Power Supply (Typical) .....	F 2-38	Airspeed Limitations – Longitudinal Cyclic Trim Retracted .....	F 5-6
Electrical Power Panel .....	F 2-39	Airspeed Limitations With an Inoperative Cruise Guide Indicator .....	5-21, F 5-5
External Power Caution .....	2-150	Airspeed Limitations With Inoperative or Inoperative Cruise Guide Indicator .....	5-22
External Power Receptacles .....	F 2-36	External Cargo Airspeed Limits .....	5-23
Generator Control Switches .....	2-148	High Density Loads .....	5-25
Power Distribution Panels (Typical) .....	F 2-37	Mil-Van Type Loads .....	5-24
Additional Limitations .....	5-47	Tandem Hook Rigging With Forward Hook Redundant Sling .....	F 5-4
Air-to-Ground Towing .....	5-48	Tandem Hook Rigging Without Redundant Sling .....	F 5-3
APU Operation .....	5-49	Longitudinal Cyclic Trim (LCT) Actuator Airspeed Limits .....	5-26
Extended Range Fuel System (ERFS) .....	5-52	Air-to-Ground Towing .....	5-48
Pitot Tube and AFCS Sideslip Port Anti-Icing Limitation .....	5-50	Altimeter .....	2-195
Single Point Refueling .....	5-51	Altitude Hold .....	2-87
Advanced Flight Control System (AFCS) .....	2-83	Antenna Locations .....	F 3-3
Advanced Flight Control System Panel .....	F 2-28	Antenna System .....	3-6
AFCS Control Panel .....	2-91	Anticollision Lights .....	2-164
AFCS OFF Caution Capsules .....	2-93	ANTI COL Light Switches .....	2-165
Airspeed Hold .....	2-86	Anti-Icing Systems .....	2-122
Altitude Hold .....	2-87	ANTI ICE Panel .....	2-123
Bank Angle Hold .....	2-84	Anti Ice Panel .....	F 2-33
Command Select Switch .....	2-94	Appendix A, References .....	1-4
Controls and Indicators .....	2-90	Appendix B, Abbreviation .....	1-5
Cyclic Trim Indicators .....	2-92	Appendix C, Conditional Inspections .....	1-6
Forward and Aft Cyclic Trim Indicators .....	F 2-29	APU ON Caution .....	2-158
Heading Hold .....	2-85	APU Switch .....	2-157
Heading Select .....	2-88	Armament Subsystem .....	4-17, F 4-8
Longitudinal Cyclic Trim System .....	2-89	Machine Gun .....	4-18
Aerobatics Prohibition .....	5-29	Ammunition Can and Ejection Control Bag .....	F 4-11
Aerodynamic Loads .....	8-52	Ammunition Can – Installed .....	F 4-15
AFCS Trim Switch .....	2-81	Ejection Control Bag - Installed .....	F 4-14
After Landing .....	8-41	Machine Gun Controls .....	4-20
AGENT DISCH Switch .....	2-26	Machine Gun M60D .....	F 4-9
AIMS Altimeter .....	F 2-48	Machine Gun Positioned on Pintle – Left Side Shown .....	F 4-16
Air Control Handles .....	2-143	Machine Gun Stowed on Right Mount .....	F 4-13
<b>AIRCRAFT AND SYSTEMS DESCRIPTION AND OPERATION</b>		Right Machine Gun Mount – Installed .....	F 4-12
General .....	2-1	Ammunition .....	4-26
General Arrangement .....	F 2-1	Armament Subsystem M24 Data .....	T 4-1
Gross Weight .....	2-2	Operation – Armament Subsystem M24 .....	4-22
Principal Dimensions Diagram .....	F 2-2	Preflight Checks .....	4-23
Turning Radii .....	F 2-3	Before Takeoff Check .....	4-24
Aircraft Compartment and Loading Diagram .....	F 6-1		
Aircraft Designation System .....	1-12		
Airspeed Calibration Chart .....	F 7-98		
Conditions .....	7-42		

<i>Subject</i>	<i>Paragraph, Figure, Table Number</i>	<i>Subject</i>	<i>Paragraph, Figure, Table Number</i>
Inflight Operation .....	4-25	Cargo Center of Gravity .....	6-58
M24 Mount .....	F 4-10	Cargo Dimensions .....	6-56
Mount Assemblies (M24) .....	4-19	Cargo Door and Ramp .....	2-14, 6-45, F 6-15
Mount Assembly Stops, Cams, Quick-Release Pin, and Shock Cord (M24) .....	4-21	Pressure Actuated Valve .....	6-48
ARMAMENT SUBSYSTEM M41 .....	4-27	Ramp Operation .....	6-51
Armament Subsystem M41 Data .....	T 4-3	In-Flight Operation .....	6-53
Operation – Armament Subsystem M41 .....	4-30	Manual Operation – Cargo Door .....	6-54
Mount Assembly (M41) .....	4-28	Normal Operation .....	6-52
Mount Assembly Stops, Cams, Quick-Release Pin, and Elastic Cord (M41) .....	4-29	Ramp Controls .....	F 6-16
M41 Mount – Installed on Ramp .....	F 4-17	Ramp Control Sequence Valve .....	6-47
Armored Seats .....	2-20, F 2-13	Ramp Control Valve .....	6-46
Army Aviation Safety Program .....	1-8	Cargo Hook Cautions .....	4-44
Ash Trays .....	2-137	Cargo Hook Controls .....	4-41
Attitude Indicator .....	2-202	Cargo Hook Limitations .....	5-18
Authorized Cartridges .....	T 4-2	Cargo Hooks Operational Check .....	4-47
Auxiliary Power Unit .....	F 2-41	<b>CARGO LOADING</b>	
Emergency APU Fluid Shut Off Valve .....	F 2-42	Cargo Compartment .....	6-25
APU ON Caution .....	2-158	Cargo Compartment Dimensions .....	F 6-9
APU Switch .....	2-157	Cargo Compartment Floor .....	6-29
ELECTRONIC SEQUENCING UNIT .....	2-156	Concentrated Load Limits .....	6-34
General .....	2-155	Concentrated Loads .....	6-33
Aviation Life Support Equipment (ALSE) .....	8-2	Load Limits .....	6-35
Avionics Equipment Configuration .....	3-2	Uniformly Distributed Load Limits .....	6-32
Antenna Locations .....	F 3-3	Uniformly Distributed Loads .....	6-31
Antenna System .....	3-6	Compartment Capacities .....	6-37
Avionics Power Supply .....	3-3	Compartment Data .....	F 6-12
Communications/Navigation Equipment .....	T 3-1	Compartment Identification .....	6-36
Description .....	3-1	Compartment Loading .....	6-65, F 6-20
		General .....	6-24
		General Instructions for Loading, Securing, and Unloading Cargo .....	6-61
<b>B</b>		Restraint .....	6-63
Bank Angle Hold .....	2-84	Weight and Balance .....	6-62
Bank Angle Limitations .....	F 5-7	Lower Rescue Door .....	6-28
Bank Limitations .....	5-30	Main Cabin Entrance .....	6-26
Battery System Malfunction Caution .....	2-154	Maximum Package Size .....	F 6-10
BATT Switch .....	2-152	Utility Hatch Door .....	6-27
Before Landing .....	8-37	Cargo Loading Aids .....	6-41
Before Leaving Helicopter .....	8-43	Auxiliary Loading Ramps .....	6-43
BRK STEER Isolation Switch .....	2-101	Cargo Door Cranking .....	F 6-19
Brake System .....	2-7	Cargo Door and Ramp .....	2-14, 6-45, F 6-15
Brake Pedals .....	2-8	Cargo Loading Ramp .....	6-42
Brakes and Steering Isolation Switch .....	2-10	Winch .....	4-31, 6-44
Parking Brake Handle .....	2-9	<b>CAUTION LT Panel</b> .....	2-216
Steering and Swivel Lock System .....	2-5	Center Console (Typical) .....	F 2-6
Steering Control Panel .....	2-6, F 2-5	Center Cargo Hook .....	4-38
Bulk Cargo Tiedown .....	6-75	Center Cargo Hook and Cargo Hook Release .....	F 4-30
		Center Cargo Hook Loading Pole .....	4-39, F 4-29
<b>C</b>		<b>CENTER HOOK LOADS</b> .....	8-49
CABIN AND RAMP LIGHTS Switches .....	2-185	Aerodynamic Loads .....	8-52
Cabin and Lamplights .....	2-184	High Density Loads .....	8-51
Cabin Heat Controls .....	2-144	Low Density Loads .....	8-50
Cabin Lighting and Controls .....	F 2-45	Multi-Hook Loads .....	8-53
Canted Console (Typical) .....	F 2-7	Center Instrument Panel Lights .....	2-174
Canted and Center Console Lights .....	2-176		

<i>Subject</i>	<i>Paragraph Figure, Table Number</i>
Center Instrument Panel (Typical) . . . . .	F 2-9
CENTERING DEVICE RELEASE Switch . . . . .	2-80
Center-of-Gravity Limitations . . . . .	5-16
C.G. Limits Chart . . . . .	F 6-25
CGI TEST Switch . . . . .	2-193
Change Symbol Explanation . . . . .	1-11
Checklist . . . . .	8-9
CHRONOMETER . . . . .	2-207
Chronometer . . . . .	F 2-50
Normal Operation - CHRONOMETER . . . . .	2-208
Setting ET . . . . .	2-211
Setting GMT . . . . .	2-209
Setting LT . . . . .	2-210
Test Mode . . . . .	2-212
Classification of Helicopter . . . . .	6-3
Climb - Descent Chart . . . . .	F 7-94
Climb Performance . . . . .	F 7-95
Conditions . . . . .	7-36
Description . . . . .	7-34
Use of Charts . . . . .	7-35
Climb . . . . .	8-34
Cockpit Air Knob . . . . .	2-142
Cockpit Lighting and Control . . . . .	F 2-44
Cockpit Rearview Mirror . . . . .	2-132
Cockpit Utility Receptacles . . . . .	2-134
Cockpit and Controls . . . . .	F 2-4
COLD WEATHER OPERATION . . . . .	8-54
After Landing . . . . .	8-69
Before Leaving Helicopter . . . . .	8-71
Descent . . . . .	8-67
During Flight . . . . .	8-66
Engine Shutdown . . . . .	8-70
Engine Starting . . . . .	8-62
Warmup and Ground Tests . . . . .	8-63
General . . . . .	8-55
Heater Operation . . . . .	8-57
Landing in Snow . . . . .	8-68
Preparation for Flight . . . . .	8-56
Takeoff . . . . .	8-65
Taxiing . . . . .	8-64
Combining and Engine Transmission Lubrication Systems . . . . .	2-111
Command Select Switch . . . . .	2-94
Compass Correction Card Holder . . . . .	2-138
Continuous Torque Available . . . . .	7-19, F 7-5
Conditions . . . . .	7-21
Use of Chart . . . . .	7-20
Copilot Instrument Panel (Typical) . . . . .	F 2-8
Countermeasures Set (AN/ALQ-156) . . . . .	4-5
Controls and Indicators, Missile Detector Set (AN/ALQ-156) . . . . .	4-6
Countermeasures Set Control Panel (AN/ALQ-156) . . . . .	F 4-6
Normal Operation; Countermeasure Set . . . . .	4-7
Crew Briefing . . . . .	8-4
Crew Duties/Responsibilities . . . . .	8-3
Cruise Charts . . . . .	7-30
Conditions . . . . .	7-30
Description . . . . .	7-28

<i>Subject</i>	<i>Paragraph Figure, Table Number</i>
Example Cruise Chart . . . . .	F 7-9
Use of Charts . . . . .	7-29
Cruise Check . . . . .	8-35
CRUISE GUIDE Indicator . . . . .	2-192
Cruise Guide Indicator . . . . .	F 2-47
Cruise Guide Indicator System . . . . .	2-191
CTR INST Switch . . . . .	2-175
Cyclic Stick . . . . .	2-79
Cyclic Stick Grip . . . . .	F 2-27
Cyclic Trim Indicators . . . . .	2-92
<b>D</b>	
DC Cabin Utility Receptacles . . . . .	2-136
DC System . . . . .	2-151
BATT Switch . . . . .	2-152
Battery System Malfunction Caution . . . . .	2-154
DC Power Supply (Typical) . . . . .	F 2-40
Transformer Rectifier Cautions . . . . .	2-153
DD Form 365-3 Chart C - Basic Weight and Balance Record . . . . .	6-4
DD Form 365-4 (Weight and Balance Clearance Form F) . . . . .	6-5
DESCENT . . . . .	8-36
DESERT AND HOT WEATHER OPERATION . . . . .	8-72
Before Leaving the Aircraft . . . . .	8-80
Engine Shutdown . . . . .	8-79
Engine Starting . . . . .	8-75
General . . . . .	8-73
Landing . . . . .	8-78
Preparation for Flight . . . . .	8-74
Takeoff, Climb, Cruise, and Descent . . . . .	8-77
Taxiing . . . . .	8-76
Destruction of Army Material to Prevent Enemy Use . . . . .	1-9
Direction Finder Set (AN/ARN-89) . . . . .	3-27
Controls and Function Direction Finder Set (AN/ARN-89) . . . . .	3-28
Direction Finder Control . . . . .	F 3-10
Normal Operation - Direction Finder Set . . . . .	3-29
Directional Gyro (CN-998/ASN-43) . . . . .	F 3-12
Directional Pedals . . . . .	2-82
Dome Lights . . . . .	2-178
DOME Switch . . . . .	2-179
Doppler Navigation Set (AN/ASN-128) . . . . .	3-33
Computer-Display Unit Data Displays . . . . .	T 3-3
Controls and Function - Doppler Navigation Set . . . . .	3-34
Data Entry . . . . .	3-36
Dead Reckoning Navigation . . . . .	3-52
Display and Keyboard Operation . . . . .	3-35
Doppler Navigation Set Control (AN/ASN-128) . . . . .	F 3-13
Entering Data . . . . .	3-38
Entering Ground Speed and Track . . . . .	3-42
Entering Present Position or Destination in LAT/LONG . . . . .	3-41
Entering Spheroid and/or Variation . . . . .	3-39
Flight Procedures . . . . .	3-44

<i>Subject</i>	<i>Paragraph Figure, Table Number</i>
FLY-TO-DEST Operation .....	3-47
Left-Right Steering Signals .....	3-48
Transferring Stored Target Coordinates from One Location to Another .....	3-50
Transferring Variation from One Location to Another .....	3-51
Update of Present Position from Landmark	3-46
Update of Present Position from Stored Destination .....	3-45
Operation During and After Power Interruption .....	3-53
Spheroid Data Codes .....	T 3-4
Starting Procedure .....	3-37
Stopping Procedure .....	3-54
System Initialization .....	3-43
Target Store (TGT STR) Operation .....	3-49
Doppler/GPS Navigation Set	
AN/ASN-128B (DGNS) .....	3-61.1
CDU Operation .....	3-61.8
Controls and Indicator	
- Horizontal Situation Indicators .....	3-61.15
Controls, Displays and Function .....	3-61.2
Doppler/GPS Navigation System	
AN/ASN-128B .....	F 3-15.1
Flight Procedures .....	3-61.13
Fly-To Destination Operation .....	3-61.14
General Operating Procedures for Entering Data .....	3-61.11
GPS Landing Mode .....	3-61.7
Graphic Definition of Course Terms ..	F 3-15.2
Horizontal Situation Indicator Mode Select Panel .....	3-61.16
Horizontal Situation Indicator Mode Select Panel .....	F 3-15.3
Modes of Operation .....	3-61.3
Navigate Mode .....	3-61.5
Combined Mode (Default or Primary Mode of Operation) .....	3-61.5.1
Doppler Mode .....	3-61.5.3
GPS Mode .....	3-61.5.2
Off Mode .....	3-61.4
Preflight Procedures .....	3-61.12
Route Sequencing Modes .....	3-61.9
Test Mode .....	3-61.6
To-To Route Modes .....	3-61.10
Drag Chart .....	F 7-93
Change in Drag Area of Typical External Loads .....	T 7-1
Conditions .....	7-33
Description .....	7-31
Use of Charts .....	7-32
Dual Engine Failure .....	9-10
Dual Hook Fault Caution .....	4-46
E	
Electrical Power Panel .....	F 2-39
Electrical Power Supply System .....	2-146
AC System .....	2-147
DC System .....	2-151
ELECTRONIC SEQUENCING UNIT ...	2-156

<i>Subject</i>	<i>Paragraph Figure, Table Number</i>
EMER EXIT Switch .....	2-187
EMERG ENG TRIM Panel .....	2-43
Emergency Engine Trim Panel .....	2-17
EMERG UTIL PRESS Controllable Check Valve .....	2-104
EMERGENCY APU FLUID SHUT OFF VALVE .....	2-159
Emergency APU Fluid Shut Off Valve ...	F 2-42
Emergency Entrances and Exits .....	2-32
Emergency Equipment .....	F 9-1
Emergency Escape Axe .....	2-33
Emergency Troop Alarm and Jump Lights	2-29
First Aid Kits .....	2-31
Hand Fire Extinguishers .....	2-28
TROOP WARN Panel .....	2-30
Troop Warning Panel (Typical) .....	2-15
Emergency Exit Lighting .....	2-186
Emergency Exit Light .....	F 2-46
EMER EXIT Switch .....	2-187
Emergency Floodlights .....	2-183
Emergency Operation of Cargo Hooks .....	4-49
Emergency Power .....	5-11
Emergency Power System .....	2-44
EMERGENCY POWER Panel .....	2-45
Emergency Power Panel .....	F 2-18
Emergency Procedures .....	2-23
Helicopter Systems .....	9-1
After-Emergency Action .....	9-5
Definition of Emergency Terms .....	9-3
Emergency Entrance and Escape Routes	F 9-2
Emergency Equipment .....	F 9-1
Emergency Warning Signals and Exits ...	9-4
Immediate Action Emergency Checks ...	9-2
ENGINE .....	9-6
Autorotational Approach Corridor for Second Engine Failure .....	F 9-6
Dual Engine Failure .....	9-10
Engine Restart During Flight .....	9-13
Engine Shutdown - Complete Electrical Failure .....	9-17
Engine Shutdown - Condition Lever .....	9-18
Engine Shutdown with APU or APU Generator Inoperative .....	9-19
Engine Transmission Clutch Failure to Engage .....	9-16
Flight Characteristics .....	9-7
Height Velocity Diagram for Safe Landing After Single-Engine Failure .....	F 9-4
Maximum Glide Distance - Power Off .....	9-9
Maximum Glide Distance/Minimum Rate of Descent in Autorotation .....	F 9-5
Minimum Rate of Descent - Power off ...	9-8
NO.1 or NO.2 ENG OIL LOW or NO.1 or NO.2 ENG CHIP DET Caution .....	9-20
Normal Engine Beep Trim System Failure (High Side) or N2 Governor Failure ...	9-14
Normal Engine Beep Trim System Failure (Low Side or Static) .....	9-15

<i>Subject</i>	<i>Paragraph Figure, Table Number</i>	<i>Subject</i>	<i>Paragraph Figure, Table Number</i>
Single Engine Failure .....	9-11	Longitudinal Cyclic Trim (LCT) System	
Single Engine Failure - Low Altitude/Low		Failure .....	9-62
Airspeed and Cruise .....	9-12	Single AFCS Failure - Both Selected ...	9-63
Single-Engine Service Ceiling .....	F 9-3	Vertical Gyro Malfunction .....	9-65
ROTOR, TRANSMISSION, AND		ARMAMENT .....	9-68
DRIVE SYSTEMS .....	9-21	Armament Subsystems - M24 and M41 ..	9-69
NO.1 or NO. 2 ENG XMSN HOT Caution	9-22	CARGO .....	9-70
Transmission Debris Screen Latches ....	9-23	Jettisoning External Cargo .....	9 71
Transmission Low Oil Pressure or High		Hoist .....	9-72
Temperature Indications .....	9-24	Emergency Torque Available .....	7-10, F 7-2
XMSN AUX OIL PRESS Caution .....	9-27	Conditions .....	7-12
XMSN OIL HOT Caution .....	9-28	Use of Chart .....	7-11
XMSN OIL PRESS Caution .....	9-25	ENG COND Levers .....	2-41
XMSN OIL PRESS and XMSN AUX OIL		Engine Anti-Icing .....	2-37
PRESS or XMSN CHIP Caution .....	9-26	Engine Anti-Ice and Bypass Panel Removal	
FIRE .....	9-29	Requirement .....	T 5-1
Auxiliary Power Unit (APU) Fire .....	9-31	Engine Chip Detectors .....	2-57
Electrical Fire - Flight .....	9-34	Engine Chip Detector Fuzz Burn-Off .....	2-58
Engine Compartment, Fuselage or Electrical		Engine Compartment Fire Detection and	
Fire - Ground .....	9-33	Extinguishing System (Typical) .....	F 2-14
Engine Hot Start or Residual Fire		AGENT DISCH Switch .....	2-26
During Shutdown .....	9-30	Engine Compartment Fire Extinguisher	
Engine or Fuselage Fire - Flight .....	9-32	Pressures .....	T 2-1
Smoke and Fume Elimination .....	9-35	Engine Compartment Fire Extinguisher	
FUEL SYSTEM .....	9-36	System .....	2-24
Aux Fuel Pump Failure .....	9-37	FIRE DETR Switch .....	2-27
Fuel Low Caution .....	9-40	FIRE PULL Handles .....	2-25
FUEL LOW and FUEL PRESS Cautions	9-41	Engine Condition Panel .....	F 2-16
Fuel Venting .....	9-38	Engine Drain Valves .....	2-60
L or R FUEL PRESS Caution .....	9-39	Engine Fuel Control Units .....	2-39
ELECTRICAL SYSTEM .....	9-42	Engine Fuel Valves, Sta. 498 .....	F 2-21
BATT SYS MAL Caution .....	9-47	Engine Inlet Screens .....	2-36
NO. 1 and NO. 2 GEN OFF Cautions ...	9-44	Engine Instruments and Cautions .....	2-50
NO. 1 or NO. 2 GEN OFF Caution .....	9-43	Engine Chip Detectors .....	2-57
NO. 1 and NO. 2 RECT OFF Cautions ..	9-46	Engine Chip Detector Fuzz Burn-Off ....	2-58
NO. 1 or NO. 2 RECT OFF Caution .....	9-45	Engine Oil Level Caution .....	2-S6
HYDRAULIC SYSTEMS .....	9-48	Engine Oil Pressure Indicator .....	2-54
Hydraulic System .....	9-49	Engine Oil Temperature Indicator .....	2-55
NO. 1 and NO. 2 HYD FLT CONTR		Gas Producer Tachometer .....	2-51
Caution .....	9-51	Power Turbine Inlet Temperature Indicators	2-53
NO. 1 or NO. 2 HYD FLT CONTR		Torquemeter .....	2-52
Caution .....	9-50	Engine Interstage Air Bleed .....	2-59
UTIL HYD SYS Caution .....	9-52	Engine Limitations .....	5-12
Emergency Descent .....	9-53	Engine Oil System .....	2-224
Autorotative Landing .....	9-54	Engine Oil Level Caution .....	2-56
Ditching .....	9-58	Engine Oil Pressure Indicator .....	2-54
Ditching Exits .....	F 9-7	Engine Oil Temperature Indicator .....	2-55
Ditching - Power OFF .....	9-60	Engine Power Control System .....	2-38
Ditching - Power ON .....	9-59	Engine Rating and Power Level Limits ...	5-10
Emergency Entrance .....	9-57	Engine Restart During Flight .....	9-13
Emergency Entrance and Escape Routes	F 9-2	Engine Shutdown .....	8-42
Landing in Trees .....	9-56	Engine Start System .....	2-47
Landing With One Engine Inoperative ...	9-55	Engine Start Panel .....	F 2-19
FLIGHT CONTROLS .....	9-61	Ignition Lock Switch .....	2-49
Cockpit-Control Driver Actuator		START Panel .....	2-48
(CCDA) Failure .....	9-67	Engine Temperature Limitations .....	5-13
Differential Airspeed Hold Failure (DASH)	9-66	Engines .....	2-34
Dual AFCS Failure .....	9-64		

<i>Subject</i>	<i>Paragraph Figure, Table Number</i>	<i>Subject</i>	<i>Paragraph Figure, Table Number</i>
EMERG ENG TRIM Panel	2-43	Cyclic Stick	2-79
Emergency Engine Trim Panel	F 2-17	Cyclic Stick Grip	F 2-27
Engine Anti-Icing	2-37	Directional Pedals	2-82
ENG COND Levers	2-41	THRUST CONT Lever	2-78
Engine Condition Panel	F 2-16	Thrust Control Lever	F 2-26
Engine Drain Valves	2-60	Flight Controls Hydraulic Systems	
Engine Fuel Control Unit	2-39	Accumulators	2-230
Engine Interstage Air Bleed	2-59	Flight in Ice	5-36
Engine Power Control System	2-38	FLIGHT INSTRUMENTS	
Engine Rating and Power Level Limits	5-10	Airspeed Indicator	2-194
General	2-35	Altimeter	2-195
Oil Supply System	2 46	AIMS Altimeter	F 2-48
Normal Engine Beep Trim Switches	242	In Flight Operation - Altimeter	2-197
Speed Governing	2-40	Preflight Operation - Altimeter	2-196
ENVIRONMENTAL RESTRICTIONS		Attitude Indicator	2-202
Engine Anti-Ice and Bypass Panel Removal		CHRONOMETER	2-207
Requirement	T 5-1	Chronometer	F 2-50
Engine Inlet Screen Limitation	5-34	Normal Operation - CHRONOMETER	2-208
Flight in Ice	5-36	Setting ET	2-211
Flight Under Instrument Meteorological		Setting GMT	2-209
Conditions (IMC)	5-35	Setting LT	2-210
Operation With Skis	5-38	Test Mode	2-212
Thunderstorm Operation	5-37	Cruise Guide Indicator System	2-191
Equipment Loading and Unloading	6-50	CGI TEST Switch	2-193
Equivalent Oils and Hydraulic Fluids	T 24	CRUISE GUIDE Indicator	2-192
Extended Range Fuel System (ERFS) Weight		Cruise Guide Indicator	F 2-47
and Balance Data	6-85, T 6-3	Free Air Temperature Gauge	2-206
Extended Range Fuel System	4-56	General	2-190
ERFS Capabilities	4-57	Magnetic Compass	2-205
Exterior Lights	F 243	Master Caution System	2-213, F 2-51
External Cargo Airspeed Limits	5-23	CAUTION LT Panel	2-216
External Cargo Moments Chart	F 6-14	MASTER CAUTION Lights	2-215
External Power Caution	2-150	Master Caution Panel	2-214
External Power Receptacles	F 2-36	Master Caution Panel Capsules	T 2-2
	F	Pilot and Copilot Attitude Indicator	
FIRE DETR Switch	2-27	(VGI) Switch	2-203
FIRE PULL Handles	2-25	Radar Altimeter (AN/APN-209)	F 2-49
First Aid Kits	2-31	Radar Altimeter (AN/APN-209A)	2-198
Flare Dispenser M-130	4-8	Controls and Function, Radar Altimeter	
Controls and Function, Flare Dispenser		(AN/APN-209A)	2-199
System (M-130)	4-11	Normal Operation - Radar Altimeter	
Dispenser Control Panel	4-9	(AN/APN-209A)	2-200
Dispenser Status Panel	4-10	Turn and Slip Indicator (4-Minute Type)	2-204
Flare Dispenser System	F 4-7	VERTICAL SPEED Indicator	2-201
Normal Operation - M-130 Flare Dispenser	4-12	Flight Under Instrument Meteorological	
Preflight	4-13	Conditions (IMC)	5-35
In-Flight Operation	4-14	Floodlights	2-181
Before Landing Check	4-15	FLOOD Switches	2-182
After Landing Check	4-16	FORM Light Switches	2-163
FLIGHT CHARACTERISTICS		Formation Lights	2-162
AFCS Off Flight Characteristics	8-48	Forms and Records	1-10
GENERAL	8-47	Forward Transmission Oil Level Check	
Flight Control Limitations	5-32	Lights	2-188
Flight Control System	2-77	Forward and Aft Cargo Hooks	4-40, F 4-31
Advanced Flight Control System (AFCS)	2-83	Forward and Aft Cyclic Trim Indicators	F 2-29
AFCS Trim Switch	2-81	Free Air Temperature Gauge	2-206
CENTERING DEVICE RELEASE Switch	2-80	Fuel and Oil Data	6-6
		Fuel Moment Chart	F 6-2

<i>Subject</i>	<i>Paragraph, Figure, Table Number</i>
Fuel Weight and Moment .....	6-7
Oil Data .....	6-8
<b>FUEL CE LL SHUTOFF VALVE</b>	
TEST Switches .....	2-75
<b>FUEL FLOW</b>	
Conditions .....	7-39
Description .....	7-37
Idle Fuel Flow Chart.....	F 7-96
Single Engine Fuel Flow Chart .....	F 7-97
Use of Chart .....	7-38
Fuel Flow Indicators .....	2-69, F 2-24
Fuel Limitations .....	5-14
Fuel Moment Chart.....	F 6-2
Fuel Supply System.....	2-61
Controls and Indicators.....	2-63
Engine Fuel Valves, Sta .....	498 F 2-21
FUEL CONTR Panel .....	2-64
Fuel Control Panel.....	F 2-20
Fuel Flow Indicators.....	2-69, F 2-24
Fuel Quantity Indicator and Selector Switch 247, 2-74, F 2-23	
Fuel System Cautions.....	2-68
Fuel Tanks .....	2-62
Fuel Valves.....	2-65
Fuel Valve Warning Light, Sta .....	500 F 2-22
Manual Defueling Valve.....	2-66
Fuel Types .....	2-219
<b>G</b>	
Gas Producer Tachometer .....	2-51
General Arrangement .....	F 2-1
Generator Control Switches .....	2-148
Global Positioning System (GPS)	
AN/ASN-149(V) .....	3-65
Controls, Displays, and Function - Airborne Navigation Set .....	3-67
AN/ASN- 149(V) GPS Control and Display Unit (CDU) .....	F 3-17
GPS Data Loader Receptacle .....	3-66
Controls and Function - GPS Data Loader Receptacle .....	3-67
Normal Operation - GPS Data Loader Receptacle .....	3-68
Remote GPS Data Loader Receptacle/KYK-13 Fill Panel .....	F 3-18
GPS KYK- 13 Remote Fill Panel .....	3-69
Controls and Function - GPS KYK-13 Remote Fill Panel .....	3-70
Normal Operation - GPS KYK-13 Remote Fill Panel.....	3-71
Remote GPS Data Loader Receptacle/KYK- 13 Fill Panel .....	F 3-18

<i>Subject</i>	<i>Paragraph, Figure, Table Number</i>
GPS Zeroize Switch .....	3-72
Normal Operation - GPS Zeroize Switch .....	3-73
GND Switch .....	2-129
Gravity Refueling .....	2-223
Gross Weight .....	2-2
Ground Handling (Towing) .....	2-232
Ground Operation Limitations .....	5-33
Gyromagnetic Compass Set (AN/ASN-43) .....	3-30
Controls and Function..... Gyromagnetic Compass Set (AN/ASN-43) .....	3-31
Directional Gyro (CH-998/ASN-43) .....	F 3-12
Gyromagnetic Compass Set Control Panel ...	F 3-11
Operating Procedures - Gyromagnetic Compass Set .....	3-32
<b>H</b>	
Hand Fire Extinguishers.....	2-28
Hazardous Cargo .....	6-60
Heading Hold .....	2-85
Heading Select .....	2-88
Heads Up Display (AN/AVS-7) .....	4-161, F 4-71
Adjustment of Barometric Altitude, Pitch, and Roll .....	4-1612
CH-47D HUD Master Mode Display .....	F 4-72
CH-47D HUD Master Mode Symbology Display .....	F 4-73
Converter Control .....	4-162
Display Modes.....	4-166
Display Unit .....	4-164
Displayed System Faults .....	4-1611
In-flight Operation.....	4-1613
Modes of Operation.....	4-165
Operation HUD.....	4-167
Operator Self Test (BIT) .....	4-1610
Pilot/Copilot HUD Control (THRUST CONT Lever).....	4-163
Programming Procedure .....	4-169
Starting Procedure .....	4-168
Symbol Generator Test Mode .....	F 4-74
System Shutdown Procedure.....	4-1614
Heater Operation .....	8-57
Alternate Operation - Heating and Ventilating System .....	8-59
Normal Operation - Heating and Ventilating System .....	8-58
Heater Overheat Condition .....	8-61
Vibrator Contact Failure .....	8-60
Heating and Ventilating System .....	2-140
Air Control Handles .....	2-143
Cabin Heat Controls .....	2-144
Cockpit Air Knob.....	2-142
Heater Caution .....	2-145
HTG Panel .....	2-141, F 2-35



Subject	Paragraph, Figure, Table Number
Height Velocity Diagram for Safe Landing	
After Single-Engine Failure .....	F 94
Helicopter Compartment and Loading Diagram .....	6-2
Helicopter Internal Cargo Handling	
System (HICHS) .....	4-50
Fixture Configuration .....	F 4-33
Hatch Access .....	I 4-53
HICHS Cargo Types .....	I 4-51
HICHS with 463L Palletized .....	F 4-32
Internal Cargo Handling System .....	F 4-34
Load Configuration and Sequence .....	4-55
System Configurations .....	4-52
System Stowage .....	4-54
Tiedown Fittings HICHS .....	F 4-35
Helicopter Security (Typical) .....	2-236
Helicopter Description .....	1-2
HF Radio Set AN/ARC-HF-SSB 199) .....	3-15
Control/Display Panel, HF Radio Set (AN/ARC-HF-SSE1 199) .....	F 3-7
Display Fields, Controls and Function, HF Radio Set (AN/ARC- 199) .....	3-16
Operating Modes/Functions, HF Radio Set (AN/ARC-199) .....	3-17
HF Radio Set AN/ARC-220 .....	3-23.2
Control/Display Panel, HF Radio Set (AN/ARC-220) .....	F 3-7.1
Controls and Functions, HF Radio Set (AN/ARC-220) .....	3-23.3
Display Lines, HF Radio Set (AN/ARC-220) .....	3-23.1
Operating Modes/Functions HF Radio Set (AN/ARC-220) .....	3-23.5
High Density Loads .....	8-51
HICHS with 463L Palletized.....	F-4-32
Internal Cargo Handling System.....	F-4-34
Load Configuration and Sequence .....	4-55
System Configurations .....	4-52
System Stowage .....	4-54
Tiedown Fittings HICS .....	F4-35
Helicopter Security (Typical) .....	2-236
Helicopter	
Hoisting System .....	4-33, F 4-26
Auxiliary Control Panel (Station 95) .....	F 4-21
Hoist Control Panel .....	F 4-20
Hoist Control Valve and Hoist Control Shutoff Valve .....	F 4-27
Hoist Operators Panel (Station 320) .....	F 4-25
Overhead Cable Cutter Receptacle .....	F 4-23
Static Line Retriever .....	4-36
Static Line Retriever System .....	F 4-28
Which/Hoist Control Grip .....	F 4-24
Hook Loaded Advisory Lights .....	4-15

Subject	Paragraph, Figure, Table Number
Horizontal Situation Indicator (HSI) .....	3-55
Controls and Indicators - Horizontal Situation Indicators .....	3-56
Horizontal Situation Indicator Mode Select Panel .....	3-57
Horizontal Situation Indicator and Mode Select Panel .....	F 3-14
Hover Ceiling .....	F 7-7
Conditions .....	7-24
DESCRIPTION .....	7-22
Use of Chart .....	7-23
Hover Chart .....	F 7-6
Conditions .....	7-24
DESCRIPTION .....	7-22
Use of Chart .....	7-23
Hover .....	8-31
<b>HYDRAULIC SYSTEMS</b>	
BRK STEER Isolation Switch .....	2-101
EMERG UTIL PRESS Controllable Check Valve .....	2-104
Flight Control Systems .....	2-96
FIT CONTR Switch .....	2-97
Hydraulic Power Supply System .....	2-95
Hydraulic Pressure Cautions .....	2-105
Hydraulic Pressure Indicators .....	2-106
Hydraulics Control Panel .....	F 2-30
Hydraulic System Service Module .....	2-102
PWR XFER Switches .....	2-99
RAMP Isolation Switch .....	2-100
Utility Hydraulic System .....	2-98
Utility System Hand Pump .....	2-103
Hydraulic Systems Accumulator Precharge .....	2-229
Hydraulic Systems Fluid Servicing .....	2-228
Hydraulic Systems Servicing .....	2-227

I

<b>ICE AND RAIN</b> .....	8-85
Approach and Landing .....	8-91
Before Takeoff .....	8-89
During Flight .....	8-90
Exterior Inspection .....	8-87
Ice .....	8-86
Rain .....	8-92
Taxiing .....	8-88
Ignition Lock Switch .....	2-49
Indes .....	1-7
Installation of Helicopter Security	
Devices (Typical) .....	F 2-56
Instrument Flight Procedures .....	8-15
Instrument Flight - General .....	8-4
Instrument Glass Alignment .....	5-6

<i>Subject</i>	<i>Paragraph, Figure, Table Number</i>
Instrument Marking Color Codes.....	5-5
Instrument Markings .....	5-4F 5-1
Instrument and Control Panels .....	2-11
Canted Console (Typical) .....	F 2-7
Center Console (Typical).....	F 2-6
Center Instrument Panel (Typical) .....	F 2-9
Copilot Instrument Panel (Typical) .....	F 2-8
Overhead Switch Panel (Typical) (Interim NVG) .....	F 2-11
Overhead Switch Panel (Typical) (NVG) .....	F 2-12
Pilot Instrument Panel (Typical) .....	F 2-10
Internal Cargo Moments Chart.....	F 6-13
<b>INTRODUCTION</b>	
Aircraft Designation System .....	1-12
Army Aviation Safety Program .....	1-8
Change Symbol Explanation .....	1-11
Destruction of Army Material to Prevent Enemy Use.....	1-9
Forms and Records .....	1-10
General.....	1-1
Helicopter Description .....	1-2
Introductory Material.....	1-3
Index .....	1-7
Use of "Shall, Should and May" .....	1-13
Interphone System (C-533/ARC) .....	34
Controls and Function, Interphone Control (C-6533/ARC).....	3-5
Interphone Control (C-6533/ARC) .....	F 3-2
Interphone Stations .....	F 3-1
<b>J</b>	
JP-4 Equivalent Fuel .....	T 2-5
JP-5 and JP-8 Equivalent Fuel .....	T 2-6

<i>Subject</i>	<i>Paragraph, Figure, Table Number</i>
<b>L</b>	
LANDING .....	8-38
Landing From a Hover to Water .....	8-39
Landing Gear System .....	2-3
Landing Gear Proximity Switches .....	24
Steering and Swivel Lock System.....	2-5
Steering Control Panel.....	24, F 2-5
Landing Searchlights.....	2-166
Landing in Snow .....	8-48
<b>LIGHTING (NVG)</b>	
ANTI-COL Light Switches .....	2-165
Anticollision Lights.....	2-164
CABIN AND RAMP LIGHTS Switches .....	2-185
Cabin and Ramp Lights .....	2-184
Cabin Lighting and Controls .....	F 2-45
Canted and Center Console Lights .....	2-176
Cargo Hook Lighting .....	2-237
Center Instrument Panel Lights .....	2-174
CTR INST Switch .....	2-175
Dome Lights .....	2-178
DOME Switch.....	2-179
Emergency Exit Lighting .....	2-186
Emergency Exit Light .....	F 2-46
EMER EXIT Switch .....	2-187
Emergency Floodlights .....	2-183
Exterior Lights .....	F 243
Floodlights.....	2-181
FLOOD Switches .....	2-182
FORM Light Switches.....	2-163
Formation Lights .....	2-162
Forward Transmission Oil Level Check Lights .....	2-188
Landing Searchlights .....	2-166
LTG Panel .....	2-177
Oil Level Check Light Switch .....	2-189
Overhead Switch Panel Lights .....	2-170
OVHD CSL Switch .....	2-171
Pilot and Copilot Instrument Panel Lights .....	2-172

<i>Subject</i>	<i>Paragraph, Figure, Table Number</i>
Pilot and Copilot Utility Lights .....	2-180
PLT and CPLT INST Switches .....	2-173
Position Lights .....	2-160
Position Light Switches .....	2-161
SEARCH LIGHT Position Switch .....	2-169
SLT-FIL Switch .....	2-168
SRCHLT CONTR Switch .....	2-167
Litter Arrangement .....	6-17
Combination Seat and Litter Arrangement .....	6-21
Litter Installation .....	F 6-7
Litter Loading .....	6-20
Litter Patient Moments .....	F 6-4
Litter Poles and Straps .....	6-19
Litter Support Brackets .....	6-18
Seat and Litter Arrangement Data .....	T 6-1
Troop Seats and Litters .....	F 6-5
Load Clearances .....	F 6-24
Load Dumping From Ramp .....	6-84
Load Planning .....	6-64
Compartment Loading .....	6-65, F 6-20
Shoring .....	6-68
Station Loading .....	6-66, F 6-21
Stowage Locations .....	F 6-18
Vehicle Loading .....	6-67
<b>LOADING LIMITS</b>	
Cargo Hook Limitations .....	5-18
Center-of-Gravity Limitations .....	5-16
General .....	6-86
Maximum Gross Weight .....	5-17
Winch/ Rescue Hoist Limitations .....	5-19
Loading Sequence .....	6-78
Loading Sequence Configuration .....	T 6-4
Miscellaneous Cargo .....	6-82
Mixed Cargo .....	6-83
Personnel .....	6-81
Strength Areas .....	6-30
Warehouse Pallets .....	6-79
Wheeled Vehicles .....	6-80
Loading With Ramp Down (Forklift Loading) .....	F 6-22
Loading With Ramp In Level Position .....	F 6-23
Longitudinal Cyclic Trim System .....	2-89
Longitudinal Cyclic Trim (LCT) Actuator Airspeed Limits .....	5-26
Low Density Loads .....	8-50
LTG Panel .....	2-177

**M**

Machine Gun .....	4-18
Machine Gun Controls .....	4-20
Machine Gun M60D .....	F 4-9
Machine Gun Positioned on Pintle - Left Side Shown .....	F 4-16
Machine Gun Stowed on Right Mount .....	F 4-13

<i>Subject</i>	<i>Paragraph, Figure, Table Number</i>
Magnetic Compass .....	2-205
Main Cabin Door .....	2-13
MAINTENANCE PANEL .....	2-124, F 2-34
<b>MANEUVERING LIMITS</b>	
Aerobatics Prohibition .....	5-29
Bank Angle Limitations .....	F 5-7
Bank Limitations .....	5-30
Flight Control Limitations .....	5-32
Ground Operation Limitations .....	5-33
Landing Limitations .....	5-31, 5-44
Manual Defueling Valve .....	2-66
Manual Emergency Release Systems .....	4-42, 4-43
Map and Data Case .....	2-131
Marker Beacon Indicator .....	T 3-2
Master Caution System .....	2-213, F 2-51
CAUTION LT Panel .....	2-216
MASTER CAUTION Lights .....	2-215
Master Caution Panel .....	2-214
Master Caution Panel Capsules .....	T 2-2
Maximum Glide Distance - Power Off .....	9-9
Maximum Glide Distance/Minimum Rate of Descent in Autorotation .....	F 9-5
Maximum Gross Weight .....	5-17
Maximum Performance Takeoff .....	8-32
Maximum Torque Available (IO-Minute Operation) .....	7-13, F 7-3
Conditions .....	7-15
Use of Chart .....	7-14
Maximum Torque Available (30-Minute Operation) .....	7-16, F 7-4
Conditions .....	7-18
Use of Chart .....	7-17
Minimum Crew Requirement .....	5-3
Minimum Rate of Descent - Power Off .....	9-8
Mission Equipment Checks .....	8-7
Mission Equipment .....	6-23
Mission Equipment Weights and Moments .....	F 6-8
Mission Planning .....	8-1
Aviation Life Support Equipment (ALSE) .....	8-2
Crew Briefing .....	8-4
Crew Duties/Responsibilities .....	8-3
Passenger Briefing .....	8-5
Mooring .....	2-234
Mooring Data .....	T 2-7
Multi-Hook Loads .....	8-53

**N**

Night Flying .....	8-46
Normal Engine Beep Trim Switches .....	2-42
Normal Takeoff .....	8-30
No Step, No Handhold, and Walkway Areas .....	F 2-52

**O**

Oil Level Check Light Switch .....	2-189
------------------------------------	-------

<i>Subject</i>	<i>Paragraph, Figure, Table Number</i>	<i>Subject</i>	<i>Paragraph, Figure, Table Number</i>
Omega Navigation System (AN/ARN-118) .....	3-58	Use of Chart .....	7-23
AN/ARN-148 Omega Control Display Unit . .	F 3-15	Hover Ceiling .....	F 7-7
Controls and Function, Omega Control		Conditions .....	7-24
Unit. (fig. 3-15) .....	3-61	DESCRIPTION .....	7-22
Omega Control Display Unit .....	3-60	Use of Chart .....	7-23
Omega Navigation Principles .....	3-59	Takeoff Chart .....	F 7-8
<b>OPERATING LIMITS AND RESTRICTIONS</b>		Conditions .....	7-27
General .....	5-2	Description .....	7-25
Minimum Crew Requirement .....	5-3	Use of Chart .....	7-26
Purpose .....	5-1	Cruise Charts	
Operating Procedures And Maneuvers .....	8-6	Conditions .....	7-30
Checklist .....	8-9	Description .....	7-28
Mission Equipment Checks .....	8-7	Example Cruise Chart .....	F 7-9
Symbols Definitions .....	8-8	Use of Charts .....	7-29
Operation With Skis .....	5-38	98 and 100% Rotor RPM, -50°C.	
Operational PTIT Limits, T55-L-712 Engines ...	F 5-2	Sea Level .....	F 7-10
Overhead Cable Cutter Receptacle .....	F 4-23	98 and 100% Rotor RPM, -40°C.	
Overhead Switch Panel Lights .....	2-170	Sea Level .....	F 7-11
Overhead Switch Panel (Typical)		98 and 100% Rotor RPM, -30°C	
(Interim NVG) .....	F 2-11	Sea Level .....	F 7-12
Overhead Switch Panel (Typical) (NVG) .....	F 2-12	98 and 100% Rotor RPM, -20°C	
OVHD CSL Switch .....	2-171	Sea Level .....	F 7-13
		100% Rotor RPM, -10° and 0°C	
<b>P</b>		Sea Level .....	F 7-14
Parking .....	2-233	100% Rotor RPM, 10° and 20°C	
Parking Brake Handle .....	2-9	Sea Level .....	F 7-15
Passenger Briefing .....	8-5	100% Rotor RPM, 30° and 40°C,	
<b>PERFORMANCE DATA</b>		Sea Level .....	F 7-16
Data Basis .....	7-5	100% Rotor RPM, 50°C, Sea Level .....	F 7-17
Definitions of Abbreviations .....	7-9	98 and 100% Rotor RPM, -50°C,	
General Conditions .....	7-7	2,000 Feet .....	F 7-18
General Data .....	7-2	98 and 100% Rotor RPM, -40°C.	
Limits .....	7-3	2,000 Feet .....	F 7-19
Performance Discrepancies .....	7-8	98 and 100% Rotor RPM, -30°C,	
Purpose .....	7-1	2,000 Feet .....	F 7-20
Specific Conditions .....	7-6	98 and 100% Rotor RPM, -20°C,	
Use of Charts .....	7-4	2,000 Feet .....	F 7-21
Temperature Conversion Chart .....	F 7-1	100% Rotor RPM, -10° and 0°C,	
Emergency Torque Available .....	7-10, F 7-2	2,000 Feet .....	F 7-22
Conditions .....	7-12	100% Rotor RPM, 10° and 20°C,	
Use of Chart .....	7-11	2,000 Feet .....	F 7-23
Maximum Torque Available		100% Rotor RPM, 30° and 40°C,	
(10-Minute Operation) .....	7-13, F 7-3	2,000 Feet .....	F 7-24
Conditions .....	7-15	100% Rotor RPM, 50°C, 2,000 Feet .....	F 7-25
Use of Chart .....	7-14	98 and 100% Rotor RPM, -50°C	
Maximum Torque Available		4,000 Feet .....	F 7-26
(30-Minute Operation) .....	7-16, F 7-4	98 and 100% Rotor RPM, -40°C.	
Conditions .....	7-18	4,000 Feet .....	F 7-27
Use of Chart .....	7-17	98 and 100% Rotor RPM, -30°C	
Continuous Torque Available .....	7-19, F 7-5	4,000 Feet .....	F 7-28
Conditions .....	7-21	98 and 100% Rotor RPM, -20°C	
Use of Chart .....	7-20	4,000 Feet .....	F 7-29
Hover Chart .....	F 7-6	100% Rotor RPM, -10° and 0°C,	
Conditions .....	7-24	4,000 Feet .....	F 7-30
DESCRIPTION .....	7-22	100% Rotor RPM, 10° and 20°C,	
		4,000 Feet .....	F 7-31

<i>Subject</i>	<i>Paragraph, Figure, Table Number</i>
Checklist .....	8-9
Mission Equipment Checks .....	8-7
symbols Definitions .....	.
Operation With Skis .....	5-38
Operational PTTT Limits, T55-L-712 Engines .....	F 5-2
Overhead Cable Cutter Receptacle .....	F 4-23
Overhead Switch Panel Lights .....	2-170
Overhead Switch Panel (Typical) (Interim NVG) .....	F 2-11
Overhead Switch Panel (Typical) (NVG) .....	F 2-12
OVHD CSL Switch .....	2-171
P	
Parking .....	2-233
Parking Brake Handle .....	2-9
Passenger Briefing.....	8-5
<b>712</b> PERFORMANCE DATA	
Data Basis .....	7-5
Definitions of Abbreviations .....	7-9
General Conditions .....	7-7
General Data .....	7-2
Limits .....	7-3
Performance Discrepancies .....	7-8
Purpose .....	7-1
specific Conditions .....	7-6
Use of Charts .....	7-4
Temperature Conversion Chart .....	F 7-1
Emergency Torque Available .....	7-10, F 7-2
Conditions .....	7-12
Use of Chart .....	7-11

<i>Subject</i>	<i>Paragraph, Figure, Table Number</i>
Maximum Torque Available (10-Minute Operation) .....	7-13, F 7-3
Conditions .....	7-15
Use of Chart .....	7-14
Maximum Torque Available (30-Minute Operation) .....	7-16, F 7-4
Conditions .....	7-18
Use of Chart .....	7-17
Continuous Torque Available .....	7-19, F 7-5
Conditions .....	7-21
Use of Chart .....	7-20
Hover Chart .....	F7-6
Conditions .....	7-24
DESCRIPTION .....	7-22
Use of Chart .....	7-23
Hover Ceiling .....	F 7-7
Conditions .....	7-24
DESCRIPTION .....	7-22

<i>Subject</i>	<i>Paragraph, Figure, Table Number</i>	<i>Subject</i>	<i>Paragraph, Figure, Table Number</i>
Use of <b>Chart</b> .....	7-23	98 and 100% Rotor <b>RPM</b> , -50°C.	
Takeoff Chart .....	F 7-8	6,000 Feet .....	F 7-34
Conditions .....	<b>7-27</b>	98 and 100% Rotor RPM, -40°C,	
Description .....	<b>7-25</b>	6,000 Feet .....	F 7-35
use of Chart .....	<b>7-26</b>	98 and 100% Rotor RPM, -30°C,	
<b>Cruise Charts</b>		6,000 Feet .....	F 7-36
Conditions .....	7-3 0	98 and <b>100%</b> Rotor RPM, -20°C,	
Description .....	7-28	6,000 Feet .....	<b>F 7-37</b>
<b>Example Cruise Chart</b> .....	F 7-9	100% Rotor RPM, -10" and 0°C,	
Use of Charts .....	<b>7-29</b>	6,000 Feet .....	F 7-38
98 and 100% Rotor RPM, -50°C,		<b>100%</b> Rotor RPM, 10° and 20°C,	
<b>Sea Level</b> .....	<b>F 7-10</b>	6,000 Feet .....	F 7-39
98 and 100% Rotor RPM, -WC,		100% Rotor RPM, 30° and WC,	
Sea Level .....	<b>F 7-11</b>	6,000 Feet .....	<b>F 7-40</b>
98 and <b>100%</b> Rotor RPM, -3WC.		100% Rotor RPM, 50°C, 6,000 Feet .....	F 7-41
Sea Level .....	<b>F 7-12</b>	98 and 100% RPM, -50°C,	
98 <b>and</b> 100% Rotor RPM, -20°C,		8,000 Feet .....	F 7-42
<b>Sea Level</b> .....	<b>F 7-13</b>	98 and 100% Rotor RPM, -40°C,	
<b>100%</b> Rotor RPM, -10" and 0°C,		8,000 Feet .....	<b>F 7-43</b>
<b>Sea Level</b> .....	<b>F 7-14</b>	98 and 100% Rotor RPM, -30°C,	
100% Rotor RPM, 10° and 20°C,		8,000 Feet .....	F 7-44
<b>Sea Level</b> .....	<b>F 7-15</b>	98 and 100% Rotor RPM, -20°C,	
100% Rotor RPM, 30° and WC,		8,000 Feet .....	F 7-45
<b>Sea Level</b> .....	<b>F 7-16</b>	100% Rotor RPM, -10° and 0°C,	
<b>100%</b> Rotor RPM, 50°C, Sea Level .....	F 7-17	8,000 Feet .....	<b>F 7-46</b>
98 and <b>100%</b> Rotor RPM, -50°C.		100% Rotor RPM, 10° and 20°C,	
2,000 Feet .....	<b>F 7-18</b>	8,000 Feet .....	F 7-47
98 <b>and</b> 100% Rotor RPM, -40°C,		100% Rotor RPM, 30" and WC,	
2,000 Feet .....	<b>F 7-19</b>	8,000 Feet .....	F 7-48
98 <b>and</b> 100% Rotor RPM, -30°C,		100% Rotor RPM, 50°C, 8,000 Feet .....	F 7-49
2,000 Feet .....	<b>F 7-20</b>	98 and 100% Rotor <b>RPM</b> , -50°C,	
98 <b>and</b> 100% Rotor RPM, -20°C,		10,000 Feet .....	<b>F 7-50</b>
2,000 Feet .....	<b>F 7-21</b>	<b>98 and 100%</b> Rotor RPM, -40°C,	
100% Rotor RPM, -10° and 0°C,		10,000 Feet .....	<b>F 7-51</b>
2,000 Feet .....	<b>F 7-22</b>	98 and 100% Rotor RPM, -30°C.	
<b>100%</b> Rotor RPM, 10° and 20°C.		10,000 Feet .....	<b>F 7-52</b>
2,000 Feet .....	F 7-23	98 and 100% Rotor RPM, -20°C,	
100% Rotor RPM, 30° and 40°C,		10,000 Feet .....	<b>F 7-53</b>
2,000 Feet .....	<b>F 7-24</b>	100% Rotor RPM, -10° and 0°C,	
100% Rotor <b>RPM</b> , 50°C, 2,000 Feet .....	F 7-25	10,000 Feet .....	<b>F 7-54</b>
98 and 100% Rotor RPM, -50°C,		100% Rotor RPM, 10° and 20°C,	
4,000 Feet .....	<b>F 7-26</b>	10,000 Feet .....	F 7 5 5
98 and 100% Rotor RPM, -40°C,		100% Rotor RPM, 30" and WC,	
4,000 Feet .....	F 7-27	10,000 Feet .....	<b>F 7-56</b>
98 and 100% Rotor RPM, -30°C,		100% <b>Rotor</b> RPM, 50°C. 10,000 Feet .....	F 7-57
4,000 Feet .....	F 7-28	98 and 100% Rotor RPM, -50°C.	
98 and 100% Rotor RPM, -20°C.		12,000 Feet .....	<b>F 7-58</b>
4,000 Feet .....	<b>F 7-29</b>	98 and 100% Rotor RPM, -40°C,	
100% Rotor RPM, -10" and 0°C.		12,000 Feet .....	<b>F 7-59</b>
4,000 Feet .....	<b>F 7-30</b>	98 and 100% Rotor RPM, -30°C.	
100% Rotor RPM, 10° and 20°C,		12,000 Feet .....	<b>F 7-60</b>
4,000 Feet .....	<b>F 7-31</b>	98 and 100% Rotor RPM, -20°C.	
<b>100%</b> Rotor RPM, 30° and 40°C,		12,000 Feet .....	F 7-61
4,000 Feet .....	F 7-32	100% Rotor RPM, -10" and 0°C,	
<b>100%</b> Rotor RPM, 50°C, 4,000 Feet .....	F 7-33	12,000 Feet .....	F 7-62

<i>Subject</i>	<i>Paragraph, Figure, Table Number</i>
100% Rotor RPM, 10° and 20°C, 12,000 Feet .....	F 7-63
100% Rotor RPM, 30° and 40°C, 12,000 Feet ...	F 7-64
100% Rotor RPM, 50°C, 12,000 Feet . . . . .	F 7-65
98 and 100% Rotor RPM, -50°C, 14,000 Feet .....	F 7-66
98 and 100% Rotor RPM, -40°C, 14,000 Feet .....	F 7-67
98 and 100% Rotor RPM, -30°C, 14,000 Feet .....	F 7-68
98 and 100% Rotor RPM, -20°C, 14,000 Feet .....	F 7-69
100% Rotor RPM, -10° and 0°C, 14,000 Feet .....	F 7-70
100% Rotor RPM, 10° and 20°C, 14,000 Feet .....	F 7-71
100% Rotor RPM, 30° and 40°C, 14,000 Feet .....	F 7-72
100% Rotor RPM, 50°C, 14,000 Feet . . . . .	F 7-73
98 and 100% Rotor RPM, -50°C, 16,000 Feet .....	F 7-74
98 and 100% Rotor RPM, -40°C, 16,000 Feet .....	F 7-75
98 and 100% Rotor RPM, -30°C, 16,000 Feet .....	F 7-76
98 and 100% Rotor RPM, -20°C, 16,000 Feet . . . . .	F 7-77
100% Rotor RPM, -10° and 0°C, 16,000 Feet .....	F 7-78
100% Rotor RPM, 10° and 20°C, 16,000 Feet .....	F 7-79
100% Rotor RPM, 30° and 40°C, 16,000 Feet .....	F 7-80
98 and 100% Rotor RPM, -50°C, 18,000 Feet .....	F 7-81
98 and 100% Rotor RPM, -40°C, 18,000 Feet .....	F 7-82
98 and 100% Rotor RPM, -30°C, 18,000 Feet .....	F 7-83
98 and 100% Rotor RPM, -20°C, 18,000 Feet .....	F 7-84
100% Rotor RPM, -10° and 0°C, 18,000 Feet .....	F 7-85
100% Rotor RPM, 10° and 20°C, 18,000 Feet .....	F 7-86
98 and 100% Rotor RPM, -50°C, 20,000 Feet .....	F 7-87
98 and 100% Rotor RPM, -40°C, 20,000 Feet .....	F 7-88
98 and 100% Rotor RPM, -30°C, 20,000 Feet .....	F 7-89
98 and 100% Rotor RPM, -20°C, 20,000 Feet .....	F 7-90
100% Rotor RPM, -10° and 0°C, 20,000 Feet .....	F 7-91

<i>Subject</i>	<i>Paragraph, Figure, Table Number</i>
100% Rotor RPM, 10° and 20°C, 20,000 Feet .....	F 7-92
<b>Climb — Descent Chart</b> .....	F 7-94
Climb Performance .....	F 7-95
Conditions .....	7-36
Description .....	7-34
Use of Charts .....	7-35
<b>FUEL FLOW</b>	
Conditions .....	7-39
Description .....	7-37
Idle Fuel Flow <b>Chart</b> .....	F 7-96
Single Engine Fuel <b>Flow Chart</b> .....	F 7-97
Use of Chart .....	7-38
<b>714A PERFORMANCE DATA</b>	
Data Basis .....	7A-5
Definitions of Abbreviations .....	7A-9
General Conditions .....	7A-7
General Data .....	7A-2
Limits .....	7A-3
Performance Discrepancies .....	7A-8
<b>Purpose</b> .....	7A-1
Specific Conditions .....	7A-6
Use of Charts .....	7A-4
Temperature Conversion Chart .....	7A-1
Contingency Torque Available .....	7-10, F 7A-2
Conditions .....	7A-12
Use of Chart .....	7A-11
Maximum Torque Available (10-Minute Operation) .....	7A-13, F 7A-3
Conditions .....	7A-15
Use of Chart .....	7A-14
Intermediate Torque Available (30-Minute Operation) .....	7A-16, F 7A-4
Conditions .....	7A-18
Use of Chart .....	7A-17
Continuous Torque Available .....	7A-19, F 7A-5
Conditions .....	7A-21
Use of Chart .....	7A-20
Hover Chart .....	F 7A-6
Conditions .....	7A-24
<b>DESCRIPTION</b> .....	7A-22
Use of <b>Chart</b> .....	7A-23
Hover Ceiling .....	F 7A-7
Conditions .....	7A-24
<b>DESCRIPTION</b> .....	7A-22
Use of Chart .....	7A-23
Takeoff Chart .....	F 7A-8
Conditions .....	7A-27
Description .....	7A-25
Use of Chart .....	7A-26
<b>Cruise Charts</b>	
Conditions .....	7A-30
Description .....	7A-28
Example Cruise Chart .....	7A-9
Use of Charts .....	7A-29

<i>Subject</i>	<i>Paragraph, Figure, Table Number</i>
98 and 100% Rotor RPM, -50°C, <b>Sea Level</b> .....	F 7A-10
98 and 100% Rotor RPM, -40°C, <b>Sea Level</b> .....	7A-11
98 and 100% Rotor RPM, -30°C, <b>Sea Level</b> .....	7A-12
98 and 100% Rotor RPM, -20°C, <b>Sea Level</b> .....	F 7A-13
100% Rotor RPM, -10° and 0°C, <b>Sea Level</b> .....	7A-14
100% Rotor RPM, 10° and 20°C, <b>Sea Level</b> .....	7A-15
100% Rotor RPM, 30° and 40°C, <b>Sea Level</b> .....	F 7A-16
100% Rotor RPM, 50°C, <b>Sea Level</b> .....	F 7A-17
98 and 100% Rotor RPM, -SOT, <b>2,000 Feet</b> .....	7A-18
98 and 100% Rotor RPM, -40°C, <b>2,000 Feet</b> .....	7A-19
98 and 100% Rotor RPM, -30°C, <b>2,000 Feet</b> .....	F 7A-20
98 and 100% Rotor RPM, -20°C, <b>2,000 Feet</b> .....	F 7A-21
100% Rotor RPM, -10° and 0°C, <b>2,000 Feet</b> .....	F 7A-22
100% Rotor RPM, 10° and 20°C, <b>2,000 Feet</b> .....	F 7A-23
100% Rotor RPM, 30° and 40°C, <b>2,000 Feet</b> .....	F 7A-24
100% Rotor RPM, 50°C, <b>2,000 Feet</b> .....	F 7-25
98 and 100% Rotor RPM, -50°C, <b>4,000 Feet</b> .....	F 7A-26
98 and 100% Rotor RPM, -40°C, <b>4,000 Feet</b> .....	F 7A-27
98 and 100% Rotor RPM, -30°C, <b>4,000 Feet</b> .....	F 7A-28
98 and 100% Rotor RPM, -20°C, <b>4,000 Feet</b> .....	F 7A-29
100% Rotor RPM, -10° and 0°C, <b>4,000 Feet</b> .....	F 7A-30
100% Rotor RPM, 10° and 20°C, <b>4,000 Feet</b> .....	F 7A-31
100% Rotor RPM, 30° and 40°C, <b>4,000 Feet</b> .....	7A-32
100% Rotor RPM, 50°C, <b>4,000 Feet</b> .....	F 7A-33
98 and 100% Rotor RPM, -50°C, <b>6,000 Feet</b> .....	F 7A-34
98 and 100% Rotor RPM, -40°C, <b>6,000 Feet</b> .....	F 7A-35
98 and 100% Rotor RPM, -30°C, <b>6,000 Feet</b> .....	F 7A-36
98 and 100% Rotor RPM, -20°C, <b>6,000 Feet</b> .....	F 7A-37
100% Rotor RPM, -10° and 0°C, <b>6,000 Feet</b> .....	F 7A-38
100% Rotor RPM, 10° and 20°C, <b>6,000 Feet</b> .....	F 7A-39

<i>Subject</i>	<i>Paragraph, Figure, Table Number</i>
100% Rotor RPM, 30° and 40°C, <b>6,000 Feet</b> .....	F 7A-40
100% Rotor RPM, 50°C, <b>6,000 Feet</b> .....	F 7A-41
98 and 100% RPM, -50°C, <b>8,000 Feet</b> .....	F 7A-42
98 and 100% Rotor RPM, -40°C, <b>8,000 Feet</b> .....	7A-43
98 and 100% Rotor RPM, -30°C, <b>8,000 Feet</b> .....	7A-44
98 and 100% Rotor RPM, -20°C, <b>8,000 Feet</b> .....	7A-45
100% Rotor RPM, -10° and 0°C, <b>8,000 Feet</b> .....	7A-46
100% Rotor RPM, 10° and 20°C, <b>8,000 Feet</b> .....	F 7A-47
100% Rotor RPM, 30° and 40°C, <b>8,000 Feet</b> .....	F 7A-48
100% Rotor RPM, 50°C, <b>8,000 Feet</b> .....	F 7A-49
98 and 100% Rotor RPM, -50°C, <b>10,000 Feet</b> .....	F 7A-50
98 and 100% Rotor RPM, -40°C, <b>10,000 Feet</b> .....	7A-51
98 and 100% Rotor RPM, -30°C, <b>10,000 Feet</b> .....	F 7A-52
98 and 100% Rotor RPM, -20°C, <b>10,000 Feet</b> .....	7A-53
100% Rotor RPM, -10° and 0°C, <b>10,000 Feet</b> .....	F 7A-54
100% Rotor RPM, 10° and 20°C, <b>10,000 Feet</b> .....	F 7A-55
100% Rotor RPM, 30° and 40°C, <b>10,000 Feet</b> .....	F 7A-56
100% Rotor RPM, 50°C, <b>10,000 Feet</b> .....	F 7A-57
98 and 100% Rotor RPM, -50°C, <b>12,000 Feet</b> .....	F 7A-58
98 and 100% Rotor RPM, -40°C, <b>12,000 Feet</b> .....	F 7A-59
98 and 100% Rotor RPM, -30°C, <b>12,000 Feet</b> .....	F 7A-60
98 and 100% Rotor RPM, -20°C, <b>12,000 Feet</b> .....	7A-61
100% Rotor RPM, -10° and 0°C, <b>12,000 Feet</b> .....	7A-62
100% Rotor RPM, 10° and 20°C, <b>12,000 Feet</b> .....	F 7A-63
100% Rotor RPM, 30° and 40°C, <b>12,000 Feet</b> .....	F 7A-64
100% Rotor RPM, 50°C, <b>12,000 Feet</b> .....	F 7A-65
98 and 100% Rotor RPM, -50°C, <b>14,000 Feet</b> .....	F 7A-66
98 and 100% Rotor RPM, -40°C, <b>14,000 Feet</b> .....	F 7A-67
98 and 100% Rotor RPM, -30°C, <b>14,000 Feet</b> .....	F 7A-68
98 and 100% Rotor RPM, -20°C, <b>14,000 Feet</b> .....	F 7A-69



<i>Subject</i>	<i>Paragraph, Figure, Table Number</i>	<i>Subject</i>	<i>Paragraph, Figure, Table Number</i>
100% Rotor RPM, -10° and 0°C, 14,000 Feet .....	F 7A-70	AIRSPPEED CALIBRATION	
100% Rotor RPM, 10° and 20°C, 14,000 Feet .....	F 7A-71	Conditions .....	7A-42
100% Rotor RPM, 30° and 40°C, 14,000 Feet .....	F 7A-72	Description .....	7A-40
100% Rotor RPM, 50°C, 14,000 Feet .....	F 7A-73	Airspeed Calibration Chart .....	F 7A-98
98 and 100% Rotor RPM, -50°C, 16,000 Feet .....	F 7A-74	Use of Chart .....	7A-41
98 and 100% Rotor RPM, -40°C, 16,000 Feet .....	F 7A-75	Personnel <b>Loading</b> and Unloading .....	6-9
98 and 100% Rotor RPM, -30°C, 16,000 Feet .....	F 7A-76	Personnel Moments .....	F 6-3
98 and 100% Rotor RPM, -20°C, 16,000 Feet .....	F 7A-77	Personnel Weight Computation .....	6-10
100% Rotor RPM, -10° and 0°C, 16,000 Feet .....	F 7A-78	Seat and Litter Arrangement Data .....	T 6-1
100% Rotor RPM, 10° and 20°C, 16,000 Feet .....	F 7A-79	Seating Arrangement .....	6-11
100% Rotor RPM, 30° and 40°C, 16,000 Feet .....	F 7A-80	Troop Commander's Jump Seat .....	6-16
98 and 100% Rotor RPM, -50°C, 18,000 Feet .....	F 7A-81	Troop Loading .....	6-15
98 and 100% Rotor RPM, -40°C, 18,000 Feet .....	F 7A-82	Troop Seats .....	6-12
98 and 100% Rotor RPM, -30°C, 18,000 Feet .....	F 7A-83	Troop Seat Installation .....	6-13, F 6-6
98 and 100% Rotor RPM, -20°C, 18,000 Feet .....	F 7A-84	Troop Seats and Litters .....	F 6-5
100% Rotor RPM, -10° and 0°C, 18,000 Feet .....	F 7A-85	<b>Troop Seat Stowage</b> .....	6-1 4
100% Rotor RPM, 10° and 20°C, 18,000 Feet .....	F 7A-86	<b>Personnel/Cargo Doors</b> .....	2-1 2
98 and 100% Rotor RPM, -50°C, 20,000 Feet .....	F 7A-87	<b>Cargo Door and Ramp</b> .....	2-14, 6-45, F 6-15
98 and 100% Rotor RPM, -40°C, 20,000 Feet .....	F 7A-88	Main Cabin Door .....	2-13
98 and 100% Rotor RPM, -30°C, 20,000 Feet .....	F 7A-89	Main Cabin Entrance .....	6-26
98 and 100% Rotor RPM, -20°C, 20,000 Feet .....	F 7A-90	Pilot and Copilot Sliding <b>Windows</b> .....	2-15
100% Rotor RPM, -10° and 0°C, 20,000 Feet .....	F 7A-91	Pilot Assist Straps .....	2-139
100% Rotor RPM, 10° and 20°C, 20,000 Feet .....	F 7A-92	Pilot Instrument Panel (Typical) <b>712</b> .....	F 2-10
<b>Climb — Descent Chart</b> .....	F 7A-94	Pilot Instrument Panel (Typical) <b>714A</b> .....	F 2-12.3
Climb Performance .....	F IA-95	Pilot and Copilot Instrument Panel <b>Lights</b> .....	2-172
Conditions .....	7A-36	Pilot and Copilot Sliding Windows .....	2-15
Description .....	7A-34	Pilot and Copilot Utility Lights .....	2-180
Use of Charts .....	7A-35	PLT and CPLT INST Switches .....	2-173
<b>FUEL FLOW</b>		Position Lights .....	2-160
Conditions .....	7A-39	POSN Light Switch .....	2-161
Description .....	7A-37	Power Distribution <b>Panels</b> (Typical) <b>712</b> .....	F 2-37
Idle Fuel Flow Chart .....	F 7A-96	Power Distribution Panels (Typical) <b>714A</b> .....	F 2-40.1
Single Engine Fuel Flow Chart .....	F 7A-97	<b>POWER LIMITS</b>	
Use of Chart .....	7A-38	<b>712</b> Emergency Power .....	5-11
		<b>714A</b> Contingency Power .....	S-11.1
		<b>Engine Rating and Power Level Limits</b> .....	5-10
		<b>712</b> Engine Limitations .....	5-12
		<b>714A</b> Engine Limitations .....	S-12.1
		<b>712</b> Engine Temperature <b>Limitations</b> .....	5-13
		<b>714A</b> Engine Temperature (PTIT) Limitations .....	S-13. 1
		Fuel Limitations .....	5-14
		<b>712</b> Operational PTIT Limits .....	F S-2
		Transmission Torque Limitations (Steady-State) .....	5-15
		<b>POWER TRAIN SYSTEM</b>	
		<b>General</b> .....	2-107
		Transmission Lubrication Systems .....	2-108
		Power Turbine Inlet Temperature Indicators .....	2-53
		Preflight Check .....	8-10
		Before Exterior Check .....	8-11
		<b>EXTERIOR CHECK</b> .....	8-15
		Aft Cabin .....	8-16
		<b>Forward Cabin</b> .....	8-18
		Left Cabin .....	8-19

<i>Subject</i>	<i>Paragraph, Figure, Table Number</i>
Right Cabin .....	8-17
Top of Fuselage .....	8-20
Walk Around Check and Security Brief .....	8-21
<b>INTERIOR CHECK</b> .....	8-12
Aft Cabin .....	8-14
Forward Cabin .....	8-13
Before Starting Engines .....	8-22
Starting Engines .....	8-23
Engine Ground Operation .....	8-24
Before Taxi .....	8-25
Taxiing .....	8-26
Before Hover .....	8-27
Hover Check .....	8-28
Before Takeoff .....	8-29
Preparation of General Cargo .....	6-55
Cargo Center of Gravity .....	6-58
Cargo Dimensions .....	6-56
Cargo Weight .....	6-57
Hazardous Cargo .....	6-60
Vehicle Load .....	6-59
Pressure Actuated Valve .....	6-48
Pressure Refueling System .....	2-70
Controls and Indicators .....	2-71
<b>FUEL CELL SHUTOFF VALVE</b> <b>TEST Switches</b> .....	2-75
<b>Fuel Quantity Indicator and Selector</b> <b>Switch</b> .....	2-74
<b>Pressure Refueling Station</b> .....	F 2-25
<b>PWR Control Switch</b> .....	2-72
<b>Refueling Station switch</b> .....	2-73
<b>REFUEL VALVE POSN Indicating Lights</b> .....	2-76
<b>Principal Dimensions Diagram</b> .....	F 2-2
<b>Protective Covers</b> .....	2-235, F 2-55
<b>PWR XFER Switches</b> .....	2-99
<b>R</b>	
<b>RAMP Isolation Switch</b> .....	2-100
<b>Radar Altimeter (AN/APN-209A)</b> .....	2-198
<b>Radar Altimeter (AN/APN-209)</b> .....	F 2-49
<b>Radar Altimeter (AN/APN-209( )) Altitude Voice</b> <b>Warning System (AVWS)</b> .....	2-200.1
<b>Controls and Function, Radar Altimeter</b> <b>(AN/APN-209( )) (AVWS)</b> .....	2-200.2
<b>Mod Operation - Radar Altimeter</b> <b>(AN/APN-209( )) (AVWS)</b> .....	2-200.3
<b>Radar Signal Detecting Set Control</b> .....	F 4-1
<b>Radar Signal Detecting Set Indicator</b> .....	F 4-2
<b>Radar Signal Detecting Set</b> <b>(OFF and EID VERSION DISPLAY)</b> .....	F 4-3
<b>Radar Signal Detecting Set Indicator</b> <b>Self Test Displays</b> .....	F 4-4
Deleted .....	F 4-5
Rain .....	8-92
<b>RAMP EMER Control Switch</b> .....	2-101.1
<b>Ramp Operation</b> .....	6-51
<b>Emergency In-Flight Operation</b> .....	6-53.1

<i>Subject</i>	<i>Paragraph, Figure, Table Number</i>
<b>In-Flight Operation</b> .....	6-53
<b>Manual Operation - Cargo Door</b> .....	6-54
<b>Normal Operation</b> .....	6-52
<b>Pressure Actuated Valve</b> .....	6-48
<b>Ramp Controls</b> .....	F 6-16
<b>Ramp Control Sequence Valve</b> .....	6-47
<b>Ramp Control Valve</b> .....	6-46
<b>RAMP PWR Switch</b> .....	2-100
<b>REFUEL VALVE POSN Indicating Lights</b> .....	2-76
<b>Refueling Station Switch</b> .....	2-73
<b>Restraint</b> .....	6-63
<b>Restraint Criteria</b> .....	6-70
<b>Restraint Devices</b> .....	6-71
<b>Reversionary System</b> .....	2-60.2
<b>714A REV 1 and /or REV 2 (WITH)</b> <b>FADEC LIGHT ON</b> .....	9-15.5
<b>714A REV 1 and /or REV 2 (WITHOUT)</b> <b>FADEC LIGHT ON</b> .....	9-15.6
<b>ROTOR SYSTEM</b>	
<b>General</b> .....	2-119
<b>Rotor Blades</b> .....	2-120
<b>Rotor Blade Start-Up &amp; Shut Down Liits</b> .....	F5-7.1
<b>Rotor Tachometers</b> .....	2-121
<b>Running Landing to Water</b> .....	8.40

**S**

<b>SALT WATER OPERATION</b> .....	8-93
<b>After Flight</b> .....	8-96
<b>Hovering</b> .....	8-95
<b>Power Deterioration</b> .....	8-94
<b>SEARCH LIGHT Position Switch</b> .....	2-169
<b>Sea State Limits</b> .....	5-41
<b>Seats</b> .....	2-16
<b>Armored Seats</b> .....	2-20, F 2-13
<b>Seat Fore-and-Aft Lever</b> .....	2-17
<b>Seat Rotation Lever</b> .....	2-19
<b>Seat Vertical Lever</b> .....	2-18
<b>Shoulder Harness Inertia Reel Lock Lever</b> .....	2-21
<b>Seat and Litter Arrangement Data</b> .....	T 6-1
<b>seating Arrangement</b> .....	6-11
<b>Securing Cargo</b> .....	6-69
<b>Calculation of Tiedown Devices Required</b> .....	6-72
<b>Restraint Criteria</b> .....	6.70
<b>Restraint Devices</b> .....	6-71
<b>Self-Tuning Dynamic Absorbers</b> .....	2-22
<b>Sequence valve Operation</b> .....	F 6-17
<b>Series and Effectivity Codes</b> .....	I-12.1
<b>SERVICING, PARKING; AND MOORING</b>	
<b>General</b> .....	2-217
<b>Ground Handling (Towing)</b> .....	2-232
<b>Mooring</b> .....	2-234
<b>Mooring Data</b> .....	T 2-7
<b>Parking</b> .....	2-233
<b>Helicopter Security (Typical)</b> .....	2-236

<i>Subject</i>	<i>Paragraph, Figure, Table Number</i>
Installation of Helicopter <b>Security</b>	
Devices <b>(Typical)</b> .....	F 2-56
Protective Covers .....	2-235, F 2-55
Servicing .....	2-218, T 2-3
<b>Accumulators Precharge Limits</b> .....	F 2-54
APV Oil System .....	2-225
Equivalent Oils and Hydraulic Fluids .....	T 2-4
Fuel <b>Tanks</b> Servicing .....	2-221
Gravity Refueling .....	2-223
Hydraulic Systems <b>Accumulator Precharge</b> .....	2-229
Hydraulic Systems Fluid Servicing .....	2-228
Hydraulic Systems <b>Servicing</b> .....	2-221
IF-4 <b>Equivalent</b> Fuel .....	T 2-5
<b>JP-5</b> and <b>JP-8</b> Equivalent Fuel .....	T 2-6
No Step, No <b>Handhold</b> , and Walkway	
Areas .....	F 2-52
Servicing <b>Diagram</b> .....	F 2-53
Single-Point <b>Pressure</b> Refueling .....	2-222
<b>Transmission</b> Oil System .....	2-226
Use of Fuels .....	2-220
Utility System Accumulators .....	2-231
Shoulder <b>Harness</b> Inertia Reel Lock <b>Lever</b> .....	2-21
Single Engine <b>Failure</b> .....	9-1 1
Single Engine Failure — <b>Low Altitude/Low</b>	
<b>Airspeed</b> and Cruise .....	9-12
<b>712</b> <b>Single-Engine</b> Service <b>Ceiling</b> .....	F 9-3
<b>714A</b> <b>Single-Engine</b> Service <b>Ceiling</b> .....	F 9-4.1
<b>Slingload</b> .....	8-33
SLT-FIL Switch .....	2-168
Spare Lamp Stowage <b>Box</b> .....	2-133
Speed <b>Governing</b> .....	2-40
<b>SRCHLT</b> <b>CONTR</b> Switch .....	2-167 S
<b>Starting</b> in <b>Primary Mode</b> <b>714A</b> .....	2-6a.1
Static Line Anchor Cable .....	6-22
Static Line <b>Retriever</b> System .....	F 4-28
Static Line <b>Retriever</b> .....	4-36
<b>Steering</b> and Swivel <b>Lock</b> System .....	2-5
Steering Control Panel .....	2-6, F 2-5
<b>SYSTEM LIMITS</b>	
Inoperative Cruise Guide Indicator .....	5-8
Instrument Glass Alimnt .....	5-6
Instrument <b>Marking</b> Color Codes .....	5-5
<b>Instrument</b> Markings .....	5-4, F 5-1
Rotor <b>Limitations</b> .....	5-7
Starting and <b>Shutdown</b> Limits .....	5-9
T	
Takeoff <b>Chart</b> .....	F 7-8
Conditions .....	7-27
Description .....	1-25
Use of <b>Chart</b> .....	1-26
<b>Taxi Director</b> and Blade <b>Watcher</b> Positions .....	F 8-1
<b>THRUST</b> <b>CONT</b> Lever .....	2-78
Thrust Control <b>Lever</b> .....	F 2-26

<i>Subject</i>	<i>Paragraph, Figure, Table Number</i>
<b>Thunderstorm</b> Operation .....	5-37
<b>Tiedown Fittings</b> .....	6-38, F 6-11
Five Thousand-Pound-Capacity <b>Tiedown</b>	
Fittings .....	6-39
<b>Ten Thousand-Pound-Capacity</b>	
<b>Tiedown</b> Fittings .....	6-40
<b>Tiedown Methods</b> .....	6-73
Bulk <b>Cargo Tiedown</b> .....	6-75
<b>General Cargo Tiedown</b> .....	6-76
<b>Vehicle Tiedown</b> .....	6-74
463 L <b>Pallet/</b> Extended Range Fuel	
<b>System (ERFS)</b> .....	6-77
<b>714A</b> <b>Torque Measuring</b> System Malfunctions ...	9-15.7
<b>Torquemeter</b> .....	2-52
<b>Transformer</b> Rectifier Cautions .....	2-153
<b>Transmission</b> Lubrication Systems .....	2-108
Aft <b>Transmission</b> .....	2-110
<b>Combining</b> and <b>Engine</b> <b>Transmission</b>	
Lubrication Systems .....	2-111
Forward <b>Transmission</b> .....	2-109
<b>Transmission</b> Chip <b>Detectors</b> .....	2-117
<b>Transmission</b> Chip <b>Detectors</b> Fuzz Bum-Off ...	2-1 18
<b>Transmission</b> <b>Main</b> Oil Pressure Indicator	
and Selector Switch .....	F 2-3 1
<b>Transmission</b> <b>Main</b> Oil <b>Pressure</b> Indicator .....	2-112
<b>Transmission</b> <b>Main</b> Oil Pressure	
Selector Switch .....	2-113
<b>Transmission</b> <b>Main</b> Oil <b>Temperature</b>	
Indicator .....	2-114
<b>Transmission</b> <b>Main</b> Oil <b>Temperature</b>	
Selector Switch .....	2-115
<b>Transmission</b> <b>Main</b> Oil <b>Temperature</b> Switch	
and Indicator .....	F 2-32
<b>Transmission</b> Oil Cautions .....	2-116
<b>Transmission</b> <b>Torque</b> Limitations	
(Steady-State) .....	5-15
<b>Transponder</b> System ( <b>AN/APX-100</b> ) .....	3-62
<b>AN/APX-100</b> Control Panel .....	F 3-16
Controls and Function. <b>Transponder</b> Control	
( <b>RT-1285/APX-100</b> )( <b>RT-1558/APX-100</b> ) .....	3-53
<b>Normal</b> Operation- <b>Transponder</b> System .....	3-64
<b>Triple</b> <b>Cargo</b> Hook System .....	4-37
Center <b>Cargo</b> <b>Hook</b> .....	4-38
Center <b>Cargo</b> <b>Hook</b> and <b>Cargo</b> <b>Hook</b>	
<b>Release</b> .....	F 4-30
Center <b>Cargo</b> <b>Hook</b> <b>Loading</b> Pole	
(Typical) .....	F 4-29
Center <b>Cargo</b> <b>Hook</b> <b>Loading</b> Pole .....	4-39
<b>Cargo</b> <b>Hook</b> <b>Cautions</b> .....	4-44
<b>Cargo</b> <b>Hook</b> Controls .....	4-41
<b>Cargo</b> <b>Hooks</b> Operational Check .....	4-47
Dual <b>Hook</b> Fault Caution .....	4-46
Emergency <b>Operation</b> of <b>Cargo</b> <b>Hooks</b> .....	4-49
Forward and Aft <b>Cargo</b> <b>Hooks</b> .....	4-40, F 4-31
<b>Hook</b> <b>Loaded</b> Advisory Lights .....	4-45

<i>Subject</i>	<i>Paragraph, Figure, Table Number</i>
<b>Manual</b> Emergency <b>Release Systems</b> .....	4-42, 4-43
Normal operation of Cargo Hooks .....	4-48
<b>Troop Commander's Jump Seat</b> .....	6-16
<b>Troop Loading</b> .....	6-15
<b>Troop Seats</b> .....	6-12
Troop Seat Installation .....	6-13, F 6-6
Troop Seats and Litters .....	F 6-5
Troop Seat Stowage .....	6-14
<b>TROOP WARN Panel</b> .....	2-30
Troop <b>Warning Panel (Typical)</b> .....	F 2-15
<b>TURBULENCE AND THUNDERSTORM OPERATION</b> .....	8-81
Flight in <b>Thunderstorms</b> .....	8-84
In <b>Turbulent Air</b> .....	8-83
<b>Prior to Entering Turbulent Air</b> .....	8-82
<b>Turn and Slip Indicator (4-Minute Type)</b> .....	2-204
<b>Turning Radii</b> .....	F 2-3

**U**

<b>UHF-AM Have Quick II Radio</b> (AN/ARC-164) .....	3-7, F 3-4, T 3-1.1
<b>Controls and Function, UHF-AM Have Quick II Radio</b> (AN/ARC-164) .....	3-8
<b>Normal Operation — UHF-AM Radio</b> .....	3-9
Use of Airspeed Limitations Chart .....	5-27
<b>Use of Fuels</b> .....	2-220
Use of “ <b>Shall, Should, and May</b> ” .....	1-13
Utility System Accumulators .....	2-231
Utility System Hand <b>Pump</b> .....	2-103
<b>UTILITY SYSTEMS</b>	
AC Cabin Utility Receptacles .....	2-135
<b>ANTI ICE Panel</b> .....	2-123
Anti Ice <b>Panel</b> .....	F 2-33
Anti-Icing Systems .....	2-122
Ash <b>Trays</b> .....	2-137
Cockpit Rearview <b>Mirror</b> .....	2-132
Cockpit Utility Receptacles .....	2-134
Compass Correction Card Holder .....	2-138
IX Cabin Utility Receptacles .....	2-136
<b>MAINTENANCE PANEL</b> .....	2-124, F 2-34
ENGINE CHIP DETECTOR Section .....	2-127
GROUND CONTACT Section .....	2-128
HYDRAULICS Section .....	2-126
TRANSMISSION Section .....	2-125
Map and Data Case .....	2-131
Pilot Assist Straps .....	2-139
Spare Lamp Stowage <b>Box</b> .....	2-133
Windshield <b>Wipers</b> .....	2-130

**V**

Vehicle <b>Tiedown</b> .....	6-74
<b>VERTICAL SPEED Indicator</b> .....	2-201
<b>VHF AM/FM Radio Sets (AN/ARC-186)</b> ....	3-10, F 3-5
Controls and Function, VHF <b>AM/FM</b> Radio Set .....	3-1 1

<i>Subject</i>	<i>Paragraph, Figure, Table Number</i>
<b>Normal Operation — AM/FM Radio Set</b> .....	3-12
<b>VHF NAVIGATION AND INSTRUMENT LANDING SYSTEM (AN/ARN-123)</b> .....	3-24
Controls and <b>Function, VHF Navigation and</b> Instrument <b>Landing System Set</b> .....	3-25
Marker Beacon Indicator .....	T 3-2
Normal operation — <b>VHF Navigation and</b> <b>Instrument Landing System</b> .....	3-26
VHF Navigation and <b>Instrument Landing</b> System <b>Control (AN/ARN-123)</b> .....	F 3-9
<b>VHF/FM Radio Set (AN/ARC-201)</b> .....	3-13, F 3-6
Controls and Functions <b>VHF/FM Radio Set</b> .....	3-14
Voice Security <b>Equipment TSEC/KY-58</b> .....	3-18
<b>Controls and Function</b> .....	3-19
<b>Normal Operation</b> .....	3-20
Remote Control Unit <b>TSEC/KY-58</b> ( <b>Z-AHP</b> ) .....	F 3-8
Voice Security Equipment <b>TSEC/KY-75</b> .....	3-21
<b>Controls and Function, Voice Security</b> Equipment ( <b>TSEC/KY-75</b> ) .....	3-22
Normal Operations, Voice Security Equipment ( <b>TSEC/KY-75</b> ) .....	3-23

**W**

Warehouse Pallets .....	6-79
<b>WATER OPERATION LIMITATIONS</b> .....	5-39
Description of Sea States .....	T 5-2
<b>Gross Weight Limitations</b> .....	5-43
<b>Landing Limitations</b> .....	5-45
Night operation on Water .....	5-40
operation <b>Time Limit</b> .....	5-42
Rotor Starting and <b>Shutdown Limitations</b> .....	5-46
sea state <b>Limits</b> .....	5-41
Taxiing Limitations .....	5-44
Water <b>Landing Speed Limitations Up To</b> 46,000 Pounds <b>Gross Weight</b> .....	F 5-8
<b>WEIGHT/BALANCE AND LOADING</b>	
Aircraft <b>Compartment and Loading</b> Diagram .....	F 6-1
Classification of Helicopter .....	.6-3
DD Form 365-3 <b>Chart C -Basic Weight</b> and Balance Record .....	.6-4
DD Form 3654 (Weight and Balance Clearance <b>Form F</b> ) .....	.6-5
Helicopter <b>Compartment and Loading</b> Diagram .....	.6-2
<b>Purpose</b> .....	.6-1
Winch .....	4-31, 6-44
Static Line Retriever System .....	F 4-28
Static <b>Line Retriever</b> .....	4-36
Winching <b>Accessories</b> .....	4-34
Winch Capabilities .....	F 4-19
<b>Winch Controls</b> .....	4-32
<b>Winch/Hoist Control Grip</b> .....	F 4-24
<b>Winch operation</b> .....	4-33

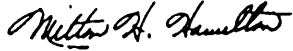
<b>Subject</b>	<b>Paragraph, Figure, Table Number</b>
<b>Winching</b> Receptacle (Station 502) .....	F 4-22
<b>Winching System</b> .....	F 4-18
<b>Winch/ Rescue Hoist Limitations</b> .....	5-19
<b>Windshield Wipers</b> .....	2-130

<b>Subject</b>	<b>Paragraph, Figure, Table Number</b>
<b>XMSN</b> AUX OIL PRESS Caution .....	9-27
XMSN OIL HOT Caution .....	9-28
XMSN OIL PRESS Caution .....	9-25
<b>XMSN</b> OIL PRESS <b>and</b> XMSN AUX OIL PRESS or XMSN <b>CHIP</b> Caution .....	9-26

X

By Order of the Secretary of the Army:

Official:



MILTON H. HAMILTON  
*Administrative Assistant to the  
Secretary of the Army*

01620

GORDON R. SULLIVAN  
*General, United States Army  
Chief of Staff*

**DISTRIBUTION:**

To be distributed in accordance with DA Form 12-31-E, block no. 1218, -10 & CL maintenance requirements for TM 55-1520-240-10.

## ***These are the instructions for sending an electronic 2028***

The following format must be used if submitting an electronic 2028. The subject line must be exactly the same and all fields must be included; however, only the following fields are mandatory: 1, 3, 4, 5, 6, 7, 8, 9, 10, 13, 15, 16, 17, and 27.

From: "Whoever" [whoever@avma27.army.mil](mailto:whoever@avma27.army.mil)  
To: [2028@redstone.army.mil](mailto:2028@redstone.army.mil)  
Subject DA Form 2028

1. **From:** Joe Smith
2. **Unit:** home
3. **Address:** 4300 Park
4. **City:** Hometown
5. **St:** MO
6. **Zip:** 77777
7. **Date Sent:** 19-OCT-93
8. **Pub no:** 55-2840-229-23
9. **Pub Title:** TM
10. **Publication Date:** 04-JUL-85
11. **Change Number:** 7
12. **Submitter Rank:** MSG
13. **Submitter FName:** Joe
14. **Submitter MName:** T
15. **Submitter LName:** Smith
16. **Submitter Phone:** 123-123-1234
17. **Problem:** 1
18. **Page:** 2
19. **Paragraph:** 3
20. **Line:** 4
21. **NSN:** 5
22. **Reference:** 6
23. **Figure:** 7
24. **Table:** 8
25. **Item:** 9
26. **Total:** 123
27. **Text:**

This is the text for the problem below line 27.



THEN ... JOT DOWN THE DOPE ABOUT IT ON THIS FORM, CAREFULLY TEAR IT OUT, FOLD IT AND DROP IT IN THE MAIL!

# SOMETHING WRONG WITH THIS PUBLICATION?

FROM: (PRINT YOUR UNIT'S COMPLETE ADDRESS)

PFC John DOE  
CO 4 3rd Engineer Bn  
Ft. Leonardwood, MD 63108

DATE SENT

10 January 1999

PUBLICATION NUMBER

TM 1-1520-240-10

PUBLICATION DATE

30 December 1998

PUBLICATION TITLE

Operator's manual CH47 Helicopter

BE EXACT PIN-POINT WHERE IT IS

IN THIS SPACE, TELL WHAT IS WRONG AND WHAT SHOULD BE DONE ABOUT IT:

PAGE NO	PARA-GRAPH	FIGURE NO	TABLE NO
6	2-1 a		
B1		4-3	

In line 6 of paragraph 2-1a the manual states the engine has 6 cylinders. The engine on my set only has 4 cylinders. Change the manual to show 4 cylinders.

Callout 16 in figure 4-3 is pointed at a bolt. In key to figure 4-3, item 16 is called a shim. Please correct one or the other

PRINTED NAME, GRADE OR TITLE, AND TELEPHONE NUMBER

JOHN DOE, PFC (268) 317-7111

SIGN HERE

JOHN DOE *John Doe*





THEN ... JOT DOWN THE DOPE ABOUT IT ON THIS FORM, CAREFULLY TEAR IT OUT, FOLD IT AND DROP IT IN THE MAIL!

# SOMETHING WRONG WITH THIS PUBLICATION?

FROM: (PRINT YOUR UNIT'S COMPLETE ADDRESS)

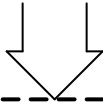
DATE SENT

PUBLICATION NUMBER	PUBLICATION DATE	PUBLICATION TITLE
--------------------	------------------	-------------------

BE EXACT PIN-POINT WHERE IT IS				IN THIS SPACE, TELL WHAT IS WRONG AND WHAT SHOULD BE DONE ABOUT IT:
PAGE NO	PARA-GRAPH	FIGURE NO	TABLE NO	

PRINTED NAME, GRADE OR TITLE, AND TELEPHONE NUMBER	SIGN HERE
--	-----------

FILL IN YOUR  
UNITS ADDRESS



FOLD BACK

DEPARTMENT OF THE ARMY

---

---

OFFICIAL BUSINESS

COMMANDER  
U.S. ARMY AVIATION AND MISSILE COMMAND  
ATTN: AMSAM-MMC-MA-NP  
REDSTONE ARSENAL, AL 35898-5230

TEAR ALONG PERFORATED LINE



# SOMETHING WRONG WITH THIS PUBLICATION?

THEN ...JOT DOWN THE DOPE ABOUT IT ON THIS FORM, CAREFULLY TEAR IT OUT, FOLD IT AND DROP IT IN THE MAIL!

FROM: (PRINT YOUR UNIT'S COMPLETE ADDRESS)

DATE SENT

PUBLICATION NUMBER

PUBLICATION DATE

PUBLICATION TITLE

BE EXACT PIN-POINT WHERE IT IS

IN THIS SPACE, TELL WHAT IS WRONG AND WHAT SHOULD BE DONE ABOUT IT:

PAGE NO

PARA-GRAPH

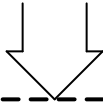
FIGURE NO

TABLE NO

PRINTED NAME, GRADE OR TITLE, AND TELEPHONE NUMBER

SIGN HERE

FILL IN YOUR  
UNITS ADDRESS



FOLD BACK

DEPARTMENT OF THE ARMY

---

---

OFFICIAL BUSINESS

COMMANDER  
U.S. ARMY AVIATION AND MISSILE COMMAND  
ATTN: AMSAM-MMC-MA-NP  
REDSTONE ARSENAL, AL 35898-5230

TEAR ALONG PERFORATED LINE



THEN ... JOT DOWN THE DOPE ABOUT IT ON THIS FORM, CAREFULLY TEAR IT OUT, FOLD IT AND DROP IT IN THE MAIL!

# SOMETHING WRONG WITH THIS PUBLICATION?

FROM: (PRINT YOUR UNIT'S COMPLETE ADDRESS)

DATE SENT

PUBLICATION NUMBER

PUBLICATION DATE

PUBLICATION TITLE

BE EXACT PIN-POINT WHERE IT IS

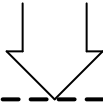
IN THIS SPACE, TELL WHAT IS WRONG AND WHAT SHOULD BE DONE ABOUT IT:

PAGE NO	PARA-GRAPH	FIGURE NO	TABLE NO

PRINTED NAME, GRADE OR TITLE, AND TELEPHONE NUMBER

SIGN HERE

FILL IN YOUR  
UNITS ADDRESS



FOLD BACK

DEPARTMENT OF THE ARMY

---

---

OFFICIAL BUSINESS

COMMANDER  
U.S. ARMY AVIATION AND MISSILE COMMAND  
ATTN: AMSAM-MMC-MA-NP  
REDSTONE ARSENAL, AL 35898-5230

TEAR ALONG PERFORATED LINE

## The Metric System and Equivalents

### Linear Measure

1 centimeter = 10 millimeters = .39 inch  
 1 decimeter = 10 centimeters = 3.94 inches  
 1 meter = 10 decimeters = 39.37 inches  
 1 dekameter = 10 meters = 32.8 feet  
 1 hectometer = 10 dekameters = 328.08 feet  
 1 kilometer = 10 hectometers = 3,280.8 feet

### Weights

1 centigram = 10 milligrams = .15 grain  
 1 decigram = 10 centigrams = 1.54 grains  
 1 gram = 10 decigrams = .035 ounce  
 1 decagram = 10 grams = .35 ounce  
 1 hectogram = 10 decagrams = 3.52 ounces  
 1 kilogram = 10 hectograms = 2.2 pounds  
 1 quintal = 100 kilograms = 220.46 pounds  
 1 metric ton = 10 quintals = 1.1 short tons

### Liquid Measure

1 centiliter = 10 milliliters = .34 fl. ounce  
 1 deciliter = 10 centiliters = 3.38 fl. ounces  
 1 liter = 10 deciliters = 33.81 fl. ounces  
 1 dekaliter = 10 liters = 2.64 gallons  
 1 hectoliter = 10 dekaliters = 26.42 gallons  
 1 kiloliter = 10 hectoliters = 264.18 gallons

### Square Measure

1 sq. centimeter = 100 sq. millimeters = .155 sq. inch  
 1 sq. decimeter = 100 sq. centimeters = 15.5 sq. inches  
 1 sq. meter (centare) = 100 sq. decimeters = 10.76 sq. feet  
 1 sq. dekameter (are) = 100 sq. meters = 1,076.4 sq. feet  
 1 sq. hectometer (hectare) = 100 sq. dekameters = 2.47 acres  
 1 sq. kilometer = 100 sq. hectometers = .386 sq. mile

### Cubic Measure

1 cu. centimeter = 1000 cu. millimeters = .06 cu. inch  
 1 cu. decimeter = 1000 cu. centimeters = 61.02 cu. inches  
 1 cu. meter = 1000 cu. decimeters = 35.31 cu. feet

## Approximate Conversion Factors

To change	To	Multiply by	To change	To	Multiply by
inches	centimeters	2.540	ounce-inches	Newton-meters	.007062
feet	meters	.305	centimeters	inches	.394
yards	meters	.914	meters	feet	3.280
miles	kilometers	1.609	meters	yards	1.094
square inches	square centimeters	6.451	kilometers	miles	.621
square feet	square meters	.093	square centimeters	square inches	.155
square yards	square meters	.836	square meters	square feet	10.764
square miles	square kilometers	2.590	square meters	square yards	1.196
acres	square hectometers	.405	square kilometers	square miles	.386
cubic feet	cubic meters	.028	square hectometers	acres	2.471
cubic yards	cubic meters	.765	cubic meters	cubic feet	35.315
fluid ounces	milliliters	29.573	cubic meters	cubic yards	1.308
pints	liters	.473	milliliters	fluid ounces	.034
quarts	liters	.946	liters	pints	2.113
gallons	liters	3.785	liters	quarts	1.057
ounces	grams	28.349	liters	gallons	.264
pounds	kilograms	.454	grams	ounces	.035
short tons	metric tons	.907	kilograms	pounds	2.205
pound-feet	Newton-meters	1.356	metric tons	short tons	1.102
pound-inches	Newton-meters	.11296			

## Temperature (Exact)

F	Fahrenheit temperature	5/9 (after subtracting 32)	Celsius temperature	C
---	------------------------	----------------------------	---------------------	---

